

# AMATEUR RADIO

JANUARY  
1947

JOURNAL OF THE WIRELESS INSTITUTE OF AUSTRALIA

## for your Mixer Socket

A new Frequency Changer Valve—Philips ECH35—is due for early release. This valve—a triode-hexode type—will be of particular interest to amateurs planning new receivers.

### RATINGS:

Heater volts	6.3
Heater current	0.3 amps.
Plate	250 volts
Plate current	3.0mA.
Neg. grid bias	-2 to -23 volts
Grids 2 + 4 (screen)	100 volts
Screen current	3.0mA.
Conversion Slope	650 $\mu$ A/V.
Plate resistance	1.3 meg.
Osc. anode 100V.	3.3 mA.
Osc. grid current	0.2mA.
Osc. grid resistor	50,000 ohms
Osc. slope	2.8 mA/V.

Incandescent and Fluorescent Lamps; Lighting Equipment and Fittings; Radio Receiving and Transmitting Valves; Radioplayers; Radio Transmitters; Sound Systems; Medical and Industrial X-Ray and Electro-Medical Equipment; Industrial and Medical Infra-Red Apparatus; Electronic Devices; Radio Accessories; Electrical Measuring Instruments; Metal Pressings and Stampings.



## PHILIPS

Philips Electrical Industries of Australia Pty. Ltd.  
Sydney — Melbourne — Adelaide — Perth — Brisbane

PL11-44



FOR THE EXPERIMENTER & RADIO ENTHUSIAST

Registered at G.P.O., Melbourne, for transmission by post as a periodical.

6<sup>d.</sup>

KKI

## THIS IS THE FAMOUS FERROTUNE FOUNDATION KIT

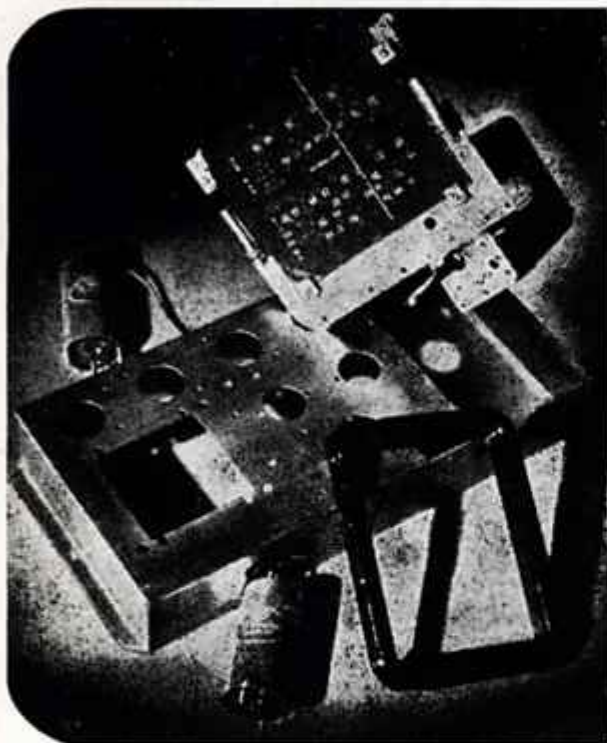

**K**INGSLEY RADIO brings all amateur self-builders a FOUNDATION KIT that makes any predecessors completely out-of-date.

The FERROTUNE FOUNDATION KIT is based on the revolutionary IRON-CORE TUNING which KINGSLEY developed during the war years.

FERROTUNE brings you greater clarity of reception, faultless tuning of every broadcast frequency, increased coil I.F. gain and selectivity. Included in the FERROTUNE FOUNDATION KIT is . . .

1. The outstanding FERROTUNE ferromagnetic gangless tuning unit—it covers the broadcast band and includes tuning mechanism, straight line dial, padding and trimming, etc. It does not need further alignment.
2. Cadmium-plated steel chassis.
3. Two PERMACLAD I.F.'s which have exceptionally high "Q" ratings.
4. Complete attractive plastic escutcheon with glass window.

OBTAINABLE FROM  
AUTHORISED KINGSLEY DISTRIBUTORS

Ask your radio dealer for

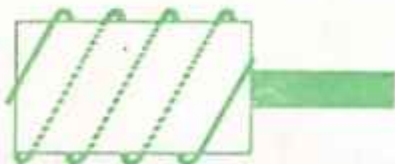

**F E R R O T U N E**  
FERRO-MAGNETIC IRON-CORE COILS, I.F.'s AND  
GANGLASS TUNING UNITS



# KINGSLEY RADIO

KINGSLEY RADIO PTY. LTD.

380 St. Kilda Road, Melbourne, Victoria . Phones: MX 1159, MX 3653

# AMATEUR RADIO

VOL. 15

JANUARY, 1947

No. 1

Published by

THE WIRELESS INSTITUTE  
OF AUSTRALIA

191 Queen St., Melbourne, C.1.

Editor:

T. D. HOGAN, VK3HX  
Phone: UM 1732

Technical Editor:

J. K. RIDGWAY, VK3CR

Distribution:

H. N. STEVENS, VK3JO

Business Manager:

J. G. MARSLAND, VK3NY

Advertising Representative:

W. J. LEWIS  
20 Queen St., Melbourne, C.1.

Printers:

H. Hearne & Co. Pty. Ltd.  
285 Latrobe St., Melbourne, C.1.

Mss. and Magazine Correspondence should be forwarded to the Editor, "Amateur Radio," Box 2611 W.G.P.O., Melbourne, C.1. on or before the 18th of each month.

Subscription rate is 6/- per annum in advance (post paid).

## Editorial

There seems to be some confusion in certain quarters concerning the administrative set-up of the W.I.A. Since this confusion appears to exist rather more outside the Institute than within its ranks, we might, if we felt so uncharitable, consider that it is more deliberate than accidental.

Acting upon the old adage, "if you don't tell 'em you can't expect them to know," let us review the facts. Firstly the W.I.A. is thoroughly democratic—any member may, if he is willing to devote his energies to helping his fellow members, attain the highest office in the Institute, subject of course to geographical circumstances in the case of Federal Executive posts. Likewise any member has the equal right with all other members to express his opinion at meetings, or through "Amateur Radio," on any subject of concern to Hams.

Let us banish once and for all the old fiction that the Institute is under the control of some remote clique referred to as "F.H.Q." This Institute never has, and, we trust, never will be so controlled. The plain truth is that the whole governing power rests with the members.

The organisation of the W.I.A. is analogous to that of the States and the Commonwealth of Australia, the members being the electors, the Divisional Councils the State Parliaments, the Federal Council the Federal Parliament, and the Federal Executive, like the Commonwealth Executive Council, is empowered only to carry out the will of the Federal Council. The sole vital point of difference is that while there are within the W.I.A. both conservatives and radicals in profusion, there are no parties, no "haves" and "have-nots," all being Hams, and therefore fundamentally equal.

So close is this analogy that in drafting the new Federal Constitution of the W.I.A. we have used

(Continued on page 11)

## IN THIS ISSUE

"The Terrific Two Watter" .....	3
"From Junkbox to 166 Megs." .....	4
Broadcast Interference from Amateur Stations .....	5
Novel Filament Circuit for D.C. Areas .....	6
Ramblings on the DX Bands .....	8
Fifty and Up .....	8
QSL Bureau .....	11
Federal Headquarters .....	12

## DIVISIONAL NOTES—

New South Wales .....	13
Victoria .....	13
Queensland .....	14
South Australia .....	17
Tasmania .....	18
Electronics .....	22

# RADIO ENTHUSIASTS!

# SEE THESE STAR SPECIALS AT HOMECRAFTS!

- ★ **EIMAC TRANSMITTING TUBES.** Write for new Characteristics Handbook.
- ★ **DISPOSALS BARGAIN.** F.S.6 Transceivers, Remote Controls, Parts, etc.
- ★ **QUARTZ CRYSTALS.** A big selection at reasonable prices.
- ★ **HOMECRAFTS VALVE CHART.** A huge wall chart giving instant reference to all characteristics.
- ★ **AUSTRALIA'S WIDEST RANGE OF RADIO PARTS.**

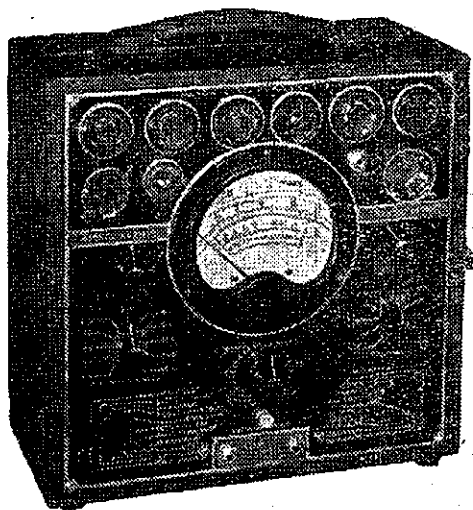

## "PALEC" TEST EQUIPMENT

**VCT TESTER** Operates from 50 cycle A.C. mains with voltage from 200 to 250. Sturdy construction for lifetime service 11" x 7". Weight 16½ lbs. Also available in battery operated model.

**NEW OSCILLATORS NOW AVAILABLE WITH OUTPUT METER.**

**YOU'LL SEE IT SOON — HOMECRAFTS CATALOGUE FOR 1947**

*The Radio Specialists*

# HOMECRAFTS PTY. LTD.

Head Office:—MELBOURNE. 290 Lonsdale Street and at 211 Swanston Street, Melbourne.  
139 Moorabool Street, GEELONG. 307 Sturt Street, BALLARAT. 100 Clarence Street,  
SYDNEY. 26 Hunter Street, NEWCASTLE. Hobart, Launceston and Burnie, TASMANIA.

**IF IT'S ELECTRICAL — TRY HOMECRAFTS FIRST!**

# "THE TERRIFIC TWO WATTER"

BY D. A. GREENHAM, VK3CO\*

During the past few years the work of Trunk Line testing and measurements has carried the author to all parts of the State and after the resumption of amateur activities the idea of carrying a portable rig naturally was in the forefront. Early this year, after the release of the 28 Mc. band, a small portable was built to operate on that band. Due to the forced use of batteries the power was very small, in the vicinity of 3 watts. The set-up on 28 Mc. consisted of a 6V6G as an ECO on 14 Mc., doubling in its plate circuit, driving a 6V6G as a straight anal. The plate supply was derived from a 135 volts bank of B batteries.

The receiver was a 6J7G regen-det. driving a 6J7G as audio stage. This set up was used from the test van and quite good success was had. The antenna used in these operations depended largely on the facilities available. Trees, post office clock towers, telephone poles, fences, or any other prominent object above the ground level is always an antenna possibility. Some months ago when

for many miles, the contacts possible after skip failure were absolutely nil.

After the release of the 7 Mc. band the gear was changed to operate in that band with the same tubes—6V6G ECO on 3.5 Mc. and 6V6G PA. The receiver was left as 6J7G det. and 6J7G audio. The gear is operating in that condition at the present moment with the addition of a modulator for phone operation. The modulator consists of an amplifier with a speaker incorporated, which makes it either a modulator or an amplifier to add to the receiver. A single button carbon mike is also fitted in the unit so that normally the unit is an amplifier ending on a 5-inch permag. speaker. On the operation of a switch the mike is excited and placed on the input of the amplifier and the output is brought out to terminals via line transformer. This can be connected to the line transformer in the plate and screen circuit of the 6V6G final amplifier. The amplifier-modulator unit consists of a 6J7G resistance capacity coupled to a 6V6G.

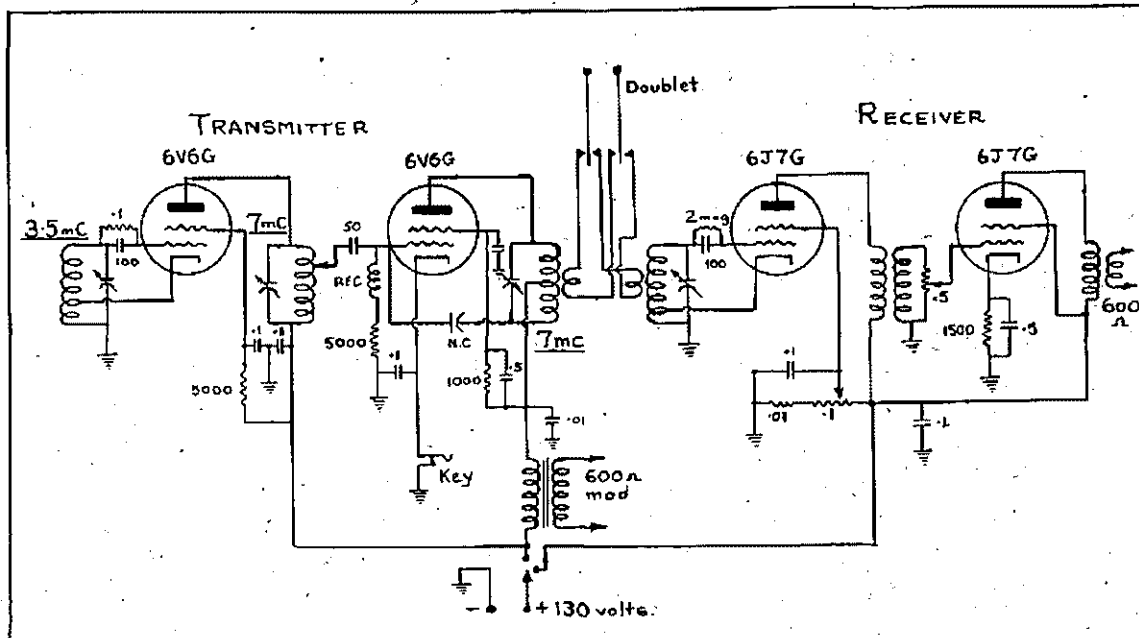

operating from Euroa and Wangaratta VK6 was worked with an R7 report and also ZL4 with an R7/8 report which is very encouraging with such a small set-up. The shortest distance worked was whilst at Wangaratta, the "shack" was parked outside the front gate of VK3YV and a contact was made on 28 Mc. over a distance of 50 yards! To prove the connection QSL cards were exchanged there and then with Howard, the OM of that station.

The main limitations however were found to be the frequency used and the low power. When the station was operated in a town where there were no local stations

On the 7 Mc. band the antenna problem is increased due to the larger physical length but the added improvement of the whole equipment is certainly worth the extra effort in installation. At the time of writing the equipment is in use at Geelong and very pleasing results have been obtained into VK2, 3, 4, 5 and 7, and also over to ZL. The band conditions at the moment make operation difficult during "peak periods" owing to the higher power QRM, but with careful operating and waiting until the time is right, very solid contacts have been made.

The circuit of the unit is shown and the whole unit, receiver and transmitter, is mounted on one chassis with a single send-receive switch. The unit has only the bare

(Continued on Page 21)

\*35 Bertram Street, Gardenvale, S.4, Victoria.

# FROM JUNKBOX TO 166 MEGS.

BY J. COULTER, VK5JD\*

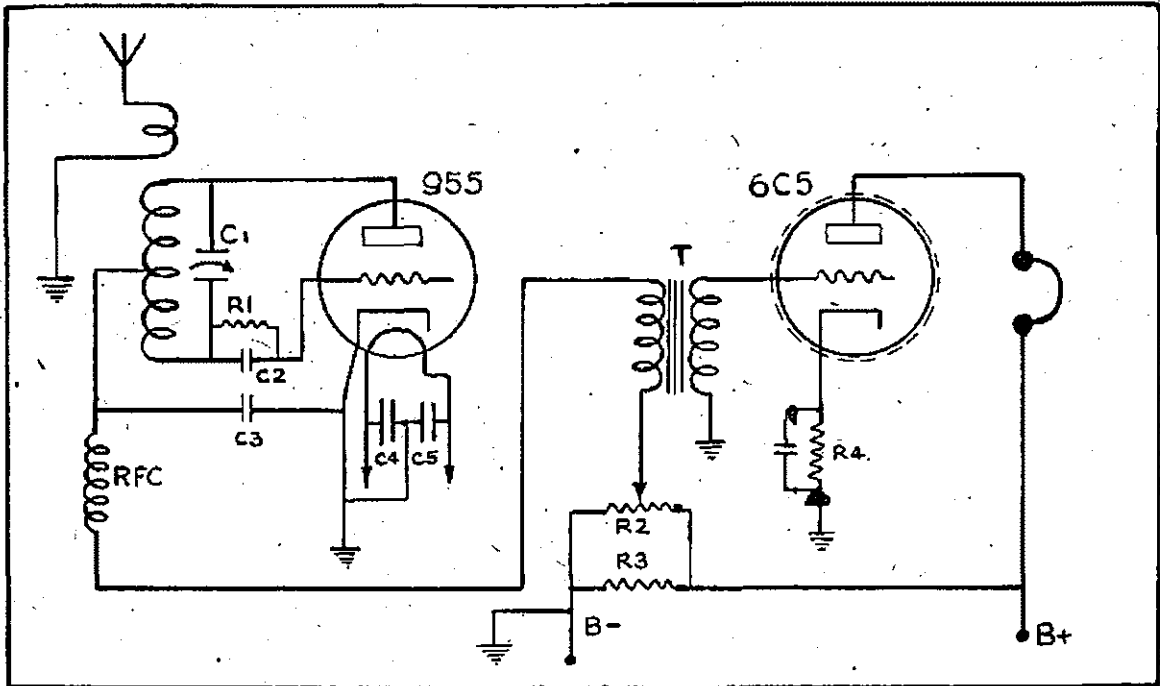

It's quite a jump from the junkbox to 166 and it might be thought impossible, but that is not so. With a little re-vamping and a bit of "polly," much can be achieved. Further, all the material used was obtained in VK, a big advantage when breaking new ground.

Two receivers have been constructed and put in operation, with satisfactory results. Detectors in both are identical, but the second is built on a smaller chassis and more attention was paid to the appearance.

Before proceeding with the construction, a few observations may be in order. The bracket which supports the 955 might be termed the "detector chassis" as all earths (the whole three of them) are made to a single point on this bracket. Previous to making the detector earths to this point, regeneration was very patchy.

The value of the plate bypass appears to be critical and it is possible that other constructors may find another value more suitable.

It seems most desirable that the antenna coupling be variable and for greatest convenience a control has been brought out to the front panel. No doubt there are other and perhaps better mechanical arrangements than that described.

The tuning condenser is a re-vamped "Wetless," well remembered by the not-so-old-timers. First, the condenser is stripped down and the insulation replaced with strips of polystyrene. All the fixed plates are removed, with the exception of the second from the front and the second from the rear. Having done this, both mounting bars are cut in the centre and filed clean. The rotor is stripped down until there are but four plates, two of

- L1—2 turns, 7/16-inch diam.
- L2—4 turns, 7/16-inch diam.
- C1—Split stator (rotors floating)
- C2—50 mmfd.
- C3—250 mmfd.
- C4, C5—100 mmfd.
- C6—10 mfd.
- R1—5 Meg.
- R2—50,000 Ohms.
- R3—20,000 Ohms.
- R4—2,000 Ohms.
- T—3-1 ratio.
- RFC— $\frac{1}{2}$  wave, 20 gauge, wound on pencil.

which enmesh the front stator and two the rear stator. An examination of the attached sketch will, perhaps, make this clearer. The result is a split stator condenser of very small capacity. Incidentally, with this condenser, the bandspread is approximately 150 degrees on 166 Mc.

The most suitable antenna seems to vary. At Seaton Park signals from VK5GF, approximately 11 miles distant, could be read on most any piece of wire. Best results being obtained on a half-wave 60 feet up. However, things were much different at the writer's QTH and it was three weeks before signals were copied.

## CONSTRUCTION

The main chassis is constructed from a piece of aluminium 13 inches by 6 inches, bent and cut as shown in the diagram. The panel measures 10 $\frac{1}{2}$  inches by 7 inches and is secured to the chassis by means of a piece of  $\frac{1}{2}$  inch aluminium, angle along the front edge and by

(Continued on Page 21)

\*49 Farnham Road, Ashford, S.A.

# BROADCAST INTERFERENCE FROM AMATEUR STATIONS

BY DES. GREENHAM, VK3CO\*

Since the return of the 3.5, 7 and 14 Mc. amateur bands the problem of Broadcast Interference (BCL) becomes a serious reality in built-up residential areas. It is proposed in this article to deal with the different forms of interference, methods of location and methods of elimination.

The first and most common form of BCL trouble is called "blanketing." This is usually found in simple type receivers such as the crystal set, Reinartz one and two tube sets, and the more complicated TRF set. The reason for this is that the field strength of the interfering signal is so great that the tuned grid circuit of the detector valve cannot completely eliminate it. This causes a small voltage of the amateur station frequency to be applied to the detector stage and the audio component is heard all over the tuning range of the receiver.

The second form of interference is received through the AC supply mains and detected in the detector stage or in some cases detected in the audio section of the receiver. The third and most stubborn of cases is picked up by the wiring in TRF and super-het. receivers.

After the amateur has been informed either by the Radio Inspector or direct by the listener it is advisable to keep off the air until action can be taken. The most effective method of testing is to arrange with the listener a suitable time when they have no special programme to hear. The amateur should then have some one to operate his station, a fellow amateur, if possible, and listen to the interference. The first test should be to ascertain if the signal can be tuned. If so, then the interference is not blanketing but definite pickup either from the antenna or earth or the set wiring. If it cannot be tuned and is all over the tuning range then it is a case of blanketing or pickup in some stage following the tuned RF stages.

The next test is to remove the antenna from the receiver. If the signal disappears it is picked up from the antenna and the remedy is relatively simple. If it does not it is possibly coming in through the AC supply mains. In this case an RF filter is needed to check this source. This will be described later.

In cases where the interference is being picked up in the set itself then the wiring should be inspected for long unshielded leads, unshielded high gain tubes, or unshielded coils. One very elusive form of interference is that brought about by the detector action of a faulty wire connection in the preamplifier stage of the audio section. Interference in superhet receivers often appears in the form of several "spots" on the tuning range. These "spots" can be subharmonics of the transmitters or can be due to pickup in leads as mentioned previously.

The simplest form of interference, i.e., blanketing of a simple receiver from an outdoor antenna can often be eliminated by the insertion of a low inductance RF choke in the antenna lead as shown in Figure 1.

If the interference is fairly low the method shown in Figure 1 will often completely eliminate all traces. This method is rather detrimental to the performance of the short wave section of a dual wave receiver.

In cases where the interference is more severe and the choke method does not completely eliminate the trouble, then further steps must be taken. The next method is the use of a parallel tuned "wave-trap" in the antenna. Before attempting to adjust the wave-trap it should be checked for resonance. This can easily be done by placing the coil close to the final tank coil of the transmitter and tuning the wave-trap until an increase in plate current is noticed. This should take place when the trap tuning condenser is in about half mesh so as to allow for adjust-

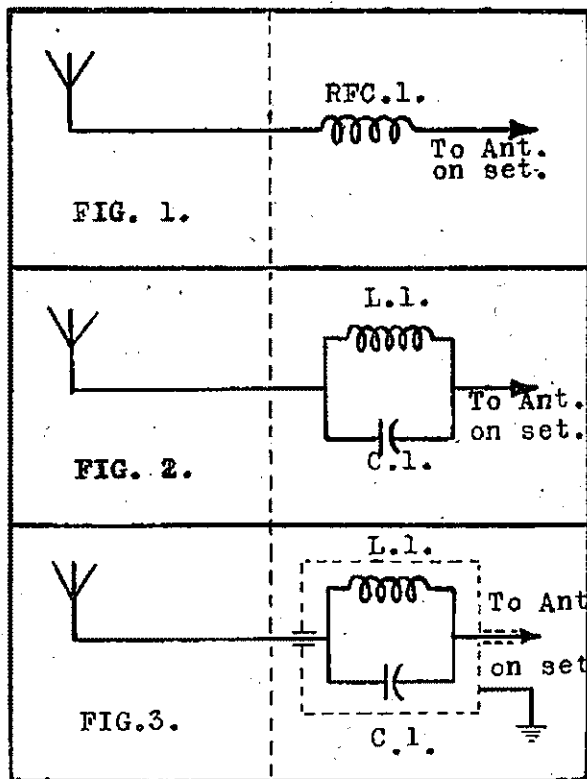

ment either way. The trap should be installed as shown in Figure 2.

When it is first installed and is not tuned the interference is increased and this may tend to alarm the operator but by carefully tuning the condenser the signal will completely disappear and the wave-trap should be set at that value and left. Care should be exercised in the placing of the unit so as it will not be knocked by the housewife in her cleaning duties. It is also advisable to place it under the chassis shelf so that curious listeners cannot interfere with the adjustment. This method is very effective but it has the disadvantage that if the transmitter frequency is changed the trap is no longer effective. On dual-wave receivers the short wave section still operates on all frequencies except for a few kilocycles either side of the wave-trap resonant frequency. This is not a very serious disadvantage however. In some cases where the interfering signal strength is very high it is often necessary to shield the wave-trap and earth the shield. The lead from the trap to the receiver terminals should be braided cable to prevent RF pickup as shown in Figure 3.

In cases where the pickup is due to set wiring, the method is to examine the set's stages in turn and ascertain which stage is causing the pickup. It is then a matter of trial and error to see the actual cause of the pickup, whether it be unshielded coils, leads, or tubes.

In cases where the station operates on more than one band and interference occurs on more than one band, it

\*35 Bertram Street, Gardenvale, S.4, Victoria.

then may require a trap for each frequency concerned. These can be mounted together and each tuned as shown in Figure 4.

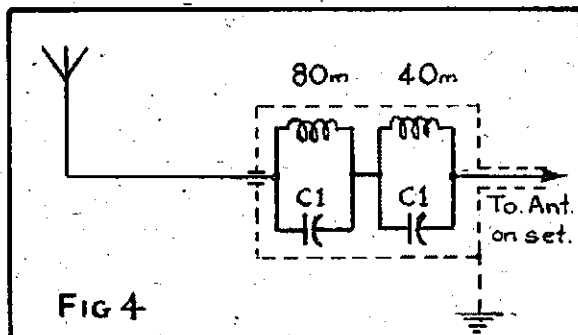

FIG 4

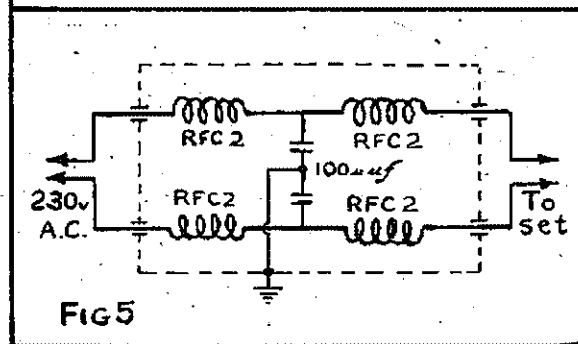

FIG 5

In some rare cases where high outdoor antennas are used on BCL sets and the length is resonant at the transmitted frequency i.e.  $\frac{1}{2}$ ,  $\frac{1}{4}$ , or 1 wave length, then the pickup is very severe. In these cases it is advisable with the listener's consent, to shorten the antenna. If this is not convenient or the listener objects, then a small value condenser in series with the antenna, or from antenna to earth, will alter its resonant frequency and reduce pickup.

Referring back to the AC mains type of interference it is quite a sound scheme for an amateur station to carry a small RF line filter for test purposes. The supply mains to the transmitter should be fitted with an RF filter to prevent any transmission back over the lines. In cases where line pickup is causing the interference then the RF filter should be fitted in the listener's set. The filter is shown in Figure 5.

Values for Figures 2-4 are tabulated below:—

M/c.	3.5	7	14	28	
L1	30	16	10	4	Turns $1\frac{1}{2}$ " diam.
C1	.0005*	.0005*	.0005*	.0001	Mfd.

\*Any type of broadcast tuning condenser is suitable.

A convenient method is to wind coils on valve bases with the pins removed and screw the base on the condenser itself. The turns shown in the table are for average sized tube bases. In shielding the wave-trap care should be exercised in mounting the condenser as the shaft is not connected to the shield. Insulating bushes should be used. One form of interference is that which occurs into the telephone lines. This appears very pronounced on the old types of telephone installations. It has been known to be of such a volume as to be louder than the telephone conversation. This condition is brought about by pickup from the aerial telephone wires and a detection action by the carbon granules in the telephone transmitter (microphone) circuit. This is a matter for

(Continued on Page 22)

## NOVEL FILAMENT CIRCUIT FOR DC AREAS.

By S. ZEUNERT VK3SZ

The Ham in the DC supplied town is always at a disadvantage mainly because of two things:—

(a) Filament voltage for tubes taking more than 3 amp. each is hard to obtain.

(b) Plate voltage is necessarily limited.

This hint is designed to overcome the disadvantage mentioned at (a). Tubes of the 6L6, 807 class work reasonably well on a plate voltage of 230 but their heater demands a current of .9 amp. at a voltage of 6 volts. This can be easily obtained with a suitable series resistance. However, as DC town Hams know only too well, no fixed series resistance in a filament circuit is of much use because of violent voltage fluctuations, especially at night.

By use of a type 302 barretter, which is a current regulating device, the current flowing through the heater of the valve can be accurately maintained over a wide variation in mains voltage. However the 302 is a 300 millamp. barretter and ordinarily can be used only with valves drawing 3 amp. or less, those valves drawing less being shunted with a resistance of suitable value.

In the circuit shown it will be seen that 3 barretter lamps are used, one in series with the valve heaters of the modulator, one for the 3 amp. heaters of the transmitter and one for the receiver. The "ends" of these three circuits are then connected in parallel, .9 amp. will be flowing through each "leg" of the circuit, therefore we can place the heaters of our 807s, 6L6Gs in one leg and we have .9 amp. flowing through them, .9 of amp. which is automatically regulated by the barretters.

By "suitable" switching we can arrange for any one unit to be "on" while the others are off. Only when all

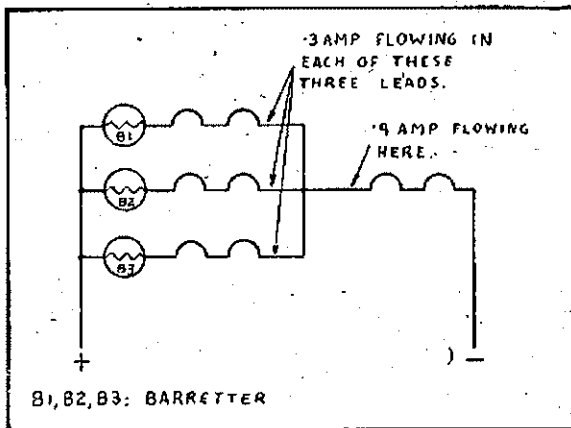

Figure 1—Theoretical Arrangement.

units are operating can the 807s, 6L6Gs be used of course. If only 2 units were on and the 6L6Gs allowed in circuit they (6L6Gs) would only have .6 amp. flowing through them. It is better therefore, to arrange that when any one unit is switched off it automatically shorts out the 6L6G, 807s. This is accomplished by using SPDT switches in all 3 units.

The result could also be achieved by using a single switch across the 6L6Gs and 807s and using ordinary single circuit switches in each unit. However, this arrangement is not recommended as through an oversight, this switch may be neglected to be used, consequently the 6L6G, 807s may be operated at lower heater potential (while one unit is off) and the HT accidentally turned

(Continued on Page 21)



# PROFESSIONAL EQUIPMENT

*for the Amateur!*

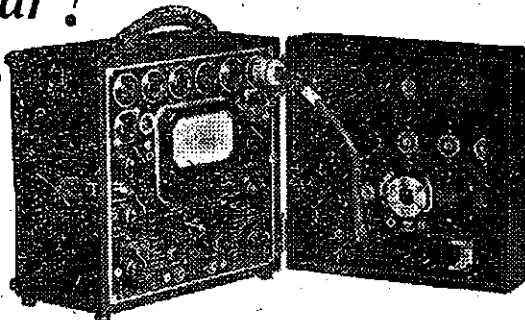

Double contact Relays, 24 volts, 30 ohms. . . . . 2/6 ea.

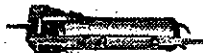

Drop Shutter Indicator, No. 500A, without drop lid. Internal resistance 1000 ohms. 2/6 ea.



"Young-atom" magnetic pick-up, all plastic, available in black, mahogany, walnut, wino, 77/6.X Co-axial cable beaded in 60 ft. lengths. Special offer 10/- per length.

Stylon G.P. liquid insulating cement, for sealing ends of above, 3/- Bottle.

Yaxloy wave change switch. 2 bank, single sided, 4 position, 2/6.

**TRANPRO Valve and Circuit Tester.** This compact and convenient tester will be found not only necessary to Radio Servicemen, but also to Radio experimenters.

Reads Milliamperes, D.C. & A.C. Volts, output volts and test resistors, condensers and valves. New model incorporating Button and Loctal Sockets. Operates from 230 A.C. or 6 volt battery.

£32-19-6 plus tax

Prices listed in this advertisement are not subject to usual hams discount except where marked thus X.

**SOUTH OF THE YARRA HAMS!**

Keep on the beam by making our Prahran Store your headquarters . . .

Contact VK3FR (Fred Smith)



Double Circuit Jacks . . . . 6d.



Flexible aluminium conduit with meshed shielding. Internal diameter 3/4". Outside diameter 7/8". in original lengths of approx. 50 ft. each . . . . 3d. per foot.



"Dynacard" High Fidelity moving coil microphone. The ultimate in professional standard dynamic microphones - £16-10-0.X

Morso Key (Army type). A first class compact instrument 7/6.

Brown's English lightweight headphones . . . . . 33/9 pair.X

**RADIO AND REFRIGERATORS**      **VEALLS**      **ELECTRICAL AND LIGHTING**

*Sales and Service*      MELBOURNE: VEALLS (SWANSTON ST.) PTY. LTD.      Telephone *F 3145*

243 SWANSTON ST., MELBOURNE

    PRAHRAN: VEALLS (PRAHRAN) PTY. LTD.

    239 CHAPEL ST., PRAHRAN

MAIL ORDERS: BOX 2111

## RAMBLINGS ON THE DX BANDS

It seems that the notes for this month are practically non-existent due to the lack of interest by those of you who concentrate on the working of DX.

No doubt many of you have made your New Year Resolution to send along notes of your various doings on the DX bands, so we can look forward to good notes under this heading in the future.

Snow Harrison, VK3CN at Shepparton, sends us some very interesting dope and says that he was "QSO G3AVK a few days ago and he asked that I put a par in 'Amateur Radio' to the effect that he used to be VK5RN and is now on the air as G3AVK. Frequency when I worked him was about 14165. Thought you might be able to incorporate the dope in your notes. Told him I would pass it along.

"Am always interested in your notes, being a DX fiend myself. However I am only on 14 Mc. and as you do not seem to be getting much dope on that band, here's some that may help other 14 Mc. band CW enthusiasts.

"Conditions have been patchy the last couple of weeks and not as good as they were a couple of months ago. However, there's still plenty of DX to be worked. Have worked the following during the past month as well as numbers of Europeans and sundry others:—LZ1XX on 14090 Kc., VS9AN 14130, FT4AE 14180, OQ5JF 14190, VQ2GW 14060, HK3CX 14080, ET1JJ 14040, VQ3HJP 14120, EP3D 14180, EP1AL 14070, AC4YN 14130, ST2AM 14010, CN8BK 14120, XABU (Rhodes, Dodecanese) 14130, T1NS (Tripoli, North Africa) 14120, OA4O 14180; and the best of the stations I have been unable to raise are: HZ1AB 14060, TF3A 14130, EA9AI 14150, ZB1M 14190, FF8AA 14080, G5KW/HZ 14120, MACY (Sp. Morocco) 14130, and the following I didn't take a note of frequencies: VO6K, VO2G, ET3Y, VP4TE, VP3FC, VP8D, OQ5BR, VS8AA, W6VKV/I6 (Eritrea), P11L, Y12FC.

"If anyone works EP3D and thinks they have a new country they will be disappointed as he is not in Iran. Had a letter from him and he says it is his old call and QTH Abadan, as he is waiting for a new call. However he is not far from there but doesn't want to run any risks of being caught so don't think we had better publish his QRA. Worked EP1AL the following morning so have my fingers crossed and hope he's dinkum, hi.

"The above frequencies are only approximate and refer to CW signs only, fone I don't listen to IF I can help it. Let me know if you want any more dope on 14Mc. at

any time. Am only too willing to be of any help I can." (Can always use such interesting dope as this "Snow"—Editor.)

George Choules VK3AHB claims to be a participant in the first duplex telephony QSO on the 28 Mc. band. He says that "It may be of interest to you that on Monday 9th December, a duplex telephony QSO took place on 28 Mc. between G2CDI and myself. As far as we know, this is the first occasion on which true duplex has been worked between this country and England on 28 Mc. and we have therefore awarded ourselves the proverbial 'Putty Medal.' The details are as follows:—Time 1225 GMT till 1245 GMT (10.30 p.m. our time). Frequency: G2CDI on 28.588 Mc., VK3AHB on 28.036 Mc. Power input: G2CDI, 25 watts; VK3AHB, 100 watts. Antennae: G2CDI three element beam plus  $\frac{1}{2}$  wave dipole for receiving; VK3AHB, four element beam plus  $\frac{1}{2}$  wave dipole for receiving.

"For the 20 minute duration of the duplex portion of the QSO the signals at each end were Q5 except for short periods of QSB. An interesting feature of this contact was the fact that at the moment when my signals were QSB, his were at good strength and vice-versa, indicating that the send and receive signal paths are not necessarily the same, probably due to different angles of incidence of the transmitted signals at the respective stations. In conclusion I wish to apologise in advance to any CW men who may have been inconvenienced by my signal in the CW portion of the band."

South Australia always sends us a short list of calls heard, which are apparently the choice ones. Signals heard on 14 Mc. included ZL2JI, VS1BX, VU2BT, XE1AG, LU5HF, C1YCS, VU2EG, VU2AM, SM5OU, HC1ON, PK6HA, G3TK, OZ3NO, J9AAB, J9AAA, KA1SS, J9ADT, XU1YR, CX2AX, XZ2AA, EI3J, TI2OA, OZ7UU, VP4TR, HK1AG, G8QX, J3HRP, G8MX, W6AWA/KH6, HC1JW, J2AAO, J3JNX, VS4RM, F3QG. Conditions on 14 Mc. were poor all the month; while signals heard on 28 Mc. included OZ3J, OA4AK, OA4AI, G4AJ, G2XA, G3VR, ON4BKC, G3TT, XZ2YT, EI3J, G5XK, G5PX, LX1SI, I1PB, W6ONT (KW6), ZS6IH, G3ADN, GM2FQG, W6BRR, W8ALB, W7DIZ (Iwo Jima), F3AT, VS1BJ, KH6FD, G4QB, G4JW, G2AMJ, VS1AE, G6WT, XZ2GP, VU2PG, G5CJ, PA0QJ, G4CY, G2AJ, VR8AP, PZ1A, and LA1F.

## FIFTY AND UP

As already reported, the band first opened for Interstate work on Thursday, 5th December. The following night it was dead but on Saturday 7th, signals came through at good strength again and a number of contacts were made between VK3s and VK2s and VK4s. On Sunday 8th, nothing was heard but on Monday 9th, a number of VK4s were worked here between 5.30 p.m. and 9.30 p.m. During these three openings, many good contacts were made and it is not possible for all stations and logs to be given in detail. 3MJ, 3GG, 3HK, 3YS, 3BW, 3LS and 3NW all did well.

Since that time no contacts were made until 25th December, although on quite a number of occasions VK4s were heard in Melbourne, weakly but quite Q5. On 25th, 3MJ worked 4FB at 11.15 a.m.—the first evidence of middle of the day skip. Then on 27th December starting at approximately 10.30 a.m. conditions again became very good and excellent signals were heard from 4ZU, 2AZ, 2NO and 2AHF. Unfortunately not many stations were active here or in Sydney or Brisbane. Good contacts were made but signals faded about 11.30 a.m.

Stations so far contacted in Melbourne are VK2s: NO, LZ, AZ, AHF, WJ; VK4s: AW, ZU, HR, XG, FB and RY. There has been a sudden burst of QSLing between these stations—seldom if ever before has such keen interest been shown in Interstate QSL cards!

Reports have been going about that a number of VK2s and VK3s have been heard in New Zealand and this appears quite definite now. However no details have reached me as yet. VK7CW reported hearing VK2NO and 2NP at good strength but unfortunately had no transmitter in operation to answer.

On Saturday 7th VK7LL was visiting 3MJ and took part in several very good Interstate contacts. "Doc" has returned to Hobart full of enthusiasm for 50 Mc., and we imagine, will stir up something in the "Apple Isle."

Letters received by 3HK and 3MJ from a listener in Bundaberg, Queensland, tell of signals received by him from 2NO, 2AHF, 2AZ and 4AW on Saturday 7th; 3MJ, 3BW, 3HK, 3NW, 2NO on Monday 9th (7-9 p.m.); 3HK and 3ABA on Friday 13th. The receiver is a 5 tube super. Of interest in this reporter's logging of 4AW 200 miles

*You cannot afford to omit PRICE'S RADIO  
from your buying list*

● **VALVES**

● **METERS**

● **CRYSTALS**

● **CONDENSERS**

And all those other parts that go to make a successful "Ham" transmitter and receiver, are now available, or on their way from overseas.

PLUS AN EFFICIENT TECHNICAL SERVICE — VK 2ZH IS AVAILABLE TO HELP YOU  
WITH YOUR PROBLEMS.

**PRICE'S RADIO 5 & 6 ANGEL PLACE  
SYDNEY, N.S.W.**

away. We wonder whether it is possibly line of sight conditions of ultra short skip for this frequency.

It is interesting to note that most of the VK2s and VK4s are using vertical antennas—some 2 element rotaries, but most just co-axial dipoles or ground plane types. As originally thought, little difference can be noted as far as the DX work is concerned although it would appear that stations here with 3 or 4 element beams are putting out stronger signals than the above mentioned VK2s and VK4s. Such beams also appear to give better reception.

One QSO of more than usual interest was between 3MJ and a VK4—the latter was operating portable with only 2 or 3 watts input and his sigs were R8!

A field day was held on Saturday, 21st December with the following stations taking part: 3NB at Mt. Dandenong, 3HK Mt. Donna Buang, 3YS Mt. Macedon, 3IV Mt. Bun- ingong, 3IZ Arthur's Seat, 3DH Frankston, 3NW Leon- gatha. Melbourne stations operating were 3MJ and 3KU. Signals from 3IV were heard at Mt. Dandenong and elsewhere but no contacts were made and apparently Keith was having receiver trouble. He was heard later by 3HK but Keith called without success. 3IZ had one contact and burnt out his vibrator supply! He then returned to his home at Red Hill and worked 3MJ and 3HK. 3HK contacted 3YS, 3NW, 3NB, 3MJ, 3LR and 3IZ. 3YS contacted 3HK, 3NB, 3LR, 3MJ, 3KU and heard 3ABG on CW from Avenel. 3NW contacted 3YS, 3HK, 3NB and heard 3MJ at Q5 R3/4. The longest distance covered was 3YS-3NW, 105 miles with signals Q5 R8 both ends. Unfortunately 3BW and 3BU were not able to participate. Thanks must be made to 3DI of Leon- gatha and his XYL for their hospitality and interest in the tests.

3IZ has at last got going and puts an R9 sig into Mel- bourne. He is very active and is heard most nights. No details of his rig as yet but he has a 3 or 4 element

beam functioning well. 3PK appeared using a portable outfit at Mornington. His signal in Melbourne is R8/9 and very nice quality but his modulation percentage was falling off during the course of each over. Colin has been a regular listener from his QTH in East Kew and when he returns from his holiday he will be on the air with his portable and later with a bigger rig. The portable consists of 6V6 tritet xtal osc, tripling and 6V6 doubler with an 807 doubling in the final. Input is 4 watts mod- ulated (plate) with a 6V6. His receiver employs a 954 RF and 954 Mixer.

3DH is now using a stabilised rig and his signal is good copy. Ivor had his transmitter in his car and on one occasion contacted 3MJ from a point about 200 yards away. Dave wondered why 3DH was so darn loud until things were explained!

Others heard fairly regularly are 3YJ, now free from BCL QRM, but keeping his fingers crossed, 3GG now on holidays at Mornington, 3ZD still with a zepp antenna, 3QO, 3HK, 3YS-3ABA who worked cross-band duplex with the writer 3NW, the latter being on 166 Mc. and Fred on 50 Mc., 3BW fairly busy with junior op., 3LS, 3KU, 3BD getting converter going and 3AJH and 3LR.

Clarry. VK5KL up in Darwin, in a recent letter says: "Thought I would drop you a line on the doings up here as I read 'A.R.' and know how hard it is to get news. Being pre-war ex-5 meter man xtal controlled, I naturally have turned to 50 Mc. Have got going on 28 and 50 Mc. up here now. 50 Mc. rig is 5 stages, PP final, 100 watts, 3 element rotary beam, R/T or MCW, receiver is 954 RF, 954 Mixer, 955 Osc. converter into 10 tube super.

"My nearest station is VK5NR, Noel Roberts, at Kath- erine 160 miles away, and we hope to QSO shortly. I operate 50 Mc. tests. I am endeavouring to arrange schedules with all States and N.Z. in an effort to QSO.

(Continued on Page 11)

# CONSTANT VOLTAGE FOR LABORATORY MEASUREMENTS

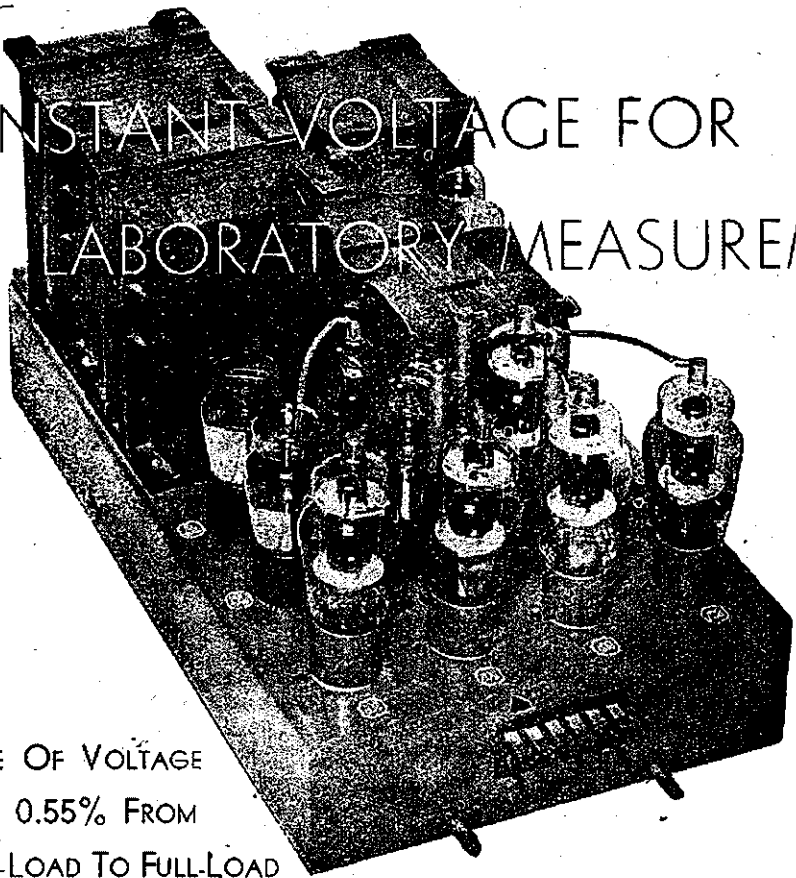

CHANGE OF VOLTAGE  
ONLY 0.55% FROM  
NO-LOAD TO FULL-LOAD

**M**ANY testing processes require constant voltage to be applied to valves or other equipment during the time that the test is in progress. It is useless to have instruments correct within 1% or less if the voltage is going to vary while the current or other feature is being read.

This is particularly important in the testing of radio valves in which some of the characteristics are critically dependent upon the applied voltages. An example of this is the Characteristic Tester recently constructed in the Laboratory of Amalgamated Wireless Valve Co. Pty. Ltd. at Ashfield. This equipment is used for the checking of a percentage of all valves manufactured each day, to see that the accuracy of the factory testing is maintained, and to carry out other tests not normally applied to the whole production owing to their complexity.

The equipment uses an electronic voltage regulator on the plate, screen and grid supply voltages. The input is from the 240 volt A.C. mains, the output is variable in voltage from 0 to 300 volts with a maximum current of 200 mA. With the maximum output voltage, the percentage voltage drop is only 0.55% for a change of load from 0 to 200 mA.

The equipment uses Radiotron type 807 valves, four of which carry the current of 200 mA, between them. The 807 is probably the most satisfactory type of

valve for this purpose owing to its high current capability (72 mA. per valve maximum) and its high amplification factor. This is only one of many applications in which Radiotron type 807 may be used with every satisfaction.



*Radiotron*  
MADE IN AUSTRALIA

## FEDERAL AND VICTORIAN QSL BUREAU.

As no list of VK9 stations appears in the official list of experimental stations, cards for VK9 have been held. The address of any station who can dispose of VK9 cards would be appreciated.

VR2UH, D. A. Leslie, Box 237, Suva, Fiji, intimates he is prepared to handle QSLs for VR2. He states that on 9th November, 1946, the only licenced Fiji stations were VR2AA, 2AB, 2AC, 2AD, 2AF, 2AG and 2AU. He is also desirous of contacting any VK resident in the Walgett district of N.S.W.

ZC1AR/ZC6, Palestine, writes to state that he is not a genuine ZC1 but is located in ZC6 where no licences were then issued. He is now licenced, as are other service Hams in Palestine. Frequencies allocated are 28, 56, and 112 Mc. with maximum input of 50 watts. Calls are four letter with no figures and commence with JX. At time of utilising the ZC1 call he was situated under cover near Jerusalem.

PK1VHN located in Batavia, Java, desires QSLs to be forwarded to him at his home QRA: W6VHN, Jim Houlahan, 11354 Biona Drive, Los Angeles, 34, Cal., U.S.A.

A card to hand from UA3AM has a nice pictorial representation of A. Popov, who UA3AM describes as "inventor of radio." The card came to hand via RSGB and a superscription probably added there and rightly too, reads "Sez You!"

PK1OKL, Batavia, Java, desires all wallpaper to go to his home address, Harry H. Ross, 1079 Marco Place, Venice, Calif. U.S.A.

A note from Mac VK3XZ, latterly of 3SR Shepparton, indicates big doings in the future but a postscript to the effect that all the big doings are contingent on completing the painting of his house, seems to push the big doings way down on the priority list. Mac is very enthusiastic about the November issue of Amateur Radio, especially the receiver featured in that issue and the article on I.F. frequencies.

Many thanks to the country hams who responded to the request in a recent issue for volunteers to distribute QSLs in provincial towns and cities.

Among the offers accepted are VK3BE for Ballarat, VK3EQ for Warrnambool, and VK3YV for Wangaratta.

V.E.R.O.N., the Netherland Association in its August bulletin, puts out a plea for spare parts for PA Hams. Quoting the bulletin "Owing to the fact that all Tx and Rx have been stolen by the Germans it is difficult for many Hams to restart on the air as in our country radio parts are very scarce and transmitting parts practically not available." The bulletin also mentions that 20 pre-war members were "shot by the Jerries."

The Danish bulletin for September enthuses over the return to OZ Hams of a portion of the 3.5 Mc. band which has created much activity. A Ham Camp held on the island of Laeso (in the Kattegat) during the second week in July was attended by 40 OZ and SM Hams. Combined with other outdoor pursuits the camp operated a 50 watt station, OZ7EDR.

The QSL Manager takes the opportunity of wishing Interstate colleagues a prosperous 1947 and grateful thanks for the smooth and efficient functioning of the State Bureaux.

Early in 1947, the annual "burning off" at the VK3 Bureau is due to commence and all cards unclaimed will be vetted and those having lain at the Bureau for over 6 months will participate.

As from 20/1/47 the writer is relinquishing the position of Victorian QSL Manager after 15 years, due to the heavy increase in the volume of QSL traffic. Interstate QSL Managers should note the new address in this col-

umn in February "Amateur Radio." Writer will continue to occupy the position of Federal QSL Manager.

Cards for stations in Japan should be sent to J4AAC, Major J. M. L. Drudge-Coates, Brindiv. Signals, B.C.O.F., Japan.

A card from KA1ABA relating to a phone QSO on 28 Mc. is to hand. It does not bear the name of the addressee station or date of QSO. Owner please apply this Bureau.

Thoyne S. Smuck, 154 Lynn Street, Seattle 9, Wash., U.S.A., writes requesting a contact with Australian philatelists or pen friends.

### EDITORIAL.

as a model the Constitution of the Commonwealth of Australia, acknowledged by those whose job it is to know as the best of its kind in the world.

We who comprise the Federal Executive (there is no "F.H.Q.") are justly proud of the honour conferred upon us by virtue of having been chosen for the task, at the same time we are not unmindful of the responsibility involved. We ask you in turn always to remember that should you feel that we have failed to obey your wishes you have the right to propose our removal.

Let those who prattle of "the F.H.Q. system" paste this on their soap boxes.

A.H.C.

### FIFTY AND UP.

Worked ZL1HY on 28 Mc. and he says that ZL1AO runs tests towards VK on 50 Mc. each Sunday at midday N.Z. time, and there is great interest in 50 Mc. in New Zealand.

"VK4AP reports great doings in VK4 and his rig should be ready anyday now and then we will be running a sked also. VK3GG QSO here on 28 Mc. favours around midday times and I have arranged to QSO on 28 Mc. at 1045 EST each Sunday then 3GG transmits on 50 Mc. 11 to 1130, 5KL transmits 1130 to 1200, then if nil report back on 28 Mc. Here on 28 Mc. most evenings VK3 rise to R9 and I feel that something may occur, during those times. All interested in skeds, etc., please QSO me on 28 Mc. or write to me: VK5KL, C. N. Castle, c/o. Dept. Civil Aviation, Darwin.

"ZL1HY has sent to 'Break In' that I will be on between midday and 1 p.m. N.Z. time and as this is about same time as skeds with VK3 and in same direction here's hoping something will happen this summer. When 50 Mc. opens I'll be in booting so 73 for now and see you on 50 Mc."

The VHF Section of the W.I.A. (S.A. Division) will soon, we hope, be an actual reality. Embryonic portions have met at a variety of places and times, a popular spot being ye windmill in Prospect, each Saturday at 5 p.m. 5RT and 5QR claim to be foundation members there, but 5GB, 5JD, 5RQ and 5KC have been welcomed. Much animated discussion takes place in spite of a variety of QRM and the QTR bug.

50 Mc. has temporarily (we hope) suffered a total eclipse in VK5. Historians of the section tell us that 5BQ was the last of the original tribe, and after talking to himself for some weeks, finally ordered a new logbook printed for 14 Mc!

The Hams "talking" 50 Mc. are many, and with recent developments in the Eastern States, indications are that at least some of the gang in VK5 will use adequate equipment, in the form of beams, superhets, and QRO C.C. rigs, in an endeavour to contact the other States.

Most activity occurs on 166-179 Mc. where cross town rag chews are fairly common. 5RQ and 5KC can be

heard by the half day, testing and talking!! 5RT and 5QR are regularly engaged each Sunday night in their weekly chess struggle.

5GB can use either C.C. or a self excited type 210 on 50 Mc. A pair of 7193s in P.P. using a variety of antennas including one leg of zepp feeders, takes care of 166 Mc. transmissions. Rx usual superregen. and audio. Some of George's "tests" have the gang worried at times. 5RQ—Using a single 7193 with coil and condenser tank on 166 Mc. With single wire antenna, Claude puts out FB signals. Rx is 955-6F6. An RF stage for the Rx is on the New Year building programme! At present no 50 Mc. equipment. 5KZ—Partner in crime to 5RQ. Using two transmitters on 166 Mc. 6J6 with plate lines, and a semi-portable rig using 7193 coil and condenser tank osc., modulated by single 6V6. Antennas are a folded dipole and a double extended zepp. Open wire feed lines are used. The Rx is usual superregen and audio. Also planning an RF stage. 5KC—Has not been active on 166 Mc. for some time. Has a 4 stage C.C. portable on 50 Mc. and the 166 Mc. transmitter is an RK34 with plate lines. Rx is 2 tube superregen, 9002 as osc. Ken is QRL, study and rebuilding. 5JD—Is making valiant efforts to establish reliable contacts across the city. His next effort will include a rotary beam and a 50 ft. dipole. Equipment: 7193 on 166 Mc. and usual superregen. Rx. 5GF—Active on 166 Mc. and 50 Mc. and is using a transceiver with 7193. Puts out a very well-modulated signal. Intends to use a 50 Mc. rig in a trip across the Gulf during Xmas vacation. 5JU, 5BQ, 5CR, 5MD, 5HN, and 5GM have been heard on 50 Mc. many moons ago. 5RT can use C.C. on 50 Mc., using RK20 as a doubler. Pair 7193s with plate and filament lines, and open wire fed double extended zepp on 166 Mc. Rx is 7193 and audio. 5QR—807-807-832 C.C. on 50 Mc. or uses 813 as doubler. RK34 with plate lines

## FEDERAL HEADQUARTERS.

Federal Executive wish to extend to all Divisions and members, greetings for the New Year of 1947 and to thank them for their help and support during the momentous year of 1946. Federal Executive for its part, will continue to apply itself to the task of improving the operating facilities of amateurs and furthering the affairs of the Wireless Institute of Australia as the meeting place of the Australian Amateur.

In spite of some criticism, which has come from various uninformed quarters, much has been achieved in 1946 for the re-establishment of the amateur way. Many frequencies have been allocated for amateur use, operating facilities have been extended, some of which did not exist before the war. The P.M.G. Department in Melbourne has shown itself to be most friendly and helpful towards the Australian Amateur, and Federal Executive attribute this to the cordial feeling which has continued between the Institute and the Department over many years.

Much work was done in holding a DX conest, in preparing a constitution for the Federal body of the Institute (which is not yet completed), in re-starting the QSL Bureau, and many other duties.

The Federal Executive will exert itself in this new year, towards the completion of the work it set out to do, in obtaining all facilities possible for the amateur and co-ordinating the domestic affairs of the Wireless Institute.

running 16 watts on 166 Mc. Antennas are open wire fed folded dipole, and co-axial fed J. Rx is 955 osc. 6V6 audio. Seriously thinking of QRO on 50 Mc. complete with beam and superhet.

# Congratulations!

To the boys who broke through on 6 metres. More DX to them. We expect the EDDYSTONE components to break through to the Australian market about mid January. They are worth waiting for. Remember the Distributors:—

J. H. Mcgrath and Co.,  
Melbourne.

Chandlers Pty. Ltd.,  
Brisbane.

John Martin Pty. Ltd.,  
Sydney.

Carlyle and Co.,  
Perth.

Gerard and Goodman Ltd.,  
Adelaide.

W. & G. Genders Pty. Ltd.,  
Launceston & Hobart.

Australian factory representatives:—

## KEITH HARRIS & CO. PTY. LTD.

(Inc. in N.S.W.)

51 WILLIAM STREET, MELBOURNE.

Phone: M 1110 (2 lines).

R. H. Cunningham, (VK3ML), Manager.

## DIVISIONAL NOTES

### NEW SOUTH WALES

Secretary: Peter H. Adams, VK2JX,  
Box 1734 G.P.O. Sydney.

Meeting Place: Science House, Gloucester and Essex  
Streets.

Meeting Night: Fourth Friday of each month.

#### NEWCASTLE ZONE

2FP has been doing consistently good work on 28 Mc. since erecting a new 48 feet tower for the three element rotary. With four tons of concrete in the base the tower is a very solid job. A platform at the top allows him to make any adjustments. — — — Dave of 2BZ was in hospital but is OK now. Before his illness he poked some 50 Mc. signals down to 2OC at Wyong. The local gang are glad to know you are well again; it was noted however that some of the locals have been able to work lots of DX during your absence. — — — 2ZC is testing and not so active after putting up a good score during the VK DX test. — — — 2AHA also taking things easy since the contest but has been heard on 14 Mc. fone. — — — 2AGD, George, rebuilding and not on often. — — — 2CS still building and was advised by one of the senior service boys to put away the pencil and get out the soldering iron. — — — 2AMM very active on 7 Mc. fone—good work too. — — — 2XQ inactive except to eliminate the haywire from the tx. — — — We should be welcoming some new Hams into the Zone, at least three have received tickets.

### SOUTHERN ZONE

It is a pleasure to take up the pen and once again write some notes for this Zone. I would like to take the opportunity of asking for the co-operation of the gang down our way, whom I have not contacted by sending along dope on his rig and activities for inclusion in this column. Send it along early each month so we will have the latest.

2GG has been working on 14 Mc. 6V6 and 807; antenna end fed. Jim's main interest at the moment is building a caravan for Xmas vacation. Guess the rig will be included. — — — 2QD now located at Wymah, Upper Murray. Uses a No. 11 set on 7 Mc.—main problem a heavy chirp. Hilton has plenty of room for a good antenna now. — — — 2EU has been heard on 7 Mc. fone with good quality. Antenna is low and temporary. — — — 2OJ very QRL, not very active, and a wooden tower for the rotary is under way. Rig is 6L6 tritet, 802, 801, 100TH and class B modulators. — — — 2APW will be heard on 7 Mc. soon. 6L6 tritet and 807 and a nice power pack with a receiver under way completes the gear.

#### BLUE MOUNTAINS

2LZ reached the zenith when he contacted Interstate stations in the recent band opening on 50 Mc. Con has bad power leak and loses lots of contacts through it. — — — 2AFO quite active on 50 Mc. and 166 Mc., works back to Sydney quite a lot. — — — 2HZ does the Sunday 2WI broadcast—gets out sometimes.

### VICTORIA

Secretary: R. A. C. Anderson, VK3WY,

Box 2611 W, G.P.O., Melbourne.

Meeting Night: First Wednesday of each Month.

Meeting Place: Melbourne Technical School.

#### CONDITIONS GOVERNING LOAN OF TEXT BOOKS, TECHNICAL PUBLICATIONS AND INSTRUMENTS

The Technical Advisory Committee of the Victorian Division administers both Textbook and Instrument Libraries. Every effort is being made to bring both very much up to date, and the T.A.C. proposes to publish for the information of members a list of the contents of each library, in the meantime we feel that it is quite possible many new members do not realise that such libraries even exist, or know the conditions governing loans, for their information the conditions are published hereunder.

#### TEXT BOOK & TECHNICAL PUBLICATION LIBRARY

- 1—Service Available To.—All Financial Members who accept the conditions.
- 2—Period of Loan.—One month or part thereof. Borrower may be granted an extension of time at the discretion of the Librarian.
- 3—Penalty for Detention.—Names of members who consistently offend by retaining books, etc., beyond the prescribed period are liable to be removed from list of eligible borrowers.
- 4—Responsibility for Damage.—Borrower is responsible for returning books in good order and condition, and should insist on librarian recording, on index card, any blemishes before accepting loan, otherwise member concerned shall be called upon to compensate library.
- 5—Recording Action by Librarian.—When book, etc., is issued or returned the following action shall be taken by librarian:—
  - (a) Stamp date on fly-leaf of book;

## THE NEW MINIATURE 7 - PIN SOCKETS FOR BUTTON BASE TUBES

AVAILABLE IN

**BLACK HIGH-DIELECTRIC MOULDED AND  
LOW LOSS MICA-FILLED MOULDED  
BAKELITE**

Mica-filled . . . 1/6 retail 18/- doz.

Black . . . . . 1/1 retail 13/- doz.

**33 1/3% discount to Amateurs**

**Prices subject to 10% sales tax.**

## AUSTRYL RADIO SUPPLIES

T. D. HOGAN (VK3HX)

127 Oakleigh Road, CARNEGIE, S.E.9

Telephone: UM 1732

(b) Record date, signature of borrower and signature of librarian on index card provided.

6—Country Members.—When writing to request loan shall add registration fee. Books will be forwarded in proper mailing container and must be returned in same. Books registered on forward journey must be returned by registered post.

7—Limitation.—Only two books or four publications may be borrowed at the same time, unless librarian deems it necessary to increase number where serial type articles are involved.

**INSTRUMENT LIBRARY**

Conditions 1, 2 and 3 as for Textbooks and Technical Publications Library.

4—Categories.—

(a) Fully Restricted.—For use in laboratory only but may be used by members under supervision.

(b) Partially Restricted.—Available at member's risk after submitting deposit.

(c) Unrestricted.—Available at Institute's risk, unless it is obvious that instrument has been maltreated.

5—Tests Before Acceptance.—It is the responsibility of member to insist on instrument being tested in his or her presence before accepting loan. In the case of country members, librarian shall include certificate stating that tests have been carried out prior to despatch.

6—Recording Action by Librarian.—See 5 (b) Book Library.

7—Country Members.—Treat as registered book.

8—Limitation.—Number of instruments available to a member at the same time to be at the discretion of the librarian.

Next month we hope to present for your information a list of library contents. When in doubt about books get in touch with Jack Groves. If instruments is the subject of query Reg Jepson is the man. Somewhat irrelevant, but never-the-less important, Reg Bush (VK3LS) has been appointed organiser of Bush Fire Auxiliary with Harold Webber in charge of technical equipment. Reg can be contacted at FU 3619.

**QUEENSLAND**

Secretary: C. Marley, VK4CJ,  
Box 638 J. G.P.O., Brisbane.

Meeting Place: State Service Building, Elizabeth St., City.

Meeting Night: First Friday of each month.

At the October general meeting we were glad to welcome visitor Cliff Gold, 4CG from Toowoomba. Discussion took place on the eternal question of splitting the bands for phone and CW. Various suggestions were made as to what the sub-divisions should be, one member suggesting that in the case of 20 meters, 14000-14100 be for CW, 14100-14200 for phone, and the rest free for all. The problem is of course that it is difficult to avoid a "dead spot" caused by the American phone band, but in any case we would be pleased to hear what the views of country members are on this question.

Discussion also took place re the projected Xmas Party and it was decided to hold same on the 13th December. The function took place on Friday, 13th December, and resolved into a solid rag-chew, which finished in my case about thirty minutes past midnight. We were very pleased to have along as our guest Mr. Conry, the Chief Radio Inspector, and to judge by the lengthy chinwag

**TECHNICAL BOOK & MAGAZINE CO.**

**297-299 SWANSTON STREET, MELBOURNE**

(Opposite Old Melbourne Hospital)

Central 2041, Melbourne, C.I

We can arrange subscriptions to any of the following magazines:

**AMERICAN.**

RADIO: . . . . .	25/- year	COMMUNICATIONS: . . . . .	24/- year
Q.S.T.: . . . . .	20/- "	RADIO NEWS: . . . . .	32/- "
C.Q.: . . . . .	20/- "	RADIO CRAFT: . . . . .	22/- "
SERVICE: . . . . .	24/- "	SCIENCE DIGEST: . . . . .	23/6 "
F.M. & TELEVISION: . . . . .	48/- "	PROCEEDINGS INST. OF RADIO	
ELECTRONICS: . . . . .	97/6 "	ENGINEERS . . . . .	88/- "
SPECIAL RATE FOR THREE YEARS: . . . . .	195/- "	POPULAR SCIENCE: . . . . .	23/6 "
		POPULAR MECHANICS: . . . . .	23/6 "

**ENGLISH AND AUSTRALIAN.**

WIRELESS WORLD: . . . . .	25/- year	WIRELESS ENGINEER: . . . . .	42/- year
PRACTICAL WIRELESS: . . . . .	13/6 "	ELECTRONIC ENGINEERING: . . . . .	33/- "
AUST. RADIO WORLD: . . . . .	10/6 "	RADIO AND HOBBIES: . . . . .	6/6 "
AMATEUR RADIO: . . . . .	6/- "	SHORTWAVE MAGAZINE (English): . . . . .	25/6 "

Just published by P.M.G.'s Dept.

**LIST OF EXPERIMENTAL STATIONS IN AUSTRALIA.**

2/-d. each; Postage 2½d.

**FOREMOST IN AUSTRALIA FOR TECHNICAL BOOKS.**



# LOW DRIFT CRYSTALS FOR AMATEUR BANDS

ACCURACY 0.02% of STATED FREQUENCY  
3.5 M/C and 7 M/C.

Unmounted . . . . . £2 0 0  
Mounted . . . . . £2 10 0

12.5 and 14 M/C FUNDAMENTAL CRYSTALS—LOW DRIFT—MOUNTED ONLY . . . . . £5 0 0

SPOT FREQUENCY CRYSTALS—PRICES ON APPLICATION.

REGRINDS . . . . . £1 0 0

THESE PRICES DO NOT INCLUDE SALES TAX.

**MAXWELL HOWDEN, VK3BQ**  
15 CLAREMONT CRES., CANTERBURY, E.7

between 4FB and that gentleman we think that Fred must have been requesting a band for his own personal use. Some twenty six members did full justice to the refreshments provided, particularly those of the liquid variety.

Frank Shannon passed along some dope from country members regarding the kind of notes they would like to see in "A.R." Firstly, we don't think that the practice of recording the names of members attending general meetings in "A.R." would serve any useful purpose. The space in "A.R." could be used to better advantage I am sure, and in any case it has always been the practice to record any visitors who might drop in. The list of attendance would otherwise be a constant repetition of the names of about twenty regulars. We did decide however that it would be a good idea to provide an attendance book so that those members present can record their signatures for posterity. Regarding station descriptions, the opinion has been expressed that they hark back to a decade or so ago, but if some want them we can feature a few, so if country members want to be "featured," it's up to them to furnish the dope.

The lecture which was to have been given by VK4FN had to be held over owing to the absence of that gentleman. Congratulations are due this month to VK4s JP and HU. George has acquired a junior op., while George (HU) has acquired twin girls. HU evidently believes in push-pull operation, whilst JP favours the single ended technique. Congrat., OMs.

It was decided to form a VHF Section of the Institute, particularly since interest in country men appears to be on the increase. 4ZU was appointed to organise same, and look after the VHF end of the business generally. We are glad to see healthy signs of interest in the Ipswich gang and hope soon to see 'em on 50 Mc.

In view of more recent happenings, or should one say "Phenomena," it seems a trifle absurd to go into any great detail about the "Field Day" held by the Queensland VHF gang on Sunday, 16th November. However to keep things in their proper perspective a description is essential, so here goes.

Although I have credited the local gang with credit for the event it should really go to 4XG, who on the day mentioned, sallied forth with his 50 Mc. gear and set up shop on the Maleny Range about 60 odd miles from Brisbane. 4ZU was listening at Cape Moreton, 30 miles from Maleny, and about 40 from Brisbane, while the rest of the boys were on the job in Brisbane. Gordon 4XG succeeded in putting an S9 signal into Brisbane, as did most of the locals into Maleny. 4RY, 4AW, 4HR and 4FB were the Brisbane stations involved and it was generally regretted that the test had not been over a greater distance. 4XG's signal was heard at S9 at Cape Moreton by 4ZU, but the locals only managed to put comparatively weak signals over the hills, etc. in the intervening distance, showing that the line of sight from Cape Moreton helped materially.

As everybody knows by now, line of sight went by the well known plank on Saturday, 30th November, when 4ZU's 50 Mc. signal was heard by 3HK and 3PK. After the incredible information had been passed on to 4ZU by 4FE via 3YS (thanks OMs) skeds were arranged for that afternoon (1st Dec.), but nothing transpired. On Thursday, 5th December, 4HR achieved the great honour of being the first VK4 to work DX, namely VK3. As Tibby is probably Queensland's outstanding DX man (93 countries since the war) he should be very well pleased. Our congrats. Tibby.

Like wolves in for the kill, 4AW, 4RY, 4FB, 4XG and 4ZU swooped on to the band and proceeded to lap up the DX so fruitfully abundant. Amongst the VK3s work-

## Australia's Largest Stock OF ALL RADIO COMPONENTS

- |                           |                    |
|---------------------------|--------------------|
| Chokes                    | Resistors          |
| Coils                     | Soldering Irons    |
| Condensers                | Speakers           |
| Dials                     | Test Equipment     |
| Intermediate Transformers | Valves             |
| Morse Equipment           | Pick-Ups           |
| Potentiometers            | Power Transformers |
| etc. etc.                 | etc. etc.          |

*Obtainable from*

### BLOCH & GERBER LTD.

*with which is associated the*

### WELDON ELECTRIC SUPPLY CO.

46-48 YORK STREET SYDNEY

G.P.O. Box 2282 M.

Phones: MA 6291 (10 lines)

# A.G. HEALING

LIMITED

MANUFACTURERS AND  
DISTRIBUTORS FOR . . . . .

Electrical and Testing Instruments for all purposes made to British Standard specifications. Each instrument is accurate, + or - , to 2 per cent., and parts are heavily plated to prevent corrosion even under tropical conditions. "Healing" Electrical Meters equal the best imported types and will give accurate service for long periods under the most exacting conditions.

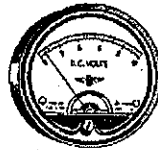

No. 10A round production mounting Black Bakelite Case.

Type No. 30A 4" square semi-flush Black Bakelite Case.

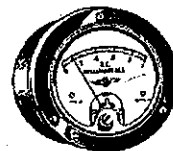
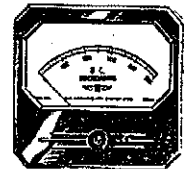

No. 20A 2½" round flush mounting Black Bakelite Case.

These, and all other Healing Radio Electrical Testing Units, are manufactured in our own factories and available from A. G. Healing Ltd.

**OTHER INSTRUMENTS INCLUDE:**

Oscillators — Multi-Testers — Signal Tracers, etc.



**ALSO MANUFACTURERS AND DISTRIBUTORS FOR**

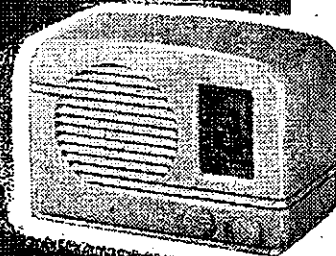

## Golden Voice RADIO

A. G. HEALING LTD., MELBOURNE, SYDNEY, ADELAIDE

ed were 3NW, 3HK, 3GG, 3MJ and probably others. It was a hectic night and one that will live long in the memory of those few kindred spirits who inhabit 50 Mc.

Then on Saturday, 7th December, 4AW, long a keen exponent of the higher frequencies, reaped the reward of his labours, being the first VK4 to QSO VK2. The VK2 in question was Don, 2NO, so the event was surely a pleasant one. 4FB and 4ZU heard 2NO but no contact was made, although 4AW, to do the job properly also worked 2WJ and 2AZ. The VK3s started to roll in by this time and the gang did full justice to them. 4FB's performance in all this activity was greatly hampered by his receiver being a superregen. (2 tubes), and it did not appreciate the QRM from the locals. A Converter has since been completed however so Fred should have no further trouble from this score.

Again on the 9th December, the band again opened up and 4AW and 4ZU had several QSOs with VK2, namely 2NO, 2ABC, 2WJ and 2AZ, although 2NO once again eluded 4ZU. 2JU was also heard by 4AW and vice-versa, but a QSO did not really take place. The VK3s were also coming in during these interesting proceedings and in my opinion this was their best night yet, as far as reception here was concerned. 3MJ, 3HK, 3KK, 3YJ, 3LS and 3NW were heard and mostly worked here at 4ZU, and 4AW earlier had his hand in the pie. 4XG and 4FB were a little unfortunate in that they left it a little late in adjourning to their shacks. 4AP who had made his debut on the band on the previous day, also had some of the DX come his way, and 4HR on holidays at Caloundra, 60 miles North of Brisbane, succeeded in working 3HK on his portable.

That apparently is the finale for the time being, but, it's happened once, it can happen again. The propagation people here in Brisbane could throw no light on the mystery (how we've always had a weakness for mystery!) and Mt. Stromol were of little more help, the only advice being that the M.U.F. for the occasion was about 10 Mc. which shows that those signals must have had quite a "walk-about" before finally hitting Brisbane. Likewise the reason for VK2s and VK3s being heard together is rather intriguing.

## SOUTH AUSTRALIA

Secretary: E. A. Barbier, VK5MD,  
Box 1234 K, G.P.O., Adelaide.

Meeting Place: 17 Waymouth Street, Adelaide.

Meeting Night: Second Tuesday of each month.

The W.I.A. and I.R.E. in VK5 combined to hold their Xmas Social in the Arcadia Cafe on Tuesday, 10th December, at 8 p.m. The guests of honour included Mr. H. R. Pinkerton (Radio Federation of S.A.), Messrs. J. de Cure, P. Traynor, C. Pike, L. Thomson and McGee (P.M.G. Radio-Inspectors), F. W. Tideman (Electricity Trust of S.A.), George Barber (Chief Engineer 5DN), and Colin Howie (Chief Engineer 5KA). Professor Kerr Grant was the guest speaker and his interesting and informative talk "Rays" was thoroughly enjoyed by a gathering of over 150 members of both organisations. Mr. Don Gooding (Chief Engineer 5AD and Chairman of the I.R.E.) proposed the toast of "The Founders of Radio" in which he quickly sketched the growth of Radio from early days until the present era. One particular point stressed by Mr. Gooding was that radio men, both amateur and professional, had always endeavoured to pass on any information or knowledge for the benefit of the coming generation. In stressing this point Mr. Gooding unconsciously was expressing one of the strong points in the amateurs' code and whilst Mr. Gooding was primarily an I.R.E. speechmaker, he thus was giving the W.I.A. the vote. Mr. R. Brisbane stepped into the breach and on behalf of the I.R.E. welcomed the members of the W.I.A. This left the W.I.A. two up and when Mr. I. Thomas (5IT) returned thanks to the I.R.E. on behalf

VK3NU

## Major Radio & Electrical Co.

189 Glenferrie Road, MALVERN, Vic.

U 9354

WM 1814

### MULTI-MATCH MODULATION TRANSFORMERS.

75 Watt Multi-match Modulation Trans-  
formers wound with highest grade  
materials . . . . . £4 10 0  
Line-to-grid Transformers . . . . . from 19 6

All types of Power Transformers made to order.  
Write for prices.

### STEEL CHASSIS — PANELS — RACKS

Steel Chassis—Any Gauge—Any Size—Any Finish.  
Prompt Delivery. Send specifications and a price will  
be forwarded by return mail.

### ACORN AND TRANSMITTING VALVES—SOCKETS.

Immediate delivery: Post Free, any State  
All types: 807, 809, 866A, 83, VR105, VR150  
available. 954, 955, etc.  
5-Pin and Octal Seatite ceramic sockets 2/9 each  
Ceramic Acorn Sockets . . . . . 3/9 each  
Wafer type EF50 Sockets . . . . . 9d. each

of the W.I.A. we were in an unbeaten position. Mr. "Doc" Barbier (5MD) deciding to clinch the victory, delivered telling blows when he welcomed the visitors. He led a somewhat doubtful punch when he included the I.R.E. members as visitors, but as the I.R.E. were now out on their feet nothing really mattered. Mr. F. W. Tideman responding on behalf of the visitors plugged one for us when he said that but for fate he might have been an amateur sitting at the ordinary tables and knowing a lot about radio, instead of knowing nothing and being at the guest table. Mr. W. Bland (vice-chairman of the I.R.E.), speaking on a vote of thanks to the guest speaker, was all set to stage a grand recovery for the I.R.E. but we brought on the "eats" at the psychological moment, and the I.R.E. threw in the towel. Altogether a well organised and decisive victory in favour of the W.I.A.

Joking aside the gathering was a huge success and reflected great credit on those responsible for the organ-

FOR SALE

## COMPLETE CW STATIONS

Brand New, CC Xmitter, 30 Watts, operates on 80, 40 and 20 Mx. with Receiver, Phones, Key, Power Supply for AC or 6 Volt Battery, Coils and all spares. For Home or portable use. Less only Xtal . . . . . £30.

420 WILLIAM STREET, MELBOURNE

Phone: FJ 1339

# GLO-RAD

## RECOMMENDS . . . . .

Use of "Clipper" circuits as means of securing greatest results with least waste of modulating energy.

Limited number of suitable Input, Interstage, and Output Transformers are offered to Hams.

**PRICE 20/- plus Sales Tax.**

Please add postage and exchange to country orders.

**Mail your order NOW . . . .**

## Glo-Rad Engineering Services

Box 2147T G.P.O., Melbourne

Phone: WX 3440

ising, and is something that can stand repeating. Mr. Cyril Talbot, ventriloquist and entertainer, enlivened the proceedings and aside from one or two decidedly "blue" jokes (which by the way seemed to amuse both I.R.E. and W.I.A. members in equal amounts), his act was "tops." With the hour growing late everybody voted the social as being 100 per cent. and a general exodus took place. When I left, the W.I.A. contingent were holding an unofficial meeting on the footpath of King William Street, and for all I know it is still going on.

5FQ is in the process of rebuilding and the air seems quite empty without him. He is almost as consistent as 5JS, almost! 5GM is putting a good signal out on 14 Mc. mostly working VK2 sigs, how's DX Ron? An indication as to how the various frequencies have been in VK5 may be had from the fact that 5JS has been inaudible for quite long periods at times and that's saying something! 5GP has been heard with a good signal working on 14 Mc. with 5RL. Both being ex-merchant radio officers gives them a lot in common. 5JU heard on 14 Mc. quite often lately but sounds like DX to me; how are you seeing them "Huck?" 5KC was heard making enquiries concerning the installation of a telephone at his QRA; needless to say nothing doing.

5KG has a habit of going W.A.C. on Sundays on 28 Mc. and usually times it around 10 hours or so; what about W.B.E. Bert. 5IT unobtrusively slipped a W.A.C. in on a Sunday when all good Hams were at Church, Sunday School or something; mostly something! 5LO has been active on 14 Mc. judging by the number of stations calling him, but so far I have not heard him. 5RR heard on 7 Mc. with the Institute news every Sunday at 10 a.m., and is doing a real good job. This type of broadcast could easily be put over in the wrong way, but Reg is doing a 100 per cent. job and will welcome any news or dope you may care to send him. 5SF has a vertical mast that is the envy of all and sundry, but can't say if it is radiating as yet. 5TV has been heard on CW and

phone on 14 Mc.; an ex-VK3 at present domiciled at Henley Beach, he votes VK5 a good spot; of course all the best Hams live at Henley Beach; naughty! naughty! 5WK consistent on 28 Mc., seems to be working all the available DX and I have it on good authority that his voice on the air is in the "Swoonatra" class; atfoboy Nobby! Heard 5BQ calling CQ one Sunday afternoon accompanied "Forte" by his young hopeful; BQ led by a short head until just approaching the close of the CQ, when he broke down completely and left the lead in the undisputed lungs of "it;" is "it" a boy or girl OM? 5BC has been on annual holidays and regaled us with tales of DX heard up at Springcart Gully on the Murray where he is resident in charge of the local BC station; if all he says is true, about DX, it is a wonder the locals ever get any programmes.

One of the highlights of the recent visit to the radio section at the School of Mines was 5DC calling CQ DX on a small transmitter whilst a gang were tuning a receiver on the other side of the partition trying to pick up his elusive DX station; believe it or not 5JS was heard on the same receiver. Me thinks I heard 5HN working with 5RR the other Sunday on 7 Mc.; strangely enough he was fading to me and I was not sure. At time of writing Mayo Richards, 5WR, is an inmate of Flinders Ward in the Royal Adelaide Hospital; trust all is well now Mayo. Heard 5JT working traffic early one morning last week; there's no doubt about Joe, he has the traffic handling game down to a fine art. Was making a rough check the other day as to the number of Hams whose vocation is broadcasting in VK5; almost without exception all the technical staffs are Hams from the Chief Engineers down to the relay boys (pardon me Wykeham) and to think that these Hams work at it all day and then go home and play at it best part of the night; this amateur radio must have something. Some weird and wonderful substitutes for frequency meters were trotted out during the recent inspection of Ham shacks by the R.I. in VK5. The looks of injured innocence on some of the Hams when the obvious disadvantages of these frequency meters were pointed out would have melted even the stoniest hearted R.I.

## TASMANIA

Secretary: J. Brown, VK7BJ,

12 Thirza Street, New Town. Phone W 1328.

Meeting place, Photographic Society's Rooms,  
162 Liverpool Street, Hobart.

Meeting Night: First Wednesday of each month.

Council meeting for November was held at residence of 7PA, 12 Amy Street, Moonah, on the evening of the 22nd. Present were 7LJ, 7BJ, 7CJ, 7CT, 7RF and 7PA. Apology from 7CW. Minutes of previous meeting read and confirmed. Correspondence read and confirmed. Five membership proposals were received and passed on for confirmation at the next general meeting. Much adverse criticism was levelled at the time at which the recent contest ended, 3 a.m. was considered as out of the question for men who had to go to work the same morning. The inter-divisional discussion of divisional matters of a general nature was favourably commented upon, it being contended that this helps to air matters liable to affect our organisation generally. After some general chatter the meeting dispersed.

The general meeting was held as usual on 4/12/46, those present being 7LJ in chair, 7BJ, 7CJ, 7ML, 7DH, 7DW, 7YY, 7CT, 7CW, 7GR, 7OM, 7LL, 7AL. Messrs. Fulton and friend, Koglin, Nichols, L. Durkin, R. Harris, N. Lipscombe. Apologies from 7XA, 7AH and 7PA. Minutes of previous meeting were read and confirmed. Correspondence inward.—F.H.Q. re regulations, etc., circular from VK6. Outward to F.H.Q. re first draft of revised constitution. New members P. Wetherell (7PW Launce-

# QUIET

PERMANENTLY

*Silent Spiral  
Connector...*



NO SLIDE  
NO FRICTION  
NO NOISE

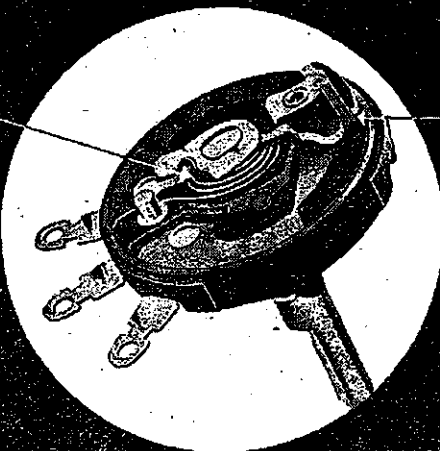

*5-Finger  
"Knee Action"  
Contact*



AMAZINGLY  
SMOOTH...  
PERMANENTLY  
QUIET

# IRC VOLUME CONTROLS

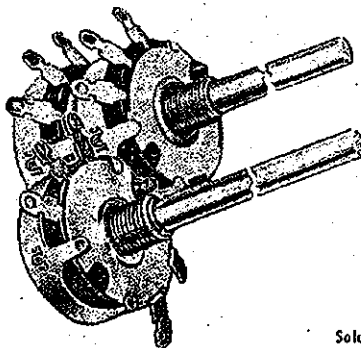

IRC HAS SPARED NO EXPENSE SO THAT  
YOU CAN BE SURE

Study the design of IRC Metallized Controls. Note in particular the precision construction of the 5-finger "Knee Action" Silent Element Contact and the new Silent Spiral Connector.

Each of these exclusive features means thousands of pounds in research by IRC engineers. Each means additional manufacturing expense—yet IRC Controls cost you no more than ordinary controls having neither of these noise-eliminating features.

It is "plus" values such as these that have made IRC resistance products famous the world over. By giving you the greatest value for your money, by doubly insuring you against customer complaints, we protect our reputation by helping you protect yours. That is good business for both of us.

Sole Agents for Australia:

**Wm. J. McLELLAN & CO.**

BRADBURY HOUSE, 55 YORK ST. SYDNEY • PHONE BW2385

## MAGAZINE CHANGE

Beginning with the March issue of "Amateur Radio" some changes will be made in the layout of the magazine. Instead of a page having two columns it will in future have three. From that date the deadline for copy of notes, etc., for inclusion in the following month's magazine will be moved forward to the 15th of the month. Copy arriving after that date will not be considered. It is only by taking this step that makes it possible for production of the magazine by the 1st of each month.

## VE8MJ

This station is located at a Hudson Bay Post on Baffin Island and enjoys one delivery and collection of mail per year. He has been using a 6L7 oscillator to drive a single 6L6. The aerial was a half wave centre fed, and the power supply consists of a vibrator giving 300 volts at 100 Ma. The annual supply ship has delivered some new gear and should be now better equipped.

## ENGLISH AMATEURS

As from November 6, 1946, English Amateurs were authorised to use the remainder of the 7 Mc. and 14 Mc. bands. The W/T Board had informed the RSGB that they were prepared to release these frequencies as early as the 1st of November, but other Governments had not signified their agreement. On November 1st the U.S. Government through the F.C.C. issued an order authorising the release of the remainder of these bands.

It would seem that the U.S. Government, after rejecting the W/T Board suggestion, and thereby causing other administrations to follow suit, suddenly changed its mind without notifying other Governments.

## W.I.A. BROADCASTS

VK3WI appeared on the 7 Mc. band on Sunday, 5th January, with the first official bi-weekly broadcast of news of interest to the Institute member and also to Hams generally. It is the intention to give these broadcasts twice a week, on Sunday morning at 1130 hours EST and to repeat the broadcast on Tuesday night at 2030 hours EST. The frequency for the present is 7180 Kc.

It is known that VK2WI has in the past broadcast at 1100 hours and will continue to do so. The Editor is unaware of a definite fixed frequency.

The South Australian Division has commenced a regular broadcast which originates from VK5RR on the 7 Mc. band on Sunday mornings at 1000 hours South Australian time.

All Divisions would welcome reports, suggestions and items of news for inclusion in these broadcasts.

ton), Manning (7LR), Oliver (7JO), country members R. Harrix and Crosswell associate members were elected unanimously.

After general business concluded 7LJ took the floor (literally) with a somewhat unusual lecture subject outside the usual Ham Radio topics, but none the less interesting, that of Chromosomes and Ganes as relating to animal and plant life in general and also the human being. This lecture was done in Lon's usual thorough way, it was supported with stills on film (slides de luxe). I don't propose to enlarge on the subject here but it was well received and 7LJ got a very cordial reception for his effort. For those who don't know, 7LJ delves into photography and cinematography in his leisure moments.

The field day held on 24/11/46 was a great success and a detailed history of the day is compiled under a separate heading by 7YY who was present and gives first hand information. — . . . — Loose sand can be heavy going as 7CJ found on the field day when he struggled two 6 volt 13 plate accumulators, one in each hand, through it. Have to empty your boots Alan? — . . . — Some doubt existed as to what 7LL was going to do when he got to the water's edge on the beach in his search on field day, it was thought he wished his car was a "duck" for a start but much relief was felt when he changed his course after some meditation. — . . . — 7CW has equipment ready for 50 Mc. and reports having heard VK2 quite strongly, possibly he will have made a few contacts e'er these notes appear. — . . . — 7LJ says he contacted 7IL (King Island) recently on 7 Mc. and his signals were romping in here in V.I.H. Lon also reports traffic skeds operating FB but not a great amount of traffic to date.

VK7 membership is now past the 50 mark with 46 full members and still mounting.

### SOUTHERN VK7 FIELD DAY

Perfect weather and high spirits provided the main essentials of a good field day on Sunday 24th, when fourteen cars set off from the Customs House, armed with everything from supers to one-lungers, on the trail of 7BJ and 7CJ who, with Mrs. BJ and offspring, had taken a No. 22 set somewhere "within 15 miles radius of Hobart."

First stop for most of us was the Domain, where the big question became "which side of the Derwent, and where's his signal, anyway." Good solid broadcast harmonics, a sizzle from the tramway workshops and then a whisper from the great beyond—"Test de VK7WI"—7CT's windscreen wiper driven disc saving Joe a spot of work. The minimum was there all right—some 30 degrees of it!—sense said over the river, so a tight procession headed for the bridge, with CW out in front sporting an aircraft loop up on top of the Willys.

We rather lost sight of the field after CW shot off towards Cambridge aerodrome, followed shortly by 7AL, but after a good feed of CT's dust around back roads, a cocked hat of sorts was obtained over Seven Mile Beach, a few miles short of which we passed LJ and TR gazing through a copper-shielded loop. Once down there, we appeared to be in sole possession of a beach, an R9 signal and a nice bearing out over the ocean. Having left the Asdic gear at home, we retired up the road to beat around in someone's apple trees and had a grandstand view of them all coming in to find the transmitter a short distance up the beach.

7DH, with Mr. and Mrs. Barney Watson aboard, was first there. They brought along the station receiver, for which power was provided by a 12 volt battery driving an inverter. After a preliminary cruise around Hobart, they had made good time to 7-Mile Beach and came in on the "R" meter. 7CW, with Mesdames Walch and

## "RED LINE" AMATEUR TRANSMITTING GEAR

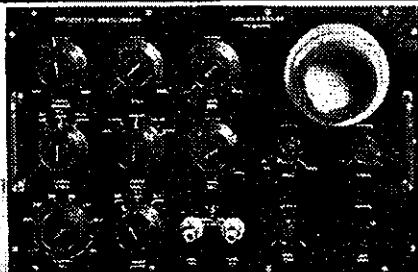

PRECISION IN DESIGN  
AND WORKMANSHIP



Technical Service,  
Wholesale and Manufacturers  
A. T. SWALES  
2 Coates Lane, Melbourne  
Cent. 4773.

Available from  
**SWALES & SWANN**  
and Leading Distributors in all States.

Trade Sales: Allen SWANN,  
157 Elizabeth Street, Melbourne.  
MU 6895 (3 lines)

Harmonic, still found time to be second after burning up the country between Cambridge and Bellerive. Crosby was getting warm at the stage where he stood up on the running board and asked someone if he'd seen a radio transmitter, but was not high enough to see it at the other chap's feet! 7BJ had thoughtfully hung up an aerial of thin enamelled wire. Then came LJ and TR, with Mrs. Jensen and family. When they found BJ's car and realised they were not home yet, TR galloped in through the bush carrying the receiver. 7AL turned up next with Mrs. Allen, small daughter and Miss Leverton, having had the back luck to cruise past earlier with his receiver on the blink. By this time, the 7CT-YY party, complete with families and local mariner Fred Saunders, ship's compass, parallel rules and the kitchen sink, had dried their boots and returned to come in fifth. Doc Kelly 7LL was then observed, with Mr. and Mrs. Lyn Brown, down at the water's edge, cooling off after their record-breaking trip up Mount Rumney. Getting on towards 1 p.m., 7GR appeared, after having investigated a "fix" at Fern Tree on the other side of Hobart (you nearly had company there, anyway, sport), and then came 7JH and 7OM with P. Hooker.

At 1 o'clock, those still out opened their envelopes and came on in. They were Charlie Oldham and J. Murray, whose miniature super was a centre of interest; N. Lipscombe, L. Durkin and R. Allanby; T. Moore, Mrs. Moore and Mr. Crosswell; R. Fulton, Mrs. Fulton, Mr. and Mrs. Millen and families, who had combined forces with 7AC; Bill Nicholas, with Mesdames Nicholas and family and Miss Finnegan.

Prizes were donated by Crosby Walch 7CW, Ray Conrad 7TR and Mr. F. W. Medhurst.

After lunch there was a get-together of distinctly pre-war flavour. Post-mortems indicated that there would be more shielded loops in evidence next time, since the trouble of threading a few turns through a length of tubing seems to be well repaid in results. The automatic call sign band on the transmitter was useful, too, but the inclusion of a good long dash in each revolution would be helpful in the early stages when signals are weak. In any case, it was an enjoyable show and indications are all for another run some time this summer.—7YY.

**D.C. FILAMENT SUPPLY.**

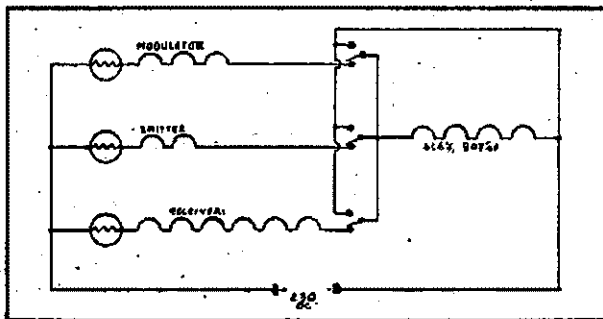
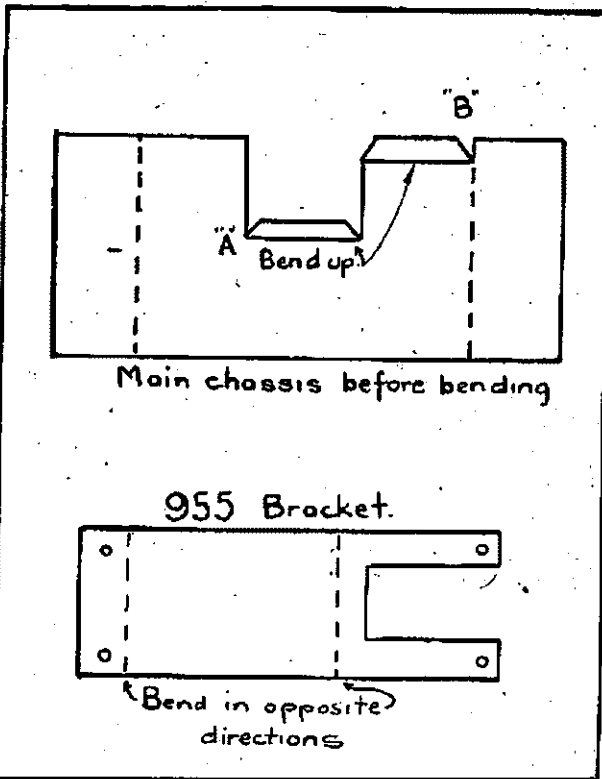

Figure 2—A Practical Example.

on, which procedure is not the best for valves having a coated cathode.

In the circuit it is assumed that all valves in the modulator, transmitter, and receiver, other than the 6L6Gs and 807s, draw .3 amp. heater current. This can fairly easily be arranged as the most common American receiving valves, other than power pentodes and rectifiers, draw .3 amp. For the oscillator in the transmitter and the output pentode in the receiver, it is suggested that valves of the 25L6 or 43 class be used. These both draw .3 amp. and fit into our arrangement very well. By use of the arrangement described above, a transmitter using push-pull 807s in the RF portion and 6L6Gs in the modulator can be used, these giving to the DC town Ham a transmitter with reasonable power, economy and using tubes of a modern variety.

**JUNKBOX TO 166.**



**FROM JUNKBOX TO 166 MEGS.**

brackets at either end. The brackets are 6 by 4 inches with a 1/2 inch flange along two edges.

Referring to the diagram, flange "A" carries the piece of two by two polystyrene which in turn supports the tuning condenser. Flange "B" serves as a guide for the perspex arm on which is mounted the antenna coil.

The tuning condenser is mounted base up, above the square hole. Having the base three inches above the chassis and four inches from the front panel permits the coil to be mounted with very short leads, well clear of any earthed object.

The 955 mounting bracket is just under three inches high. This brings the socket on level with the condenser. The plate lug of the socket is soldered directly to a stator and one end of the coil. There is thus an absolute minimum of plate lead.

The grid condenser is of the midget type, one lug being placed under a stator mounting nut and the other soldered to the grid lug of the socket.

The antenna coupling assembly consists of a metal rod with insulated bearings at front and rear of chassis. About one inch from the rear of this shaft, a 1/8-inch hole is drilled and tapped. Next a piece of perspex, 6 inches by 1/2-inch is warmed up until a half inch "foot" can be bent. Through the foot drill a hole and mount, vertically on the shaft. The antenna coil is mounted in a suitable position at the top of the perspex strip.

**TERRIFIC TWO WATTER.**

minimum of controls on the front panel. The transmitter has only one control—the final plate tank tuning. The previous stages are tuned with trimmers and are set at time of calibration. This prevents any possibility of frequency shift due to air condensers being jarred in transit. The receiver has three controls—tuning, regeneration, and AF gain. The send-receive switch is the low capacity tele-

phone type but a Yaxley type wave change switch would be quite suitable but requires more space. The final amplifier in the transmitter was found to be unstable when operated as a straight frequency amplifier on 28 Mc. so it was neutralised. When changed to 7 Mc. the neutralising set-up was left untouched although it may not be necessary on that frequency.

The antenna used in this set-up is usually a doublet because of its simplicity of feeding. A Zepp is rather impracticable due to varying feeder lengths and tuning requirements. The antenna here at Geelong consists of a doublet made from single 18 gauge power wire and "Nylex" twisted pair feed which, by the way, has quite good RF properties. The antenna is carried around with the unit and slung up wherever space permits. At the present "installation" the RF power entering the feeders is approximately 0.75 watt and signal reports from Melbourne has been up to R8 so that it is interesting indeed to see what low power will do.

The social aspect of these portable activities is very pleasing and some very good friends have been made in many country areas. In concluding let it be said to the country lads that if they see one of these vehicles in their town that there is possibly a potential source of QRM aboard from the "Terrific Two Watter."

**BROADCAST INTERFERENCE.**

the telephone department and should be referred to the Radio Inspector for further action. The remedy for this form of interference is to fit a 0.1 mfd. paper condenser across the transmitter (microphone). This should be fitted as close as possible to the unit but must be done by the P.M.C.'s. officers and must on no account be attempted by the amateur.

Details of RF Chokes in Figures 1 and 5:—  
 RFC1 = 20 turns on 1/4-inch diam. tubing (close wound).  
 RFC2 = 20-40 turns on 1/2-in. diam. tubing (close wound).

**WHAT IT IS AND WHAT IT DOES**

The comparatively new science of electronics is destined to become a powerful servant of mankind. Its applications to industry and to everyday living are almost limitless, and it may safely be said that the marvels it accomplishes today will seem utterly commonplace tomorrow.

Our purpose here is to strip electronics of some of its mystery—to explain what it is and what it does; in short, to show its relation to your personal life and the influence it will have on future living conditions.

**SOUND REPRODUCTION**

The range from below 60 up to 16,000 cycles per second in the electromagnetic "spectrum" covers the field of audible sound reproduction. A microphone picks up your voice and converts it into small electron currents, which are amplified by electronic tubes. These tubes are small power houses filled with electrons "raring to go," and only a small electric variation on their control grid is needed to produce amplified power instantly. Compare this action to the foot pressure on the accelerator of a car and its result.

Amplified speech can be carved mechanically on a wax plate or, by electromagnetic induction, "frozen" into the atoms of a steel wire. These are the principles of the phonograph and magnetic wire recording. To reproduce the sound on your record, made from the wax master plate, you use a pick-up which changes mechanical movement into electrical currents. To reproduce the sounds of a wire recorder, the magnetised steel wire runs through a coil and induces electrical current therein.

In talkies the sound that goes with the action is recorded by a photographic method in which amplified sounds activate a shutter which intercepts a beam of light. These light variations are photographed on the sound track of the film. To re-convert them into electric currents, a photo-electric cell tube is used. This tube converts light into electricity; more current for more light and less current for less light. It will convert into electric currents the whispered words of many a film love-scene or the roar of a train, to be heard through the loudspeakers of your local movie theatre. The performance is enhanced by a mercury vapour lamp, designed by the Philips organisation, that equals the surface brightness of the sun!

In a modern Brisbane hotel there is a photocell device that closes the door of the lift behind you. Without knowing it you intercept a beam of light which "triggers" the mechanism. And it's a safe bet that many of the packages on your grocer's shelves were counted and inspected with the aid of a photocell.

**SUPERSONICS**

You might not suspect that homogenised and pasteurised milk come in close contact with another off-shoot of electronics, namely supersonics. That is what sound vibrations are called when they go beyond human hearing, i.e., higher than 16,000 cycles per second. Supersonics are actually sound waves that may be generated by electronic vibrations in a sound-producing device similar to a loudspeaker. They go as high as 500,000 cycles per second, killing bacteria by their violent vibration. Thus, they are used to pasteurise milk. The milk retains more of its original qualities than when pasteurised by heat.

Certain toilet lotions and similar emulsions do not have to be shaken before using because supersonics did it for keeps during manufacture and far better than you ever could. Many a chemical process is accelerated; sulfá drugs made more effective, shell casings inspected, and ships guided into harbours by supersonics. Destructive

**BRIGHT STAR RADIO**

**VK 3UH**

**1839 LOWER MALVERN ROAD  
 GLEN IRIS, S.E.6, VICTORIA**

Phone: UL 5510

CRYSTALS ACCURACY .02% GROUND TO  
 YOUR SPECIFIED FREQUENCY.

80 metre AT Cut . . . . .	£2 0 0
Octol Holder to suit . . . . .	12 6
40 metre BT Cut . . . . .	£2 0 0
Octol Holder to suit . . . . .	12 6
20 metre Mounted Zero Drift . . . . .	£5 0 0
Plug-in Holders (Bakelite) 7/6 and 12/6	
T.C.C. 1.5 MED Filter Condensers	
4000 volt working . . . . .	£2 5 0

Filament, Power and Modulation Transformers, manufactured reasonable prices —  
 Write for descriptive leaflet on Crystals.



beetles can be kept away from shrubbery and fruit trees, and seagulls away from drinking water in reservoirs because supersonic sound waves are very annoying to such insects and birds.

### RADIO

At higher frequencies, we find electrons move either with the help of conductors or generate waves right through space, as radio broadcasts use. Quite a number of radio stations radiate up to 50,000 watts of electrical energy—the equivalent of some 70 horsepower—on frequencies from 550,000 to well above 20 million cycles per second. The lower frequencies which you find on your radio dial are for local use, while the higher ones serve for medium distance and world-wide coverage. With the help of a photocell at the transmitter, translating light and dark into electrical impulses, and an electrically controlled "fountain pen" at the receiver, news photos are transmitted from continent to continent.

### HIGH FREQUENCY HEATING

Your canned fruit might well have come from a container soldered with "Radioheat." You can glue plywood sheets together in minutes instead of hours by applying radioheat—at a frequency of around 15 million cycles per second. The manufacture of penicillin is hastened and the flow and quality of plastics improved by radioheat. Philips developed high power electronic tubes for this special application.

### TELEVISION

Television uses the part of the frequency spectrum around 50 million cycles per second. It is just another combination of photocell action and radio technique. In the television studio a "pick-up tube" is focussed on the scene to be televised. Inside the pick-up tube are thousands of miniature photocells that capture the light reflected by the scene to be televised, and they convert this light into minute electrical currents. These currents are released, one after another, with the aid of a scanning device, instantly amplified and broadcast.

At the receiving end the scene is reconstructed by a special tube called a cathode ray tube, many of which are manufactured by Philips. In a cathode ray tube a sharp beam of electrons is shot by an electron gun at a fluorescent screen of a diameter varying from 5 to 20 inches. During television reception, auxiliary currents guide this electron beam to the correct position on the screen, which lights up only at the point where the electrons hit. In this way the scene is built up, piece by piece, in exactly the same sequence as the "scanning" is done in the pick-up tube at the studio. By presenting thirty images a second, smooth flowing movement is seen on the screen. With the use of special lenses an enlarged picture can be projected, making television as entertaining as a home movie show. Black and white television requires only one scanning for each image, but colour television needs three. The first scanning releases the red, the second the yellow, and the third the blue light components of a scene to be televised. Combination colours are then separated into their primary components; green for instance, into yellow and blue. Your impression of a green picture at the receiver is then created by flashing quickly, one after another, its yellow and blue components, coloured by a rotating colour disc placed in front of the cathode ray tube.

### OTHER APPLICATIONS

Electromagnetic radiation on very high frequency bounces back from buildings, bridges and similar structures—a sort of electronic echo. We use this electronic echo to detect planes and ships when they are still out of sight or hearing range. These same very high frequencies are used to guide commercial air traffic around the country and help pilots to land planes safely in bad weather conditions.

By using a specially developed high frequency cable, hundreds of telephone conversations can be handled at the same time, between two cities for instance, where

**A  
B  
A  
C**

**AUSTRALIA'S  
BEST  
AMPLIFIER  
COMPONENTS**

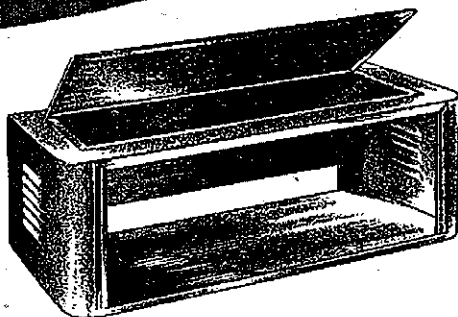

**ABAC  
Standard  
Receiver**

Or Instrument  
Case. Takes 19 x  
8½ panel with  
clear panel space  
17½ x 7½. Depth  
of case 11 inches.

MANUFACTURED BY

**TRIMAX TRANSFORMERS**

29-35 FLEMINGTON ROAD  
NTH. MELBOURNE, VIC.  
(Division of Cliff & Bunting  
Pty. Ltd)

There's 1000000000000000000 OHMS Resistance in Every Centimetre of

# "STYLON" (Etholex Polystyrene)

3500 VOLTS ARE REQUIRED TO RUPTURE  $\frac{1}{1000}$  THICK "STYLON"

MOISTURE ABSORPTION IS ZERO.

THE LOSS FACTOR IS MUCH LOWER THAN ANY OTHER KNOWN INSULATION.

AVAILABLE IN SHEETS AND RODS—CRYSTAL CLEAR OR BLACK.

**ETHOLEX PLASTICS, 108 Chapel Street, S.I., Melbourne**

WHEN PURCHASING ASK FOR A COPY OF "HOW TO MACHINE STYLON".

formerly hundreds of wires were needed. Later developments indicate that such telephone traffic can also be handled by low powered radio stations, working in relay on very high frequencies and placed approximately 35 miles apart. With higher frequencies smaller components are used. So "Walkie-Talkies" became possible. Similar developments will give you, in the future, your own "Walkie-Talkie" in your car.

#### INFRA-RED

Higher than the highest radio frequencies, but just lower than visible light, is the invisible infra-red portion of the electromagnetic spectrum. It is produced in filament type lamps that also give some visible light. You observe the infra-red radiation more as warmth than as light, because it has the pleasant characteristic of causing heat upon impact. When infra-red radiation strikes a freshly painted car, it will dry the paint from the inside out rapidly because the metal heats faster than the paint. As there is no need to heat a bulky oven, infra-red is very economical. An industrial tool of no small importance, it dehydrates, anneals and pre-heats a great variety of products at low cost and is destined for even more important uses in the future.

#### VISIBLE LIGHT

The division of the electromagnetic spectrum that follows infra-red is the radiation called light, for which you have the antennae right in your head—your eyes.

When light creates a photochemical reaction in your eyes which you experience as sight. Fluorescent lamps stand out here as major developments of the gas-filled electronic discharge tube. Their light is caused by the impact of electrical charges, increased by violent collision between electrons and gas atoms, on the fluorescent powder, covering the inside of the glass tubes. Much of the development work was done by Philips.

#### ULTRA-VIOLET

Still higher in frequency than visible light is the ultra-violet portion of the electromagnetic spectrum. A part of it is responsible for your suntan. Another makes meat tender, kills bacteria, and detects false pearls. By the name "black light"—because it is invisible—it mystifies

many a theatre audience, revealing people moving about on the stage without head or legs. This effect is obtained by treating with fluorescent materials only those parts of the costume that are to be visible.

#### X-RAYS

X-rays partly overlap and follow the ultra-violet. More dangerous to the layman than ultra-violet, they render valuable service to mankind both in therapy and diagnostics. They are electromagnetic vibrations resulting from bombardment of electrons against a metal target placed in high vacuum, and they pass easily between the atoms of matter. Depending on the density of the atomic structure of such matter, X-rays are more or less absorbed so that human tissue and bone, for instance, show up on X-ray photos or fluorescent screens as shadows of different degrees of blackness. These penetrating rays also help to inspect metals for internal flaws, align spark plugs, and detect foreign substances in foods.

A special technique uses the reflection of X-rays caused by the atoms in the crystal structure of materials. Pioneered by Philips and known as X-ray diffraction, this technique makes accurate analysis of materials faster and surer. High voltage is essential for the generation of X-rays; the higher the voltage, the higher the frequency, the more penetrating they become. With two million volts, photography through twelve inches of steel plate has been possible, revealing cracks or impurities. In this way the efficiency of many a major weapon of war and product of peace has been substantially increased.

#### PARASITICS.

That darn word is being overworked lately. It seems that in the December issue of Amateur Radio we gave the name of the author of "Selectivity", which appeared in the November issue, as A. F. Nickson VK3NB, whilst in point of fact the article in question was written by Mr. G. W. Neilson of 34 Andrew Street, Northcote. Our apologies to the gentleman concerned,—it must have been the Xmas spirit. (Tech. Ed.)

# Don't make your 'run' too late



For the  
widest possible  
Range of

# RADIO ! Parts !

And here's the 'score' or 'reason-why' from Lawrence and Hanson.

As yet, radio parts are not back in sufficient supply to meet the tremendous demands of radio enthusiasts. Consequently, it's a good idea to plan ahead—to check up now on your individual requirements and go along to one of your L. & H. retailers for everything for the

## Amateur Broadcaster.

All L. & H. components are guaranteed thoroughly efficient; reliable and made for years of quality service. And remember—if L. & H. haven't got it, it's unobtainable!

Look over this interesting list — now!

MICROPHONES  
COILS  
BATTERIES  
METERS  
SWITCHES

VALVES  
VIBRATORS  
TRANSFORMERS  
CHOKES  
CHASSES

CONDENSERS  
SPEAKERS  
RESISTORS  
LINEFILTERS  
etc., etc.

Sound Technical advice is offered and you are invited to obtain latest lists and prices from your radio house. Yes, there's a range available to meet every possible need of the amateur broadcaster from L. & H. retailers.

Be one of the first to get fully-equipped on the air!

# LAWRENCE & HANSON ELECTRICAL PTY. LTD.

33 YORK STREET, SYDNEY.  
87 ELIZABETH STREET, BRISBANE.  
120 COLLINS STREET, HOBART.

172 WILLIAM STREET, MELBOURNE.  
60 WAYMOUTH STREET, ADELAIDE.  
20 PATERSON STREET, LAUNCESTON.

# Next Aegis Success,

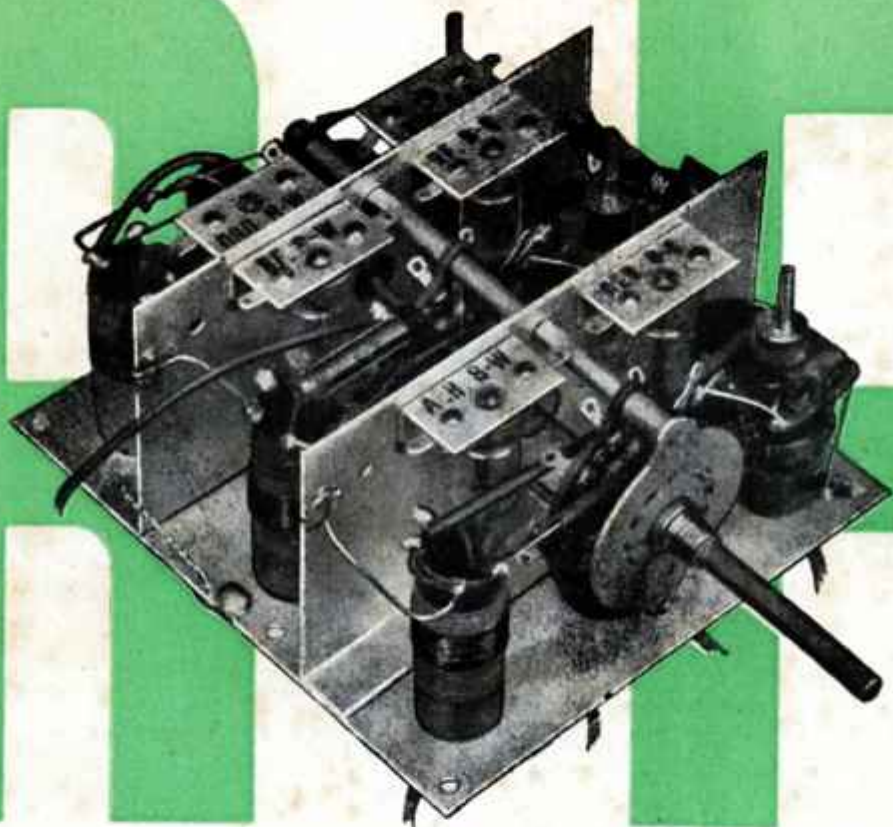

ATTRACTIVE DISCOUNT TO  
LICENSED AMATEURS FROM  
AEGIS DISTRIBUTORS IN  
ALL STATES.

## KIT

# AEGIS

MANUFACTURING COMPANY PTY. LTD.

NOW AVAILABLE! This outstanding addition to the well-known Aegis range—a three stage RF Duel Wave Assembly. Look at these features—Permeability Iron-cored both B/C and S/W Coils, 7-22 meg. S/W, 550-1600 KC B/C band. Special cadmium sub-chassis A.W.A. Air Trimmers. Fixed Mica B/C and S/W Padders fitted. All assemblies pre-aligned on special tester before leaving factory. All coils treated with tritolal and lo-loss wax. A.V.C. resistors and condensers, decoupling resistor in R.F. stage. Easy and comprehensive colour code and lising instruction sheet supplied.

208 LT. LONSDALE ST., MELB.

RETAIL PRICE 140/-.

# AMATEUR RADIO

FEBRUARY

1947

JOURNAL OF THE WIRELESS INSTITUTE OF AUSTRALIA

## An indispensable instrument for the experimenter

To the experimenter the Philips "Philoscope" (A.C. Bridge) Type TA 160 offers seven major features.

- 1 The accuracy is unimpaired by mains voltage fluctuation.
- 2 A calibration system has been incorporated enabling rapid checking of the apparatus at any instant.
- 3 The highly sensitive magic eye indicator facilitates precise balancing of the bridge circuit.
- 4 The sensitivity of the indicator is variable. This is very helpful when measuring components of an unknown value.
- 5 It is not possible to damage the instrument by overloading the indicator or by faulty connections.
- 6 The maximum voltage applied to test components is 3V., or in the case of low resistances, the maximum current is 500mA.
- 7 The apparatus can be operated from 220V., 240V., 260V., 40/50 cycles mains supply.

We will be pleased to supply you with further details on request

# PHILIPS

## PHILOSCOPE TYPE T.A.160

PHILIPS ELECTRICAL INDUSTRIES OF AUSTRALIA PTY LTD  
SYDNEY MELBOURNE ADELAIDE PERTH BRISBANE



FOR THE EXPERIMENTER & RADIO ENTHUSIAST

Registered at G.P.O., Melbourne, for transmission by post as a periodical.

6d.

KP3

## LET'S GET TO THE CORE OF THINGS

As with all KINGSLEY radio products the reason why "PERMACLAD" I.F.'s are now spoken of as the best in Australia is found in the ferromagnetic iron-dust cores used in their construction. Apart from the inherent technical superiority of iron-core tuning, every "PERMACLAD" I.F. is turned out on a production line that sets a particularly high standard of quality.

So from the first to the final step . . . that of oscillagraph testing and tuning . . . each I.F. is made to give the absolute maximum in performance. The use of the enclosed pot-type ferromagnetic cores give KINGSLEY PERMACLAD I.F.'s a particularly high degree of permeability, high "Q" and gain.

OBTAINABLE FROM  
AUTHORISED KINGSLEY DISTRIBUTORS

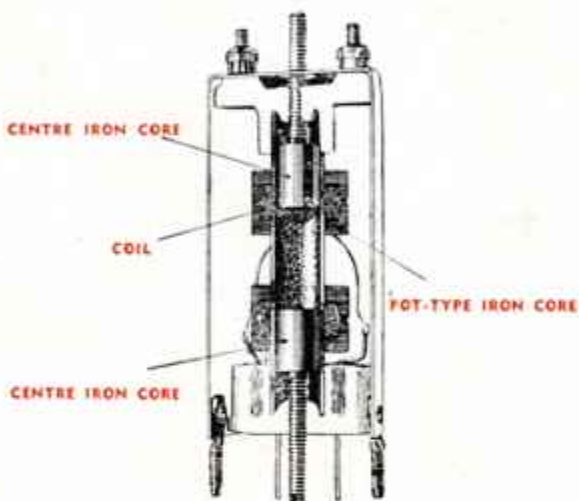

The above diagram is a cut away sketch of a PERMACLAD I.F. Tuning is done by the two centre iron-cores.

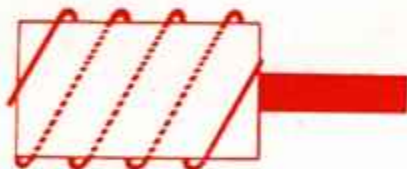

**F E R R O T U N E**  
FERRO-MAGNETIC IRON-CORE COILS, I.F.'s AND,  
GANGLESS TUNING UNITS



# KINGSLEY RADIO

KINGSLEY RADIO PTY. LTD.

380 St. Kilda Road, Melbourne, Victoria . Phones: MX 1159, MX 3653

# AMATEUR RADIO

VOL. 15

FEBRUARY, 1947

No. 2

Published by

THE WIRELESS INSTITUTE  
OF AUSTRALIA

191 Queen St., Melbourne, C.1.

Editor:

T. D. HOGAN, VK3HX  
Phone: UM 1732

Technical Editor:

J. K. RIDGWAY, VK3CR

Distribution:

H. N. STEVENS, VK3JO

Business Manager:

J. G. MARSLAND, VK3NY

Advertising Representative:

W. J. LEWIS  
20 Queen St., Melbourne, C.1.

Printers:

H. Hearne & Co. Pty. Ltd.  
285 Latrobe St., Melbourne, C.1.

Mss. and Magazine Correspondence should be forwarded to the Editor, "Amateur Radio," Box 2611 W.G.P.O., Melbourne, C.1. on or before the 15th of each month.

Subscription rate is 6/- per annum in advance (post paid).

## Editorial

How many of us keep up to date with modern radio technique? How will these techniques affect Amateur Radio? Here are two questions which warrant a little "pondering upon."

Some of us who had no opportunity of participating in the rapid development of electronics during the last five or six years are perhaps a little bewildered by wave guides and cavity resonators. It may be many moons before these devices find a place on the back lawn or in the junk box of the "average ham"—but at least he might like to know what they look like now.

The Wireless Institute has among its members, amateurs who are well equipped to "tell us about it," either by lectures or articles in this Journal.

A progressive technical education policy within the Institute will ensure that members are able to make adequate use of those "new" frequencies and methods of transmission and reception, the allocation of which for Amateur purposes your Federal Executive is keeping an eye on.

E. D. T.

### IN THIS ISSUE

Clearing the Ether, Part VIII: .....	3	Divisional Notes:—	
The Folded Dipole .....	5	New South Wales .....	14
Propagation Predictions for February .....	8	Victoria .....	14
Federal Notes .....	9	Queensland .....	19
Fifty and Up .....	10	South Australia .....	19
Federal QSL Bureau .....	12	Tasmania .....	20
International Amateur Frequency Allocations .....	13	Low Voltage Soldering Irons .....	23
		807's As Zero Bias Triodes .....	24

# RADIO ENTHUSIASTS!

# SEE THESE STAR SPECIALS AT HOMECRAFTS!

- ★ **EIMAC TRANSMITTING TUBES.** Write for new Characteristics Handbook.
- ★ **DISPOSALS BARGAIN.** F.S.6 Transceivers, Remote Controls, Parts, etc.
- ★ **QUARTZ CRYSTALS.** A big selection at reasonable prices.
- ★ **HOMECRAFTS VALVE CHART.** A huge wall chart giving instant reference to all characteristics.
- ★ **AUSTRALIA'S WIDEST RANGE OF RADIO PARTS.**

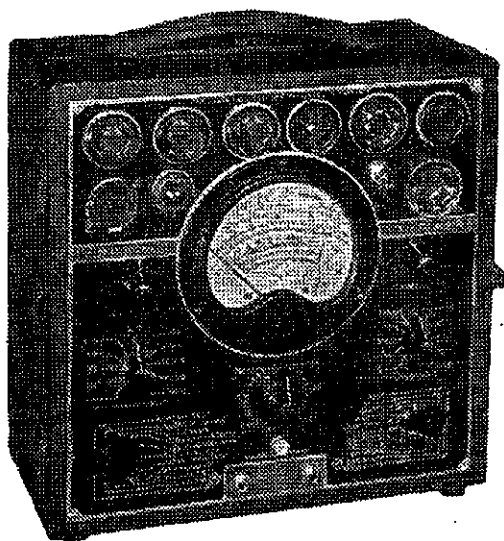

## "PALEC" TEST EQUIPMENT

**VCT TESTER** Operates from 50 cycle A.C. mains with voltage from 200 to 250. Sturdy construction for lifetime service 11" x 7". Weight 16½ lbs. Also available in battery operated model.

**NEW OSCILLATORS NOW AVAILABLE WITH OUTPUT METER.**

**YOU'LL SEE IT SOON — HOMECRAFTS CATALOGUE FOR 1947**

*The Radio Specialists*

# HOMECRAFTS PTY. LTD.

Head Office:—MELBOURNE. 290 Lonsdale Street and at 211 Swanston Street, Melbourne.  
139 Moorabool Street, GEELONG. 307 Sturt Street, BALLARAT. 100 Clarence Street,  
SYDNEY. 26 Hunter Street, NEWCASTLE. Hobart, Launceston and Burnie, TASMANIA.

**IF IT'S ELECTRICAL — TRY HOMECRAFTS FIRST!**



## CLEARING THE ETHER.—Series II, Part VIII

By G. GLOVER, VK3AG\*

### Construction and Operation of Modern Transmitter—(Continued)

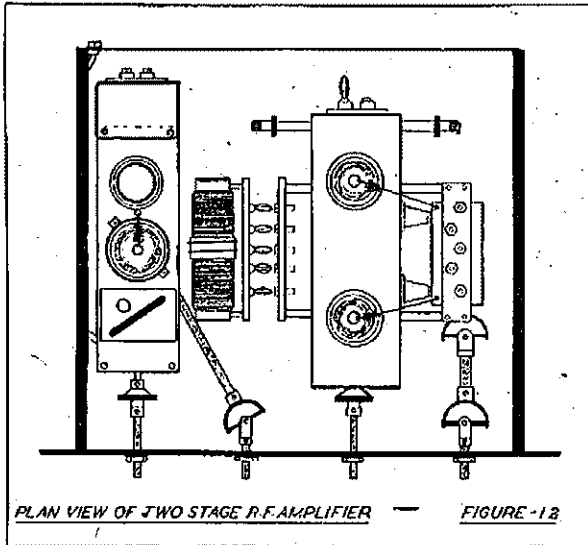

with maintaining maximum economy. Admittedly there are times when the simultaneous observation of both grid and anode currents facilitates detection of spurious oscillations; but usually these conditions only arise during initial tests of new equipment; hence, temporary connection of external instrument suffices.

**Electrical Aspects of Coil Units for First Stage.**—Both the input and output units for lower frequencies are equipped with parallel fixed or variable capacitors to permit main tuning capacitor to cover the desired frequency band, and at the same time provide required minimum capacity. For economy sake the fixed capacitor may comprise a number of small standard silvered-mica receiver type units arranged in series to withstand applied power. The writer uses the term "power" advisedly; because it is necessary to cope with both R.F. voltage developed across the tank circuit, and the heat generated by the circulatory current (refer to part 2 of this series).

In the case of output units, the coils are not enclosed in cans and in the case of lower frequency units, shunt capacitors may be dropped out of circuit for frequency doubling, thus reducing number of units required to cover desired range.

**Mechanical Aspects of First Stage.**—All components are mounted on 16 gauge steel plate (cadmium plated) measuring 3-in. by 9½-in., which in turn is mounted on four 3/8-in. by 3¼-in. brass pillars. As can be seen from Figure 12, the input tuning unit socket is arranged at front end of unit with its tuning capacitor mounted immediately underneath.

The tube socket is mounted in the centre with associated by-pass condensers and suppressor resistor mounted immediately on socket legs, while resistors are mounted on bakelite strip placed astride the underside of the socket. Anode coil socket is at rear end of unit with its tuning capacitor and by-pass condenser mounted directly underneath. The anode lead is taken through the metal plate via polystyrene insulator to pigtail which terminates in suppressor unit mounted on anode clip. The anode circuit is kept as far from grid and cathode circuit components as possible, in addition a tubular shield is provided around tube to suppress spurious oscillation.

The main advantage claimed for this set-up is the ease with which it can be wired or serviced, and the shortness of all electrical connections. To connect the grid tuning capacitor through front panel to dial, only a flexible insulated coupling is required. The anode capacitor however is a horse of a different color; here we have sacrificed mechanical simplicity for electrical efficiency; therefore, in order to maintain symmetry of our front panel we must employ two "knuckle" or "universal" couplings, and insulated interconnecting shaft to transmit dial motion to the capacitor. Not a very heavy price to pay for high electrical efficiency.

R.F. input socket is screwed to left side of main chassis assembly and connected to input tuning socket by short length of 75 ohm co-axial cable. R.F. output and power sockets are arranged on apron at the rear of unit.

**Mechanical Aspects of Coil Units for First Stage.**—Input units: coils and capacitors are mounted in similar manner to that employed in B.F.G.; but are arranged in

**Practical Construction of 2 Stage R.F. Amplifier Unit:** In the preceding sub-sections the author has covered most of the theoretical aspects of R.F. Amplifier design. The practical unit about to be discussed represents one method of attacking the problem, and the reasons for adopting various mechanical and electrical set-ups will be explained in the text.

**General Construction.**—Figure 12 portrays completed unit and the study of same will reveal that the two stages, which we will refer to as first and second stages respectively, sit side by side on tray in standard, 6 unit, relay rack panel assembly. Each stage is arranged so that it may be patched in or out of circuit to facilitate experimentation.

**Electrical Circuit of First Stage.**—As depicted in Figure 13 the electrical circuit of the first stage is comparatively simple. The input circuit is link coupled to the exciter unit. A type 807 tube is employed and the output circuit is link coupled to the second stage. In order to eliminate self-oscillation near the operating frequency, a balanced tank is employed, stray capacity serving as neutralising element. The 2000 ohm resistor incorporated in the screen grid circuit merely serves as decoupling agent, the circuit is carried to the control panel so that if desired keying can be accomplished by applying negative voltage to this electrode. The metering leads, which also go away to the control panel, could be arranged so that grid current did not flow through cathode shunt; however as the grid current is so small in comparison with total cathode current this is not considered necessary. If desired individual meters can be placed on panel instead of employing central meter; however here we are concerned

\*Glorad Engineering Services.

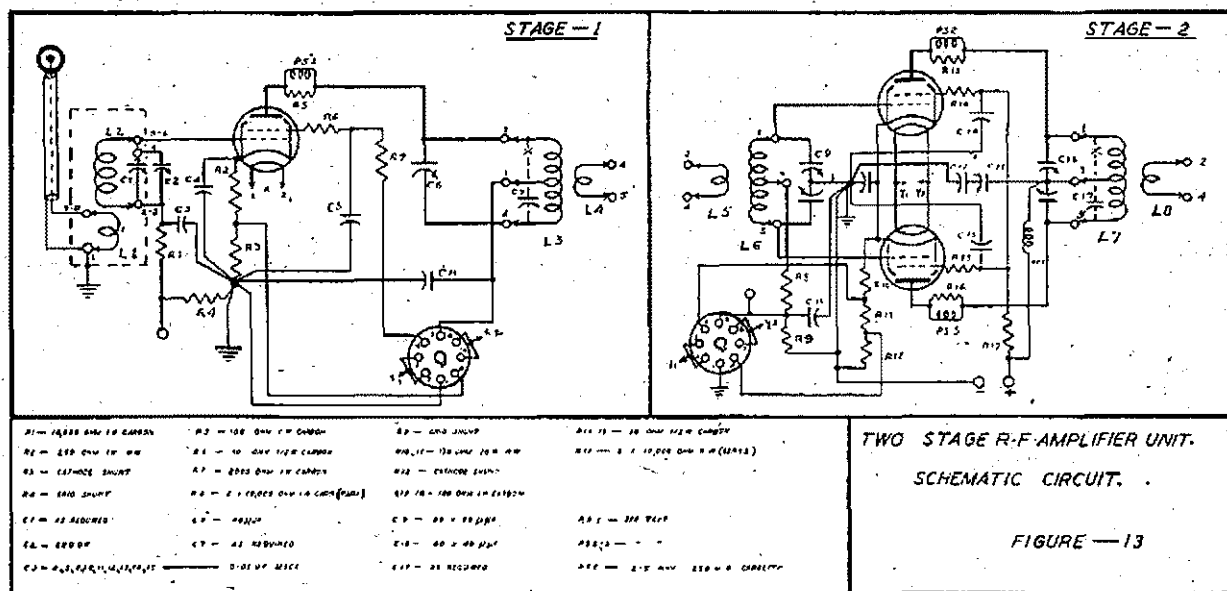

larger type of shielding can; that is, 2-in. x 3-in. x 4½-in. high. Link is wound over cold end of grid coil.

**Output units:** Comprised 1½-in. diameter paper-based bakelite tubing 3½-in. long, slipped over 5 pin Mycanol 807 base for lower frequencies. A polystyrene or ceramic former may be used for higher frequencies. In this unit the link is wound over centre of each coil, and additional capacitors are mounted on coil according to requirements.

**Operation of First Stage.**—In operation this stage may be used to:—

- Drive second stage.
- Excite antenna, that is, it may be used as final stage, thus enabling the constructor to limit construction to this stage until finance and time permits addition of second stage.
- Drive another stage arranged on separate unit as alternative set-up.
- Amplify either the fundamental frequency or harmonic thereof. Good output is obtainable on fundamental, second, and third harmonics.

**Bugs, Bugs, Bugs**—This can, without fear of contradiction, be called the most important indication of success or failure of any design. The following bugs appeared during initial tests and were eliminated by the means indicated.

- Self Oscillation Near Operating Frequency.**—Cured by adding tubular shielding around tube and employing balanced anode tank depicted in Figure 13.
- Spurious Oscillation in Screen Grid/Anode Circuit.**—Eliminated when 50 ohm stopper resistor was inserted between screen grid of tube and associated by-pass condenser, plus addition of tube shield.

**Electrical Circuit of Second Stage** is illustrated in Figure 13. The electrical circuit of this stage is also comparatively simple. The input circuit being link coupled to the first stage. Two type 807s are used in push-pull circuit for straight amplification and in push-push for doubling. The output circuit is link coupled to the antenna tuner, or may likewise be coupled to further stage for frequency multiplication, etc.

As this stage is designed with a view to anode modulation (amplitude) the screen grid is connected to anode supply via dropping resistor. Cathode biasing resistor comprises two 150 ohm units in series. One unit being short circuited for C.W. operation at full power. Metering leads, see remarks under first stage.

**Electrical Aspects of Tuning Units of Second Stage.**—As in the case of first stage, lower frequency input and output units are equipped with parallel fixed capacitors to provide required minimum capacity or "Q" Factor.

**Mechanical Aspects of Second Stage.**—All components in this case are mounted in 16 gauge steel cadmium plated box of unusual construction. The sides of box measuring 10-in. x 5½-in. Plate similar to that employed for first stage is mounted at point two inches below the top edge, and serves to mount tube sockets, associated stopper resistors, by-pass condensers and dropping resistors. The grid tuning capacitor is mounted underneath the centre of plate and attached to dial via insulated flexible coupling. False cover shown provides necessary shielding for tubes, cathode and screen resistors, and serves as mounting for power sockets.

Grid coil mount projects from the left side of unit, and it consists of a bar of polystyrene having five jacks to receive coil unit. It is mounted on brass spacers by the use of long metal thread screws and nuts. In Figure 12 coil is shown with plugs just entering jacks with a view to conveying picture of type of plug employed. Grid resistor mounts directly between the centre jack and by-pass condenser.

Anode coil mount is supported by brackets from the right side of unit. The bar takes the same form as that for grid coil, and in this instance coil has been removed to show layout of jacks.

Anode tuning capacitor is mounted on stand-off insulators immediately below coil jack bar, and with it is associated anode by-pass condenser and R.F. choke; thus providing adequate isolation between grid and anode circuits. In order to reduce length of anode tank leads to a minimum, capacitor has been mounted without regard for alignment of dial shaft, hence two universal couplings and insulated inter-connecting shaft are required; however, the shorter leads enable unit to be operated efficiently at higher frequency so that the additional expense is well merited.

Continued on Page 21

# THE FOLDED DIPOLE

By GEORGE H. CHOULES, VK3AIB\*

Much discussion has taken place in Amateur circles re this novel form of impedance matching antenna. As the writer had ideas of building a rotary beam antenna for 28 Mc., notes were taken of these discussions, and all available text books were scanned for the "real dope." After collating the various ideas, rumours and miscellaneous scraps of information, the nett result appeared to be almost nil, as quite a lot of the "evidence" appeared to be conflicting.

A further period of intensive "bookworming" ensued and at last a ray of light appeared in the form of the following statement by one of R.C.A.'s foremost antenna experts.

Extract from an article by P. S. Carter, R.C.A. Review, October, 1939:—

"This type of antenna consists of two closely spaced half-wave dipoles connected together at their ends. One of the dipoles is broken at its center and fed from a balanced transmission line. The instantaneous currents in both units are in the same direction in space while both are flowing toward a nodal point at one extremity of the radiating structure. The current distribution does not differ greatly from that of an ordinary half-wave dipole and is approximately sinusoidal.

"Since the two radiators are very closely spaced in terms of wavelength the radiation pattern is essentially the same as the pattern of an ordinary half-wave dipole. The total power radiated per total loop circuit squared, or radiation resistance, is therefore about 73 ohms. However if the diameters of the two radiators are equal, this same radiated power is equivalent to a radiation resistance with respect to the current in one branch, of four times 73 ohms or 292 ohms. The latter value of resistance is that which is seen by the transmission line at its terminals. This type of antenna thus serves the double purpose of a radiator and impedance matching transformer.

"When three radiators of equal diameters are arranged in accordance with this method, a transformation ratio of nine is obtained. Any desired ratio of transformation may be obtained by the use of two or more radiators of unequal diameters. In such an arrangement of two units wherein the smaller diameter conductor is fed from the transmission line, the transformation ratio is greater than four, since the greater of the two currents flows along the larger conductor."

Unfortunately, Mr. Carter did not elaborate on his theme of unequal diameters and no formulae were given. After several perusals of the above statement, and the burning of much midnight oil, the writer managed to derive a formula relating the diameter ratio of the conductors to the impedance "step-up" to be obtained with respect to an ordinary half-wave dipole.

Here it is, together with the reasoning which led to its derivation.

Consider an ordinary half-wave dipole in free space, and assume a certain power input to the feeder which will cause a current of one ampere to flow at the centre of the dipole. If the feeder is completely "flat" or non-reactive, the radiated power will be proportional to the square of this centre current multiplied by the radiation resistance at the centre of the dipole, which, for the purpose of this discussion, we will assume to be 73 ohms.

$$\begin{aligned} \text{Thus, } W &= I^2 R = 1^2 \times 73 = 73 \text{ Watts} \\ \text{and } R &= W/I^2 = 73/1^2 = 73 \text{ Ohms} \\ &\text{Equals Centre Impedance of Dipole, } Z_l \end{aligned}$$

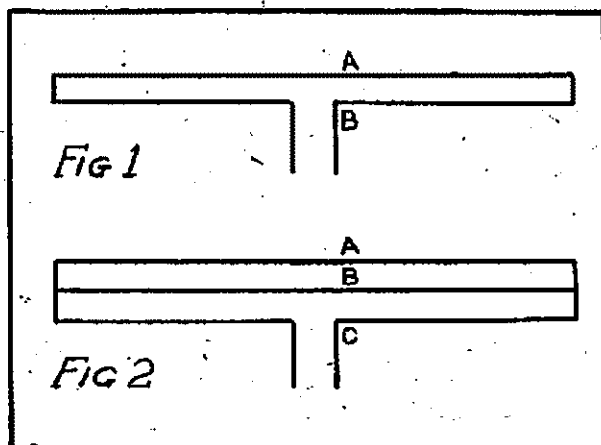

Assuming the surge impedance of the feeder to be 73 Ohms we have a perfect impedance match.

e.g. centre impedance of dipole =  $Z_l = 73$  Ohms.

surge impedance of feeder =  $Z_o = 73$  Ohms.

Impedance ratio  $Z_l/Z_o = 73/73 = 1/1$ .

If we now "fold" the dipole, as in Figure 1, and make the diameter of each conductor identical it will be seen that the conditions have now changed considerably. Assuming the same power input to the antenna as before, the centre current  $I = 1$  ampere, will now divide in proportion to the conductivity or sectional area of each conductor.

Since the diameters are equal, the areas will be equal and half the total current, 0.5 ampere will flow in each conductor.

Also, since the two conductors are spaced only a small fraction of a wavelength, the centre impedance of the antenna as a whole is still 73 ohms. (Carter, par. 3.)

But the feeder is attached to only one conductor so that the impedance looking into the centre of this conductor will be proportional to its current squared, with respect to the total antenna impedance of 73 ohms.

Since the total radiated power is the same as before, e.g. 73 watts, but the current in one conductor (the driven one) is now only 0.5 ampere.

$$Z_l = W/I^2 = 73/.5^2 = 73/.25 = 292 \text{ Ohms.}$$

and the impedance ratio  $Z_l/Z_o = 292/73 = 4/1$ .

Similarly with three conductors each of the same diameter, as in Figure 2. The total current  $I = 1$  ampere, now divides equally in three directions.

A = 0.333 Ampere

B = 0.333 Ampere

C = 0.333 Ampere

and the impedance looking into the centre of C will be  $Z_l = W/I^2 = 73/.333^2 = 73/.111 = 657$  Ohms and the impedance ratio  $Z_l/Z_o = 657/73 = 9/1$ .

It can also be shown that in the case of a four conductor dipole, the impedance ratio is 16/1.

It can now be seen that in the case of Figure 1, the

\*37 Howitt Road, Caulfield, S.E.7, Victoria.

impedance ratio is proportional to the sectional areas of A and B. Thus—

$$\left[ \left( \frac{A}{B} \right) + 1 \right]^2 = \left[ \left( \frac{1}{1} \right) + 1 \right]^2 = (1 + 1)^2 = 4$$

and in the case of Figure 2—

$$\left[ \left( \frac{A+B}{C} \right) + 1 \right]^2 = \left[ \left( \frac{1}{1+1} \right) + 1 \right]^2 = (2 + 1)^2 = 9$$

If now, in the case of Figure 2, we combine the conductors A and B into one conductor with the same sectional area of A + B, we have a conductor D, of equivalent conductivity to that of A and B in parallel, and 2/3 of the total current will flow in it, leaving 1/3 to flow in C as before, and the centre impedance of C is the same, as in Figure 2.

So that we can now write,

$$\text{Impedance ratio } Z_1/Z_0 = \left[ \left( \frac{D}{C} \right) + 1 \right]^2$$

Where D = Sectional area of the folded conductor.

C = Sectional area of the driven conductor.

Since the area ratio is the square of the diameter ratio, this becomes,

$$Z_1/Z_0 = \left[ \left( \frac{D}{C} \right)^2 + 1 \right]^2$$

Where D = diameter of the folded conductor.

C = diameter of the driven conductor.

This relationship holds whether the conductors are of solid or tubular section, provided that the wall thicknesses of the tubular conductors are similar, as Radio Frequency currents travel mostly on the surface.

For ease of working out practical examples we can now transpose the above formula and write,

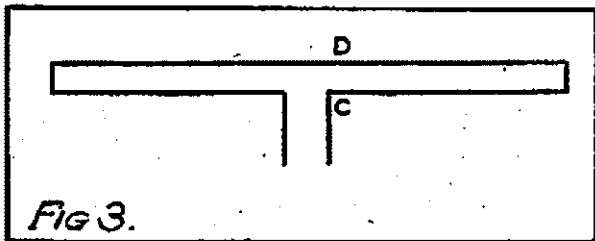

Fig 3.

$$\text{Area ratio } D/C = \left( \sqrt{\frac{Z_0}{Z_1}} \right) - 1$$

Where  $Z_0$  = surge impedance of cable

$Z_1$  = beam input impedance

and diameter ratio =  $\sqrt[3]{\text{area ratio}}$ .

We can now proceed to work out some practical examples as applied to the matching of beam antennae to a co-axial feeder.

Take, for instance, a three element beam with conventional spacing of .1 wavelength for the director and .15 wavelength for the reflector.

The A.R.R.L. Antenna Handbook states the beam input impedance to be between 8 and 10 ohms. For ease of calculation we will assume it to be 9 ohms and the surge impedance of the feeder to be 72 ohms. The impedance ratio is seen to be  $72/9 = 8/1$ .

We have some  $\frac{3}{8}$ -inch diameter tubing for the elements and wish to find the correct diameter of tubing to use for the driven element so that a correct match is obtained to a 72 ohm cable.

From the formula,

$$\text{area ratio } D/C = \left( \sqrt{\frac{Z_0}{Z_1}} \right) - 1 = \left( \sqrt{\frac{72}{9}} \right) - 1$$

$$\text{equals } (\sqrt[3]{8}) - 1 = 2.83 - 1 = 1.83$$

$$\text{diameter ratio } D/C = \sqrt[3]{1.83} = 1.35/1.$$

The diameter of D = 0.75-inch

$$\text{therefore diameter of } C = \frac{0.75}{1.35} = 0.555\text{-inch.}$$

The nearest stock size of tubing is 0.5625-inch, that is  $\frac{9}{16}$ -inch diameter.

Similarly for a four element beam with an input impedance of say, 6 ohms, and using  $\frac{3}{8}$ -inch diameter elements (the writer's case):—

$$\frac{Z_0}{Z_1} = \frac{72}{6} = 12/1$$

$$\text{area ratio } D/C \left( \sqrt{\frac{Z_0}{Z_1}} \right) - 1 = (\sqrt{12}) - 1 = 2.47$$

$$\text{diameter ratio} = \sqrt[3]{2.47} = 1.57/1.$$

The diameter of D = .375-inch

$$\text{therefore diameter of driven conductor} = \frac{.375}{1.57} = 0.240\text{-in.}$$

The nearest stock size of tubing is .25-inch, that is  $\frac{1}{4}$ -inch diameter.

If it is desired to find the impedance relations in an existing set-up we can use the formula,

$$Z_1/Z_0 \left[ \left( \frac{D}{C} \right)^2 + 1 \right]^2$$

where D = diameter of folded conductor

C = diameter of driven conductor.

In a three element beam with conventional spacing, if say, the elements are of  $\frac{3}{8}$ -inch diameter tubing and the driven element is of  $\frac{1}{4}$ -inch diameter tubing, we have,

D = 0.75-inch diameter

C = 0.25-inch diameter

$Z_1$  = 9 ohms

$Z_0$  = 72 ohms

$$\text{Impedance ratio } Z_1/Z_0 \left[ \left( \frac{.75}{.25} \right)^2 + 1 \right]^2$$

$$\text{equals } (3^2 + 1)^2 = 10^2 = 100/1.$$

So that when the beam input impedance  $Z_1 = 9$  ohms is multiplied by this ratio it becomes 900 ohms, which is the impedance the 72 ohm cable is looking into. An impossible situation, as due to factors which will not be discussed here, the maximum practical impedance step-up to be obtained with a folded dipole is of the order of 20/1.

The writer is aware that some controversial points arise in the above discussion but he feels that it is at least, a practical approach to a problem on which little information is available. His four element beam, designed according to the foregoing formulae, is completely non-reactive at the operating frequency, draws power remarkably well and has worked an impressive list of G stations on 28 Mc. In view of this performance, the writer feels that the burning of the aforementioned midnight oil was not entirely wasted.

It is emphasised that the above relations do not hold if the beam is closer than  $\frac{1}{4}$  to 1 wavelength to surrounding objects such as roofs, etc., as, under these conditions, the objects act as additional parasitic antennae of unknown characteristics and the entire set-up of self and mutual impedances is completely disorganised.

# A.G. HEALING

LIMITED

MANUFACTURERS AND  
DISTRIBUTORS FOR . . . . .

Electrical and Testing Instruments for all purposes made to British Standard specifications. Each instrument is accurate, + or —, to 2 per cent., and parts are heavily plated to prevent corrosion even under tropical conditions. "Healing" Electrical Meters equal the best imported types and will give accurate service for long periods under the most exacting conditions.



No. 10A round production mounting Black Bakelite Case.

Type No. 30A 4" square semi-flush Black Bakelite Case.

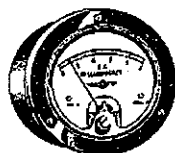
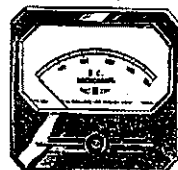

No. 20A 2½" round flush mounting Black Bakelite Case.

These, and all other Healing Radio Electrical Testing Units, are manufactured in our own factories and available from A. G. Healing Ltd.

OTHER INSTRUMENTS INCLUDE:

Oscillators — Multi-Testers — Signal Tracers, etc.

ALSO MANUFACTURERS AND DISTRIBUTORS FOR

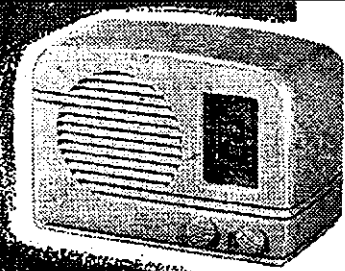

## Golden Voice RADIO

A. G. HEALING LTD., MELBOURNE, SYDNEY, ADELAIDE

# PROPAGATION PREDICTIONS FOR FEBRUARY, 1947

We are happy to announce the re-commencement of these monthly predictions which were discontinued in September, 1946, owing to lack of space, but which apparently have been missed by quite a number of readers.

For the benefit of new readers it might be advisable at this juncture to explain how these predictions are made and how they can be applied to amateur work.

The information contained in these predictions is taken from a monthly publication known as the Radio Propagation Bulletin, issued by the Australian Radio Propagation Committee of the Radio Research Board of the Council for Scientific and Industrial Research. These Bulletins are compiled from information on ionospheric conditions received from observation stations in all parts of the world and from the Commonwealth Solar Observatory at Mount Stromlo. From a close observation of all the information received from these stations it is possible to issue forecasts with a high degree of accuracy as far ahead as six weeks from the date of publication.

The Bulletins contain a map of the world divided into various zones, and charts are published for the different latitudes of these zones which give (a) the maximum useable frequency and (b) the optimum working frequency for various skip distances from 0 to 2500 miles for the 24 hour period. The maximum useable frequency, M.U.F., is defined as the highest frequency which may be used with any degree of reliability for any given skip distance; whilst optimum working frequency, O.W.F., is the frequency which will ensure positive and reliable communication at the times stated on the chart. In general the optimum working frequency may be taken to be round about 75-80% of the maximum useable frequency. The propagation predictions are made for transmissions by way of the regular ionospheric layers and graphs are drawn for the F2 layer.

The recent phenomenal conditions on the 50-54 Mc. band were predicted by the Bulletins. Of course it must be realised that freakish conditions such as abnormal magnetic disturbances and local atmospheric conditions which are apt to spring up suddenly cannot be foreseen when the predictions are made.

It is obviously not possible for a complete reprint of these Bulletins to be made in "Amateur Radio," so we shall confine our abstracts to information relative to the amateur bands. It should be noted that where skip distances are given, these only hold good where the point of reflection is in the same zone as the transmitting station and in latitude five degrees either side.

The zone with which we are concerned is Zone E which roughly encompasses an area from longitude 30 degrees East to 180 degrees East, containing Australia, India, China, Asia and the North Western tip of Alaska. Other zones are as follows: Zone I, containing Africa, Europe, New Zealand, Alaska and North Western Canada. Zone W, North and South America and Eastern Canada.

The skip distances given are only for single hop working. Those interested in multi-hop paths are advised to obtain a copy of the Bulletin and to use the transparent sheet provided for the calculation of these paths.

Here then are the propagation predictions for February, 1947, as applied to the amateur bands.

**Zone E.—Latitude 10° South (Northern Queensland, Northern Territory, North Western Australia):—**

Maximum useable frequency 48 Mc., shows skip of 2,500 miles at 1400 hours local time at point of reflection. Optimum working frequency 38 Mc.

7 Mc.—Useless at all times for DX working.

14 Mc.—At midnight shows skip at 500 miles, increasing to about 1,200 miles at 0600 hours, then steadily decreasing until at 1400 hours it is no greater than 200 miles. After this time skip steadily increases to 500 miles at midnight.

28 Mc.—Shows excellent possibilities for DX. At midnight skip is about 1,800 miles, increasing to 2,500 miles at 0200 hours. After this time a fade out occurs until approximately 0800 hours when skip is once again 2,500 miles decreasing to 1,200 miles at 1400 hours and steadily increasing to 1,800 miles at midnight.

**Zone E.—Latitude 20° South (Southern Queensland, New South Wales, South Australia, Southern West Australia):—**

Maximum useable frequency is 40 Mc.

7 Mc.—Shows a peak of up to 500 miles' skip between 0300 hours and 0700 hours, apart from this not much doing.

14 Mc.—At midnight skip is about 800 miles, rising to about 1,400 miles at 0600 hours, then decreasing to 600 miles at 1600 hours, and steadily rising to 800 miles at midnight.

28 Mc.—Dead until 0800 hours, when skip is 2,500 miles decreasing to 1,500 miles at 1500 hours, and increasing to 2,500 miles at 1900 hours after which time another fade out occurs.

**Zone E.—Latitude 30° South (Victoria, Southern N.S.W., Southern S.A., and Southern W.W.):—**

Maximum useable frequency is 32 Mc.

7 Mc.—Useful for skip distances up to 500 miles from 0100 hours to 0700 hours.

14 Mc.—At midnight skip is about 1,200 miles increasing to about 1,800 miles at 0500 hours, then decreasing to 800 miles at 1000 hours. This condition remains fairly static until 1700 hours when skip steadily increases to 1,200 at midnight.

28 Mc.—According to the charts this band may not be very reliable as no graph is shown for 28 Mc. as the optimum working frequency. It may however prove useable for skip of about 1,800 miles from 0900 hours to 1700 hours.

**Zone E.—Latitude 40° South (Tasmania):—**

Maximum useable frequency is 32 Mc.

7 Mc.—OK for skip distances up to 500 miles from midnight to 0700 hours and again from 200 hours to midnight.

14 Mc.—Skip at midnight is 1,300 miles, increasing to 2,000 miles at 0500 hours, then decreasing to 1,000 miles at 0800 hours. This condition holds till 1600 hours when skip drops to 800 miles until 2100 hours then rises to 1300 hours at midnight.

28 Mc.—Not very hopeful. Might possibly be useable for skip of 2,500 miles from 0100 hours till 0200 hours.

The amateur who wishes to make a study of ionospheric conditions, and to apply this knowledge to his hobby to enable him to select the best operating frequency for the respective time of day and distance he wishes to communicate, is earnestly recommended to the study of these Bulletins. Bulletins are obtainable at 2/- per copy from all newsgagents and booksellers. (Wholesale distributors Gordon and Gotch [Aust.] Limited.) A handbook for the interpretation of the Bulletins is also available. Our copy by courtesy of the Council for Scientific and Industrial Research.

## FEDERAL NOTES

### FEDERAL CONVENTION

The annual Federal Convention of the Wireless Institute of Australia is to be held in Melbourne at Easter, commencing on 4th April. If any member has any matter which he desires to submit to the convention he should immediately communicate with his Divisional Council. The Divisional Councils are preparing agenda items now.

### W.A.S. CERTIFICATE

The Wireless Institute of Australia is to establish a Worked All States Certificate for 50 Mc. and above. Federal Executive is seeking a suitable design for this certificate and it has been decided to offer a prize for the best design submitted. Ideas and sketches should be forwarded to Federal Executive, Box 2611W Melbourne, before 31st March. The Federal Convention members will be the judges of the winning entry. Let us see what you would like as a W.A.S. Certificate on your wall.

### DX CENTURY CLUB

An Australian DX Century Club is being inaugurated. The "Century" consists of post-war calls only. We shall have more information for you soon.

### B.E.R.U. CONTESTS, 1947

The Radio Society of Great Britain has sent us some entry forms for the B.E.R.U. contests to be held in April. If you are taking part in these contests you can obtain an entry form which contains all the rules, from Federal Executive or the Divisional Secretaries. The following are some extracts of the rules:—

The event will be divided into three sections, namely:—

- Senior (high power) transmitting contest.
- Junior (low power) transmitting contest.
- Reception contest.

In Australia the contest is open only to financial members of the Wireless Institute of Australia. A trophy will be awarded to the fully paid up member of the R.S.G.B. scoring the highest number of points in each section of the contest. Certificates of merit will be awarded to the first three stations in each contest, and also to the leading station in each Prefix Zone, providing at least three entries have been received from the Zone in question.

The judging will be carried out by the R.S.G.B. Contests Committee. The President's decision will be final in all cases of dispute.

The High Power Transmitting Contest will extend from 0001 G.M.T., Saturday, 12th April, to 2400 G.M.T., Tuesday, 15th April, 1947. A maximum of 30 hours operation may be selected from the total 96.

Any amateur frequency band may be used provided the input to the final amplifier is not in excess of that specified on the competitor's licence and in no case more than 150 watts.

The Low Power Transmitting Contest will extend from 0001 G.M.T., Thursday, 17th April, to 2400 G.M.T., Sunday, 20th April, 1947.

The Reception Contest extends from 0001 G.M.T., 12th April to 2400 G.M.T., 20th April, excluding Wednesday, 16th April.

To claim points the following information must be logged:—

- Call of station heard.
- Call of station being worked.
- Entrant's report on the signals of the station heard—readability, strength, tone.
- The serial number given by the station heard to the station being worked.

The same station may only be logged once on each band during each section of the contest.

Please obtain your entry form early so that more forms can be secured from the R.S.G.B. in time for the contest.

## Australia's Largest Stock OF ALL RADIO COMPONENTS

Chokes	Resistors
Coils	Soldering Irons
Condensers	Speakers
Dials	Test Equipment
Intermediate Transformers	Valves
Morse Equipment	Pick-Ups
Potentiometers	Power Transformers
etc. etc.	etc. etc.

Obtainable from

### BLOCH & GERBER LTD.

with which is associated the

### WELDON ELECTRIC SUPPLY CO.

46-48 YORK STREET SYDNEY

G.P.O. Box 2282 M

Phones: MA 6291 (10 lines)

## NEW ULTRA COMPACT HIGH-Q AIR CAPACITOR

Of unusually high-Q and extraordinary mechanical and electrical stability, the new air-dielectric capacitor released by Philips Electrica Industries is assured of a ready market.

Developed and produced at the famous Philips works in Holland, it is now available to Australian set makers, servicemen, and experimenters. Small in size—less than one-half inch in diameter and 1-7/16 inches in length—it is useful to beyond 500 megacycles. This capacitor provides 3 to 30 mmfd. with air and high quality ceramic insulation. Special features are the construction of rotor and stator in one piece, low inductance, multiple aluminium cups. Rotor meshing with stator gives a linear capacitance range of 27 mmfd. over three full rotations. Adjustment is permanent by virtue of a retention spring. It will be found that vibration does not affect capacitance since a long rotor bearing sleeve closely hugs a matching central ceramic insulator.

These capacitors have two solder terminals. They are so light that they may be mounted directly by connecting leads, although each can be supplied with a low-loss phenolic mounting plate.

The mechanical construction is such that adjustment of this trimmer is immeasurably more simple than with other currently available types. Persistence of the original setting, despite severe vibration, is another feature of this capacitor.

Philips advise that ample stocks of these trimmers are now to hand.

## VICTORIA

DX since the last notes were published was as follows: Monday, 30th December, at 6 p.m. the writer (3NW) contacted VK4HR. Conditions were not very good and signals lasted only 15 minutes. Sunday, 5th January, VK4s came in well in the morning about 11 a.m. for some time and several contacts were made. Again at 6 p.m. two or three stations were heard. Sunday, 12th, VK3MJ heard 2AZ and 2WJ working duplex, no contacts so far as is known. Monday, 20th, at about 8 p.m. VK7CW was heard at R9 plus working 2NO and later 2LZ. At the same time 7NC. was heard calling CQ on CW at R8/9. Although a number of Melbourne stations, including 3MJ, 3HK, 3YJ and the writer (3NW) called both these stations no contacts were made. Apparently the two VK7s were too busy with the VK2s. Signals disappeared about 15 minutes later.

An interesting report comes from VK5QR during the month. He reported hearing 3ABA at about R4 on 26th December and later on 9th January he heard 3IZ and 3DA both at R9 or more. Apparently there was an opening for VK5s at both those times but nobody here was listening. Which all goes to show that we will have to be more systematic in our watching and keep those beams turning!

We regret having to report that Dave (3MJ) has had to retire temporarily from the radio field owing to pressure of work. Everyone will miss the ether-splitting 3MJ signal and the band will not be the same without this very active station. We hope the busy time will pass

and that Dave will soon take his place again on the air and in the W.I.A. meetings. Another signal that will not be heard very often during the coming year is that of 3ZD. Ron is to be busy with studies and is giving up the amateur game for the forthcoming twelve months. We wish him all the best and hope to hear him when work permits.

Several signals that were heard on the 50 Mc. band during last year and which disappeared after a few contacts, have been on lately. 3DA, 3TQ and 3XM are becoming more active and 3TD and 3RO are some of the latest to put in an appearance. Welcome to all these fellows.

3NW is still having very good cross-band duplex contacts with 3YS on 166 Mc. and 50 Mc. 3YS now receives the 166 Mc. signal at R8/9 on his "rush box." The 50 Mc. receiver at 3NW has been fitted with plug in coils and now covers both these bands. It appears to perform satisfactorily on 166 Mc. and it was interesting to check the stability of the HY615 linear osc. and 832 P.A. combination with it. Over a distance of three miles the signal was R9 plus without any antenna and the stability was such that it could not have been distinguished from crystal control using the 1600 Kc. LF. channel on the receiver. A corner reflector has been built and tried out under very adverse circumstances, during which no increase was noted at 3YS! However it is believed that lack of gain was due to the fact that the corner reflector was considerably lower than the co-axial dipole and had a number of stray wires across its "mouth."

## TECHNICAL BOOK & MAGAZINE CO.

297-299 SWANSTON STREET, MELBOURNE

(Opposite Old Melbourne Hospital)

Central 2041, Melbourne, C.I

We can arrange subscriptions to any of the following magazines:

### AMERICAN.

RADIO: .....	25/- year	COMMUNICATIONS: .....	24/- year
Q.S.T.: .....	27/- "	RADIO NEWS: .....	32/- "
C.Q.: .....	20/- "	RADIO CRAFT: .....	22/- "
SERVICE: .....	24/- "	SCIENCE DIGEST: .....	23/6 "
F.M. & TELEVISION: .....	48/- "	PROCEEDINGS INST. OF RADIO ENGINEERS .....	88/- "
ELECTRONICS: .....	97/6 "	POPULAR SCIENCE: .....	23/6 "
SPECIAL RATE FOR THREE YEARS: ..	195/-	POPULAR MECHANICS: .....	23/6 "

### ENGLISH AND AUSTRALIAN.

WIRELESS WORLD: .....	25/- year	WIRELESS ENGINEER: .....	42/- year
PRACTICAL WIRELESS: .....	13/6 "	ELECTRONIC ENGINEERING: .....	33/- "
AUST. RADIO WORLD: .....	10/6 "	RADIO AND HOBBIES: .....	6/6 "
AMATEUR RADIO: .....	6/- "	SHORTWAVE MAGAZINE (English): ..	25/6 "

Just published by P.M.G.'s Dept.

LIST OF EXPERIMENTAL STATIONS IN AUSTRALIA.

2/-d. each; Postage 2½d.

FOREMOST IN AUSTRALIA FOR TECHNICAL BOOKS.



**KEITH HARRIS & CO. PTY. LTD.**

51 WILLIAM STREET, MELBOURNE.

HAVE PLEASURE IN ADVISING THAT

**EDDYSTONE**

COMPONENTS ARE NOW AVAILABLE AT

**JOHN MARTIN PTY. LTD.**  
116-118 Clarence Street  
SYDNEY, N.S.W.

**CHANDLERS PTY. LTD.**  
Cnr. Albert and Charlotte Streets  
BRISBANE, Q'LAND.

**J. H. MAGRATH & CO.**  
208 Little Lonsdale Street,  
MELBOURNE, VIC.

**W. & G. GENDERS PTY. LTD.**  
Cameron Street,  
LAUNCESTON, TAS.

**GERARD & GOODMAN LTD.**  
Rundle Street,  
ADELAIDE, S.A.

**CARLYLE & CO.**  
915-917 Hay Street,  
PERTH, W.A.

A very good signal on 50 Mc. is that of Rex (3IZ) at Red Hill, who is experimenting with various beams and is active on the band almost every night. He is always R9 plus and uses a T55 in the final with 50 watts input. This is driven by the following exciter line up: 6V6GT osc. doubler (3.6 Mc. crystal), 6V6 dblr., 6L6 dblr., 807 dblr. Series modulation is used. Rex is doing good work on the receiving side with a super regen.

Very little is heard these days from Arch (3BW) whose signals used to be very reliable and a number of country stations who were planning to make an appearance on the band have not yet done so. Signals heard during the month include VK3s: MJ, KU, YS, ABA, XM, OT, MB, TQ, LR, NW, HK, DH, BW, IZ, DA, YJ, TD, PK and ZD.

**QUEENSLAND**

The past month has seen a continuance of DX conditions on 50 Mc. in VK4, the best effort of the month (to my knowledge) being VK4HR's contacts with VK5QR and VK5GF on the evening of Wednesday, 8th January. VK2s were also heard a-plenty on this occasion. VK5 signals were heard again on the night of Sunday, 12th January, as were VK2 and VK3 signals.

VK4HR, who has been in a position to keep a fairly constant watch on the band, reports that he has on many occasions heard DX stations flash through for a few seconds only to vanish just as quickly. The band opened up

on Xmas morning apparently for the express purpose of letting 4FB wish 3MJ the Seasons Greetings, and then again cut loose on the 27th December when VK3s came through in great style. Two additional calls on the band are 4TR and 4KB, although the latter is not permanently installed as yet.

A recent visit to Bundaberg revealed considerable interest in 50 Mc. in that City; 4PG, 4BJ and 4UX being active. Skeds with Brisbane have so far been fruitless although 4PG has of course worked DX, 4PG's signal was heard in Brisbane on 5th January by 4HR.

The 166 Mc. band has been torn asunder by 4FB and 4XG, who thus share the distinction of having a whole band to themselves. They are calling for recruits however, as more population is needed.

**SOUTH AUSTRALIA**

Christmas Day was the first occasion that Interstate signals were heard on 50 Mc. in VK5. 5QR heard 2AZ and 2ML. After calling in vain for some time, 5QR contacted 2QQ on 7 Mc. who quickly passed on the information to 2NO, and the VK2 gang were thus on the alert for signals from VK5. The following day the band was again open. Here in Adelaide, 5KZ and 5QR were conducting portable tests with 5GF when weak signals from

Continued on Page 22

## FEDERAL QSL BUREAU

The QSL Manager got a large-sized thrill recently when opening up a letter out tumbled a wad of fifty bank notes. The thrill however was short-lived as closer scrutiny revealed that the notes were on the Central Bank of China and dated 1930, and were of the five dollar variety. Turning over the reverse side of the note showed that an enterprising bunch of W Hams running W0MCF/C1 had come by a large quantity of the valueless currency and overprinted the notes for use as QSL cards. Quite a novel idea and worthy of the Naval Hams that thought it up.

Another surprise was a card turning up from W8LHH confirming a QSO with the writer in 1938!!! W8LHH apologies for being late with the card.

Circulars have been received from a body styling itself American QSL Bureau, Box 7073, Roseville Station, Newark 7, N.J., U.S.A., offering QSL facilities in the U.S.A. This body did not offer anything that is not already existing with the A.R.R.L. QSL Service so the offer was ignored. A letter to hand from the Assistant Secretary of the A.R.R.L. exhorts QSL Managers to disregard any circulars from the new body.

Another one for the stamp collectors—PY1AJ, Joao E Do Lago, Rua Sao Clemente 103-C, XXV, Rio De Janeiro, Brazil.

Bud Barnard, WINSS, 3rd, 126 High Street, Bristol, Conn., U.S.A., desires me to publish his thanks to all stations who contacted him while he operated WINSS/K6 and to state that he will QSL all contacts on his return to Hawaii. Unfortunately Bud left all his cards packed up at Hawaii and so can do nil until his return. Bud's heart's desire is to visit VK one day. Here's hoping too, Bud.

The S.O.S. put over the W.I.A. session on 7 Mc. for VK3 Hams to call or write for their cards and thus clear the Bureau congestion caused through the heavy QSL traffic of November and December and the abandonment of the monthly meeting of the VK3 Division, bore fruit, but the congestion is still heavy and any Ham expecting cards would help a lot by collecting them either personally or by mail.

From VK3YL comes some interesting dope on YP1AA whom she contacted. YP1AA is on a ship in the Black Sea, and HZ1AB is on the edge of the Persian Gulf. The latter station runs six operators and is using a Collins transmitter with 10 frequencies that can be dialled, and 400 watts to a pair of 813s. Antenna used is a vertical 80 foot high. Thanks Austine.

The correct QSL address for Porto Rico is:—K4KD, Box 1061, San Juan, Porto Rico. This information comes from KP4CC, Juan Castanera, who requests me tell the boys that anyone who has not received a card from him, to please write him and ask for it as he has his logs back to 1939.

PK6HA, Lt. A. Hagers, N.E.I. Air Force, Biak, Neth. East Indies, writes with a bitter pen regarding the QSL propensities of VK stations in general. To the time of writing, 28/12/46, PK6HA worked and QSLd 142 VK stations. Up to that time he had received 27 cards in return. He encloses a list of the VK stations who have not QSLd but in the interests of space it is easier to list the stations who have. They are VK2: ADE, ACX, AKX, DI, DA, PV, AML, AHR, DG, OL, VN; VK3: CN, CZ, DK, JA, MC, NM, OP, UM, UP, XK; VK4: DO, OS, RF; VK5JM; VK6: AS, RF. Now what about it all you chaps who have QSOd PK6HA and whose call signs are not in the above list. As Lt. Hagers is a subscriber to "Amateur Radio" I would like him to let me know if this

## CRYSTAL CLEAR

# "STYLON" (Etholex Polystyrene)

Which has the Dielectric Strength of High Grade Mica, the Low Loss Factor of Fused Quartz, Zero Moisture Absorption, Insulation Resistance of  $10^{17}$ — $10^{19}$  ohms per centimetre is the logical insulation for Radio Transmitters, Receivers, X-Ray Equipment and H.F. Heating Apparatus.

Stylon is the best insulation for ANY application where Electrical Efficiency is Essential.

STYLON SHEETS AND RODS ARE AVAILABLE FROM—

Queensland	N.S.W.	Victoria	S.A.	W.A.
Mica and Insulating Supplies Co. Pty. Ltd.	Mica and Insulating Supplies Co. Pty. Ltd. Jefferies Pty. Ltd.	Mica and Insulating Supplies Co. Pty. Ltd. Menzies Electrical Pty. Ltd.	Mica and Insulating Supplies Co. Pty. Ltd.	Carlyle & Co. Pty. Ltd.

**ETHOLEX PLASTICS, 108 Chapel Street, S.I., Melbourne, Anst.**

par produces results, otherwise the list of non-QSLers will have to be published.

A pleasurable letter was received this week from a VK3 station who had heard that the writer was relinquishing the post of VK3 QSL Manager. Although one derives satisfaction from seeing an idea take root and grow during the years and the knowledge that a show is running efficiently, it certainly is nice to hear it from someone else. Thanks a lot Geoff.

It is unlikely that the appointment of a successor to VK3RJ as VK3 QSL Manager will be finalised in time to appear in this issue of "Amateur Radio." Details of the change will, however, appear in the next issue. Until the change is notified the address of the VK3 Bureau remains at 23 Landale Street, Box Hill, E.11, Vic. In any case VK3RJ will continue as Federal QSL Manager.

The newly appointed Membership Secretary for VK3 is George Manning (VK3XJ) and all enquiries re membership in the VK3 Division should be addressed to George.

The VK3 QSL Manager will be on leave from 27th

**PRIZE FOR W.A.S. CERTIFICATE**

The amateur whose design for a W.A.S. 50 Mc. and above certificate is accepted, will receive a prize to be announced later. Closing date is 31st March in Melbourne. Address your entries to: The Federal Executive, Box 2611W Melbourne. The judging will be done by the Federal Convention in early April.

Let us see what the artistic ham can produce!

**LOW DRIFT CRYSTALS  
FOR  
AMATEUR BANDS**

ACCURACY 0.02% of STATED FREQUENCY  
3.5 M/C and 7 M/C.

Unmounted . . . . . £2 0 0

Mounted . . . . . £2 10 0

12.5 and 14 M/C FUNDAMENTAL CRYSTALS—LOW DRIFT—MOUNTED ONLY . . . . . £5 0 0

SPOT FREQUENCY CRYSTALS—PRICES ON APPLICATION.

REGRINDS . . . . . £1 0 0

THESE PRICES DO NOT INCLUDE SALES TAX.

**MAXWELL HOWDEN, VK3BQ**  
15 CLAREMONT CRES., CANTERBURY, E.7

January to 11th February and this time intends visiting the Blackwood district on the trail of the yellow metal. QSL correspondence during this period will suffer some delay.

**INTERNATIONAL AMATEUR  
FREQUENCY ALLOCATIONS**

**AUSTRALIA**

- 3500-3800 Kc.
- 7000-7200 Kc.
- 14000-14400 Kc.
- 28000-30000 Kc.
- 50-54 Mc.
- 166-170 Mc.
- 1345-1425 Mc.
- 2500-2700 Mc.
- 5250-5650 Mc.
- 10000-10500 Mc.

Type A0 emission may be used on all bands from 166 Mc. upwards.

**AMERICA**

- 3500-4000 Kc. A1.
  - 3850-4000 Kc. A3.
  - 7000-7300 Kc. A1.
  - 14000-14400 Kc. A1.
  - 14200-14300 Kc. A3.
  - 27185-27445 Kc. A0, A1, A2, A3, A4, FM.
  - 28000-29700 Kc. A1.
  - 28500-29700 Kc. A3.
  - 29000-29700 Kc. FM.
  - 50-54 Mc. A1, A2, A3, A4.
  - 52.5-54 Mc. FM.
  - 235-240 Mc. A0, A1, A2, A3, A4, FM.
  - 420-430 Mc. A0, A1, A2, A3, A4, FM.
  - 1215-1295 Mc. A0, A1, A2, A3, A4, A5, FM, Pulse
  - 2300-2450 Mc. A0, A1, A2, A3, A4, A5, FM, Pulse
  - 3300-3500 Mc. A0, A1, A2, A3, A4, A5, FM, Pulse
  - 5650-5850 Mc. A0, A1, A2, A3, A4, A5, FM, Pulse
  - 10000-10500 Mc. A0, A1, A2, A3, A4, A5, FM, Pulse
  - 21000-22000 Mc. A0, A1, A2, A3, A4, A5, FM, Pulse
  - All above 30000 Mc. A0, A1, A2, A3, A4, A5, FM, Pulse.
- Peak antenna power must not exceed 50 watts.  
A0—Unmodulated carrier; A1—CW; A2—MCW; A3—AM Telephony; A4—Facsimile; A5—Television; FM—Frequency Modulation.

**NETHERLANDS**

- 3500-3900 Kc. CW.
- 3600-4000 Kc. Telephony.
- 7000-7300 Kc. CW.
- 7150-7300 Kc. Telephony.
- 14000-14400 Kc. CW.
- 14100-14400 Kc. Telephony.
- 28000-30000 Kc. CW.
- 28200-28500 Kc. Telephony other than USA.
- 28500-29700 Kc. USA Telephony.
- 29000-29700 Kc. FM Telephony.
- 58.5-60 Mc. CW.
- 58.75-59 Mc. DX Telephony.
- 59-60 Mc. Local Telephony.

The V.E.R.O.N. proposes that these divisions of the bands be considered for adoption by member societies of the I.A.R.U. The V.E.R.O.N. are requesting their Government to change the 58.5-60 Mc. assignment to 50-54 Mc.

**FRANCE**

3500-3625 Kc. 50 watts.  
7000-7200 Kc. 50 watts.  
14000-14400 Kc. 50 watts.  
28000-30000 Kc. 100 watts.  
58500-60000 Kc. 100 watts.

**SWEDEN**

3500-3635 Kc. CW.  
3685-3950 Kc. Phone and CW.  
7000-7100 Kc. CW.  
7100-7300 Kc. Phone and CW.  
14000-14100 Kc. CW.  
14100-14250 Kc. Phone and CW.  
14250-14400 Kc. CW.  
28000-28200 Kc. CW.  
28200-30000 Kc. Phone and CW.  
58.5-60 Mc.  
112-120 Mc.  
235-240 Mc.  
420-430 Mc.

The maximum power for all bands is 50 watts.

**NEW ZEALAND**

3500-3960 Kc. CW and AM Phone.  
7000-7300 Kc. CW (H.F. Permit Holders).  
14000-14400 Kc. CW (H.F. Permit Holders).  
14200-14800 Kc. AM Phone (H.F. Permit Holders).  
28000-30000 Kc. CW, AM Phone (H.F. Permit Holders).  
50-54 Mc. CW, AM Phone (for general use).  
52.5-54 Mc. FM, PM Phone (for general use).  
168-170 Mc. CW, AM, FM, PM Phone (H.F. Permit).  
420-450 Mc. CW, AM, FM, PM Phone (H.F. Permit).  
1345-1425 Mc. CW, AM, FM, PM Phone (H.F. Permit).

**INSULATORS**

Large strain type, egg shaped . . . 16/6 dozen

**INSULATORS**

Small Egg Insulators . . . . . 3/6 dozen

**INSULATORS**

Standoff Insulators, 1" high with bolt 1/6 ea.

Standoff Insulators, 1" high with banana socket . . . . . 1/8 ea.

Miniature Tubes for high frequencies.

6C4, 25/-      6AG5, 30/-      6J6, 32/6

Prices include sales tax, but not freight.

**AUSTRYL RADIO SUPPLIES**

T. D. HOGAN (VK3HX)

127 Oakleigh Road, CARNEGIE, S.E.9

Telephone: UM 1732

**DIVISIONAL NOTES.****NEW SOUTH WALES**

Secretary: Peter H. Adams, VK2JX,  
Box 1734 G.P.O. Sydney.

Meeting Place: Science House, Gloucester and Essex Streets.

Meeting Night: Fourth Friday of each month.

The December meeting was well attended, over 100 members and visitors being present. The proposed arrangements for the Field Day, to be held at Wyong, 26th January, were discussed and it was decided to operate the hidden transmitter on 7 Mc., leaving the 166 Mc. gear until members had gained more experience on this band.

Don Knock, VK2NO, gave a resume of recent activity on the 50 Mc. band culminating in a number of two-way Interstate QSOs and in subsequent discussion it was revealed that ZL1KJ had heard VK2, 3, 4 and 5 signals. It was proposed to ask Federal Executive to award a trophy for the first Interstate 50 Mc. QSO as decided at the last Federal Convention.

At the conclusion of general business a number of excellent sound films dealing with radar were shown. These were special instructional films used in the R.A.A.F. during the war and members gained a clear picture of the manner in which all types of radar equipment actually functioned.

Morrie Meyers (2VN), who went overseas on a business trip for Qantas towards the end of November, has been stationed for the past six weeks in Los Angeles. He has had numerous contacts with the local boys, operating from K6EBG and W6FUF, and has kept a regular sked with 2DA on 14 Mc. every Wednesday morning at 0100 hours E.A.S.T. Morrie usually stays the night at W6EBG's place, so he goes on the air just before breakfast, but poor old Harry must lose a lot of sleep. Over the Christmas Holidays Morrie made a trip to Mexico, but, although he asked the boys to look for him from XE1AM, he must have found the scenery—or the señoritas—more interesting than Ham Radio.

**VICTORIA**

Secretary: A. B. D. EVANS, VK3VQ,  
Box 2611 W G.P.O., Melbourne.

Meeting Night: First Wednesday of each Month.

Meeting Place: Radio School, Melbourne Technical College.

**WESTERN ZONE**

This is the first report of the news from this Zone since our convention when 3HG was elected notes correspondent. 3HG would appreciate a call on 7 or 3.5 Mc. occasionally to gather notes and doings of the gang, so please look out for him on Sundays or week days around midday.

Most of the Zone stations are at present engaged in experimenting with mobile equipment for use in bush fire emergency work; 3YN, 3TW, 3AMP and 3QC being very active in this work. Of the Ham activity, most stations seem to work on 7 Mc. phone, with the DX stations keeping an ear on 14 and 28 Mc.

Our DX C.C. station, 3KX, has already passed the century post-war and is now waiting for conditions to improve to raise his score still further. — . . . — Your scribe is also nearing the coveted century, but finding conditions against him at present. — . . . — 3MC and 3NC also doing well with the DX, the latter using only 6

Continued on Page 16

**CONTESTS**

The A.R.R.L. will be conducting a DX contest in February and March. Unfortunately full details are not available, but it is understood that the details of the contest will appear in the January issue of QST, which issue is not to hand at the time of going to press.

However a few details are to hand. The first half of the contest will commence on February 15 at 0001 GMT and ends on 16th February at 2359 GMT (48 hours less 2 minutes). The second half commences 15th March and ends on 16th March. Times are the same as for the first half. These are the details for the CW section. The telephony section commences with the first half on 22nd February and ends on 23rd February. The second half commences 22nd March and ends on 23rd March. Times for both periods are 0001 GMT until 2359 GMT.



In April the B.E.R.U. will conduct a contest which will be divided into three sections:—

- (a) Senior (high power) transmitting contest.
- (b) Junior (low power) transmitting contest.
- (c) Reception contest.

The senior section will commence at 0001 GMT, Saturday, 12th April, and continue until 2400 GMT, Tuesday, 15th April, 1947, but only 30 hours operation will be permitted from the total of 96 allowed. The selection of the periods totalling the 30 hours is left to the individual operator. Input power of that specified on the competitor's licence, and in no case more than 150 watts.

The junior section will commence at 0001 GMT, Thursday, 17th April, and ends at 2400 GMT, Sunday, 20th April, 1947. The same conditions apply as for the senior section except that the input must not exceed 25 watts.

Entrants must be financial members of the Wireless Institute of Australia, and logs must be submitted to the sponsors of the contest on the special forms supplied by the B.E.R.U. These forms may be obtained from the Australian contest manager, Mr. R. Cunningham, VK3ML, Box 2611W, G.P.O., Melbourne.



**ENGLISH AMATEURS**

Permission has been granted for British Amateurs to use a new amateur band between the frequency limits of 2300-2450 Mcs. Maximum power must not exceed 25 watts. Frequency modulation may be used on this new band. Pulse operation is not permitted.

The Type BT Resistor, with its many superior features and special practical advantages, is the final result of more than twenty-three years of intensive research and development work on the part of IRC engineers.

The time-tried Metallized filament principle is retained, but the ingenious construction, firmly based upon sound engineering principles, ensures lower operating temperatures with proportionately higher wattage dissipation in a conveniently small, sturdy light weight, fully insulated unit with an exceptionally low noise level.

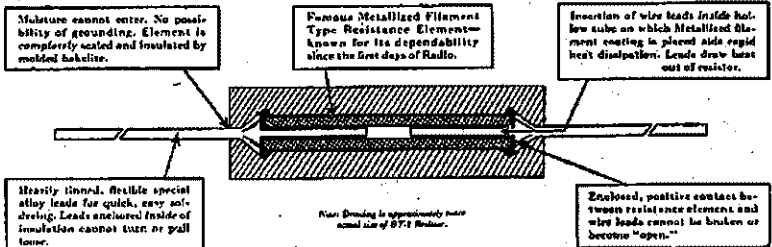

Available in  $\frac{1}{2}$  w., 1 w., and 2 w. sizes  
Sole Agents for Australia:

**Wm. J. McLELLAN & CO.**  
BRADBURY HOUSE, 55 YORK ST., SYDNEY • PHONE BW2385

**DIVISIONAL NOTES**

(Continued from Page 14)

watts. ——— 3JA should take out a dealers' licence, as he has been buying and selling a lot of gear lately. ——— 3TA now on full power after using an Army 108 to keep in touch with the Zone members. ——— 3GN is very quiet lately. ——— 3JX is all set to go on 50 Mc. ——— An old timer now in this Zone is Mart Chaffer, ex-3XF, now 3MH. Still another old timer to be bitten again is 3SA, who will be on soon. ——— 3II, 3NK, 3ZU, 3EQ and 3AGB all have good phone on 7 Mc. ——— 3FA not on much due to lack of time, but was heard on 14 Mc. lately with a good signal. ——— 3DX is co-operating with a mobile rig for fire work. ——— 3XI was on for a while but has not been heard of late. ——— Let's have your news before the 12th of each month, gang.

**VICTORIAN BUSH FIRE COMMUNICATIONS**

An account of some experiments conducted and tests made in Bush Fire Regions 4 and 5 (Hamilton Area) by VK3TW and VK3YN.

It was realised at the outset that approaching the bush fire radio control matter in a haphazard way would inevitably reflect on the future success or otherwise of what may well become one of the most advanced developments in bush fire control.

Firstly a system had to be evolved and procedure adopted whereby radio could be employed in the most effective manner and with the least possibility of creating a position of utter chaos. It was realised that time was the essence of the contract this season and therefore the following scheme was evolved and put into operation.

We must first realise that fires of the type experienced in the Western District can quite easily obtain a front of over three miles, and travel at a speed of up to ten

miles per hour, which, in itself, makes mobility a primary consideration. Each brigade will be fighting its own section of the fire as a unit and under its own Captain, who, in turn, would operate under the control of the central fire officer, located at the base transmitter together with his auxiliary fire fighting units. Each brigade will have at its disposal a small portable transmitter and receiver with a range sufficient to remain in contact with the forward control unit, in this case a mobile 20 watt transmitter, which in turn will be in communication with the base station. Every home and many cars have broadcast receivers and to take advantage of this set up it was resolved to enlist the aid of the local commercial station who would broadcast details of the fire and issue warnings to threatened areas at the request of the responsible fire officer, who has an intimate knowledge of the fire via the radio communication system.

One of the main technical problems was the maintaining of communication between the mobile forward unit and the base station over an area in excess of 2,500 square miles. It was thought that the low frequency end of the 3.5 Mc. band was as good as any available to amateurs, especially as the allocation of more suitable frequencies in the 2.5 Mc. region would take valuable time to procure and further it is a relatively simple matter to calculate the increase in field strength which would be obtained at lower frequencies from the measurements taken.

Preliminary calculations showed that, frequencies in the 3.5 Mc. region, a power of approximately 14 watts would be required to give satisfactory reception at the maximum distance of 60 miles, using a short vertical antenna for transmission. A transmitter was therefore constructed capable of this power output and field strength measurements were taken along all main roads radiating from the location of the base station to the boundary of the bush fire region concerned.

**A**  
**B**  
**A**  
**C**

**AUSTRALIA'S**  
**BEST**  
**AMPLIFIER**  
**COMPONENTS**

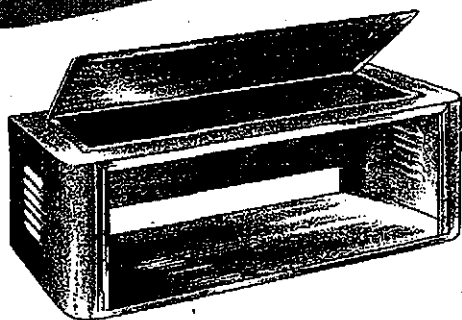

**ABAC**  
**Standard**  
**Receiver**

Or Instrument  
Case. Takes 19 x  
8½ panel with  
clear panel space  
17½ x 7½. Depth  
of case 11 inches.

MANUFACTURED BY

**TRIMAX TRANSFORMERS**

29-35 FLEMINGTON ROAD  
NTH. MELBOURNE, VIC.  
(Division of Cliff & Bunting  
Pty. Ltd)

# BRIGHT STAR RADIO

★ **VK 3UH** ★

1839 LOWER MALVERN ROAD, GLEN IRIS, S.E.6., VICTORIA

Phone: UL 5510.



As illustrated 40 and 80 metre AT or BT cut accuracy .02% of your specified frequency, £2/12/6.

Large unmounted 80 and 40 metre . . . . £2/0/0.

20 metre, zero drift . . . . . £5/0/0

Plug-in Holders, 5 pin . . . . 7/6 and 12/6

Crystals Reground . . . . . £1/0/0 each

A limited number of the world famous Taylor Transmitting Tubes will shortly be available in the following types:—T20, T21, T40, TZ20, TZ40, T55, TB35, 866 Junior.

Data Sheets and information free on request.

Place your order now to avoid disappointment.

The results were very encouraging, and it was found possible to maintain mobile contact at a distance of 30 miles on roads entirely surrounded by mountain ranges in the Grampians. Owing to the high noise level at the base station, it was found desirable to increase the field strength and as power was fixed the efficiency of the antenna at the mobile station was increased by centre loading. When this was done the range was extended to 55 miles through the poorest country in the area. Tests with ex army equipment in this type of country proved them to have no practical use and plans are well in hand for the modification of sets type FS6 and 108 to render them serviceable for brigade to mobile communication.

A great deal of development work is yet to be done, although sufficient has been accomplished, in collaboration with the regional fire officer (Mr. K. Eales), to provide a workable system for this summer and a nucleus for expansion in preparation for the 1948 season. A surprising feature of the tests was the close adherence of the practical results obtained to the calculated results obtained from wave propagation formulae.

Since the writing of the above, the communications net in the Hamilton area have attended two serious fires and in both cases were at the scene of the fire before the brigades arrived and the results proved conclusively the value of radio communications under such circumstances. Hams concerned in this case were VK3MC, VK3HG, VK3TW and VK3YN.

In other areas there is considerable activity. VK3QC has installed a mobile on the brigade truck at Terang and operated another mobile from his own panel van. One fire has been attended which was caused by lightning, and in spite of serious QRN, 100% communication was obtained from the scene of the fire to the town.

VK3AMP has spent considerable time in building and converting ex-service gear for use in bush fire commun-

ications. Using a rebuilt 19 set with plate modulation from a class B 6N7 and a 12 foot whip antenna he did a tour starting from Colac through Cressy, Lismore, Camperdown and back to Colac and in no case did his signal strength fall below R7.

VK3GN at Ararat has also been busy and had built a complete transmitter for VL3KJ. VK3TA at Horsham has three mobile units ready for any emergency, and VK3BI at Ballarat in conjunction with VK3IV are also ready with a 7 Mc. outfit and are converting a 109. VK3JA is acting as a sub-base for VK3QC, VK3EQ at Warrnambool has established a base station and VK3ZU is acting as mobile.

## CONTENTS OF TEXT BOOK AND INSTRUMENT LIBRARIES

In our last bulletin we told you how to borrow books and instruments. In this issue we propose to give you some idea what you may borrow, and what instruments are available for use in laboratory under supervision.

### Technical Book and Publication Library

Contains Magazines such as Amateur Radio, QST, Radio and Wireless World. Text Books: Admiralty Handbook, Radiotron Designers' Handbook, A.R.R.L. Handbook, Fundamentals of Radio, by Ramsay; Frequency Modulation, by Hund; Hyper and U.H.F. Engineering, by Sarbacher and Edson; Radio Receiver Design, by Sturley; Radio Receiving Tubes, by Moyer and Wostrel; Radio Operating Questions and Answers, by Nilsen and Hornung; Automatic Frequency Control, by Rider; Basic Radio, by J. Barton Hoag; Time Bases, by O. S. Puckle; Fundamentals of Radio, by Terman; Radio Laboratory Handbook, by Scroggie. New books and magazines are being constantly added.

Confidence is the  
companion of success!

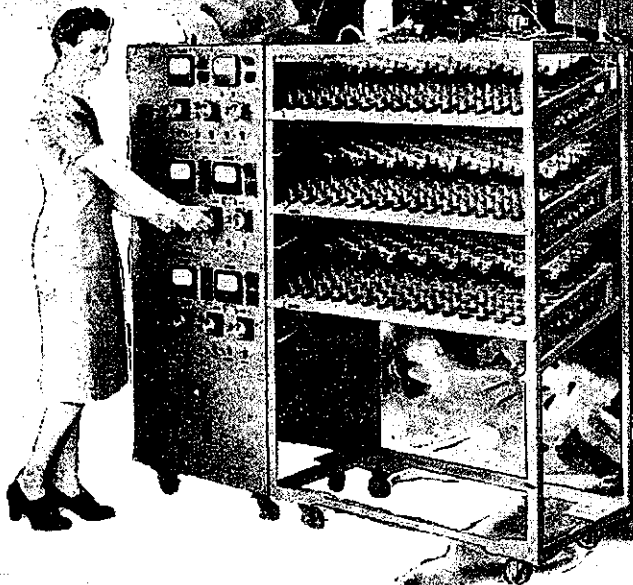

Completed valves undergoing final acceptance tests.

Yesterday-Modern Valve making equipment in the hands of skilled operators at the Valve Works of Amalgamated Wireless Valve Company Pty. Ltd. met the nation's exacting wartime needs.

Today - this same machinery is being utilised to satisfy the expanding demand by Radio Listeners for the world's standard valve—



AMALGAMATED WIRELESS VALVE COMPANY  
PTY. LTD.  
47 YORK STREET, SYDNEY, N.S.W.

**Radiotron**  
V A L V E S  
MADE IN AUSTRALIA



**Instrument Library.**

Category A.—Weston Galvanometer, Bendix Type Frequency Meter, Standard Resistors, Philoscope, V.H.F. Calibrator Set 230-155 Mc., GR Audio Output Meter, and Double Beam Cossor C.R.O. now on order and expected daily.

Category B.—Weston R.F. Ammeters and Milliammeters, Multi-Range D.C. Voltmeters, High Voltage D.C. Meters, Micro-Ammeters.

Category C.—Weston A.C., D.C. Volt and Ammeters, Milliammeters, GR Absorption Wavemeter for 50-54 Mc. band.

The T.A.C. is constantly seeking advice of members as to what items they consider should be included in both Book and Instrument Libraries. Pass YOUR suggestion along at the first opportunity.

**QUEENSLAND**

Secretary: C. Marley, VK4CJ,  
Box 638 J. G.P.O., Brisbane.

Meeting Place: State Service Building, Elizabeth St., City.

Meeting Night: First Friday of each month.

For all the information we have this month it is hardly worth while putting in an appearance at all. For the next month it should be possible to give some idea as to the date of our annual meeting and of course, with it, the election of office-bearers for the following year.

The 14 and 28 Mc. bands seem to have packed up in Brisbane, at least for the time being, although by sheer determination 4AP succeeded in grabbing off a couple of Africans on 28 Mc. and so got his post-war W.A.C. The grape vine passes along the information that 4CU has been holidaying at Redcliffe, and we trust enjoying himself.

Whilst in Bundaberg recently a visit was paid to the locals and incidentally the hospitality turned on was really appreciated. 4PG is mentioned in the V.H.F. Notes, so omitting Arthur, we find 4BJ and 4UX very active on 14 and 7 Mc. and also very interested in 50 Mc. Both have new rigs in course of construction and they really look good, and it is to be hoped they work as well as they should.

So, until next month when we expect to have a little more to talk about, it's 73 es CUL.

**SOUTH AUSTRALIA**

Secretary: E. A. Barbier, VK5MD,  
Box 1234 K, G.P.O., Adelaide.

Meeting Place: 17 Waymouth Street, Adelaide.

Meeting Night: Second Tuesday of each month.

A record attendance of 130 members was reported at the monthly general meeting of the W.I.A. last Tuesday. Among the visitors were Messrs. B. J. Grafton, A. F. Cunningham, E. Wood, T. C. Hosking, B. McNamara and Ray Smith (ex-3RY). Mr. E. J. Cawthron (5JE) gave an interesting talk on "Amateur Radio whilst a P.O.W." It was announced that the total membership is now 282.

Ted Cawthron gave probably the most entertaining lecture of all time. Those who knew his form were prepared for some humour but nobody expected such a riot as Ted dished up. There were occasions when he could not continue for some time owing to the audience being convulsed with laughter and unfortunately no attempts of mine would be capable of putting on paper the humorous stories with which Ted secured his laughs. There is no doubt that if Ben Fuller or J. C. Williamson ever hear of Ted the P.M.G.'s Department will lose one of its

staff. The gem of the night will bear repeating and is a fair sample of the rest.

The "Nips" apparently had no qualms about printing highly coloured stories of the valour of their airmen, and in black and white stated that one "Nip" airman, finding himself out of ammunition and sighting a cargo ship below, simply flew upside down, drew his sword, and flying past the bridge, cut off the captain's head. Yes, "fair dinkum!" Need I say more.

Mr. Merv. Brown (5MB), in proposing a vote of thanks summed up the position when he said that some lecturers in America were in the habit of "stacking" the audience to applaud or laugh in the right places, but Mr. Cawthron need never bother to do this as the audience was with him to a man from the start. Speaking seriously, it is realised that although Ted had glossed over his personal actions and the undoubted risks which he ran in attempting to secure news for the morale of the P.O.Ws., undoubtedly his training as an amateur had assisted in no small manner to help him over the bad times whilst a P.O.W.

The W.I.A. representation on the Advisory Council has been increased to four members and nominations have been called from members to secure eight Hams from whom the P.M.G. will choose the required four representatives. This new method of nominating for the Advisory Council has a lot to recommend it and will go a long way toward removing that peculiar objection by some Hams toward the Advisory Council.

W.I.A. interest is high in amateur circles in VK5. The last meeting (14th Jan.) was so crowded that many Hams were forced to seat themselves upon the floor. With the proposed formation of an U.H.F. section with its own meeting night, etc., the W.I.A. should be established in an unshakable position. Leaving myself out, I say without hesitation that a good deal of this is due to the present Council who have put an enormous amount of energy

**GLO-RAD****RECOMMENDS . . . . .**

Use of "Clipper" circuits as means of securing greatest results with least waste of modulating energy.

Limited number of suitable Input, Interstage, and Output Transformers are offered to Hams.

**PRICE 20/- plus Sales Tax.**

Please add postage and exchange to country orders.

Mail your order NOW . . . . .

**Glo-Rad Engineering Services**

Box 2147T G.P.O., Melbourne

Phone: WX 3440

and hard work in the W.I.A. affairs over the past eighteen months or so.

Should the P.M.G. Department ever abolish the Class "A" and "B" licence, 5PS, 5MD and 5IV will miss the little game of ball tossing which regularly takes place at every meeting. 5PS usually tosses the ball to the chairman (5IV) by asking if any news is available re the abolition of "A" and "B." 5IV tosses the ball to 5MD who thereupon usually tosses it back to 5PS by reading a letter from F.H.Q. A very pretty little game and one that has never failed to get a laugh from the members.

Received news from VK3XU (ex-5XU) and was pleased to know that Gordon is well and still an enthusiastic Ham. All the VK5 boys send regards but why not come down to 14 Mc. OM and we can deliver the regards personally.

This business of being correspondent to the local paper and also the Magazine has its limitations. When anybody discusses the weather or how many eggs their favourite hen is laying they preface the remarks by saying "now this is not for publication" or else "keep that pencil in your pocket." Several Hams have said "good-night" in a suspiciously frigid manner lately, and I am beginning to find newsgathering an arduous job. Nevertheless Walter Winchel, Don Iddon and Quentin Reynolds are never deterred by anything like this, so who am I to slack up, ahem! Anyway fellows thanks for your help in the past and keep up the good work in the future. If you get a "flash" 5DN will always find me.

G3AVK (Mr. Dave Robertson, ex-VK5RN) has been heard on 14 and 28 Mc. His frequency on 14 Mc. is 14140. Mr. Robertson is at the Birmingham University under Professor M. E. Oliphant in connection with Atomic Physics.

At the last meeting of the Advisory Council the Chairman (Mr. P. Traynor) commented on the present good

standard of operating on the various amateur frequencies. Aside from a few unnecessary long CQs and a little superfluous conversation at times, the post-war Ham is definitely regulation conscious.

The news that Prof. Sir Kerr Grant had figured in the New Year Honors List was well received in amateur circles. His personal interest and ready assistance in radio matters has always been appreciated.

It has been suggested to Council that VK5 amateurs may care to send a food parcel to their opposite call sign in England. For example VK5ABC would send a parcel to G5ABC. Members are to be circularised regarding this matter.

The Technical Committee of the W.I.A. reports a busy and successful year. The members are VK5MO (chairman), 5MB, 5DA, 5MF, and 5DW. The Committee is available for advice and instruction on any technical matter, and amateurs are cordially invited to seek their advice c/o Hon. Secretary.

## TASMANIA

Secretary: J. Brown, VK7BJ,

12 Thirza Street, New Town. Phone W 1328.

Meeting place, Photographic Society's Rooms,  
162 Liverpool Street, Hobart.

Meeting Night: First Wednesday of each month.

The December meeting of the Council took place at the residence of 7CT, 385 Elizabeth Street, North Hobart, at 8 p.m. on the 20th. Present were 7LJ in the chair, 7BJ, 7CJ, 7CT, 7RF, and 7PA. Apology from 7CW. Correspondence, inward and outward, read and confirmed. Secretary reported the regrettable need of removing several names from the register, owing to their failure to make themselves financial within the prescribed time.

*You cannot afford to omit PRICE'S RADIO  
from your buying list*

● VALVES

● METERS

● CRYSTALS

● CONDENSERS

And all those other parts that go to make a successful "Ham" transmitter and receiver, are now available, or on their way from overseas.

PLUS AN EFFICIENT TECHNICAL SERVICE — VK 2ZH IS AVAILABLE TO HELP YOU  
WITH YOUR PROBLEMS.

**PRICE'S RADIO** 5 & 6 ANGEL PLACE  
SYDNEY, N.S.W.

In previous times this rule had not been rigidly enforced but in this new era it is intended to carry it out. Time has been extended to give every opportunity, and persons who really do desire to remain members must make some effort to keep financial, even by paying up in instalments if found more convenient. Due notice is given and the Secretary has an abundance of work without devoting time to those who are not interested enough to look after their side of the deal.

Two applications for Associate Membership were received and recommended for confirmation at the next general meeting. The pleasing results of the Field Day were discussed and hopes expressed for even a better one in January, 1947. After much ear-bashing over a goodly supply of supper, dispensed by Mrs. 7CT, the evening—a sultry one too—came to a close with thanks being extended to Mrs. Connor for the attention given.

General meeting, 8 p.m., 8/1/47, one week late owing to the New Year's Day holiday being the first Wednesday. Present were 7CT in chair, 7BJ, 7AH, 7DW, 7YY, 7DH, 7CJ, 7VJ, 7AC, 7RF, 7TR, 7GR, 7OM, and Messrs. Koglin, Tucker, R. Fulton, K. Milne, Lipscombe, and R. Allenby. Visitors: L. Edwards, Brown, Watson (2). Apologies from 7LJ, 7CW, 7PA, 7AL, and 7ML. In the absence of President and the two Vice-Presidents, the remaining two Councillors spun the coin in traditional fashion and 7CT, being the winner, was duly installed and thoroughly upheld the traditions set by his predecessors. The holiday spirit must have pervaded the secretarial precincts as no correspondence was reported either way. Two new Associate Members in the persons of R. Fulton and K. Milne were accepted. Advisory Committee members were re-elected for a further 12 months, they are 7LL, 7GJ and 7AC.

The next Field Day was set down for 19/1/47 on same frequency and conditions as previously. Transmitter to be under the control of 7LL.

Bert Russell did the honors for the evening by showing a series of "Talkie" Shorts, much to the enjoyment of all and a hearty vote of thanks to him completed this first meeting for 1947.

7YY reports contact with 7LZ of Launceston, who has suggested a W.I.A. meeting in that City would do much to stimulate interest there, a suggestion worthy of earnest consideration too. 7AB has volunteered to transport a car load from the Coast and several cars are offering from Hobart. Consideration is being given to carrying out this trip in February, but no exact date made as yet until further information can be had from the North. 7YY and 7LZ have arranged a schedule on 3.5 Mc. and suggest a little more use of this band would be worthwhile in keeping the North and South in closer touch, other bands are of little use for this purpose. 7YY's sky-wire is nothing more than 15 feet of wire stretched along a balcony for 3.5 Mc. and he seems quite proud of its performance too.

7AL, holidaying on East Coast with a portable on 14 and 7 Mc., says VKs 2, 3, 4, 5 and 6 as well as ZLs 1 and 3 have been QSO'd, VK7s, as usual, not being heard. The ZLs romp in during the afternoons. He is powered with a Japanese souvenir, a 12 volt genemotor and has about 27 watts input. — — — 7CW still active on 50 Mc. and has been joined by 7GH and 7GR so we are on the way to producing a 50 Mc. gang—whose next!

On 11th December, 7CW heard 2NO and 2NT at 7.30 p.m. E.A.S.T. coming through up to S9 at times. Since then he has built a separate 50 Mc. rig and from 17th December to 25th December was putting 100 watts into a three element beam each evening from about 6.30 p.m. onwards with automatic keyer, CQ-VK7CW-6. He says had he been ready when 2NO changed over to hand keying for a call he feels sure they could have QSO'd satisfactorily as conditions were good. Since then he has been away on holidays. (Believe he has since contacted VK2—Editor.)

## CLEARING THE ETHER

(Continued from Page 4)

R.R. input and output jacks are mounted on left and right sides (rear) of unit respectively. Each consists of two projecting type jacks mounted on polystyrene base, and spaced  $\frac{1}{2}$ -in. apart in order to receive standard twin plug, for use with twisted pair feeder.

The final feature is polarised jack for H.T. supply. This circuit must be insulated to D.C. plus modulation voltage, and the polarised jack enables us to do this and at the same time retain flexibility of "plug-in" facility.

**Mechanical Aspects of Coil Units for Second Stage.**—Input and output units are identical, and Figure 12 conveys sufficient information to enable average reader to grasp idea without further explanation here, except to note that the formers for low frequency are of bakelite tubing; but higher frequency coils are self supporting. Robust design of polystyrene base makes this a push over. In each case link is wound over the centre of tank coil. Where harmonic emissions are noticeable, a faraday shield should be interposed between anode and link coils; however this subject will receive further consideration when dealing with antenna tuning unit.

**Operation of Second Stage.**—In operation this stage may be used as:—

- (a) Final stage for either C.W. or Phone operation.
- (b) Driver for higher power or higher frequency unit.

In practice that amount of drive applied to this stage by the first stage is controlled by varying voltage applied to screen grid of first 807 by means of potential divider. Sometimes it is desirable to load the first stage heavily to prevent spurious operation, in this case, swamping resistor connected across link or grid input circuit of second stage will serve the purpose. This artificial load may, when applied to the link circuit, take the form of carbon filament lamp. The carbon filament lamp is recommended because of its negative resistance, that is, if the driver output tends to increase, resistance of lamp will drop placing greater load on driver and thus compensating for rise in output or vice-versa.

**Harmonic Operation of Second Stage.**—In order to convert to push-push operation for frequency doubling it is only necessary to arrange the output coil unit so that plugs 1 and 5 are bridged to hot end of coil, and that cold end of coil is connected to plug 3. Under these conditions the two anodes are effectively connected together; furthermore, the two sections of tuning capacitor are shunted quadrupling the effective maximum capacity thereof. Naturally the link is situated at the cold end of the coil.

### Bugs, Bugs, Bugs.—

- (a) Spurious oscillation in screen grid/anode circuit, eliminated by interposing 50 ohm stopper resistor between screen grid of each tube and its associated by-pass condenser.
- (b) H.F. Parasitics.—Defeated by employing parasitic suppressor consisting of self supporting 8 turns coil wound over 100 ohm 1 watt carbon resistor installed in wiring at anode clip of each tube.
- (c) Second Harmonic Back Wave.—When excitation is removed from stage it tends to oscillate feebly at second harmonic, this condition can be eliminated by applying fixed bias to shift operating condition when unexcited.

## 50 AND UP

(Continued from Page 11)

2NO were heard. A constant watch was then kept and later VK2 signals increased to a maximum peak of S9. 5GF, using a transceiver on the Port River, heard the VK2s at excellent strength but was unable to make a contact. 5QR succeeded in contacting 2AZ for the first VK2-VK5 50 Mc. QSO. A few minutes later 5KZ also contacted 2AZ. The only other QSO that afternoon was between 2AHF and 5QR.

It was immediately apparent that C.C. transmitters were essential, as the modulated oscillators of 5RQ, 5GF, and 5NG could not make the grade with the superhets of the VK2s. Signals heard at good strength included 2NO, 2ML, 2WJ and 3ABA.

The band opened again on 6th January. Two more C.C. transmitters were on the air. 5RQ succeeded in working 2WJ, and 5RT was heard at good strength in VK2, but his receiving conditions were against him. 5QR succeeded in working 2AZ, 2WJ, 2LZ and 2LY with a part QSO with 2NO. Reception conditions were poor, as many radiating super-regens cluttered the band.

8th January at 8 a.m. was the next burst of activity. This time the VK4s came through. After vainly calling 4ZU for some time, 5QR eventually contacted 4HR for the first VK5-VK4 contact. This was shortly followed by a QSO between 4HR and 5GF who now has a 50 watt C.C. transmitter on the band. 4AW and 4CB were heard.

The latest Interstate contact occurred on 5th January at 11.15 a.m.!! 2AZ and 5QR were in contact for an hour with S9 signals both ends. That evening at approximately 9.30 p.m., 5QR heard 3IZ and 3DA at S9 calling CQ but all his vocal efforts into the microphone proved fruitless and the VK3s faded a few minutes later.

The active 50 Mc. C.C. transmitters at present are:— 5GL (50.91 Mc.), 5KO, 5GF, 5RT (52.2), 5QR (50.0), 5RQ (50.28), 5KZ, 5NG (52.4), 5GB (51.0).

## CORRESPONDENCE

Correspondents are requested to keep their letters short and to the point. The Editor reserves the right to delete anything he may think fit. The views expressed by correspondents are not necessarily those of the proprietors.

Editor "A.R."

Since my arrival up here I have had the chance to observe the activities of some amateurs operating from remote spots in this country who apparently imagine their signals are not under observation of the R.I.s, particularly on the 28 Mc. band.

Out-of-band operation, use of resonant filters, poor QRI and general sloppiness of operating are common tricks I have had the misfortune of hearing up here in Katherine.

Apart from the fact that these people are creating a poor impression amongst foreign stations, they represent a real menace to the serious DX chasers who are unfortunate enough to be caught by the blast of their hash.

Having had two QSOs spoilt this morning by a VK3 using a beautiful band-saw resonant filter, I developed sufficient steam to bash this out to you!

Yours faithfully,

N. G. ROBERTS, VK5NR.

## "RED LINE"

### AMATEUR TRANSMITTING GEAR

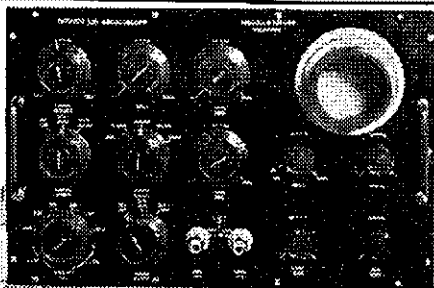

PRECISION IN DESIGN  
AND WORKMANSHIP



Technical Service,  
Wholesale and Manufacturers  
A. T. SWALES  
2 Coates Lane, Melbourne  
Cent. 4773.

Available from  
**SWALES & SWANN**  
and Leading Distributors in all States.

Trade Sales: Allen SWANN,  
157 Elizabeth Street, Melbourne.  
MU 6895 (3 lines)

## Low Voltage Soldering Irons

By A. HEYARD, ZL2UQ, From "Break In"

The urge to try out hook-ups is irresistible to anyone who has allowed the smell of burning resin core to enthral him. The Wogs say the same of the smell of Cairo, but that is only their idea. The writer, being no exception to the average run of hams, has spent off periods in trying out some ideas with a view to incorporation in the old Solon gave up the ghost. Couldn't get another and the ordinary "domestic" iron at hand was too big, too heavy, and too apt to burn and necessitate re-tinning at the wrong moment.

Browsing through a radio periodical, an advertisement for low-voltage irons was found, and the idea was born. Have used a home-made low-voltage iron ever since with marked success. Had a 75-watt core on hand, so decided to make up one or possibly two irons of 30-watt size. Here is the dope, which, it is hoped, may prove useful.

The bit was made of half-inch round copper about 3½-in. long, turned down to ¼-in. for half its length, and bored out to take the element at the wide end—5/16-in. hole 1½-in. deep. Quarter-inch end shaped to operator's idea of what the business end of an iron should look like. Two or three 5/16-in. mica discs square across the bottom of the element hole will take care of insulation there. The element is self-supporting. Found the easiest way to make this is to cut a nick in a short piece of copper tube of suitable diameter, pass one end of the nichrome element wire through the tube, over the nick, and wind back down the tube. Mica sheet is used to insulate the element, being wound over a pencil and slipped into the hole before inserting the element.

The element having been wound, wires of a suitable length are hard-soldered to its ends, the centre one then being strung with ceramic beads. The element can then be carefully inserted into the bit.

The barrel is preferably made of thin brass tubing. The writer's "best" iron has a barrel constructed from a defunct bicycle pump—nice and light and perfectly cool well below the handle. No more burnt fingers. A "take down" model is not necessary. Have used one of these irons for months with no trouble occurring. In any case, they are cheap, simple, and quickly made. So we hard-solder the barrel to the bit, and before attaching the handle, hard-solder the flex to the wires leading from the element.

The handle is a matter for individual taste and ingenuity. The "best" one referred to has a handle made from an old knife-switch handle—the flange is excellent for upside-down soldering.

With regard to the element. A 6.3 volt 30-watt was thought to be the berries, but this would require nichrome stout enough to carry some 5 amps.—a bit much. So 12 volts was decided upon—allowing the iron to be used in emergency across a 12 volt battery. This required wire to carry 2.5 amp., and 1 k.w. heater wire will do that easily and is easy to get (one burn-out element will make several irons). The resistance of the first couple of irons made was meticulously measured on a megger, but this is not necessary, and measurement on an ordinary ohm-meter has proved to be accurate enough. The first transformer wound was provided with a "keep alive" winding of 10 volts, as it was thought that the bit would probably burn if left too long on full voltage. However, this also is unnecessary. Have had the iron going for eight hours without the need for re-tinning.

At least a dozen of these irons have been made by various chaps, with unvarying results. They range from one not much larger than a lead pencil, with a long thin bit for those hard-to-get-at places, up to a re-hashed 60-watt.

They have another advantage, too. Being low voltage, shocks from casual handling are minor, and if one likes to work all over the bench, leads can be run on stand-offs right along the bench, the iron being clipped on with alligator clips just where required.

## WHY PAY MORE!

**MAJOR—40 and 80 Metre Band  
CRYSTALS — 30/-**

**Mounted in latest type octal  
miniature holder — 39/6**

**All crystals are ground to your specified  
frequency and guaranteed accurate to within  
.02%.. Only latest imported equipment  
used for calibrating.**

**PROMPT DELIVERY.**

**V K 3 N U**

**Major Radio & Electrical Co.**

**189 Glenferrie Road, MALVERN, Vic.**

U 9354

WM 1814

## DOING IT THE HARD WAY.

We don't advise anyone to put this story to the test—at least, not until stocks increase—but its authenticity is vouched for by Philips Electrical Industries of Sydney.

Some time ago, off the coast of Holland, the S.S. "Meerkerk" ran foul of a mine and sank. About six weeks after the disaster portion of the cargo was washed ashore, and among the cases was one containing Philips metal-sprayed radio valves.

Eventually, thorough tests showed that although the outside lacquer had suffered from immersion in sea water, the valves still functioned perfectly.

The incident calls to mind the story of another Philips valve washed up at Maroubra after the wreck of the "Belbowrie" in 1938. After merciless battering among the rocks and in the surf, the valve was dried, tested, and came through with an A1 pass.

Although Philips assure us that they're not in the habit of shipwrecking valves to test their strength, they are rather proud of these examples of durability and robust construction.—Philips Electrical Industries of Aust. Pty. Ltd.

## AN ABSORPTION WAVEMETER FOR 50 Mc. BAND

A simple satisfactory wavemeter for this band can be made as follows:—

Wind four turns of No. 16 S.W.G. wire 1 inch diameter and self-supporting and space the turns to occupy half an inch. This coil is wired in series with a 2 volt 60 Ma. lamp and a 5 plate midget variable condenser and the whole assembly mounted on the end of a strip of ebonite.

The comparatively large diameter coil enables better tracing of R.F. (such as in heater leads). The wavemeter should tune to 50 Mc. with the condenser about three-quarters meshed.—"Break In," December 1946.

## 807's AS ZERO BIAS TRIODES.

From "Break In"

Ken McEwen, ZL2WS, has sent us the following letter received from Amalgamated Wireless Valve Co., and has given us permission to reprint it:—

"Further to your letter regarding the use of type 807 valves as zero bias high- $\mu$  triodes in class B audio amplifiers, we have carried out some tests on valves operating under these conditions, and are satisfied that this type of operation looks very attractive. At a plate current of 25 Ma., the electrical characteristics are approximately:—

Amplification Factor—220.  
Mutual Conductance—5,000 umhos.  
Plate Resistance—44,000 ohms.

"Plate current at zero bias in approximately as under:—

Plate Voltage	Plate Current.
200	4 Ma.
300	5 Ma.
400	7 Ma.
500	8 Ma.
600	9.3 Ma.
700	11 Ma.

"We have not yet been able to draw the plate characteristic curves into the region of high plate currents, which can only be done by an oscillographic method, and will therefore take some considerable time, but we propose to build up an amplifier and carry out dynamic tests, including measurements of distortion in order to obtain the optimum load resistance, power output, distortion and grid drive. We then propose to design a driver stage and step-down transformer to give the optimum results for this amplifier. The results will then be described in 'Radiotronics.'

"We are very grateful to you for bringing this matter to our attention and we are taking prompt action to make use of the idea.

AMALGAMATED WIRELESS VALVE CO. PTY. LTD.  
F. Langford-Smith, Chartered Engineer (Aust.)."

## CRYSTALS FOR PUSH-BUTTON TUNERS.

The greatest problem confronting most manufacturers of quartz crystals has been to find new ways of utilizing their enormously increased production facilities developed during the war. Because improved techniques have lowered costs in quantity production, applications of crystal control are now being considered which were formerly limited to low-production, high-unit-cost apparatus.

One such application is in push-button tuning of broadcast receivers. While crystal tuning of receivers has been used for many years, it was formerly employed solely on special purpose equipment, such as aircraft, marine, and other apparatus in limited production. Now, however, at least two of the larger manufacturers of broadcast receivers (U.S.A.) are planning to go into mass production of sets employing crystal control of the frequencies used for push-button selection. Obviously, this method will have advantages over former systems, provided costs can be held to a reasonable figure. Less servicing will be required and more precise tuning will result.

To keep costs down, it would be well for all manufacturers contemplating using this system to get together and decide on a standard intermediate frequency so that the stock of crystals required to produce the intermediate frequency will be kept to a minimum. Otherwise, the wide variety of crystals needed to cover all frequencies in the broadcast band may create inventory problems for the manufacturer and the radio serviceman. Experience has shown that new developments which are difficult or expensive for the serviceman to handle stand little chance of wide acceptance.—Radio, October 16.

## HOOK-UP WIRE.

A thermoplastic insulated radio hook-up wire, tested to underwriters' standards, is now in volume manufacture in U.S.A. by Federal Tel. and Radio Corp., Newark, N.J. The extreme flexibility of Federal's Intelin hook-up wire, its small outside diameter, and permanent colors facilitate quick, accurate assembly and easy servicing.

It is stated that this wire is not affected by oxidation and changes in temperature, will not crack or become brittle, and will remain operative under all conditions of humidity. The tough, abrasion resistant insulation reduces the possibility of accidental damage. Because the thermoplastic insulation is highly resistant to flame, equipment wired with Intelin is free from fire hazard.

The wire is high in dielectric and tensile strength. Short time tests show a dielectric strength of 800 volts per mil with a 0.020 inch wall thickness; thirty days tests at 90°C show a tensile strength of 2100-2250 pounds per square inch.

The free stripping feature is an idea to quick servicing, the conductor is left clean and bright for instant tightly soldered connections. Available in solid or stranded types, the wire ranges in size from 24 to 14 for high or low voltage needs in radio, electronics, appliances and communications and comes in 14 brilliant colors.—Radio, October 16.

## "J" ANTENNA.

A properly measured up "J" aerial pulls strongly at its resonant frequency and is fairly sharp—sharp enough to put one "on the band" when used with a 1 or 2 turn ling to the tank.

Dimensions for a 50 Mc. "J" are:—

Radiator—9 feet 3 inches.

Twin Section—4 feet 7½ inches, spaced 13-16 inches.

V.I.R. Feed Line tapped on at 4½ inches.

From ZL2CX, "Break In," December 1946.

## FOR SALE, EXCHANGE, WANTED

9d. per line, minimum 2/-.

**WANTED TO PURCHASE.—BACK COPIES OF QST.** Year 1942: September. Year 1943: May, June, July, August, September, November, December. Year 1944: January, February, March, April, May, June, September, and October. If prefer, will exchange 1933 November, 1937 October and November, 1938 July, 1939 August, and 1945 February. Please contact and advise prices to W. R. Gronow, 2 Anthony Street, Glen Iris, S.E.6, Phone U 4285.

**FOR SALE.—Valves, brand new, EF50, 6AC7, 6AB7, 954, etc. 10 Parker Street, Pascoe Vale, W.8.**

**OPPORTUNITY SALE.—NEW:** 1 only, Trimax Multi-Tap Modulation Xformer, £2; 1 only HY61, Ceramic Base equivalent to 6L6G, £1/5/-; 1 only HY60, Ceramic Base, £1; 3 only HY25, 25 Watt Triodes, £1 each; 2 only 866, £1 each. **AS NEW** (guaranteed first-class condition): 2 only Triplett 3-in. 0-250 Ma. Moving Coil, £1/10/- each; 1 only Triplett 3-in. 0-100 Ma. Moving Coil, £1/10/-; 1 only Weston 3-in. 0-½ Amp. R.F. Moving Coil, internal Thermo, £2/10/-; 1 only Shure Xtal Mike, 15 ft. Cable, £5; 1 only Trimax Filament Xformer, £1/5/-; 1 only Henderson 250 Ma. 750 volt aside Power Xformer tapped 600 and 500 volts with various Filament Windings, £2/10/-; **XTALS:** 12 only, AT cut, blanks ¾-in. square, £1 each, all ground just below 7000 Kc. 25 assorted Xtals varying frequencies and cuts, 7/6 to 15/- each. Phone X 3823. G. Benwell, VK3KQ, 460 New St., Elsternwick.



For the  
Amateur  
Broadcaster

The Widest Possible Range in Town!

**RADIO  
Parts**

Most hams agree that there is nothing to equal the variety and quality of radio parts now being offered by L. & H. and their retailers.

Ask your broadcasting pals about L. & H. equipment — see for yourself! The unsurpassed performance of all L. & H. components is known all over Australia—guaranteed thoroughly efficient, reliable and built for years of quality service.

Check up on your requirements now! Let this list help you—

MICROPHONES  
COILS  
BATTERIES  
METERS  
SWITCHES

VALVES  
VIBRATORS  
TRANSFORMERS  
CHOKES  
CHASSES

CONDENSERS  
SPEAKERS  
RESISTORS  
LINEFILTERS  
Etc., Etc.

Helpful technical advice readily given upon request. Obtain latest lists and prices from your radio house.

**Lawrence & Hanson Electrical** **PTY. LTD.**

33 YORK STREET, SYDNEY  
87 ELIZABETH STREET, BRISBANE  
120 COLLINS STREET, HOBART

172 WILLIAM STREET, MELBOURNE  
60 WAYMOUTH STREET, ADELAIDE  
20 PATTERSON STREET, LAUNCESTON

## HEADQUARTERS FOR AMATEUR EQUIPMENT



# AEGIS CERAMICS

Vital little pieces of equipment which proved worth their weight in gold to the Services, these Aegis Ceramics are available right now to the Ham! The range is complete and every one is typical Aegis quality . . .

**TYPE S14**

Retail Price **5/-**

**TYPE S13**

Retail Price **4/9**

**TYPE FT4**

Retail Price **6/9**

**TYPE S12**

Retail Price **2/6**

**TYPE FT2**

Retail Price **4/7**

**TYPE S12A**

Retail Price **2/9**

**TYPE FT1**

Retail Price **3/9**

**TYPE GT2**

Retail Price **8/3**

**TYPE BH2**

Retail Price **5/10**

Attractive Discount to Licensed Amateurs.

**J. H. MAGRATH & CO.**

Distributors of Aegis Components : 208 Lt. Lonsdale Street, C.1.



# AMATEUR

MARCH  
1947

# RADIO

JOURNAL OF THE WIRELESS INSTITUTE OF AUSTRALIA

## for your Mixer Socket

A new Frequency Changer Valve—Philips ECH35—is due for early release. This valve—a triode-hexode type—will be of particular interest to amateurs planning new receivers.

### RATINGS:

Heater volts	6.3
Heater current	0.3 amps.
Plate	250 volts
Plate current	3.0mA.
Neg. grid bias	-2 to -23 volts
Grids 2 — 4 (screen)	100 volts
Screen current	3.0mA.
Conversion Slope	650 $\mu$ A/V.
Plate resistance	1.3 meg.
Osc. anode 100V.	3.3 mA.
Osc. grid current	0.2mA.
Osc. grid resistor	50,000 ohms
Osc. slope	2.8 mA/V.



# PHILIPS

Philips Electrical Industries of Australia Pty. Ltd.  
Sydney — Melbourne — Adelaide — Perth — Brisbane

PL11-46



FOR THE EXPERIMENTER & RADIO ENTHUSIAST

Registered at G.P.O., Melbourne, for transmission by post as a periodical.

# 6<sup>d.</sup>

KP3

## LET'S GET TO THE CORE OF THINGS

As with all KINGSLEY radio products the reason why "PERMACLAD" I.F.'s are now spoken of as the best in Australia is found in the ferromagnetic iron-dust cores used in their construction. Apart from the inherent technical superiority of iron-core tuning, every "PERMACLAD" I.F. is turned out on a production line that sets a particularly high standard of quality.

So from the first to the final step . . . that of oscillograph testing and tuning . . . each I.F. is made to give the absolute maximum in performance. The use of the enclosed pot-type ferromagnetic cores give KINGSLEY PERMACLAD I.F.'s a particularly high degree of permeability, high "Q" and gain.

OBTAINABLE FROM  
AUTHORISED KINGSLEY DISTRIBUTORS

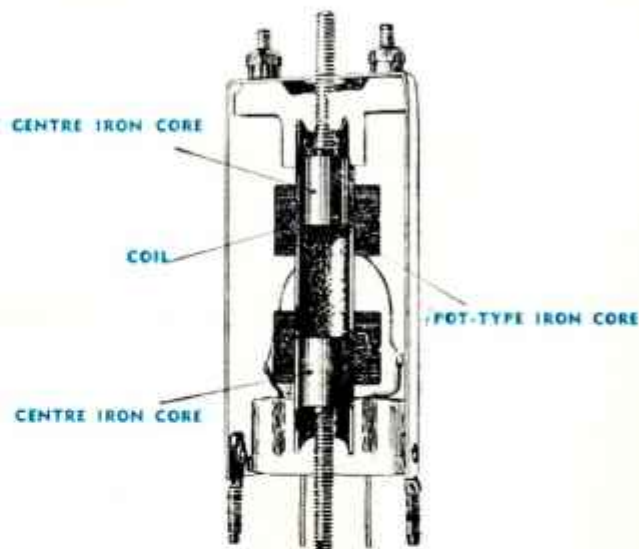

The above diagram is a cut away sketch of a PERMACLAD I.F. Tuning is done by the two centre iron-cores.

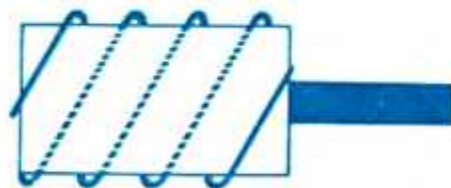

**F E R R O T U N E**  
FERRO-MAGNETIC IRON-CORE COILS, I.F.'s AND,  
GANGLESS TUNING UNITS



# KINGSLEY RADIO

KINGSLEY RADIO PTY. LTD.

380 St. Kilda Road, Melbourne, Victoria . Phones: MX 1159, MX 3653

# AMATEUR RADIO

*Published by The Wireless Institute of Australia,  
Law Court Chambers, 191 Queen Street,  
Melbourne, C.1*

**Editor:**

T. D. HOGAN, VK3HX.  
Telephone: UM 1732.

**Technical Editor:**

J. K. RIDGWAY, VK3CR.

**Notes Editor:**

R. W. HIGGINBOTHAM, VK3RN.

**Distribution:**

H. N. STEVENS, VK3JO.

**Business Manager:**

J. G. MARSLAND, VK3NY.

**Advertising Representative:**

W. J. LEWIS,  
20 Queen Street, Melbourne, C.1.  
Telephone: MU 5154.

**Printers:**

H HEARNE & CO. PTY. LTD.  
285 Latrobe Street, Melbourne.

MSS. and Magazine Correspondence should be forwarded to the Editor, "Amateur Radio," Box 2611W, G.P.O., Melbourne, on or before the 15th of each month.

Subscription rate is 6/- per annum, in advance (post paid).

— IN THIS ISSUE —

Direct Disc Recording .....	3
A Cathode-Ray Modulation Checker .....	5
1946 International D.X. Contest .....	6
Propagation Predictions for March .....	7
W.A.Z. Zone Boundaries Defined .....	8
Federal QSL Bureau .....	12
Federal Notes .....	12
Ramblings on the DX Bands .....	14
Fifty and Up .....	14
Divisional Notes .....	16
Taming an 807 .....	23

## EDITORIAL



During the recent war most of us had some experience of a new and sometimes disturbing factor in our everyday existence, a factor which went under the name of "Rationalisation." This term covered all kinds of things from two-color jam labels to a monotonous uniformity in the flavor of the kids' ice-creams. Whether or not all the things which were done under the name of "Rationalisation" were justified is an argument which we do not propose to enter into here, but there can be no doubt that the basic idea was right, that the end, that of making better use of the available manpower and materials, was substantially achieved.

The idea of rationalisation was forced upon this country by the greatest crisis in its history. The crisis has now passed (or has it?) but rationalisation is to some extent still with us. Once more, we do not propose to get ourselves into a political argument, but we have all come to realise that in some directions a little rationalisation is a good thing, inasmuch as it enables us to do more with limited resources.

We have been wondering recently whether Amateur Radio is perhaps in need of a little voluntary rationalisation. To-day we are faced with problems which in 1939 seemed rather re-

mote to most, anyway so far as we in this country were concerned.

Take our DX bands for instance. We have no more Kcs. in those bands today than we had in 1939, in fact in the popular 7 Mc. band we have for the moment a hundred less, but at the same time we are faced with greatly increased occupation of those bands. The answer must sooner or later be rationalisation of our methods of using those bands, perhaps in the form of sub-bands for Phone and CW, or perhaps a prohibition on short-distance contacts, or maybe other measures which we have not thought of yet. But whatever we do, we must do something effective and we must do it soon.

As we all know by now, there are two kinds of rationalisation, the voluntary kind and the other kind. It seems that the voluntary kind is to be preferred. Let us all do some very serious thinking about this problem so that we can find the right solution, and thus make our bands more enjoyable to use. We might also by this means give other users of the air less justification for their oft-repeated contention that the Amateurs are wasting useful space in the spectrum.

A H. C.

# HOMECRAFTS THE RADIO SPECIALISTS

290 LONSDALE STREET, MELBOURNE  
100 CLARENCE STREET, SYDNEY

A BARGAIN FOR HOME SET-BUILDERS

## THE GRAEMIE A.C. Mantel Kit Set

4 NEW TYPE VALVES  
REFLEX SUPER-HET CHASSIS  
8 INCH ROLA SPEAKER  
STREAMLINED PLASTIC CABINET

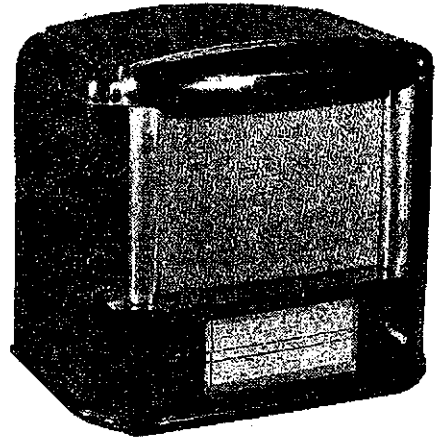

Complete, Ready to Assemble, A *BARGAIN* at £14/19/6

### 5-WATT PORTABLE AMPLIFIER

EXCLUSIVE TO HOMECRAFTS. A PERFECT UNIT FOR DANCE BANDS, PARTIES OR HOME RECORDING. COMPLETE with VALVES, MICROPHONE and CARRYING CASE £27/5/-

#### Radio and Electrical Specials:

LUCAS Army Spotlights . . . . . 35/-  
TRUTRAK Electric Pickups . . . . . 37/6  
CAPITOL Mike with transformer 17/6

REMOTE CONTROLS for interhouse  
Phones, £2/2/0.  
PEERLESS 1/16 h.p. Electric Motors  
£4/5/0  
GRAMO MOTORS WITH PICK UP IN  
PORTABLE CASE, £17/17/0

WRITE FOR NEW 1947 CATALOGUE. SEND 9d. TO COVER COST & POSTAGE

## HOMECRAFTS PTY. LTD.

MELBOURNE: Head Office, 290 Lonsdale Street. BALLARAT: 307 Sturt Street. GEELONG:  
132a Moorabool Street. SYDNEY: 100 Clarence Street. NEWCASTLE: 26 Hunter Street.  
HOBART, LAUNCESTON and BURNIE, TASMANIA.

# DIRECT DISC RECORDING

## PART V.—THE CUTTING STYLUS

(Based on a Lecture delivered to the Sound Recording Institute of Australia by Mr. L. T. Garrioch)

Readers who have been following this series of articles will have noted that an attempt has been made to review each component in the Recording Chain in turn, and that only two items require to be dealt with before that chain is complete. These are the Cutting Stylus and the Recording Disc, and the purpose of this chapter is to consider the first-named in the light of some of the more important features only, as a full review of the subject would fill many pages.

Cutting Styli are essentially small tools which are clamped to the vibrating armature of the recording head, and should behave with a true cutting action similar to those used on a lathe. Their shape is illustrated in Figure 1, and for the normal range

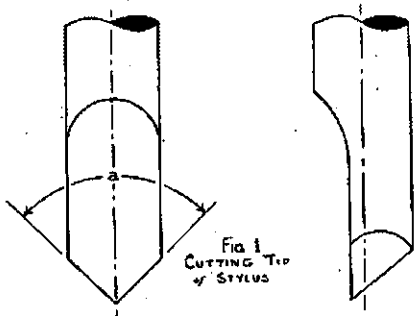

of direct recording discs the angle (a) is about 90 degrees. A small radius is sometimes provided at the tip in order that a rounded bottom is imparted to the resulting groove in the record, and it is claimed that this refinement tends towards more reliable performance as a sharp tip is likely to be more fragile. Both sharp and radiused points are in general use, however, and much depends upon the recordist's own experience and equipment in deciding which is preferable.

The first requirement of a stylus is that it be as sharp as possible along the cutting edges, and this in turn demands that all the surfaces be

highly polished or lapped after grinding. Any dullness of the cutting edges will produce noisy grooves, and impair the resulting signal-noise ratio during playback, and if the condition should be so bad as to be bordering on actual "bluntness," considerable difficulty in cutting may be expected. The second requirement is that it be rigid, in order that it will impart the high-frequency undulations to the disc. In this respect, the length of the shank is important, and should be chosen to suit the particular cutting head employed, so that not more than about  $\frac{1}{4}$ -inch projects from it when tightly clamped in position.

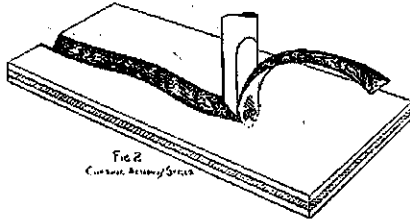

Figure 2 illustrates the action of cutting, and it will be seen that a continuous chip or "swarf" is produced. There is a certain amount of surface tension present in the uncut disc which is released when cutting, and this causes the "swarf" to shrink slightly as it leaves the disc, and to gather in a circle just inside the stylus track. Various methods are used for controlling the "swarf" so that it does not become entangled with the stylus. These range from suction and blowing devices in commercial and the more sophisticated amateur setups, to a humble soft-haired paint brush in the general run of installations. There are also some patented devices which can be purchased for the purpose. Generally speaking, the paint brush in practiced hands is quite satisfactory, and has the advantage that it cannot develop technical faults at a critical moment. A suitable choice is one which is about one-inch wide, and having soft bristles about  $1\frac{1}{2}$  inches long. There are certain adjustments which can be made to ensure that the "swarf" is thrown well clear of the stylus, and these will be referred to later.

In the case of Cellulose Nitrate coated discs which are most commonly used for instantaneous recording, a tendency is often met for the "swarf" to appear to be "magnetised,"

and to cling to the stylus during cutting, causing it to chatter or jump clear of the disc. This is due to an electrostatic charge being generated by the friction of cutting, and is most likely to occur with brand new discs which have been carefully packed in sealed containers. The "sealed container" practice for storing discs is an excellent method of preserving them against the ravage of dust and repeated changes of humidity, and should be encouraged, and the true solution of the difficulty is to seek a method of dissipating the charge as quickly as it is produced.

Tinsel streamers connected to the frame of the turntable system and playing on the surface of the disc are rarely satisfactory, and can give rise to tangling of the "swarf." The usual practice is to rub the disc surface lightly before cutting with a weak aqueous soap solution which is electrically conducting, taking care to run it well in to the centre so that the clamping boss over the centre pin can make contact with it. In normal circumstances, the chances of securing discs which are so fresh that this charge effect is troublesome are not great, and as a rule there is sufficient moisture adhering to the coating to cause it to dissipate.

It should be noted that when cutting the spiral from inside to out, the presence of such charge effects will not cause trouble because the stylus is continually moving away from the adhering swarf. The effect is also markedly less when cutting at 33.3 r.p.m.

The depth of groove cut in the disc is all-important, and special care must be taken to ensure that it is correct. Usually it lies between 0.0015-inch and 0.0025-inch. Less than 0.0015-inch will give considerable trouble during playback, while any attempt to exceed 0.0025-inch will promote vertical chatter and run the risk of damaging the stylus. There are two methods of gauging the depth of cut—the first being by examination of the swarf, which is usually said to be correct when its thickness is about that of human hair. Dextrous fingers, patience, and a micrometer can give the answer more correctly in "thous." The second method is by examination of the grooves with a microscope or magnifying glass, and estimating the groove-width at the surface in relation to the pitch of the grooves as produced by the traversing mechanism. For a 90-degree stylus cutting point, the depth of cut will be exactly half of the surface groove-width, although a radiused point will modify this slightly. For groove pitches between 100 and 130 lines per inch the correct depth of cut will give equal widths to adjacent grooves and "lands." (Note: The "land" is the

uncut portion of the disc between successive grooves.) Below 100 lines per inch, the groove-widths are about 2/3rds of the width of lands. These two cutting conditions are usually spoken of as "50-50" and "40-60" respectively, to indicate the relative proportions between groove and land.

Adjustment of groove-depth is made by varying the resultant downward pressure of the cutting head on the disc, either by means of a counter-balance weight, or with an adjustable spring. As mentioned earlier, this pressure is approximately 37 grammes for the average disc.

The life of a stylus is obviously governed by the wear-hardness of the material of which it is made, the end-point of its usefulness being when the cutting edges become dulled sufficiently to yield a noisy groove. Three materials normally used are steel, stellite, and sapphire, the latter two usually being a small chip secured to a metallic shank for insertion into the cutting head.

Their relative useful cutting lives are respectively about 30 minutes, 2 hours, and 6 to 10 hours, depending on circumstances. Their intrinsic hardness also has a large bearing on the high-frequency response, and for highest quality work the sapphire is the invariable choice. Unfortunately its relative fragility (and price) calls for the tenderest of care, and the aspiring recordist is recommended to stick to the more humble steel and stellite until he has well and truly perfected both his equipment and technique.

The natural wear of a stylus first becomes apparent at the surface line of the disc, and extends for about 0.001-inch below. Some authorities attribute this effect to variation in disc hardness from the surface inwards on account of varying surface tensions throughout the coating material. However, this dulling effect at the top of the groove walls may reach such proportions that a raggedness is produced where the playback needle will ride, and can cause the appearance of excessive scratch in the reproduction.

Periodic inspection of styli by means of a microscope of about 40 to 60 diameters magnification is recommended if such possibilities are to be avoided. Styli which show signs of dulling can be returned to the manufacturers for resharpening.

While examining a stylus in this way, it is also good practice to have a look at the tip in order to ensure that it is free from any defects caused by chattering or accidental damage in use. Although it is not normally subject to as much wear as the sections immediately above, any deformity can give rise to extraneous modulation of the groove. This usually

takes the form of a "hill and dale" or vertical modulation along the lines shown in Figure 3, and may be of sufficiently high frequency as to appear in the reproduction as a "hiss." However it may be low enough in the musical scale as to take the form of a whistle. If the tendency is slight, the effect will occur only at the bottom of the grooves, but if not, the side walls may also be impaired, which is the usual condition for it to be heard as a whistle. Close examination of the grooves with a microscope and suitable illumination will usually reveal the presence of this effect.

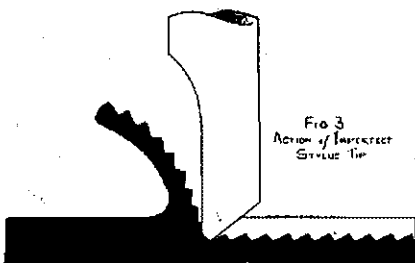

It is now necessary to add a few words about the adjustment of the stylus relative to the recording disc in order to secure optimum results. The "face" of the tool should be square on to the incoming disc material, and this is usually well catered for by the provision of a "flat" on the stylus shank where the clamping

angle made by the cutting face relative to the disc surface, and is sketched in Figure 4. The correct angle is 90 degrees, or a few degrees under it, as shown in (b). If it is greater than 90 degrees, as in (a), a digging-in action is set up, and a noisy, bouncing cut results. (The effect can be disastrous to a sapphire stylus.)

A dragging angle as in (c) will give a noisy, rough cut, and possibly a whistle when playing back. There is also the likelihood of the swarf coming off in a dry powdery condition instead of a clean uniform thread, indicating that the groove is being "torn" rather than cleanly cut in the disc material. The correct setting can be readily checked by noting the reflection of the stylus (side view) in the high polish of the disc surface, when a 90 degree condition will be revealed by the cutting face and its reflection lying in a straight line as in (b). It should be noted that these remarks do not apply to the position of the cutting head itself, but to the face of the stylus only. Certain makes of stylus have an undercut face as sketched in (d), where the axis of the stylus is not parallel to the plane of the face. The angular setting, however, is still made with regard to the cutting face as shown.

It is often a convenience to provide means for varying the cutting angle slightly while the recording is in progress, as there may be a slight tendency to whistle if a hard spot in the

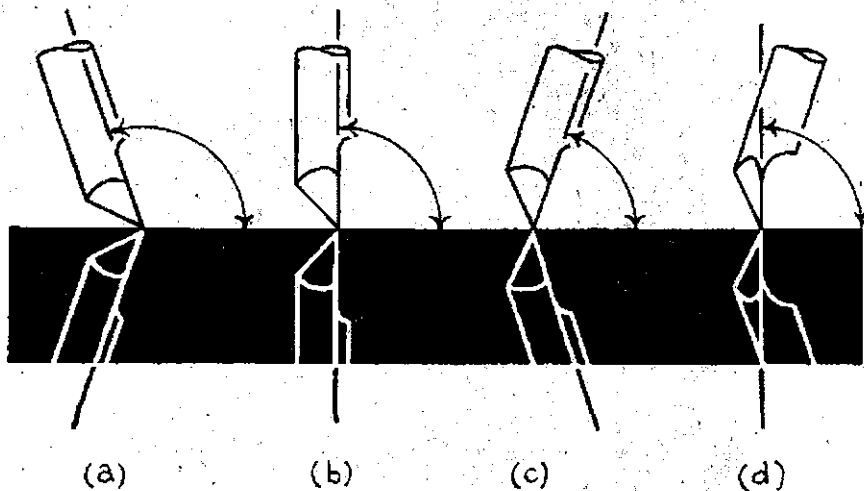

FIG 4 - ADJUSTMENT OF CUTTING ANGLE.

screw bears. There are, however, two further adjustments which must be made by the recordist before satisfactory cutting conditions can be achieved. The first of these is the

disc is encountered. The most common and probably the most satisfactory way of doing this is to provide means on the carriage of the

Continued on Page 22



# 1946 W.I.A. INTERNATIONAL DX CONTEST

Although the DX Contest held last November could not be classed as the outstanding success of previous years it did provide a loosening-up effect for the DX boys. There were several causes for the low number of entries. Not the least of which were the generally unsettled conditions of the Ham bands at the time and the difficulty of sufficient forward publicity with other countries. Still, in spite of these drawbacks, we have scores of letters from Hams who say they enjoyed themselves and are looking forward to the next "big do" in October this year.

Our heartiest congratulations go to VK2EO, VK2ADT and VK2DG as well as to Eric Trebilcock BERS-195 who topped the Open, 28 Mc., 14 Mc. and receiving sections respectively for Australia. We feel that VK2 will not be allowed to get away with the prizes next contest!

The bulk of the overseas logs clearly indicate that they had been submitted purely to enable our boys to get the benefit of points scored. To those Hams who did this we extend our thanks and we sincerely appreciate their co-operation. The same goes to the R.S.G.B., A.R.R.L., and all other Radio Societies who co-operated to the fullest extent in publicising the Contest.

One serious difficulty has arisen and that is the allocation of the prizes generously donated by some of our worthy advertisers. Through a lack of entries in as many sections as we had hoped for we have trophies unawarded. The winners will be given a choice of prizes and we trust our donors will permit us to hold the other awards over for our next Contest.

## AUSTRALIA TRANSMITTING SECTION

### Open

VK2EO	7164	VK2ADT	1980
VK2JX	6762	VK6RU	1500
VK2RA	5265	VK3XK	1488
VK3KX	5115	VK5JS	1098
VK2QL	4572	VK3HT	345
VK2YL	3600	VK5LC	330
VK2ZC	3564	VK6RL	3
VK6KW	2013		

### 28 Mc.

VK2ADT	1908	VK3PG	492
VK2ADE	1710	VK5MP	465
VK2YL	1236	VK2AHM	414
VK2JX	975	VK5WG	408
VK3KX	960	VK2ZC	369
VK2RA	900	VK2OE	351
VK5KG	720	VK3ABA	65
VK3YV	615	VK3DW	18
VK2QL	564		

### 14 Mc.

VK2DG	1710	VK7LJ	1296
VK3KX	1638	VK3CN	1044
VK2JX	1638	VK4TY	828
VK2ZC	1638	VK3GU	774
VK2AHA	1512	VK4HR	735
VK2DA	1440	VK4RC	720
VK2QL	1386		

## RECEIVING SECTION

Call Sign	Section	Score
BERS-195	Open	1836
VK3-ERS	Open	1728

## OVERSEAS

Country	Call	Section	Score
Mexico	XE1A	14, 28	1404
Argentina	LU7AZ	14	870
Neth'lands	PA000	28	330
Hawaii	K6CGK	14	756
"	KH6DD	14, 28, 7	1995
C'slovakia	OK1AW	28, 14	39
"	OK1CX	14	30
"	OK1FF	14, 28	411
Canada	VE1EP	Open	60
"	VE6AO	Open	126
Swit'land	HB9FJ	14	36
Alaska	KL7EZ	14	3
Chile	CE4AD	14	216
Macas.	CR9AN	14	630
India	VU2LR	28	954
Sweden	SM3UT	Open	6
S. Rhodes.	ZE1JB	28	81
S. Africa	ZS5U	14	450
U.S.A.	W3BES	Open	1650
"	W9AEH	Open	1539
"	W8LEC	Open	1419
"	W2BHW/8	Open	1368
"	W6AM	28	108
"		14	672
"		Open	1128
"	W6PNO	Open	816
"	W2BBK	14	630
"	W2COK	28	240
"	W6UZX	28	204
"	W1BIH	Open	72
"	W3GHD	Open	36
"	W0MPK	28	36
"	W0CFB	Open	18
"	W8DA	Open	18
G. Britain	G6CJ	Open	2079
"	G8IG	Open	666
"		28	225
"		14	300
"	G8QZ	14	330
"	G3QD	28	192
"	G5MY	14	90
"	G2FKO	28	22

## RECEIVING SECTION

Country	Call	Section	Score
G. Britain	BRS-1535	Open	1170
C'slovakia	OK-RP-709	Open	1116
Swit'land	HB9RLA	Open	915

## HIGHLIGHTS

LU7AZ gave many VKs a good opportunity for a South American contact on 14 Mc. He worked 58 stations in all.

KH6DD pushed up a fine score of 4500 points with 1 KW input.

It was good to hear old W6AM on the job again. Don doesn't say how many watts go to a Californian kilowatt these days!

W2BBK says he would have done better if W2NRM had returned the 8JK beam he borrowed prior to the contest. It is a matter of a "signal squirter" being turned into a "points snatcher!"

William Ely, BRS-1535, says that there are a lot of lousy notes in Europe, but that the VK boys are good.

G8IG reported having lots of fun and is warming up to the next Contest in October.

G6CJ, the winner of the U.K., made some useful checks against his logs during the 1935/6 contest and finds that 14 and 28 Mc. bands performed very closely to the 1946 conditions with the exception that they opened up about an hour earlier. G6CJ used a 200 feet vee aerial directed on VK.

Many participants stated that they like the idea of a multiplier by Continents instead of countries. Anyhow, these days who can define a country? VK3ML would like to hear some views on this contentious feature.

VK6FL turned in a fine log but too late for judgment.

VK6 boys had a tough time with rail strikes and power restrictions—lets hope all these blow over before October.

VK5KG's effort with a 6C6-37 type receiver was a credit and should prove to the younger boys that DX is not a measure of the number of bottles in a receiver—some say it is 90% operator and 10% receiver.

VK4RC got his W.A.C. in one night with a new aerial—a centre fed doublet vertical—and it proved a winner for the rest of the test.

VK2DA was not up to his usual DX Contest standard through family illness half way through—hope things are better in October Harry.

VK2EO tells us that this was the best Contest he has ever been in—a Continent multiplier is the shot he says.

Well boys, that is all for the 1946 Contest. Get your gear and pencils sharpened up for the big 1947 VK-ZL trials in October.

We know that you all join with us in stating that our friends, the advertisers who supported the Contest, helped to make the test the enjoyable one it turned out to be and we thank them for it.

VK3ML, Contest Manager.



# "LINK" FREQUENCY MODULATED

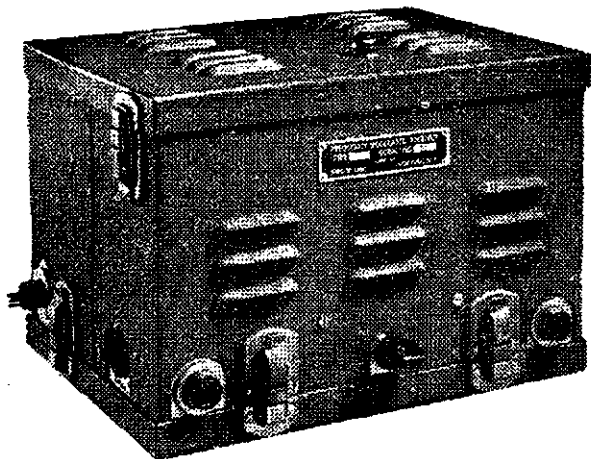

## 10-VALVE MOBILE RECEIVER

TYPE 1305 — CRYSTAL CONTROLLED —  
FREQUENCY RANGE 30-40 MC.

Includes Inter-Comm. for 2 operators. Size.—12" x 9-1/8" x 8-1/2"  
Power Output.—1/2 watt.  
Tubes include—  
14W7—RF amp.  
14W7—1st Det.  
14C7—Crystal Osc. — Multiplier.  
14S7—2nd Det. Crystal Osc.  
14W7—1st Limiter.  
14W7—2nd Limiter.  
7AG—Discriminator.  
7AG—Squelch Rectifier.  
14F7—First Audio Squelch.  
14C5—Audio Output Amp. Inter-Comm.

Freq. Deviation—15 K.C.  
Audio Response—  
3DB 300-3000 cycles  
Operates off 12 Volt D.C. Power Supply, Internal Dynamotor.  
Power Output, 12/14 volts, 4 amps. (12 V. accumulator)  
Output Impedance, 500 ohm to feed 2 headsets.  
Control. Direct.  
Weight.—20 lbs.

Guaranteed new in sealed Cartons  
with Instructions and Service Manual .. £15/15/0

RADIO AND REFRIGERATORS **VEALLS** ELECTRICAL AND LIGHTING

*Sales and Service* MELBOURNE, VEALLS (SWANSTON ST.) PTY. LTD. Telephone *F5145*  
243 SWANSTON ST. MELBOURNE  
PRAHRAN, VEALLS (PRAHRAN) PTY. LTD.  
239 CHAPEL ST. PRAHRAN  
MAIL ORDERS BOX 21417

## PROPAGATION PREDICTIONS FOR MARCH, 1947

The following information is taken from the Radio Propagation Bulletin for March 1947, No. A.R.P.C. A27.

**Zone E.—Latitude 10° South (Nth. Queensland, Northern Territory, Nth. Western Australia):—**

Maximum useable frequency 56 Mc. (2500 miles' skip).

**7 Mc.—**With the exception of a short period at 0500 hours when skip is 250 to 300 miles, this band does not offer many possibilities.

**14 Mc.—**At midnight skip is 600 miles, rising to about 1,400 miles at 0500 hours, then decreasing steadily to zero at 1500 hours. From 1500 hours to midnight an increase to 600 miles is noticed.

**28 Mc.—**At midnight skip on this frequency is 200 miles, rising to 2,500 miles at 0200 hours. After this time, the band becomes unsuitable for long distance working until 0800 hours when skip is once again 2,500 miles, decreasing to about 800 miles at 1500 hours, and rising to 2,000 miles at midnight.

**50 Mc.—**A study of the charts promises a return of the conditions which prevailed on this band during November of last year. Watch for a peak of 2,000 to 2,500 miles' skip

which should appear between the hours of 1300 and 1600.

**Zone E.—Latitude 20° South (Sth. Queensland, New South Wales, Sth. Australia, Southern W. Australia):—**

Maximum useable frequency is 46 Mc.

**7 Mc.—**Useless until 0300 hours when a peak appears which rises to 500 miles at 0500 hours and fades out again at 0630 hours.

**14 Mc.—**Skip at midnight is 800 miles. At 0200 hours an increase, which rises to 1,500 miles at 0500 hours, is noticed. From 0500 hours to 1400 hours a steady decrease to about 300 miles is seen, then an increase to 800 miles at midnight.

**28 Mc.—**Opens up at 0700 hours with skip of 2,500 miles. This decreases to about 1,200 miles at 1400 hours, then rises to a maximum of 2,500 miles at 1900 hours, after which time the band fades out.

**50 Mc.—**Although the maximum useable frequency is given as 46 Mc., there may be a possibility of something doing on this band around 1500 hours.

**Zone E.—Latitude 30° South (Victoria, Southern N.S.W., Southern S.A., and Southern W.A.):—**

Maximum useable frequency is 38 Mc.

**7 Mc.—**At midnight skip is about 400 miles, rising to 800 miles at 0530 hours, then fading out entirely at 0700 hours.

**14 Mc.—**Skip at midnight is 1,500

miles, rising to 2,500 miles at 0330 hours, then fading out until 0600 hours. From 0700 hours until 2100 hours, skip is fairly steady at 500-600 miles.

**28 Mc.—**At 0800 hours a period of 2,000-2,500 miles' skip commences and lasts until 2000 hours. Both prior to and following this period skip is not present.

**Zone E.—Latitude 40° South (Tasmania):—**

**7 Mc.—**Except for a peak of 500 miles at 0500, skip is not present.

**14 Mc.—**At midnight skip is 1,200 miles, rising to 2,000 miles at 0500 hours, then decreasing to 500-600 miles at 0900 hours. This period of 500-600 miles' skip, lasts until 1800 hours when a steady increase to 1,000 miles at midnight takes place.

**28 Mc.—**Nothing until 0900 hours when a period of 2,500 miles' skip commences. This period lasts until 2000 hours, then fades out entirely.

The foregoing information is given for transmissions by way of the F2 layer. It should be noted that the state of ionisation of the E layer often makes possible the use of higher frequencies for distances of 1,000 miles than can be used for distances of 1,500 miles via the F2 layer.

Our copy of the Radio Propagation Bulletin A.R.P.C.-A27 by courtesy of the Australian Propagation Committee of the Radio Research Board of the Council for Scientific and Industrial Research.

# W.A.Z. ZONE BOUNDARIES DEFINED

"CQ," the successor to the old "Radio," announces the resumption of W.A.Z. honor roll listing in the editorial pages of the magazine. In addition a handsome certificate, suitably inscribed, will be awarded to any station proving two-way communications with each of the forty established zones. Certificates will be numbered as issued.

In determining zone boundaries originally, it was admitted that no two persons in the world would probably make up exactly similar lists. Careful attention was given to typrographical maps, calls heard lists, and similar factors in compiling the zone lists. For convenience in determining the zone in which a distant station may be located, zone lines have in most cases been made to coincide with political or call area boundaries, even where slight departures from natural geographical boundaries were necessitated. No consideration has been given to the number of amateur stations which may be located within a particular zone, as this is a factor of no permanence. In the post-war period after much debate and discussion, it was decided to let the original zones stand intact. This means that some political and call area boundaries will have been altered by the war and if, after the peace conference minor re-adjustments are called for, they will be made.

The plan has been laid out as carefully as possible without reference to any particular country or portion of a country. The number of zones on each continent is roughly proportional to its area. In the zone list some overlapping units are included, that is, many places listed are subdivisions of others also listed. This has been done purposely because sometimes one of the names is omitted in the postal address given on QSL cards.

For listing in the new W.A.Z. honor roll it is only necessary to drop a note to the DX Editor or to CQ Magazine, 342 Madison Ave., N.Y. 17. Total pre-war and post-war zones and countries are desired, although listing will be in order of post-war zones worked.

The foregoing and the list defining the zone boundaries has been reprinted from "CQ" in the belief that Australian Amateurs will be interested.

## Zone 1—Northwestern Zone of North America:—

Alaska KL7  
Yukon (part of) VE8  
Canadian Northwest Territories (part of) VE8

District of Mackenzie VE8  
District of Franklin VE8  
Islands west of 102° W., including Victoria, Banks, Melville and Prince Patrick.

## Zone 2—Northwestern Zone of North America:—

Canada, that portion of Quebec (part of VE2) north of an east and west line drawn along and extended from the southern boundary of Labrador.

Canadian Northwest Territories (part of) VE8

District of Keewatin.  
District of Franklin east of Long. 102° W., including Islands of King William, Prince of Wales, Somerset, Bathurst, Devon, Ellsmere, Baffin, and the Melville and Boothia Peninsulas.

## Zone 3—Western Zone of North America:—

British Columbia (part of VE7)  
W7 except Wyoming and Montana  
All W6.

## Zone 4—Central Zone of North America:—

All VE3, VE4, VE5, VE6.  
W5, W9 and W0.  
Wyoming and Montana (part of W7).  
Ohio (part of W8).  
Tennessee, Alabama and Kentucky (part of W4).

## Zone 5—Eastern Zone of North America:—

All VE1, VO, W1, W2, W3.  
VE2 (Quebec) south of line mentioned in Zone 2.  
W4 except Tennessee, Alabama, and Kentucky.  
W8 except Ohio.  
Bermuda VP9  
Swan Island KD4

## Zone 6—Southern Zone of North America:—

Mexico XE

## Zone 7—Zone of Central America:—

Honduras HR  
British Honduras VP1  
Guatemala TG  
Costa Rica TI  
Nicaragua YN  
Panama HP  
Canal Zone KZ5

## Zone 8—West Indies Zone:—

Cuba CM  
Puerto Rico KP4  
Virgin Islands KV4  
Cayman Islands, Jamaica, Turks and Caico's Islands VP5  
Bahamas VP7  
Barbados VP6  
Haiti HH  
Dominican Republic HI  
Dominica, St. Lucia, Antigua, St. Kitts-Nevis VP2

Guadeloupe FG8  
Martinique FM8  
All Greater and Lesser Antilles except Bermuda and those listed in

## Zone 9.

## Zone 9—Northern Zone of South America:—

Colombia HK  
Venezuela YV  
Dutch Guiana PZ  
French Guiana FY  
British Guiana VP3  
Trinidad VP4  
Curacao PJ  
Tobago VP4  
Grenada VP2

## Zone 10—West Central Zone of South America:—

Ecuador HC  
Peru OA  
Bolivia CP  
Colon or Galapagos Archipelago HC

## Zone 11—East Central Zone of South America:—

Brazil PY  
Paraguay ZP

## Zone 12—Southwestern Zone of South America:—

Chile CE

## Zone 13—Southeastern Zone of South America:—

Argentina LU  
Uruguay CX  
Falkland Island VP8  
South Shetland Islands VP8  
Georgia Island VP8

## Zone 14—Western Zone of Europe:—

Portugal CT1  
Spain EA  
Andorra PX  
France F  
Switzerland HB  
Belgium ON  
Luxembourg LX  
Saar EZ  
Germany (except East Prussia) D  
Denmark OZ  
Sweden SM  
Norway LA  
Great Britain G  
North Ireland GI  
Scotland GM  
Wales GW  
Channel Island GC  
Irish Free State EI  
Netherlands (Holland) PA  
Azores Islands CT2  
Faroes Islands OY  
Gibraltar ZB2  
Monaco PX

## Zone 15—Central Zone of Europe:—

Italy I  
Albania ZA  
Austria OE  
Liechtenstein HE  
Poland SP  
Finland OH  
Latvia YL  
Lithuania LY  
Estonia ES  
Czechoslovakia OK  
Yugoslavia YU  
Corsica SV  
Sardinia  
Hungary HA

Malta	ZB1	Aegean Islands	SV	Zone 23—Central Zone of Asia:—	
Sicily	I	Syria	AR	Chinese Republic, following por-	
San Marino		Palestine	ZC6	tions only:	C (XU)
Polish East Prussia		Transjordanian	ZC1	Tibet	AC
<b>Zone 16—Eastern Zone of Europe:—</b>		Cyprus	ZC4	Sinkiang (Chinese Turkestan)	
European portions of U.S.S.R. in-		<b>Zone 21—Southwestern Zone of Asia</b>		Tannu Tuwa (Tannou Touva)	
cluding European portion of So-		<b>Saudi Arabia:—</b>		China Proper (Kansu Province	
viet Russia, White Russia or Bel-		Saudi Arabia (Hedjaz, Nejd)	HZ	only)	
lorussia, Ukraine, and Novaya		Yemen		Outer Mongolia	
Zemlya.	UA, UB, UC	Oman		Inner Mongolia (except Chahar	
<b>Zone 17—Western Siberian Zone of</b>		Aden	VS9	Province)	
<b>Asia:—</b>		Asir		<b>Zone 24—Eastern Zone of Asia:—</b>	
Asiatic U.S.S.R.	UA	Iraq (Mesopotamia)	YI	China Proper (except Kansu Prov-	
Ural		Afghanistan	YA	ince	C (XU)
Kirghiz		Persia	EP	Inner Mongolia (Chahar Province	
Tadzhik		India (Baluchistan only)	VU	only)	
Turkomen		U. S. S. R. (Transcaucasia only,		Manchukuo (Manchuria)	MX
Uzbek		Georgia, Armenia, Azerbaijan)	UA	Kwangchow	
Kara Kalpak		Kuweit		Macao	CR9
Kazak		Behrein Island	VS8	Hong Kong	VS6
<b>Zone 18—Central Siberian Zone of</b>				Darien	
<b>Asia:—</b>		<b>Zone 22—Southern Zone of Asia:—</b>		Japan (Taiwan or Formosa only)	J9
Buryat Mongol	UA	India (except Baluchistan and		<b>Zone 25—Japanese Zone of Asia:—</b>	
Oyrat		Burma)	VU	Japan (except Taiwan or For-	
Siberian Krai (Eastern and West-		Assam		mosa)	J
ern).		Sikkim		Chosen (Korea)	J8
<b>Zone 19—Eastern Siberian Zone of</b>		Ceylon	VS7	<b>Zone 26—Southeastern Zone of Asia:</b>	
<b>Asia:—</b>		Nepal		Burma	XZ
Yakutsk	UA	Mahe		Siam	HS
Far Eastern Area or Dalnevostch-		Maldivo Islands	VS9	French Indo-China	FI
nyi.		Laccadive Islands	VS9	Andaman Islands	VU
<b>Zone 20—Balkan, Asia Minor Zone:—</b>		Karikal		<b>Zone 27—Philippine Zone:—</b>	
Rumania	YR	Bhutan		Philippine Archipelago	KA
Bulgaria	LZ	Pondichery		Guam	KG6
Greece	SV	Goa	CR8	Yap	
Crete	SV				

**A  
B  
A  
C**

**AUSTRALIA'S  
BEST  
AMPLIFIER  
COMPONENTS**

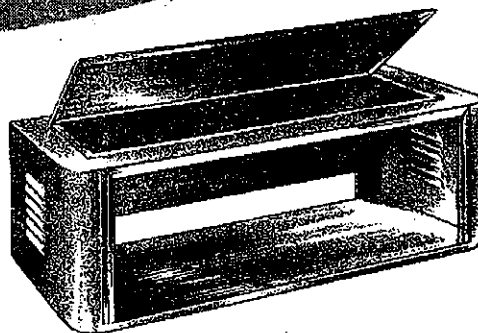

**ABAC  
Standard  
Receiver**

Or Instrument  
Case. Takes 19 x  
8½ panel with  
clear panel space  
17½ x 7½. Depth  
of case 11 inches.

MANUFACTURED BY

**TRIMAX TRANSFORMERS**

29-35 FLEMINGTON ROAD  
NTH. MELBOURNE, VIC.  
(Division of Chiff & Bunting  
Pty. Ltd)

# THE BAROMETER OF WORLD OPINION

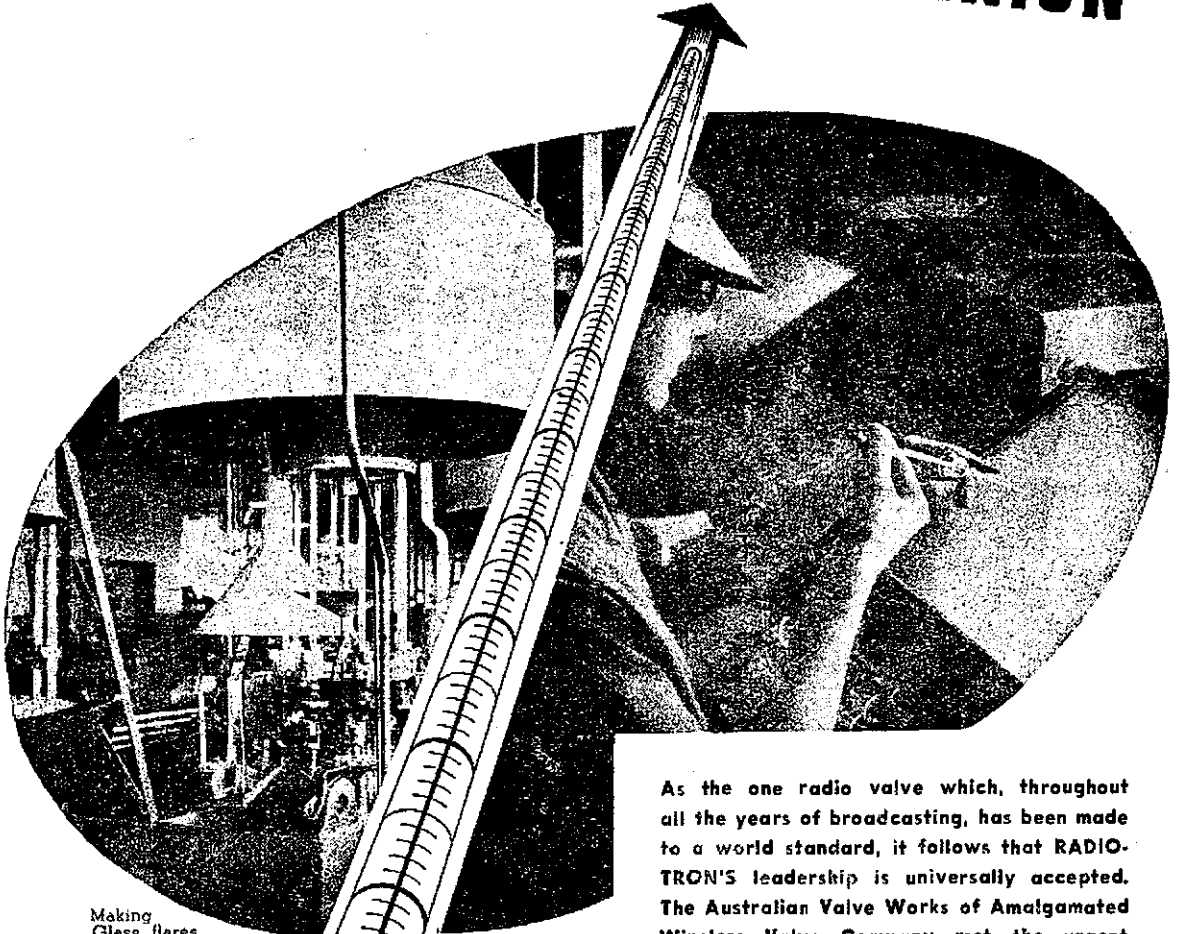

Making  
Glass flares  
for radio valves . . . . .

. . . . . Examining  
flares over an  
illuminated screen.

As the one radio valve which, throughout all the years of broadcasting, has been made to a world standard, it follows that RADIO-TRON'S leadership is universally accepted. The Australian Valve Works of Amalgamated Wireless Valve Company met the urgent needs and uncompromising standards of defence throughout the war — the same organisation, to-day, is increasingly competent to provide the growing needs of peace.

W3

AMALGAMATED WIRELESS  
VALVE COMPANY PTY. LTD.



**Radiotron**  
VALVES  
MADE IN AUSTRALIA

8E

Administration . . . . . 47 York Street, Sydney, N.S.W.  
 Manufacture . . . . . Parramatta Road, Ashfield, N.S.W.  
 Distribution . . . . . Crown Street, Glebe, N.S.W.

V2

8S

Caroline Islands	
Mariana Islands	KB6
Islands east of Philippines, west of Long. 163° E., north of Lat. 2° N., and south of a line from 153° E., 40° N. to 131° E., 23° N.	
<b>Zone 28—Malayan Zone of Asia:—</b>	
Malay States (Federated and Non-Federated)	VS2
Johore	
Straits Settlements	VS1
Malay Archipelago, including Netherlands Indies (Dutch East Indies)	
Java	PK
Sumatra	PK4
British North Borneo	VS4
Sarawak	VS5
Papua	VK4
New Guinea	VK9
Borneo	PK5
Solomon Islands	VR4
Timor Islands	CR10
Portuguese East Indies	CR8
Islands between Lat. 2° N. and 11° S., and west of Long 163° E.	
<b>Zone 29—Western Zone of Australia:</b>	
Australia	VK
Western Australia	
North Australia	
Central Australia	
<b>Zone 30—Eastern Zone of Australia:</b>	
Australia	VK
Queensland	
New South Wales	
Victoria	
Tasmania	VK7
South Australia	
Islands south of Lat. 11° S. and west of long. 153° E.	
<b>Zone 31—Central Pacific Zone:—</b>	
Hawaiian Islands	KH6
Ellice Islands	VR1
Gilbert Islands	VR1
Baker, Howland, American Phoenix Islands	KB6
Midway	KM6
Palmyra Group, Jarvis	KP6
Wake Island Group	KW6
Johnson	KJ6
Islands between Lat. 11° S. and 40° N., and between Long. 163° E. and 140° W.	
<b>Zone 32—New Zealand Zone:—</b>	
New Zealand	ZL
Loyalty Islands	
Tahiti	FO
Fiji	VR2
New Hebrides	FU8, YU
Samoa	KS6
New Caledonia	FK
Pitcairn Islands	VR6
Chatham Islands	
Islands south of Lat. 11° S. and between Long. 163° E. and 120° W.	
<b>Zone 33—Northwestern Zone of Africa:—</b>	
French Morocco	CN8
Spanish Morocco	EA9
Río de Oro	
Tunisia	FT4
Algeria (Northern & Southern)	FA
Ifni	
Madeira	CT3
Canary Islands	EA8

<b>Zone 34—Northern Zone of Africa:—</b>	
Libya	
Egypt	SU
Anglo-Egyptian Sudan	ST
<b>Zone 35—Western Zone of Africa:—</b>	
French West Africa	FF8
Nigeria	ZD2
Ivory Coast	ZD4
Gambia	ZD3
Cape Verde Islands	CR4
French Guinea	
Liberia	EL
Portuguese Guinea	CR5
Dahomey	
Ashanti	
Sierra Leone	ZD1
Senegal	
Gold Coast	ZD4
French Sudan	FD8
Togoland	FD8, ZD4
<b>Zone 36—Equatorial Zone of Africa:</b>	
Angola (Portuguese West Africa)	
	CR6
	FE8
Cameroons	
Spanish Guinea	
French Equat. Africa	FQ8
Belgian Congo	OQ5
Northern Rhodesia	VQ2
Cabinda	
Río Muni	
Gabon	
St. Helena Island	ZD7
Ascension Island	ZD8
<b>Zone 37—Eastern Zone of Africa:—</b>	
Mozambique (Portuguese East Africa)	CR7
British East Africa	
Kenya	VQ4
Uganda	VQ5
Tanganyika	VQ3
Nyassaland	ZD6
Ethiopia (Abyssinia)	ET
Italian Somaliland	
British Somaliland	VQ6
French Somaliland	FL8

Eritrea	16
Zanzibar Islands	
Socotra Islands	
Mafia Islands	
<b>Zone 38—Southern Zone of Africa:—</b>	
Union of South Africa	ZS
Southern Rhodesia	ZE
Swaziland	ZS
Basutoland	ZS
British Southwest Africa	ZS3
Bechuanaland	ZS
Tristan de Cunha Island	ZD6
Gough Island	
Bouvet Island	
<b>Zone 39—Madagascar Zone:—</b>	
Madagascar	FB8
Reunion Island	FR9
Seychelles Island	VQ9
Admirante Island	
Mauritius Island	VQ8
<b>Zone 40—North Atlantic Zone:—</b>	
Greenland	OX
Iceland	TF
Svalbard (Spitzbergen)	

**WINDING COILS WITH SPACED TURNS ON UNTHREADED FORMERS**

Wind wire of smaller and appropriate gauge on with and between turns of winding proper. If winding is sufficiently tight spacer wire can be removed before applying "dope." Alternative schemes are either to dope the former lightly before winding or merely dope coil at intervals after winding, allow dope to dry before removing spacer wire.

**STORING CO-AXIAL CABLE**

Prior to returning surplus co-axial cable to the shelf after cutting, the end should be sealed with suitable compound or dope in order to prevent moisture and corrosion creeping along the conductors.

**INSULATORS**

Large strain type, egg shaped . . . . . 16/6 dozen

**INSULATORS**

Small Egg Insulators . . . . . 3/6 dozen

**INSULATORS**

Standoff Insulators, 1" high with bolt . . . . . 1/6 each

Standoff Insulators, 1" high with banana socket . . . . . 1/8 each

Miniature Tubes for high frequencies.

6C4 . . 25/- . . . . . 6AG5 . . 30/- . . . . . 6J6 . . 32/6

Prices include sales tax, but not freight.

**AUSTRYL RADIO SUPPLIES**

T. D. HOGAN (VK3HX)

127 OAKLEIGH ROAD, CARNEGIE, S.E.9

Telephone: UM 1732

## FEDERAL QSL BUREAU

### VK3RJ QSL MANAGER

PY2AL, J. Levy Silva, Box 286, S. Paulo, Brazil, has come to light with cards confirming pre- and post-war contacts. Everything comes to those who wait—long enough.

One of the numerous cards from PY2AL is addressed to VK3AR confirming a 14 Mc. CW contact on September 2, 1946, at 0500 PY time. The correct owner of the card may have same on application to this Bureau.

A number of applications for W.A.C. certificates have been submitted and recommended during recent months. Stations making application for this award are reminded to submit their confirmations either direct to the Federal QSL Manager or through their Divisional Secretary. After checking, the cards will be returned by the Federal QSL Manager, direct to the applicant.

As the appointment of a successor to VK3RJ as Victorian QSL Manager has not yet been finalised, divisional QSL Managers and VK3 stations should continue to use the existing address: 23 Landale Street, Box Hill, E.11, Victoria, until further notice.

Writer has returned from an enjoyable and moderately successful prospecting holiday in the Blackwood district of Victoria. Although the humid spell "enjoyed" by Melbourne residents was avoided, a plague of March flies necessitated the constant wearing of gaiters and fly veil imperative during daylight hours while shirt sleeves had to be buttoned to the wrists. Even so up to 300 "contacts" a day were easily obtainable, the necessary confirmation being received at time of contact. The "insectosphere" predictions proved valueless as the "DX" arrived one month earlier than predicted while the maximum usable wavelength proved to be one arms length.

Cards are on hand at the Victorian Bureau for the following VK3 metropolitan stations as at 13/2/47:—VK3AB, AC, AE, AI, AO, AP, AT, AV, AAB, ABA, ABC, ABN, ACG, ACX, ADF, ADH, ADS, ADX, AES, AFD, AGE, AHB, AHX, AIG, AII, AJE, AJL, AJX, AKL, AKR, AKY, ALE, AOG, APM, ARB, ARK, ARP, ASV, ART, ATH, ATM, BC, BD, BF, BT, BX, BZ, CC, CI, CO, CT, CU, DA, DC, DD, DK, DN, DP, DZ, EC, ED, EG, EH, EJ, EK, EN, EO, ES, EV, EX, EZ, FE, FL, FM, FN, FP, FR, FS, FT, FV, FW, FY, GB, GG, GP, GT, GV, GX, HD, HI, HJ, HS, HV, IE, IK, IP, IT, IU, IW, IV, JD, JE, JH, JI, JT, JW, JY, KA, KB, KC, KT, KU, LA, LC, LL, LT, LZ, MD, ML, MP, MS, MU, MW, MX, NA, NB, NF, NL, OE, OV, OP, OZ, PA, PB, PE, PG, PI, PK, PM, PW, QB, QD, QE, QG, QI, QK, QL, QP, QQ, QR, RF, RR, RT, RV, RW, SB, SG, SK, SQ, SY, TE, TF, TH, TI, TQ,

## FEDERAL NOTES

### FEDERAL CONVENTION IN APRIL

The Annual Federal Convention of the Wireless Institute of Australia will be held in Melbourne at Easter. The Divisions of the Institute are now discussing the agenda items which will be decided at the Convention, and we hope you will go along to the Divisional meetings when Divisional opinions of items are sought.

We are happy to inform you that delegates will be present from all States, as we believe this is the satisfactory way to have a real expression of opinion from the individual Divisions.

### TELECOMMUNICATIONS CONVENTION

A world Telecommunications Convention is to be held during April or May and the Wireless Institute of Australia is being represented there by the I.A.R.U.

The I.A.R.U. has been informed of the W.I.A. views and they coincide with those of the I.A.R.U.

### W.A.S. CERTIFICATE

As announced last month, the W.I.A. is establishing a Worked All States Certificate for 50 Mc. and above. We now require a design for this Certificate and any Ham who has any artistic flair should send in a design. A prize will be offered the winning designer. Entries close at Melbourne on 31st March, so that the Federal Convention may decide the best design. Address your entries to Federal Executive W.I.A., Box 2611W, Melbourne. Now get cracking chaps!

### NEW BAND

Australian Amateurs have now joined the select ranks of those permitted to use the "QRM" band, in other words the "Medical and Industrial Band"—27.185 to 27.455 Mcs. This should be a very interesting addition to the allocations which we already have. The terrific QRM which will sooner or later emanate from Medical and Industrial Equipment on this band will challenge the ingenuity of Amateurs, and much

TR, TU, TY, UC, UD, UE, UH, UJ, UK, UM, UO, UP, VA, VC, VD, VH, VM, VO, VQ, VS, VU, VZ, WC, WF, WO, WX, XA, XD, XG, XJ, XN, XS, XT, YC, YF, YH, YM, YS, ZB, ZD, ZG, ZH, ZJ, ZO, ZP, ZT, ZV.

Send a stamped envelope to the Bureau and help keep the files less congested. If any country members are included in above list please advise the Bureau.

good, should arise from this aspect. We do not, however, share the opinion of certain very enthusiastic overseas magazines which seem to think that most of the hamburger and hot dog joints in the country will soon be operating on this band! Anyway, there it is, let us be sure that it is occupied without delay.

### RESTRICTION REMOVED

We are pleased to announce that advice has been received from the Wireless Branch that the thirty minutes limit on contacts has been abolished. While the intention behind the introduction a few years ago of this restriction was undoubtedly a good one, we believe that its removal will be generally welcomed. We would like all Amateurs to note, however, that the remaining portions of Rule 84, i.e. the good advice contained therein relative to the undesirability of band-hogging still apply. The Wireless Institute has gained the abolition of this restriction in the interests of all Australian Amateurs, so show your gratitude by still keeping your contacts down to a reasonable duration.

### V.H.F. OFFICERS

During the last month the Federal Executive has received notice of the appointment of a further two V.H.F. Officers, namely:—

South Australian Division:

Mr. R. T. Manuel, VK5RT,  
59 Gordon Road, Prospect, S.A.

Tasmanian Division:

Mr. C. Walch, VK7CW,  
10 Osborne Ave., Sandy Bay, Hobart.

Members interested in V.H.F. activities in these Divisions should contact their V.H.F. Officer without delay.

### NEW ZEALAND APPOINTMENT FOR PHILIPS EXECUTIVE

After more than 21 years' service with Philips Electrical Industries of Australia Pty. Ltd., Mr. Leighton Lord has been appointed Managing Director of Philips Electrical Industries of New Zealand Ltd. He will leave for Wellington this month.

Mr. Lord, who has been General Manager of Philips Electrical Industries of Australia for several years, has been very prominent in the electrical and radio field. Besides being a director of several companies, he was on the council of E.R.D.A., and was formerly president of the Illuminating Engineering Society of Australia (N.S.W.).

Mr. Lord's many friends throughout the Commonwealth will regard the promotion as well deserved and wish him every success in his new sphere.

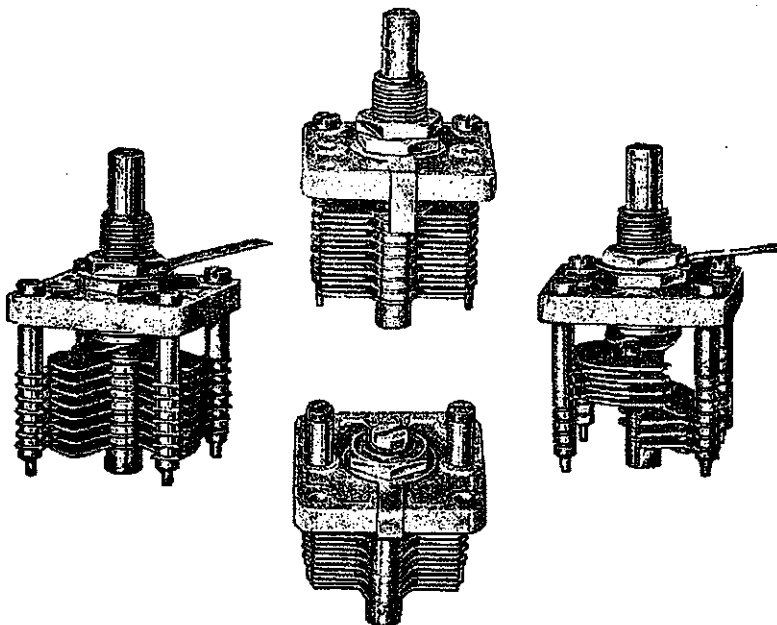

**EDDYSTONE** presents a new range of **AIR DIELECTRIC TRIMMER CONDENSERS** for amateur and professional use. All metal parts are of heavily silver plated brass with ceramic insulation. Spindles are extended for ganging.

Cat. No.	Max. Capacity	Price
581	60 pF	6/5
582	60 pF	10/10
580	15 pF	9/6
584	34 x 34 pF	14/2
583	25 x 25 pF	13/5

**DIRECTORY OF DISTRIBUTORS:**

**VICTORIA:**

**J. H. MAGRATH & CO.,**  
208 Little Lonsdale Street, Melbourne.

**NEW SOUTH WALES:**

**JOHN MARTIN PTY. LTD.,**  
116-119 Clarence Street, Sydney.

**QUEENSLAND:**

**CHANDLERS PTY. LTD.,**  
Cnr. Albert and Charlotte Sts.,  
Brisbane.

**WEST AUSTRALIA:**

**CARLYLE & CO.,**  
Hay Street, Perth, and at  
397 Hannan Street, Kolgoorlie.

**SOUTH AUSTRALIA:**

**GERARD & GOODMAN LTD.,**  
192-196 Rundle Street, Adelaide.

**TASMANIA:**

**W. & G. GENDERS PTY. LTD.,**  
53 Cameron Street, Launceston.

**AUSTRALIAN FACTORY REPRESENTATIVES:**

**KEITH HARRIS & CO. PTY. LTD.**

**51 WILLIAM STREET, MELBOURNE.**

## RAMBLINGS ON DX BANDS

Ray Friddle (VK2RA), in a letter, says by working PK5LK he raised his post-war DX score to 100 countries, and I daresay readers of DX notes will be interested.

Some of the choicest ones are VP8AD, UD6BM, PZ1RM, TF3A, VQ5JTW, ZA2D, AR1PC, TINS, UI8AA, ZB2B, ST2AM and PK6AX (Celebes). He did not record the

frequencies, because most seem to use V.F.Os. these days.

He will not be very active for the balance of this year, as he is moving into a new house in about three weeks, and you probably know what that means. However, he is hoping the new QTH will be as good for DX as his present one. The main advantage of the present location is that a hill to the East makes it difficult to hear or work Ws! He hopes they all QSL so that he can get the Australian DX C.C., hi.

R. Campbell (VK4RC) jumps to the defence of DX conditions in Queensland. He says there was some interesting reading in last month's issue of what the VK3s and 5s were doing on the DX bands, so he thought he would drop a line and let you all know that they work DX up in VK4 too, by heck!

As far as is known at present, VK4HR is out in front, with 95 countries to his list, VK4EL not far back of him with 92, and 4KS has 73 up on the hook, whilst 4RC has 70 scalps to the belt. His best work to date has been a 4½ hour W.A.C. on 14 Mc.

Naturally 14 Mc. is the glamor band at the moment, with lots of nice juicy ones popping through. Some of the "not worked" ones are tit-bits like AC3SS, AC4YN, EP1AL, HZ1AB, XO2G, and HC1FC.

Since 6th October, he has knocked off quite a lot including UA3CA, XZ2KM, UA3KAH, KAEG (Trieste), G6BQ, PA0XE, F8EO, PA0XS, VS9AN, VU2BM, G6WI, G8KP, GW4CX, GW3ZV, VU2FY, VR2AA, CE4AD, VS7JE, GI6TK (operating portable, he was), Y16C, PA0LR, PK1VHN, HB9BS, UA9DP (in Ural Mts.), LU7AZ, CR9AN, XE1A, VQ3HJP, VS2BG, VS4BJ, OZ5HQ, ZS5U, VK4OS (Pt. Moresby), ZS5DU, VR4AA, PK3PL, KP4AN, XAFE (Santa Lucia, Naples Bay), KP6AB (Palmyra Island), UA0KAA (Dicson Is.), VS7GH, HA4EA, ZS6GO, ZS6CC, ST2AM, F3MS, ON4VR, CO2FA, ZE1JI, PK6HA, OZ7UU, CR9AG, YR5X, PK4KS, VQ2GW, ET1JJ, ZK1AA, VS4SR, TF3A, XE1FB, W6WDN/KW6 (Wake Is.), XZ2LY, UI8AA (Tashkent), SM7PY, OZ7HM as well as a fistful of G, W, J, VS1, etc.

Some of the nicest ones before that date included ZD8A, CN8MI, EI9N, OK1FF, KL7AD (on 7 Mc.), VS3-4-5JH, W6ONK (Bikini Island).

He has done a fair bit on 28 Mc., some of which is included in this list. However, it is very patchy there now on 28 Mc. The other night it was coming in like 14 Mc. during a DX contest—but trying to land any of it was another story. 28 Mc. is due for a "renaissance" within the next few

weeks. Has been up on 7 Mc. too, and finds that the old band is still capable of some interesting work. That is if you can get rid of the hash of QRN that surrounds it at present.

4RC's rig is a 6V6 tritet, 807 buffer and 801 final, running 35 watts on the final. Antennas in use are a vertical half wave doublet 14 Mc. and a half wave 7 Mc. matched impedance. Receiver is a revamped model of the Radiotron Junior, with an 1852 R.F. and 6K7 suppressor injected mixer, and 6K7 H.F.O.

## FIFTY AND UP

### VICTORIA

The writer of these notes (3NW) spent a fortnight in Adelaide since last month's notes were written and on his return was very busy for another couple of weeks. Hence the information given here is more the result of questions asked than personal observations and if any interesting data is found to be missing you are asked to overlook the omission!

Between the evening that the two VK7s were heard until the 22nd February, no DX was heard or worked. The whole month proved to be very flat and there appears to be no adequate explanation for this. As the boys say on the other bands "it must be conditions," that nebulous and unknown quantity that presides over the ultimate destiny of all short wave signals. One or two weak signals were heard by 3IZ and 3HK but not identified. On 22nd February a VK7 was heard calling CQ and possibly 3DA but his call was not obtained and signals soon faded out. Predictions indicate a M.U.F. of 49 Mc. for March between Australia and some of the locations to the North, such as Okinawa and we have hopes of working some of these stations. Good work continues to be done in the Northern Hemisphere and we are about due for our share.

Newcomers to the band are as follows: 3HZ (Murray), of Warrigul, who heard several of the portable stations during the last field day and who is running 12 watts to an 807 on 50.16 Mc. with a horizontal dipole antenna. He has worked 3IZ on several occasions and 3HK on two occasions. The latter receives him at R9 and other Melbourne stations should have no difficulty in contacting him. He is located about 60 miles from the city in a nice high position.

VK3AHB puts out a whale of a signal locally from his 813 which runs at 100 watts. However George is not altogether satisfied with the efficiency in spite of the fact that he has inductance tuning in the plate circuit—the 14 odd mmfd. capacity of the tube acting as the plate condenser. His antenna is a semi-vertical

## Bright Star Radio

K. G. ALLEN

VK3UH, Late R.A.N.

Prompt deliveries to all States.

As Illustrated



40 or 80 metre  
AT or BT cut.  
Accuracy 02%  
of your specified frequency,  
£2/12/6

Large unmounted 80 or 40 metre, zero drift cut, £2; mounted 7/6 extra.

20 metre, zero drift mounted £5.

Crystals reground, £1 each  
Taylor Transmitting Tubes  
in the following types  
available soon: T20, T21,  
T40, TZ20, TZ40, T55,  
TB35, 866 JR. Place  
your order now.

Data sheets on request  
Filament, Power and Modulation Transformers made to order. Reasonable Prices



dipole, but materials are on hand for a beam. Pity our receivers then George! Frequency of 3AHB is 50.9 Mc.

3HD in Mordialloc is reported on and 3RO, 3OT, 3LW, 3MV and 3EH are now active. The latter station is running 50 watts to an 807, the complete line up being 6N7 Xtal Osc. (6.3 Mc.) and doubler, 6V6 dblr., 807 dblr., and 807 final into a full wave doublet. Ern is not yet satisfied with his receiver which is a two channel I.F. job using an 1852 and 6K8 in the first converter portion.

Most active on the band appears to be 3YS, 3ABA, 3HK, 3BD and 3IZ, the latter being one of the most regular. Rex runs 25 watts to a T55 at present and is a good contact for Melbourne stations. 3MJ is still very tied up with work but manages to keep in touch with activity on the band by putting in an appearance at weekends.

The field day held on Sunday, 16th February, was the most successful yet held, a feature of the occasion being the excellent relaying of 3WI by 3MJ. A 50 Mc. receiver at 3WI enabled Eric (3BD) to listen in to the portable stations and he broadcast to them via 3MJ. Having the official WIA station operating in this way on the 50 Mc. band was very fine busi-

ness. Stations out were 3IZ near Mornington, 3YS at Macedon, 3HK Mt. St. Leonard near Healesville, 3ABU near Geelong, 3IV Mt. Buninyong, 3ANW Mt. Dandenong, 3WD near Ballarat.

The longest contact was between 3IV and 3HK almost 100 miles and many contacts were made between all the stations. Full details would take too much space to describe. During the afternoon 3AMP, in Colac, heard 3MJ and 3HK we believe, but full details are not yet to hand. 3WC was running continuous tone signals during the afternoon but was not heard by any of the stations. The next field day is to be held on 23rd March, the locations have not yet been arranged except for that of 3ANW which will be Mt. Buller.

Activity on 166 Mc. is gradually increasing. 3NB is now operating there using a pair of HY615s in a linear oscillator and a separately quenched super-regenerative receiver. The writer has contacted him several times and signal strengths are good. 3UJ is also very interested. However most of the 50 Mc. stations are waiting to see how DX conditions on that band go before undertaking much work on the higher frequency. 166 Mc. promises to be well investigated during the winter months. 3NB, 3UJ, 3MB, 3TZ, 3YS and 3NW have all contributed something to the band

and 3KU, 3LW, 3YJ and several others are making plans which should come to fruition soon.

**TASMANIA**

7CW and 7NC have both succeeded in contacting VK2 on this band. Great was the excitement one afternoon when the band burst wide open and QSOs were had by 7CW and 7NC. Congratulations to both of you and we hope to hear more from you in the near future.

**QUEENSLAND**

This will be very easy—the're aren't any. Well more or less anyway because with 50 Mc. dead and only two hardy souls active on 166 Mc. things are only middling. Most of the locals have been tidying up their rigs, and one or two of them have committed the unforgivable sin of doing a bit of operating on 14 and 7 Mc. The QRM on those bands serves to make a fellow appreciate 50 Mc. a bit more anyway.

There is one item worth mentioning in passing and that is that VK4KB made his debut on the band by working VK4XG. No southern signals whatever have been heard, so there is really nothing else to report.

**TECHNICAL BOOK & MAGAZINE CO.**

**297-299 SWANSTON STREET, MELBOURNE**

(Opposite Old Melbourne Hospital)

Central 2041, Melbourne, C.I

We can arrange subscriptions to any of the following magazines:

**AMERICAN.**

RADIO: .....	25/- year	COMMUNICATIONS: .....	24/- year
Q.S.T.: .....	27/- "	RADIO NEWS: .....	32/- "
C.Q.: .....	20/- "	RADIO CRAFT: .....	22/- "
SERVICE: .....	24/- "	SCIENCE DIGEST: .....	23/6 "
F.M. & TELEVISION: .....	48/- "	PROCEEDINGS INST. OF RADIO ENGINEERS .....	88/- "
ELECTRONICS: .....	97/6 "	POPULAR SCIENCE: .....	23/6 "
SPECIAL RATE FOR THREE YEARS: .....	195/- "	POPULAR MECHANICS: .....	23/6 "

**ENGLISH AND AUSTRALIAN.**

WIRELESS WORLD: .....	25/- year	WIRELESS ENGINEER: .....	42/- year
PRACTICAL WIRELESS: .....	13/6 "	ELECTRONIC ENGINEERING: .....	33/- "
AUST. RADIO WORLD: .....	10/6 "	RADIO AND HOBBIES: .....	6/6 "
AMATEUR RADIO: .....	6/- "	SHORTWAVE MAGAZINE (English): .....	25/6 "

Just published by P.M.G.'s Dept.

**LIST OF EXPERIMENTAL STATIONS IN AUSTRALIA.**

2/-d. each; Postage 2½d.

**FOREMOST IN AUSTRALIA FOR TECHNICAL BOOKS.**

## DIVISIONAL NOTES

### NEW SOUTH WALES

Secretary: Peter H. Adams, XV2JK,  
Box 1734 G.P.O., Sydney.

Meeting Place: Science House, Gloucester and Essex Streets.

Meeting Night: Fourth Friday of each month.

The Field Day held at Wyong on Sunday, 26th January, was a success and appeared to be thoroughly enjoyed by the 85 members and friends who attended. First event was the morse receiving contest. A special disc was recorded and presented by the gramophone company. Appearing on the disc was the story with sound effects of a mythical field day, plus five letter code groups. It was some mixture and the winner copied 21 out of a possible 37 code groups. VK2CZ took out the prize of a pair of 807s, presented by Philips. Second prize with 20 code groups copied correctly was won by VK2ZC, who received an 807 donated by the A.W. Valve Co. Other prizes were won by 2NP, thermocouple R.F. meter, donated by Prices Radio; and 2ZC (yes

again), two 5V4G valves, donated by Philips.

The Wyong gang made such a good job of hiding the transmitter that after two hours of operating (on 7 Mc., call sign VK2WI), the transmitter was still undiscovered. The surrounding hills did an excellent job of deflecting and generally scattering the signals. Bearings seemed always to point to some rise or another. It was the first time in Wyong field day history that the transmitter was not found and it looks as if we will revert to either 3.5 Mc. or one of the U.H.F. bands for the next do.

Harry Caldecott (2DA) is acting as State Traffic Manager, in lieu of 2VN, at present in U.S.A.

At the special meeting held on 13th February, N.S.W. agenda items were formulated and these, together with those from other Divisions, will be listed in "Amateur Radio."

The normal monthly meeting will be held on 28th February and Peter Adams (2JX) will lecture on "Modern Battery Design." The record played at the field day will be run and prizes awarded for those that can copy the most code groups.

Congratulations to the VK2 gang that carried off nearly all the prizes awarded in the 1946 Australian DX test. (Roy might have let the VK2s take the lot.) The Newcastle and

Coalfields took out nearly all the sectional prizes, while three Sydney stations won the first three places in the open contest. Dave Duff (2EO) won the test using only a zepp erected the afternoon before the contest started. It was a nice showing for the VK2s.

Some Xtals are to hand from Disposals and further supplies are anticipated, full details of handling will be covered in the "Bulletin."

Don't forget the March monthly meeting on the 28th, when your delegate will be instructed how to vote on the Federal Convention agenda items. Come along and air your views.

#### COALFIELDS ZONE

All that attended the Wyong Field Day voted it a big success and expressed the idea that a lot more should be run along similar lines.

One thing that could be improved in the minds of the Coalfield gang, would be better arrangements for the entertaining of the ladies, while the menfolk are searching for hidden transmitters. Possibly a spot of sport could be arranged. They were generally pleased with the outing and their attendance at future Field Days is pretty well assured.

Conditions generally are patchy, 28 Mc. has quietened down for Europe and 14 Mc. is a mixture of



## LUCK OF THE GAME

Winning the toss is a matter of luck and the cricket captain who calls correctly gains an advantage.

But in the game of life, one cannot rely on one's luck to bring financial benefits—the accumulation of money during one's active working days calls for careful planning.

If we live on less than we earn, contentment will be our reward, and if we have contentment we can snap our fingers at capricious Luck.

*You can't lose by SAVING*

# STATE SAVINGS BANK OF VICTORIA

"WHERE YOUR SAVINGS ARE SECURE"

**AVAILABLE!**  
for **MANUFACTURERS**  
and **EXPERIMENTERS**

# IRC SLIDER TYPE RESISTANCES

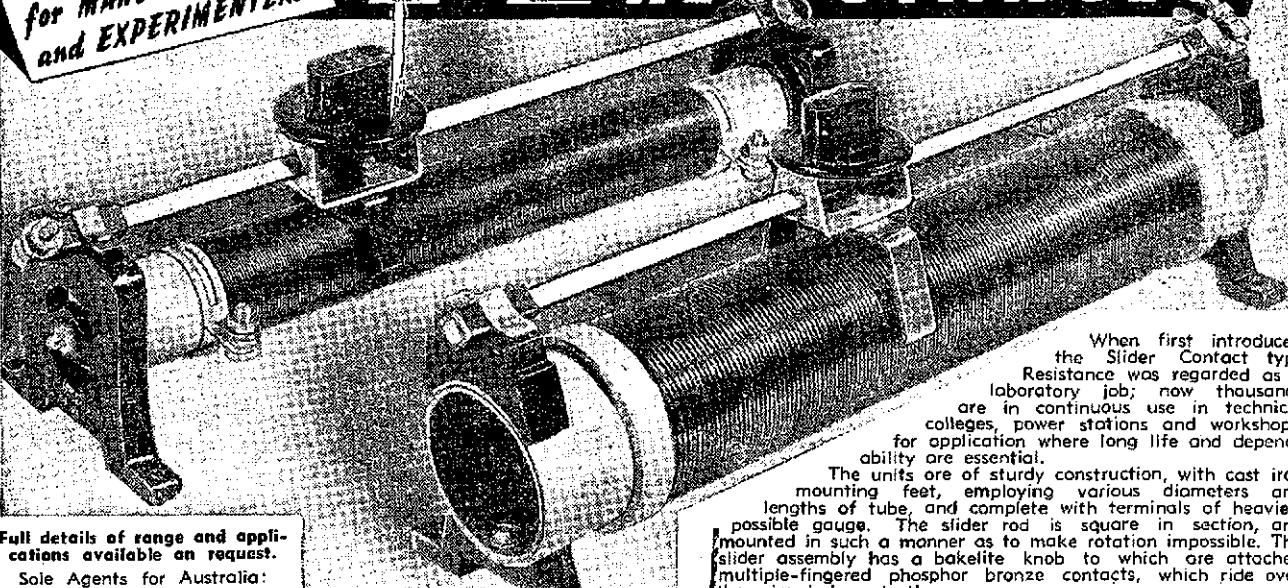

When first introduced the Slider Contact type Resistance was regarded as a laboratory job; now thousands are in continuous use in technical colleges, power stations and workshops, for application where long life and dependability are essential.

The units are of sturdy construction, with cast iron mounting feet, employing various diameters and lengths of tube, and complete with terminals of heaviest possible gauge. The slider rod is square in section, and mounted in such a manner as to make rotation impossible. The slider assembly has a bakelite knob to which are attached multiple-fingered phosphor bronze contacts, which ride over the wire independently.

Full details of range and applications available on request.  
Sole Agents for Australia:

## Wm. J. McLELLAN & CO.

BRADBURY HOUSE, 55 YORK ST., SYDNEY • PHONE BX2508

good and bad days. 7 Mc. satisfactory when QRM permits. 3.5 Mc. will be an attraction in a couple of months.

2TY has not been heard of lately. —...— 2OG, Keith, going strong on 14 Mc., lots of good DX with zepp, and is building a new home in the Maitland district and hopes to settle in shortly. —...— 2YO, George, is active on 14 and 7 Mc. with hopes of going on 28 Mc. Has been experimenting with some earthing ideas. —...— 2XT active again after many years. Bill is on 14 and 7 Mc. Hopes to erect a mast with 28, 14, and 7 Mc. rotary beams. —...— 2LB inactive, often seen building with bits of this and that—that could eventually be a rig eh! —...— 2KZ exclusively on 28 Mc. Max believes in personal chats with local hams and is a sticker for local get-togethers. Telephony doing a good job, and has a rotary under way. —...— 2MK not very active, operating 28 Mc. fone only. Rig is giving trouble at moment. —...— 2PZ is QRL and only gets on at week ends. Has a receiver for the other bands nearly ready and we should hear more of Chris in the near future. —...— 2ADT, Jack, still going strong. DX is piling up, 50 countries on 28 Mc. fone, 80 countries all told. Two sets of half waves in phase on

14 Mc., a long wire zepp for 7 and 3.5 Mc. and the old faithful three element on 28 Mc. W.A.C. while on holidays with 3 watts, nice going. —...— 2YL relaxing after working 101 countries post war, all on 28 and 14 Mc. (nice work Harry). The tally for 28 Mc. is 62 countries, 14 Mc. is 72 countries.

### NEWCASTLE DISTRICT ZONE

There was a very good attendance of Hams from this district at the Wyong Field Day. The work of the W.I.A. executives and the Wyong gang was much appreciated. No doubt some of the boys have given a lot of thought to the question of D/F loops on 7 Mc.

2ZC has not been very active of late. Jim collected two prizes at the Field Day. —...— 2AHA busy with a new rotary. —...— 2BZ doing good work on 50 Mc. and getting nice reports from Wyong and Sydney. —...— 2AMG doing good work with a rotary on 14 Mc., recently burnt out his power supply. —...— 2KB still chasing South Americans on 14 Mc. fone, nice to see him at the Field Day. —...— Ernie, 2FP, still on 28 Mc. and DX no problem with the elevated rotary—much easier than those old spark days Ernie. —...— 2PE has had very nice DX contacts

with his two element rotary from Charlestown —...— 2CS has a receiver going, may be on the air shortly, but still living up to the traditions of the "silent service." —...— Reliably reported 2KG is thinking of coming on again and the bug has also bitten 2JZ. —...— George, 2AGD, very quiet, but busy with new gear. —...— 2LV busy with his transmitter, should be on soon. —...— 2XQ inactive, but hopes all gear to be serviceable for winter months. Quite a few country Hams will concentrate on 3.5 phone this winter. —...— 2HC working QRP fone on 3.5 Mc., but threatened to load up his alphabetical tube (DET1SW) shortly.

### SOUTHERN ZONE

Jim, 2GG, returned from holidays with some bargain gear, ex-disposals. A good receiver is just around the corner. —...— Arthur, 2AP, was in Albury for a few days stopping with 2OJ and he re-sorted his gear after six years. Still in the R.A.A.F. and may not be out until 1948. —...— Dick, 2APW, on the war-path with new receiver with 1900 Kc. I.F.s., but gain disappointing. Worked few on 14 Mc. using 2GG's receiver. Is rather disappointed with lack of co-operation of VKs not answering calls to get reports on his new transmitter.

# A.G. HEALING

LIMITED

MANUFACTURERS AND  
DISTRIBUTORS FOR . . . . .

Electrical and Testing Instruments for all purposes made to British Standard specifications. Each instrument is accurate, + or - , to 2 per cent., and parts are heavily plated to prevent corrosion even under tropical conditions. "Healing" Electrical Meters equal the best imported types and will give accurate service for long periods under the most exacting conditions.

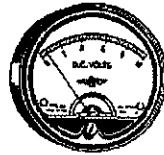

No. 10A round production mounting Black Bakelite Case.

Type No. 30A 4" square semi-flush Black Bakelite Case.

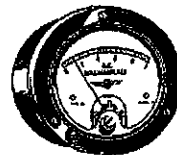
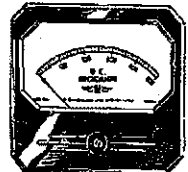

No. 20A 2½" round flush mounting Black Bakelite Case.

These, and all other Healing Radio Electrical Testing Units, are manufactured in our own factories and available from A. G. Healing Ltd.

#### OTHER INSTRUMENTS INCLUDE:

Oscillators — Multi-Testers — Signal Tracers, etc.



ALSO MANUFACTURERS AND DISTRIBUTORS FOR

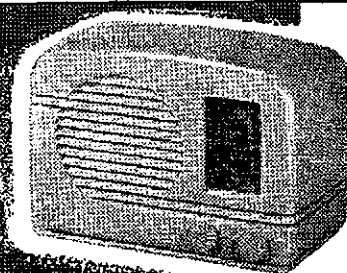

## Golden Voice RADIO

A. G. HEALING LTD., MELBOURNE, SYDNEY, ADELAIDE

—...— Noel, 2OJ, not satisfied with his receiver on 28 Mc. and intends rebuilding with 1852 R.F. and 6K3 mixer. Would like to receive notes from other Southern Zone Hams. QRA: Box 54, Albury. —...— Jim, 2ANQ (ex-3NQ) building a rig and expects to be operating soon.

## VICTORIA

Secretary: A. B. D. Evans, VK3VQ, Box 2611 W G.P.O., Melbourne.  
 Meeting Night: First Wednesday of each month.  
 Meeting Place: Radio School, Melbourne Technical College.

### TECHNICAL ADVISORY COMMITTEE NOTES

Most of the time this month has been devoted to Bush Fire Auxiliary. Reg Bush (Divisional Organiser) and Secretary spent quite a lot of time in the offices of Radio Inspectors and Chief Officer of Country Fire Authority, thrashing out various problems associated with formation of Auxiliary and the allied Rural Scheme. We are pleased to be able to report that by courtesy of R.I., R.A.A.F., and Civil Aviation Authorities licenced amateurs in Victoria associated with the Auxiliary are permitted to use 3492 Kc. and second harmonic 6984 Kc. These frequencies are only to be used for actual emergency communications or exercises under the control of Divisional Organiser. The major value of these frequencies, is the fact that being just outside the lower frequency end of each band, additional capacity, etc., can be incorporated very readily in any rig.

The Chairman of this Committee is the Technical Director of the Division and as such controls the technical policy of the magazine. The Technical Editor being responsible for correlation of information and its publication under the direction of Magazine Editor. The T.A.C. is at present conducting a drive to improve the Magazine technically, and needs your help. Unless the technical articles are sent in by YOU and YOU—well the Committee cannot assist the Technical Editor to fill the Magazine. Don't sit back and leave it to the other fellow. Members of the T.A.C. are doing their best to supply technical items themselves but we feel that there are many members in the Institute, who could, if they applied themselves to the task, provide some very interesting and informative articles. What about it chaps?

Under the heading of Technical Jottings we hope to present some useful information in the form of short paragraphs. Here again your assistance will be appreciated. Shoot them along and we will fix them.

## QUEENSLAND

Secretary (acting): F. Nolan, VK4JU, Box 638 J, G.P.O., Brisbane.  
 Meeting Place: State Service Building, Elizabeth Street, City.  
 Meeting Night: Last Friday in each month.

January was a month of resignations for the VK4 Division, for at the January general meeting, Keith Schleicher relinquished the position of President, while Bob Campbell tended his resignation as Treasurer. A vote of thanks was moved, thanking 4KS and 4RC for their services during troubled times and carried with acclamation.

Bill Argeat then took the chair, and after the usual nominations (and declinations) Arthur Walz (4AW) offered to carry on the job as President, and like-wise Herb. Sprenger consented to keep an eye on Finance. Both of these positions will however be put up for auction at the forthcoming Annual Meeting early in April. I might say that we are hoping for some keen bidding.

For the benefit of country chaps who may not have the dope, we want to advise that Harry Angel operates VK4WI on Sunday mornings for the purpose of passing along the latest and in turn finding out what you fellows have been up to. Time is 1000 and the frequency is 7100 Kc.

### VK4 COUNTRY NOTES

4OK, Jack and George, have given up the QRN band (7 Mc.) and doing FB work on 14 Mc. —...— Charlie (4CU) going great on 7 Mc. Did some nice portable work with 4DQ at Redcliffe recently. —...— 4LN, "The Voice of Gympie,"—Barry uses E.C.O. but still looking for the quiet spot on 7 Mc. band. —...— 4BJ, 4UX and 4PG—the Bundaberg gang—have no trouble with QRM from each other as 4BJ rules 7 Mc., 4UX is the 14 Mc. king, and 4PG sticks to 28 Mc. FB arrangement OMs. —...— 4XJ is a newcomer to Bundaberg. Les puts out nice signals on 7 Mc. New QRM for 4BJ. —...— 4RU (Roy) and 4OW (Lloyd) have started operation from Mackay. Nice CW signals from these boys. —...— 4HZ, the FS6 expert from Gympie, has been very quiet lately. What's doing Jim? —...— 4SN tried several beams. Only one type to go now and that is a W8JK. Getting together some good dope on beams from actual experiment and would like to hear from others who have been experimenting with beams.

No news from the Tablelands this month. What are you doing up there chaps?

# Low Drift Crystals

FOR

## AMATEUR BANDS

ACCURACY 0.02% of  
 STATED FREQUENCY  
 3.5 M/C and 7 M/C.

Unmounted .. £2 0 0  
 Mounted .. £2 10 0  
 12.5 and 14 M/C Fundamental Crystals — Low Drift — Mounted only  
 £5

Spot Frequency Crystals  
 Prices on Application

Regrinds .. £1 0 0

THESE PRICES DO NOT  
 INCLUDE SALES TAX.

**Maxwell Howden**  
 VK3BQ  
 15 CLAREMONT CRES.,  
 CANTERBURY, E.7.

Now that the Christmas holidays are over what about more news from the country chaps? Monthly circulars will be around again ere this appears in "Amateur Radio," so if you haven't got yours let me know. Keep in touch with 4SN by letter or QSO and let him know what you expect in the way of W.I.A. service. Listen to VK4HA on 7 Mc. Sunday morning or contact VK4SN on 7150 or 7080 Kc. fone or CW. VK4HA is on 7100 Kc. approximately.

## SOUTH AUSTRALIA

Secretary: E. A. Barbier, VK5MD,  
Box 1234 K, G.P.O., Adelaide.

Meeting Place: 17 Waymouth Street,  
Adelaide.

Meeting Night: Second Tuesday of  
each month.

A visitor here for the fourth test was Mr. Neil Templeton (VK3HG). With 96 countries in his DX list on 14 Mc. since licences re-issued he has been an interesting Ham to meet personally.

CP1AP, Bolivia, was heard working VK5FL last Sunday, at 1930 hours, and is anxious for VK5 contacts. Frequency is 14010 Kc. and he will be on the air every Sunday evening.

Mr. F. K. McTaggart (VK3NW) was a welcome visitor at the U.H.F. meeting on Wednesday and gave the members present an interesting side-light on VK3 activities.

The Hon. Secretary of the W.I.A. South Australian Division would appreciate the present QRA of ex-VK5SL.

Mr. "Doc" Barbier (5MD) has been appointed delegate to represent VK5 at the conference to be held at Federal Headquarters during Easter.

Several members of the W.I.A. have expressed appreciation of the frequency checks being handled by Mr. F. Wreford (5DW). A number of non-members have availed themselves of this W.I.A. service, and intending new members may secure full information re subscriptions, etc., from Box 1234-K.

VK2ANE (Mr. Eric Sherlock), whose station is aboard the S.S. "Chertsey" at present in Spencer Gulf, has been contacting many VK5 amateurs during the month. Eric is one of the radio officers aboard the "Chertsey" and when off duty operates his amateur transmitter on 14 Mc.

VK5RR has shifted frequency to 7195 Kc. for W.I.A. broadcasts on a Sunday morning at 10 a.m.

It is officially announced that the following are the members of the Advisory Council for 1947: Messrs. E. A. Barbier (5MD), R. V. Galle (5QR), W. L. Pearn (5PN) and J. M. Stratford (5JS).

Mayo Richards (5WR) is recuperating at the Convalescent Home, Magill, and Ted Cawthron (5JE) underwent an operation at Daws Road Military Hospital. Visitors will be welcomed.

Financial members of the W.I.A. are advised that provision is made in the constitution for the readjustment of subscriptions due to hardship, etc.

Written application to the Hon. Secretary will bring full information.

The February monthly general meeting took the form of a screening of technical films dealing with Radar. More than 100 members were present and thoroughly appreciated the films. Mr. John Allan (5UL) made the screening possible, and also gave a short description of the apparatus used in the films. The members present enthusiastically supported the vote of thanks ably proposed by Mr. Roy Cook (5AC). Our thanks are due to the Shell Company for the use of their theatre and the opportunity of viewing Adelaide by night from the roof of the Shell Building.

The attendance at the meeting of U.H.F. enthusiasts held on Wednesday, 29th January, was somewhat disappointing when viewed in the light of the enthusiasm displayed at recent gatherings for U.H.F. boys. Be that as may, those present seemed to enjoy themselves and unquestionably these informal meetings help to bring the boys together and the personal contact helps each "Ham" to appreciate the other's viewpoint. It was unfortunate that the Field Day was handed back to Council with the information that the U.H.F. boys were not prepared to organise anything, as Council are too busy with W.I.A. business to handle such a big thing as a Field Day. The Field Day has now lapsed for want of enthusiasm and the trophies will be disposed of in such a manner as will be decided by Council.

In regard to the Shell Theatre visit, it was not necessary for five members to step out of the lift to make room for me as someone suggested, also when the lift stopped on the second floor by mistake, and everybody marched out like a lot of sheep, why did they blame me?

Noticed Wykeham Bayley looking with awe at the Shell Beacon and he was heard to remark, "What you want is a vertical, Brudder."

Stations heard in VK5 on 14 Mc. this month included HZ1AB, KH6BS, VQ6HOS, CR9AN, XE1CK, PK2AA, C2PL, XAAJ, HB9DU, F4AB, XE1AC, G3BJB, CO6BD, TI2CM, CR7VAL, VS7IS, KA6SA, VS1AE, ZS6BU, U8AA, VS1AM, ZS6CI, SM5UM, I1SV, HA4EA, SV1RX, VQ3HJP, and ZS6HH. On 28 Mc., where conditions have been patchy this month, signals heard included KH6GP, J9AAI, VS1BJ, G2CDI, XZ2GP, F8TU, G4PF, G8IL, VE7EL, TG9JW and W1HEN (Maritime mobile).

VK5HG (Harold Cooper) was heard on 28 Mc. on a recent Sunday, slap bang in the middle of the fone band which, needless to say, pushed him around like nobody's business.

Glad to hear you on again Harold.

Heard 5BZ (Cec. Baseby) working ZL on 14 Mc. There is no doubt about it, Cec's persistence wins in the end. My information came from 5FL who did not tell me whether he heard both sides of the contact!

It must have been gratifying to Council and the retiring President to hear the spontaneous vote of appreciation to 5IT given by the members at the general meeting. Members of the Council, who can be pardoned

### VK3NU

## Major Radio & Electrical Co.

189 GLENFERRIE ROAD,  
MALVERN

WM 1814 U 9354

**SPECIAL !!**

**METER SCALES**— Suitable for "Disposal" Pullin meters. Two types, Volt-M.A.-Ohm and Valve and condenser tester. 2/- each, Post Free.

**CHASSIS, RACKS, PANELS**

We specialise in chassis and panels to your specifications. Write, enclosing full particulars, for a quotation.

**TRANSFORMERS.**

**Multi Match Modulation Transformers.** 75 watt, mounted in die-cast metal clamps. Write for full specifications, £4/19/6. Prompt delivery.

**Power Transformers** — Wound on extra large core of highest grade stalloy. Any voltage or wattage. Reasonably priced with short delivery period.

at times for thinking that the great amount of work which they shoulder is perhaps not appreciated, probably will now realise that the average Ham is quite undemonstrative as a rule, but does at all times appreciate the good work on his behalf. The resignation of Mr. I. Thomas as President, is a blow to members and Council alike, but business reasons do not permit any reconsidering of the decision on the part of "Tommy." Anyway the best of luck to you and thank you for a job well done for amateur radio.

Mr. Hal Austin, M.I.R.E. (Aust.), ex-5BN, the newly appointed president is undoubtedly the right man for the job. Educated at Pulteney Grammar School, St. Peter's College and five years in the employ of the Municipal Tramways Trust fitted him for a position with Adelaide Radio, an electrical and radio firm which had the foresight to see the advantages of the new wonder "broadcasting." Hal's broadcast on Friday nights of Gilbert and Sullivan records was the highlight of early radio. Launching out for himself in the radio business, he established the present position he now holds in the radio trade. He realises fully the hard task ahead following in "Tommy's" footsteps, but with the loyalty of members and Council, Hal will face the future with confidence.

5CA, whose QTH is Darwin, has been heard on 14 Mc. with phone signals of good strength late at night. Attached to the interim R.A.A.F., he is coming home to Blackwood in the near future, and is looking forward to meeting some of his VK5 contacts personally.

The half hour ruling on QSOs came up for discussion at the last general meeting and seldom has such a unanimous decision been arrived at. The meeting decidedly agreed that the present ruling is a good one and that no attempt should be made to alter it. It is realised by all that no attempt has ever been made to interfere with genuine tests or discussions but that idle chatter during DX times, etc., must be controlled.

The programme side of the general meetings in VK5 has reached an all time high lately, and Council must be hard put to maintain the high level.

#### TUBE HEATER CIRCUIT OPEN

Before discarding tube try applying hot iron (soldering type) to the heater pins. Dry joints occur even in tube pins. This fault has been experienced mainly with 866 rectifiers.

## TASMANIA

Secretary: J. Brown, VK7BJ  
12 Thirza Street, New Town.  
Phone W 1328.

Meeting Place: Photographic Society's Rooms, 163 Liverpool Street, Hobart.

Meeting Night: First Wednesday of each month.

The general meeting was held on Wednesday, 5th February, at 8 p.m., and those present were 7LJ (in the chair), 7BJ, 7OM, 7CT, 7CJ, 7TR, 7RF, 7CW, 7MY, 7LE, 7ML, 7GR, 7RY, 7DW, 7AL, 7DH and Messrs. Allenby, Fulton, Brown, Durkin, Lipscombe and Watson (2). Apologies were received from 7FA and Mr. Koglin. The general business was handled in the usual expert style and among other things the correspondence regarding the proposed regulations of the Australian DX Century Club came in for a lot of lively discussion among those present. The pet hobby horse was the part where QSLs were needed as a verification of the authenticity of the claim. One old hard-head was heard to remark, "Yeah, I've lost 'em like that before!!!" Oh well, we'll see.

It would appear that the VK6 gang are trying to educate their local politicians! What an undertaking. It appears that a couple of the local Senators visited a local shack, under guard, and were astounded at what went on—even professed complete ignorance in Amateur Radio generally! How many others of the clan are the same way?

Four more new members have been added to our list and comprised one full member and three associates. They were Len Edwards (7LE) and Messrs. D. H. Watson, M. J. Watson and O. L. Brown. Welcome, and pleased to meet you all.

Quite an amount of voice was given to the growing prevalence of the useless ragchewing which is growing in the recognised DX bands. It's quite a common occurrence to hear a short cross-town QSO in the middle of what would be a decent DX session. Excuses can be held for legitimate tests, but for some of the rot that is exchanged—well.

Another bone of contention is the indiscriminate use of the V.F.O. Several of the local lads have had excellent DX QSOs broken up by some band-hog who hears a bit of juicy DX on the air working someone and will deliberately—yes, I say deliberately—shift their rig right on top

of the DX and proceed to call him. Does this show that the Amateur game is degenerating or is it through lack of thought? I wonder.

A very FE Field Day was held one sunny Sunday just recently and judging by the amount of bouquet slinging, the gang had a really excellent day. QTH was Snug Beach. "Doc" Kelly (7LL) was the xmitter party—he's almost a party, you should see his waistline—!!! and made an excellent job of locating the rig.

## Australia's Largest Stock of All Radio Components

Chokes  
Coils  
Condensers  
Dials  
Intermediate Transformers  
Mose Equipment  
Potentiometers  
etc., etc.  
Resistors  
Soldering Irons  
Speakers  
Test Equipment  
Valves  
Pick-Ups  
Power Transformers  
etc., etc.

Obtainable from

## Bloch & Berber Ltd.

with which is associated  
the

### WELDON ELECTRIC SUPPLY CO.

46-48 YORK STREET,  
SYDNEY

G.P.O. Box 2282 M

Phones: MA 6291 (10 lines)

as most of the lads were tricked by spurious bearings from a local pile at Electrona.

7CW was first to locate the rig, but as he had not complied fully with the rules, he declined to take the honours. Honesty is the best policy eh, Crosby? 7BJ was second in, in the "Red Terror," and copped the prize. By the way, what was the prize Joe? 7LJ and 7TR were teamed and were third on the scene, after 7TR had left a lump of his hide on

an old stove somebody had dumped. Too old even to step over a heap of junk eh, Ray. Congrats to the place getters and to all those who joined to make the day so very enjoyable.

A meeting has been arranged with the Northern Gang to take place on the 22nd of February at Launceston. A bumper meeting and a good trip is expected by the local gang. Plenty of pubs along the road too!

We will be ably represented this year at the Annual Convention by our worthy Secretary, 7BJ. He is also Federal Councillor for VK7, and therefore, should be well equipped to do justice to the big job ahead of him. Good luck Joe.

It was decided to hold another Field Day on Sunday, 16th March, with the same rules applying. In this instance 7AL is to have the Xmitter and is working hard on a decent location to keep the wolves out. See you at the Field Day.

To wind up a very successful meeting we were regaled with a few anecdotes on his experiences during his war service by 7LE (L. Edwards) who was with an A.B.C. unit. He had quite an amount of interesting Japanese gear, most of which caused the boys to open their eyes and to wonder whether they would be able to secrete any of it from the alert eyes of the owner, Len. Many thanks OM. By the way, 7BJ is looking for the next lucky victim—who will it be? Have your answer in to the Secretary at least 7 days before the next meeting and see what happens to you!

#### MODULATION CHECKER

These figures are given on the assumption that there is negligible distortion in the A.F. voltage taken from the last stage in the speech amplifier; also that the phase shift between the A.F. voltage and the voltage modulating the R.F. amplifier, is negligible. The R.F. voltage is obtained by a pick-up coil consisting of a couple of turns of wire. This coil is placed near either the modulated amplifier tank coil or near the aerial coupler.

About a 50 volt amplitude is required for the audio or R.F. voltage to give a satisfactory deflection on the screen of the oscillograph. It is IMPORTANT to turn the INTENSITY control back to zero before the voltage is removed from the deflecting plates, otherwise a spot may be burned on the fluorescent material of the screen.

#### DIRECT DISC RECORDING

traversing mechanism whereby the pivot about which the cutting head pivots in a vertical plane can be raised or lowered slightly, relative to the disc, preferably by means of a screw. In this way, small variations in the cutting angle can be effected while cutting is in progress.

The second adjustment has a large effect on the ease with which the swarf is controlled. The requirement is that it be thrown well clear of the stylus as it leaves the disc, after which its natural shrinkage will cause it to gather in a tidy circle just inside the track, as mentioned earlier. The shrinkage effect is normally not sufficient to do this, and there is the need to introduce a slight angular "bias" on the stylus cutting face to bring about the "throwing" effect. Rotating the stylus slightly in the chuck of the cutting head would be a possible way of doing this, but it is a clumsy method and difficult of fine adjustment. In any case it is usually foiled by the presence of the clamping "flat" on the shank.

A far more satisfactory way is to advance the cutting head slightly, relative to the traversing mechanism, so that instead of the stylus travelling along a true radius of the disc when moved by the leadscrew, it moves instead along a parallel line slightly forward of it. The amount of forward advance required is between  $\frac{1}{4}$ -inch and  $\frac{1}{2}$ -inch, depending on the maximum diameter of disc to be used, and its speed of rotation, and can best be determined by trial. This slight departure from the theoretically correct condition makes no detectable difference in the groove shape, or in the quality of reproduction.

The term "Point Feeling" has been coined to describe a habit that some recordists have of determining the existence of modulation at the cutting head by touching the stylus tip with the fingers. The practice is to be deprecated, as apart from the risk of accidental mechanical damage to a sapphire, the presence of perspiration on the fingers can dull the cutting edges of a metallic tip. If done at all, only the lightest of pressures should be used against the front of the stylus shank, and not the actual cutting surfaces.

The final chapter in this series will deal with some aspects of the various discs used for Instantaneous Recording.

# GLO-RAD

**ADVISES C.W. OPERATORS** to employ peaked audio amplifiers as a means of improving signal to noise ratio and increasing selectivity of B.F.O.

Select your peak with switch, adjust B.F.O. for maximum response, — change note at will.

Reactors and Transformers for both "Clipper" and "Peaked Stages" available. PRICE 20/- plus Sales Tax

Please add postage and exchange to country orders  
MAIL your Order NOW

**Glo-Rad Engineering Services**

Box 2147T, G.P.O., Melb.

PHONE: WX 3440

## FOR SALE, EXCHANGE, WANTED

3d per line. Minimum 2/-

**WANTED \$15 VALVE** or Valves. Particulars, price, etc., to E. Carruthers, 55 Alexandra Street, Hunters' Hill, Sydney, N.S.W.

**SELL VALVES** types 954, 9001, 6AK5, etc., 15/-. Philips a.c./d.c. series 10/-. J. Radclyffe, 60 Elimatta Street, Bradon, Canberra.



# TAMING AN 807 . . . THIS COULD HAPPEN TO YOU!

By C. G. HARVEY, VK3UO\*

This is some of the story of the first trials of a beam pentode at VK3UO. Just before the war, there was ample reason to believe that the day of the easy to drive medium power R.F. tube was approaching. For instance, the old 6P6 looked a good thing until displaced by the 6L6G, in its turn to be displaced by the 807.

War saw the large scale practical employment of the beam tetrode, probably because of the need to reduce not only transmitter size and weight, but to build them in the fewest possible man-hours. Some of these transmitters, as we know to our cost, were dismal failures, others were honeys.

The fact remains that several countries in the world produced one or more successful transmitters in which

beam tubes like the 813 or the 807 did a man-sized job.

Any Ham that had dealings with these transmitters could hardly have failed to want to polish up the circuits, raise the efficiency, put up a decent antenna, with a decent coupling system on the end, and see what would happen. The promise of a reduction in cost per watt for this ideal, appears just the thing for the inflated pocket, and the promise of a match-box sized transmitter instead of a 6-foot rack and panel may be some of the reason why so many Hams today are using the beam tubes.

Many articles have been written about these tubes and their peculiarities. Nevertheless, attempts by the uninitiated to resolve the enthusiastic propaganda and the complaints of the dissatisfied, is a problem that is unlikely to be solved easily without a fair technical background, a large Junk Box and a good hints and kinks department.

For those of you who have been able to make beam tubes do just what you wished first time on, this article is not for you. To the embryo Ham just starting off to work the world on low power and cost, there will be food for thought.

Before the war had really finished we had, like most other pre-war Hams, thought deeply about the first new rig, the underground couldn't confirm just what bands were going to be open first, so we built a 3.5 Mc. oscillator, ground a few appropriate Xtals, and then hotted up a decent all-band superhet. This was completed in time for the opening of 14 Mc., and by this time we had read a considerable amount of literature in search of gen on the beam tetrodes. In particular we had looked high and low for the dope on 807s because it was this tube that we had selected as the first post-war guinea pig.

Our first mistake was to consider that they would be really easy to drive as a P.A. In our innocence, we had thought that 3 mills, drive from an oscillator would be easy on 14 Mc., and any way if these tubes were as easy to drive as was thought, it wouldn't matter much anyway.

Symptoms such as uneven output near resonance, poor note, erratic screen current and a tendency to produce watery joeys finally changed our minds.

\*Flat 7, 13 Hughendon Road, East St. Kilda.

## "RED LINE" AMATEUR TRANSMITTING GEAR

High Tension Plate Supply Power Transformer 1500/1500v at 125 M.A.

Filament Transformer High Tension Rectifier 2.5v. C.T. 10A.

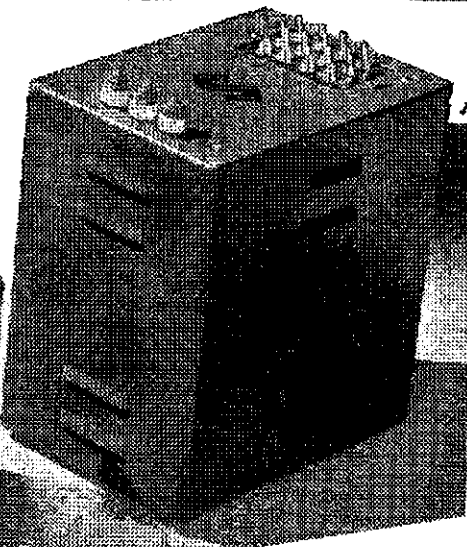
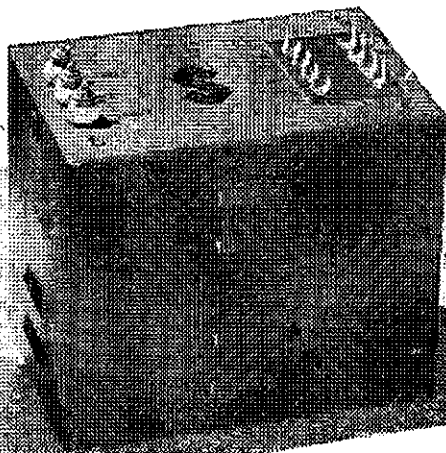
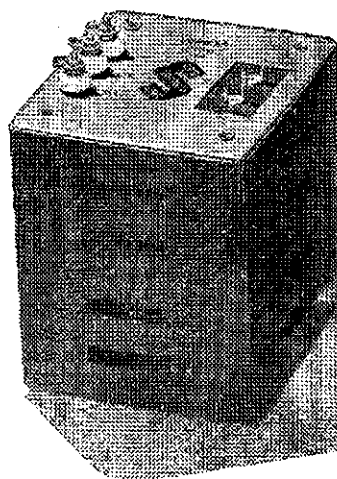

High Tension Plate Supply Power Transformer 2000/2000v at 200 M.A.

Technical Service,  
Wholesale and Manufacturers  
A. T. SWALES  
2 Coates Lane, Melbourne  
Cent. 4773.

Available from  
**SWALES & SWANN**  
and Leading Distributors in all States.

Trade Sales: Allen SWANN,  
157 Elizabeth Street, Melbourne.  
MU 6895 (3 lines)

To go back a stage, being pre-war E.C.O. fans, we had hoped to be able to drive the 807 direct from a simple E.C.O. with the grid on 7 Mc. and the plate on 14 Mc. We weren't going to spend money on meters unnecessarily and in any case the transmitter had to be small enough to stow away in a wardrobe in a flat. The new E.C.O. went along nicely with its plate supply obtained from the receiver. There was a separate 350 volts for the 807 plate supply and the 807 screen voltage was to come from the receiver supply.

Being a confirmed triode fan, we didn't place too much importance on articles stating that screen current was an important factor, and consequently we didn't provide a separate screen current meter.

We soon changed our tune though, when we found the off resonance plate current a bare 45 Ma. and the resonance current at no load 20 Ma. The investigation revealed that although screen current is reasonably steady, it rises at resonance, and unless the meter is arranged to read plate current alone, a false idea of the efficiency of the tank circuit can be obtained. (About this time we discarded the venerable pea lamp as a tuning indicator in favour of meter switching, and have never regretted the change.)

The corrective action in this case was to increase the screen current by raising its voltage, the conventional resistor from the plate supply did the trick, raising the screen current to 8 Ma. which is close to the maker's tolerance.

The thing to watch here is that no matter what conditions of tuning or loading apply, the screen current must not be exceeded, if it is you will finally lose your 807 in a blue glow like your YL's eyes and just as expensive.

The standing current off resonance now appeared much higher, in the vicinity of 80 Ma., and the resonance dip was more normal. Full of confidence however, we kept the grid current down to 1 Ma. under load and expected the world to answer the first CQ. It didn't.

About this time we had troubles with the note, which seemed OK unloaded. (Eventually we tracked this down to transformer lamination vibration, but not before a considerable amount of soldering, shielding and searching for additional filter chokes and condensers had gone on.) Our QSOs had not been numerous and the decision to increase the 807 plate voltage to its rated value was made.

Nothing much happened except that the keying tube got red hot, the 807 got red hot, and the note was worse. The QSOs were still VK and ZL. Then the coupling condenser (a mica one of a well-known brand) passed on, so we tried tuned grid input and very quickly discarded it.

We thought we knew some of the

trade secrets of operating 807s because we had the proverbial 50 ohms in the screen, we had sunk the tube socket well below the aluminium panel on which the whole transmitter was built, we had kept grid and plate leads short and well away from one another, all the by-pass condensers came back to a common point or points, the filaments were by-passed and the whole oscillator was shielded including the tube.

The trouble however, wasn't always parasitics, but often showed up as jerky plate current dip at resonance and a poor note. Tuning was made difficult with this 550 volts on the plate because of the tube reddening up and the consequent risk of running it soft. In particular, joeys appeared when ever tuning was attempted without any type of load.

About this time we began to think that 807s were the fiendish design of a sadistic R.I. who hoped to make one stick to the terms of his licence and really do a bit of experimenting. Our dreams of a small, cheap, efficient, low power transmitter were vanishing as we juggled shielding and by-pass condensers without avail.

A bit of thought and a re-check on some of the articles revealed the fact that most were using relatively high voltage on their Xtal oscillators and some had even seen fit to add a pea lamp in the Xtal circuit! This raised the doubt that our 1 Ma. of drive might be the root of our troubles. Accordingly, up went the oscillator voltage to 350 volts, down went the cathode tap and the grid resistor, and the 807 grew cooler. The note stayed rough so we tried some more and yet some more filter without avail.

The only trick in the bag seemed to be to raise the drive to the manufacturer's figure. "Who knows, 2 mills. isn't much and it may just do the trick!" Accordingly we relegated the 45 keyer tube to an odd corner, substituted the BCL 42 as a doubler, put the E.C.O. grid on 3.5 Mc. and the plate on 7 Mc. and presto a nice resonance dip and a cool 807, tons of R.F. in the tank, but still a poor note. This was improved a little by adding 8 mfd. right at the 807s screen.

Difficulties in obtaining suitable 600 volt working filter condensers precipitated the decision to go Xtal temporarily, and presto, the note improved a little more. We traced the original poor note to an almost imperceptible transformer lamination vibration when the key was down, and this also affected the joeys when they were present.

Many of these problems apply in part to normal triode transmitter P.As., but in our opinion after 12 months rebuilding and experimenting, any one of the following factors could put you off 807s for life, for example. We believe that . . .

\*Less than 3 Ma. grid drive is asking for trouble in a P.A.

- \*More than 9 Ma. screen current under any condition of tuning will finally cost you a new 807.
- \*A red plate may mean insufficient drive, and a red hot screen.
- \*The upper limit of plate loading is flatter than in a triode, consequently it is harder to exceed the rated plate dissipation. The screen suffers instead if you load the tank too hard.
- \*Don't fail to shield the tube up as far as the base of the elements, and in addition keep the driving stages beneath the metal chassis too. Bread-board layouts are best left to triodes.
- \*Don't plan to fit V.H.F. parasitic chokes unless all else fails. If proper construction methods are used they will not be necessary.
- \*Try and use decent insulation in the plate tank circuit and keep the efficiency, and Q, up.
- \*Invest a few bob in a meter and selector switch, it will run out cheaper than 807s and pea lamps.
- \*Watch the grid coupling condenser, because it is likely to lose its life when decent T.P.T.G. type oscillations start.
- \*Don't try and use tuned grid input circuits to the 807, they seem to be a prize source of T.P.T.G. type oscillations, which nothing sensible seems to cure.
- \*Transformer vibration may produce a typical poor note, particularly where there is a tendency to self oscillation. If you use E.C.O., keep the transformers away, or use solid anti-vibration engineering.
- \*Don't be surprised to get joeys when the plate is unloaded, if everything is in order, they will disappear when a little load is coupled on.
- \*Don't try and neutralise the beast, start right in rebuilding a sound shielded outfit with short leads and cancelling coil fields.
- \*Don't waste time trying to grid key the tube. Screen or cathode is simple and effective.
- \*Don't blame me if your 807 writes "nurts" in lovely blue ink on its envelope.

#### THE BASIC CIRCUIT VALUES NOW:—

	Tritet	Dblr.
Plate By-Pass	.001	.01
Screen By-Pass	.001	.001
Grid Coupling	—	.0001
Screen Dropping	100,000	75,000
Grid Resistor	30,000	50,000

	P.A.	Keyer Tube
Plate By-Pass	.01	.001
Screen By-Pass	.001	—
Grid Coupling	.00025	—
Screen Dropping	40,000*	—
Grid Resistor	30,000	—

\*Adjusted till maximum of 8 Ma. flows.



For the  
Amateur  
Broadcaster

The Widest Possible Range in Town!

**RADIO  
Parts**

Most hams agree that there is nothing to equal the variety and quality of radio parts now being offered by L. & H. and their retailers.

Ask your broadcasting pals about L. & H. equipment — see for yourself! The unsurpassed performance of all L. & H. components is known all over Australia—guaranteed thoroughly efficient, reliable and built for years of quality service.

Check up on your requirements now! Let this list help you—

MICROPHONES  
COILS  
BATTERIES  
METERS  
SWITCHES

VALVES  
VIBRATORS  
TRANSFORMERS  
CHOKES  
CHASSES

CONDENSERS  
SPEAKERS  
RESISTORS  
LINEFILTERS  
Etc., Etc.

Helpful technical advice readily given upon request. Obtain latest lists and prices from your radio house.

**Lawrence & Hanson Electrical** PTY. LTD.

33 YORK STREET, SYDNEY  
87 ELIZABETH STREET, BRISBANE  
120 COLLINS STREET, HOBART

172 WILLIAM STREET, MELBOURNE  
60 WAYMOUTH STREET, ADELAIDE  
20 PATTERSON STREET, LAUNCESTON

## THE AEGIS 'LITTLE COMPANION'

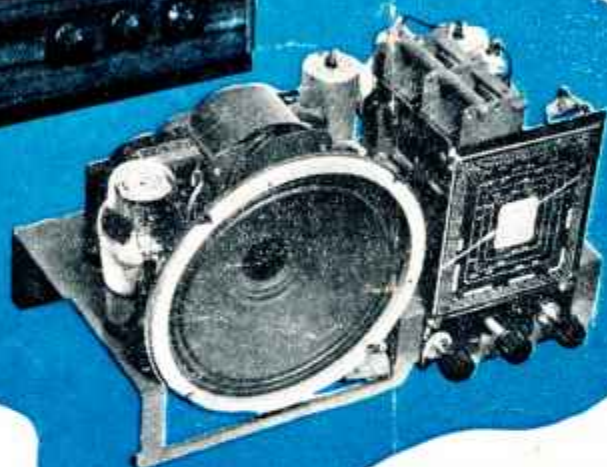

**YOUR**  
*Favourite*  
**KIT ASSEMBLY**  
*has been Streamlined!*

**FEATURES**

- \*DUAL-WAVE
- \*ROLA SPEAKER
- \*PERMEABILITY IRON-CORED B/C AND S/W
- \*PERMEABILITY IRON-CORED INTERMEDIATES
- \*SUPER NEW CABINET
- \*DUCON CONDENSERS, Etc.

Add the latest, smartest, professional touch to your new radio with the modern streamlined wooden cabinet now supplied with the popular Aegis Little Companion. It is a 5-valve 2-band receiver A.C. operated, complete to the last nut and bolt, with full easy-to-build directions.

**AEGIS**  
 MANUFACTURING COMPANY PTY. LTD.

208 LT. LONSDALE ST., MELB.

DISTRIBUTORS IN ALL STATES

# AMATEUR RADIO

APRIL  
1947

JOURNAL OF THE WIRELESS INSTITUTE OF AUSTRALIA

## An indispensable instrument for the experimenter

To the experimenter the Philips "Philoscope"  
(A.C. Bridge) Type TA 160 offers seven  
major features.

- 1 The accuracy is unimpaired by mains voltage fluctuation.
- 2 A calibration system has been incorporated enabling rapid checking of the apparatus at any instant.
- 3 The highly sensitive magic eye indicator facilitates precise balancing of the bridge circuit.
- 4 The sensitivity of the indicator is variable. This is very helpful when measuring components of an unknown value.
- 5 It is not possible to damage the instrument by overloading the indicator or by faulty connections.
- 6 The maximum voltage applied to test components is 3V., or in the case of low resistances, the maximum current is 500mA.
- 7 The apparatus can be operated from 220V., 240V., 260V., 40/50 cycles mains supply.

We will be pleased to supply you with further details on request

# PHILIPS

## PHILOSCOPE TYPE T.A.160

PHILIPS ELECTRICAL INDUSTRIES OF AUSTRALIA PTY. LTD.  
SYDNEY : MELBOURNE : ADELAIDE : PERTH : BRISBANE



FOR THE EXPERIMENTER & RADIO ENTHUSIAST

Registered at G.P.O., Melbourne, for transmission by post as a periodical.

6d.

KKI

## THIS IS THE FAMOUS FERROTUNE FOUNDATION KIT



**K**INGSLEY RADIO brings all amateur self-builders a FOUNDATION KIT that makes any predecessors completely out-of-date. The FERROTUNE FOUNDATION KIT is based on the revolutionary IRON-CORE TUNING which KINGSLEY developed during the war years.

FERROTUNE brings you greater clarity of reception, faultless tuning of every broadcast frequency, increased coil I.F. gain and selectivity. Included in the FERROTUNE FOUNDATION KIT is . . .

1. The outstanding FERROTUNE ferromagnetic gangless tuning unit—it covers the broadcast band and includes tuning mechanism, straight line dial, padding and trimming, etc. It does not need further alignment.
2. Cadmium-plated steel chassis.
3. Two PERMACLAD I.F.'s which have exceptionally high "Q" ratings.
4. Complete attractive plastic escutcheon with glass window.

OBTAINABLE FROM  
AUTHORISED KINGSLEY DISTRIBUTORS

Ask your radio dealer for

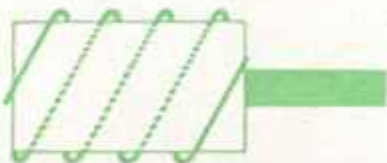

**F E R R O T U N E**  
FERRO-MAGNETIC IRON-CORE COILS, I.F.'s AND  
GANGLASS TUNING UNITS



# KINGSLEY RADIO

KINGSLEY RADIO PTY. LTD.

380 St. Kilda Road, Melbourne, Victoria . Phones: MX 1159, MX 3653

APRIL — 1947

Vol. 15 No. 4

# AMATEUR RADIO

Published by The Wireless Institute of Australia,  
Law Court Chambers, 191 Queen Street,  
Melbourne, C.1

**Editor:**

T. D. HOGAN, VK3HX.  
Telephone: UM 1732.

**Technical Editor:**

J. K. RIDGWAY, VK3CR.

**Notes Editor:**

R. W. HIGGINBOTHAM, VK3RN.

**Distribution:**

H. N. STEVENS, VK3JO.

**Business Manager:**

J. G. MARSLAND, VK3NY.

**Advertising Representative:**

W. J. LEWIS,  
20 Queen Street, Melbourne, C.1.  
Telephone: MU 5154.

**Printers:**

H. HEARNE & CO. PTY. LTD.  
285 LaTrobe Street, Melbourne.

MSS. and Magazine Correspondence should be forwarded to the Editor, "Amateur Radio," Box 2611W, G.P.O., Melbourne, on or before the 15th of each month.

Subscription rate is 6/- per annum, in advance (post. paid).

— IN THIS ISSUE —

V.H.F. Antenna.....	3
Clearing the Ether.....	4
Story of the Decibel.....	8
"Such Nice People".....	11
Q.S.L. Bureau.....	12
Federal Notes.....	12
Rambling on the DX Bands.....	14
Divisional Notes.....	17

## EDITORIAL



The Federal Convention, to be held in Melbourne at Easter, has before it an Agenda of far reaching importance to the W.I.A. The Agenda items submitted by the Divisions cover a wide field and, when viewed in relation to the matters reviewed at the 1946 Convention, survey the whole gamut of post-war amateur activity. The last Convention concentrated in the main on the Regulations by which Amateur Radio is governed in this country, and it is of interest to note that of the matters which the 1946 Convention directed the Federal Executive to negotiate with the P.M.G. Department, 86 per cent. were agreed to and 5 per cent. are pending the final result of negotiation. A complete statement on this subject will be included in the next issue in the report on the 1947 Convention.

The major effort at this forthcoming Convention will be concentrated on improving and consolidating the Federal machinery of the W.I.A. to suit present-day conditions. Adequate provision has been made, however, for examining technical development planning, the current situation on P.M.G. Regulations, the setting up of a Defence Radio Reserve and other important matters.

One aspect of Federal W.I.A. administration that will receive

special consideration concerns the heavy volume of work associated with running the Federal affairs of the Institute, including the onerous task of publishing this Magazine. It represents a burden beyond which any one Division should reasonably be called upon to carry. There is agreement generally that the time has arrived when serious consideration must be given to providing a full-time paid officer of the W.I.A. The practical problems associated with such an appointment will be an important subject of deliberation by the delegates.

As the Agenda of the Convention contains items of such importance to each Division, it is extremely gratifying to see that each will be represented by its own Federal Councillor. Although the cost of transportation represents over 1/3 per full member, it is only by bringing together the various Divisions' own spokesmen, each capable of presenting his States' views and opinions on the wide range of subjects concerned, can we possibly hammer out a policy along sound democratic lines which can guide us during the forthcoming year to the benefit of the Australian Amateur and his hobby.

V. E. M.

# HOMECRAFTS

# THE RADIO SPECIALISTS

290 LONSDALE STREET, MELBOURNE  
100 CLARENCE STREET, SYDNEY

A BARGAIN FOR HOME SET-BUILDERS

## THE GRAEME A.C. Mantel Kit Set

4 NEW TYPE VALVES  
REFLEX SUPER-HET CHASSIS  
8 INCH ROLA SPEAKER  
STREAMLINED PLASTIC CABINET

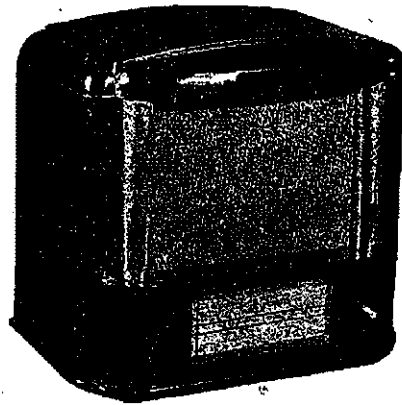

Complete, Ready to Assemble, A *BARGAIN* at £14/19/6

### 5-WATT PORTABLE AMPLIFIER

EXCLUSIVE TO HOMECRAFTS. A PERFECT  
UNIT FOR DANCE BANDS, PARTIES OR HOME  
RECORDING. COMPLETE with VALVES,  
MICROPHONE and CARRYING CASE £27/5/-

#### Radio and Electrical Specials:

LUCAS Army Spotlights . . . . . 35/-  
TRUTRAK Electric Pickups . . . . . 37/6  
CAPITOL Mike with transformer 17/6

REMOTE CONTROLS for interhouse  
Phones, £2/2/0.  
PEERLESS 1/16 h.p. Electric Motors  
£4/5/0  
GRAMO MOTORS WITH PICK UP IN  
PORTABLE CASE, £17/17/0

WRITE FOR NEW 1947 CATALOGUE. SEND 9d. TO COVER COST & POSTAGE

## HOMECRAFTS PTY. LTD.

MELBOURNE: Head Office, 290 Lonsdale Street. BALLARAT: 307 Sturt Street. GEELONG:  
132a Moorabool Street. SYDNEY: 100 Clarence Street. NEWCASTLE: 26 Hunter Street.  
HOBART, LAUNCESTON and BURNIE, TASMANIA.



# V.H.F. ANTENNA

By E. C. MANIFOLD, VK3EM\*

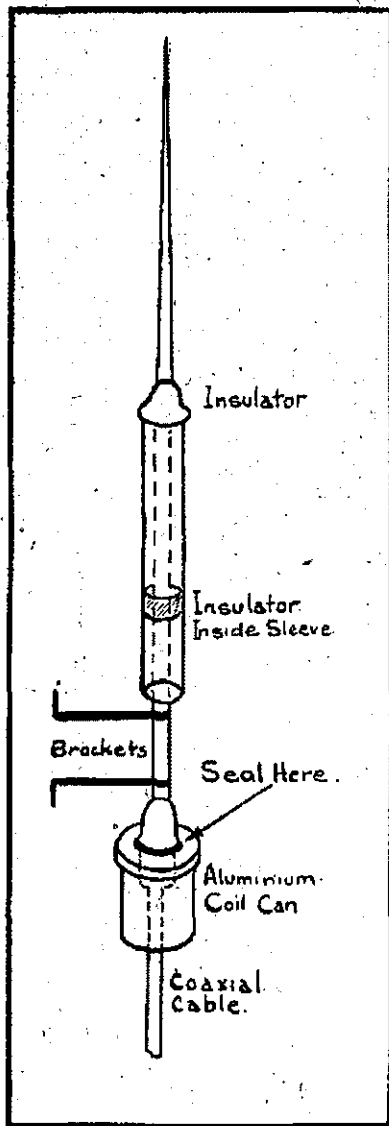

With the V.H.F. channels coming more into use by the amateur fraternity and the availability at present of co-axial cables fairly cheaply, brings a few rather serious thoughts to hand as to how to make use of various cables with different surge im-

pedances; 55, 75 and 80 ohms to name some of the more common ones at hand.

Most of us make a few notes; many attempts at working things out, and finally finish up by saying—well, the mis-match won't be too bad, I hope!

As a basis for getting fairly close to the mark, the following notes are submitted, and while many chaps are perhaps capable of working out all their own problems, this does not help the other chap solve his, so you ex-Radar chaps who did have some experience in V.H.F. aerials, etc., let's have more of these notes and extend the knowledge of all concerned.

These notes deal with the use of the matching stub as a means of coupling the co-axial cable to the radiator.

### Characteristics of Transmission Line

$$Z_0 = 276 \log 10 \frac{D}{r}$$

where  $Z_0$  = impedance in ohms.  
 $D$  = distance between centres of elements.  
 $r$  = radius of elements (not diameter).

The above is a common and well-known formula, and holds only when the spacing is large relative to the diameter; the most usual condition in general applications.

### Line Velocity

Two wire open line— $V = 0.975$ —  
 for other types of transmission line— $V$ —can be found in most handbooks, as can most of the other accompanying formula.

### Length of Line

$$L \text{ (inches)} = \frac{2952 \times V}{\text{Freq. Mc.}}$$

where  $L$  = length in inches.  
 $V$  = line velocity constant.  
 To obtain a half wave or full wave section multiply by 2 or 4 respectively.

### Quarter Wave Transmission Line

To match the co-axial line ( $Z_1$ ) to the radiator ( $Z_2$ ), the impedance of the line ( $Z_0$ ) will be—

$$Z_0 = \sqrt{Z_1 Z_2}$$

### Attenuation

Some co-axial cables handled by W.I.A. to Hams have characteristics as under—

Uniradio No. 5 (PT5M).—Impedance, 55 ohms; line velocity constant, 0.67; attenuation at 100 Mc., 4.5 db per 100 feet.

Uniradio No. 1 (PT29M).—Impedance, 75 ohms; line velocity constant, 0.67; attenuation at 100 Mc., 2 db per 100 feet.

In view of the above, to avoid too much loss in co-axial, keep it as short as possible between transmitter and radiator.

Having summarised the general formula relevant to the job in hand—formula which is generally sprinkled through handbooks—let us consider an example of feeding a vertical "J" type aerial construction using 55 ohm co-axial cable.

### Stubs Impedance

To end feed a half wave aerial with an end impedance of say 1,000 ohms (if you know the exact end impedance of your radiator use that) with 55 ohm co-axial cable, the following stub impedance would be required—

$$Z_0 = \sqrt{Z_1 Z_2}$$

$$Z_0 = \sqrt{55 \times 1000}$$

$$Z_0 = \sqrt{55000}$$

$$Z_0 = 234 \text{ ohms.}$$

Or for 75 ohm cable—

$$Z_0 = \sqrt{Z_1 Z_2}$$

$$Z_0 = \sqrt{75 \times 1000}$$

$$Z_0 = \sqrt{75000}$$

$$Z_0 = 274 \text{ ohms.}$$

### Stub Dimensions

Where the stub impedance and element dimensions are known, the spacing is found by transposing the formula—

$$Z_0 = 276 \log 10 \frac{D}{r}$$

$$\text{therefore } D = r \text{ antilog } \frac{Z_0}{276}$$

So assuming 1/4-inch diameter copper or other material for the elements and requiring the spacings of the elements, centre to centre in inches—

$$D = r \text{ antilog } \frac{Z_0}{276}$$

$$= 0.25 \text{ antilog } \frac{234}{276}$$

$$= 0.25 \times 7.04$$

$D = 1.76$ -inch spacing centre to centre of rods for 55 ohm co-axial cable.

Stub length—

$$L \text{ (inches)} = \frac{2952 \times V}{\text{Freq. Mc.}}$$

Radiator length—

$$L \text{ (inches)} = \frac{5540}{\text{Freq. Mc.}}$$

and there you have it.

(Continued on Page 6)

\*267 Jasper Rd., McKinnon, S.E.14.

# CLEARING THE ETHER. SERIES II

## PART IX

By G. GLOVER, VK3AG\*

### THE ANTENNA TUNER

In Part VII of this series the writer dealt with various types of output couplings from purely a theoretical angle. In this section the problem will be attacked from practical viewpoint.

The main points to be considered in the design of Antenna Tuner are:—

- (1) Location of Unit.
- (2) Scope of Unit.
- (3) Harmonic Rejection.
- (4) Band-Switching.

**Location of Unit (1).—**There are four locations suitable for the antenna tuner, namely:—

- (i) In the rack.
- (ii) On the wall (inside) at point of entry.
- (iii) On the wall (outside) at point of entry.
- (iv) In housing on post under antennas.

**Location (i)** This method of attack is best if space is limited, and the rig is set up in the living room of flat, or where direct coupling is employed.

**Location (ii)** In this case we must employ link coupling between R.F. stage and antenna tuner, as applied to unit described in Part VIII. The advantages of this location are:—

- (a) Open wire feeders (if employed) do not have to run around the shack.
- (b) All components may be mounted on wall panel to facilitate changes and inspection. Wall cupboard may be built over unit if desired.
- (c) Several sets of external feeders may be terminated behind panel and switching readily effected.

**Location (iii)** Unit used and conditions of use being the same as for (ii) with the additional advantage of being able to terminate feeders outside the shack. Where physical dimensions of shack are limited this also represents a worthwhile saving in space.

**Location (iv)** See remarks under (ii) and (iii) above. Additional advantage of using this system is that the feeders may be terminated at a point where least interference is caused to domestic operations. Naturally in order to effect quick changes of frequency with both systems (iii) and (iv) relays will be necessary.

\*Glorad Engineering Services.

**Scope.**—If all band operation is contemplated obviously due allowance must be made for the fact that input impedance will vary over wide limits. For instance if antenna employed is a doubler having two quarter wave sections at 7 Mc., then the impedance at point of attachment of feeders will be approximately 75 ohms; whereas same antenna at 14 Mc. and 28 Mc. will have centre impedance of approximately 1,200 ohms. The actual input impedance to line (at transmitter or antenna tuner) will vary according to  $Z_0$  (characteristic impedance) and length of line (if tuned). Without going too deeply into mathematics—

$$Z_{in} = \frac{Z_0^2}{Z_{out}}$$

Table 1 sets out impedance existing at feed point of two typical antennas. Table 2 sets out input and output impedances of three typical feeders under various conditions. Here we are concerned with range of input impedances encountered. Namely, 45 to 5,000 ohms (approx.). Thus we must design our antenna tuner to cope with this range.

**Harmonic Rejection.**—It is generally conceded that the easiest methods of improving harmonic rejection in antenna tuner is to:—

- (a) Employ Faraday shield between coupled coils, or alternatively to earth centre of antenna and link coils (hot end in case of link used with single ended amplifier) in order to reduce capacitive coupling effects.
- (b) Employ parallel tuned output circuit without tappings of any kind.

**Faraday Shield (a)** Unfortunately Faraday shields are cumbersome objects to contend with when plug in units are involved; hence recourse to earthing of link coils is usually necessary. Provided that direct radiation from transmitter is reduced to minimum by shielding, radiation due to capacity effects can be suppressed in antenna tuner.

**Parallel Tuned Circuit (b)** The employment of parallel tuned circuit for operation at H.F. where line input impedance is of the order of 5,000 ohms is impractical, because tuning capacity required would be reduced to an extremely low value. This value

being far less than the distributed capacity of circuit and internal capacity of inductor. Thus in order to employ parallel tuned circuit at H.F. we must reduce terminal impedance. At the other extreme (45 ohms) of course the value of capacity required becomes rather large at the L.F. end and conversely the value of inductance too low for effective operation. Obviously then we must select some intermediate value of impedance by—

- (i) Loading feeders with additional length of wire or cable.
- (ii) Adding inductance in series with each leg of feeder.
- (iii) Tapping feeders down coil in the case of low impedance line.

Tapping down coil tends to increase harmonics and extra lengths of feeders are difficult to accommodate; so, on the whole series inductors, in shielding boxes to prevent direct radiation, appear to be the answer.

Naturally we could dump parallel tuning and employ series tuning for low impedance input; however by so doing we lose harmonic rejection qualities.

**Practical Application.**—As experimenters we are just as much inter-

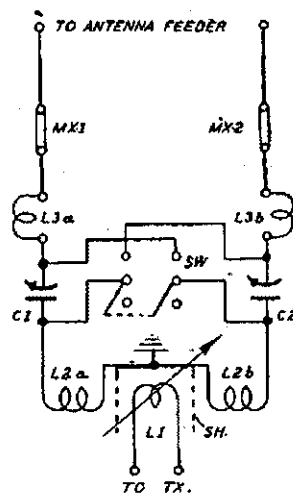

FIG. 14a

ested in finding out the whys and wherefores by empirical methods as by theoretical study. Figure 14a depicts circuit of wall mounting unit which will enable us to experiment to our hearts content with either series or parallel tuning.\* Figure 14b being plan of typical set-up.

As in most cases components for antenna tuner are taken from the junk box, information herein is

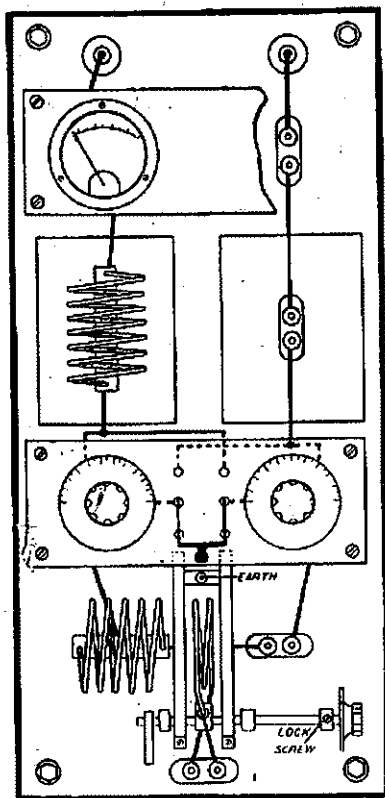

FIG. 14 b

mainly intended to serve as a guide to would be constructors.

L1, the input coil, is arranged on rotary mounting so that coupling to L2 may be varied. Counterweight to balance unit may be advantageously applied.

The Faraday Shield (see Figure 14c) is interposed between L1 and L2. In this case shield is a permanent installation and its construction is thereby simplified. Dimensions of shield should be at least twice the diameter of coils, and each section is constructed by threading two 3/16-in. brass rods at each end, screwing one end of each into brass base, and fitting nuts to support and lock top piece. Both brass base and bakelite top piece should be of 1/2-in. by 1/2-in. section, and holes to receive 20 S.W.G. tinned copper wire should be drilled every 1/4-inch in both members. In the case of bakelite top piece, holes should be enlarged at top to receive small eyelets. Having assembled main frame the tinned copper wire is threaded through holes in much the same way as a tennis racket is strung, care being exercised to keep wires taut. When in place

wire should be sweated to brass base and eyelets in top piece, after which interconnections are cut away so as to leave each wire entirely free from its neighbors, at top, forming a comb in effect.

L2 (a) (b) are constructed as separate coils for convenience and plug into standard pair of jacks.

C1 and C2 comprises two identical capacitors whose maximum capacity will depend upon the final conditions required of unit—see Table 3.

Sw. is d.p.d.t. knife switch for the purpose of changing from parallel to series tuning.

L3 (a) (b) are series loading coils which plug into jacks similar to L2. These units are enclosed in metal housings to prevent interaction and reduce harmonic radiation. When coils are not required dummy plugs are inserted in jacks.

Mx. 1 and Mx. 2 are pairs of jacks for insertion of R.F. Ammeters. In Figure 14b panel is shown in position on one side of unit with meter permanently mounted for the benefit of the rich and influential. For the poor cheaper means of current indication may be plugged into jacks. For example, the humble pea lamp with or without copper shunting loop. The pea lamp is quite a good indicator of resonance if shunted until only dim indication is available at resonance.

The Victorian Ham who is desirous of getting exact measurements of R.F. current is very fortunate, in that he or she may borrow suitable meter from W.I.A. Library. Dummy plugs are inserted in jacks in lieu of indicator. Where external antenna tuners are employed and external thermo-couples are available, the circuit of Figure 14d may be used to bring indication to operating position.

Band Switching.—The easiest way of attacking this problem is to em-

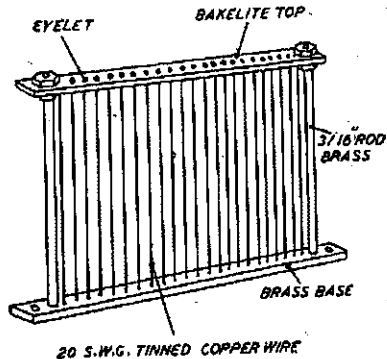
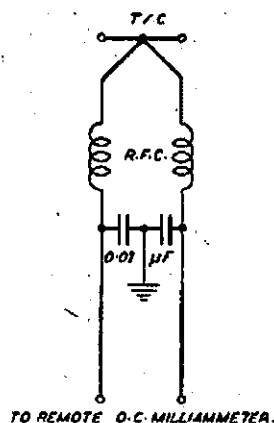

FIG. 14 c



TO REMOTE D.C. MILLIAMMETER.

FIG. 14 d

ploy separate tuning units for each band, employing minimum number of components in each case. Figure 14e shows the best method of switching from unit to unit by either switch or relay. Dead sections of line being cut off by back contact. Where individual antennas are used for each band the problem is still further simplified, because it is only necessary to switch output of units. Where common antenna is employed R.F. ammeters or thermo-couples should be installed in feeders after switching in order to eliminate duplication.

CONSTRUCTION HINTS

Input Coupling.—Spacing of shield should be reduced to minimum required to accommodate L1. L2a and L2b should be placed as near shield

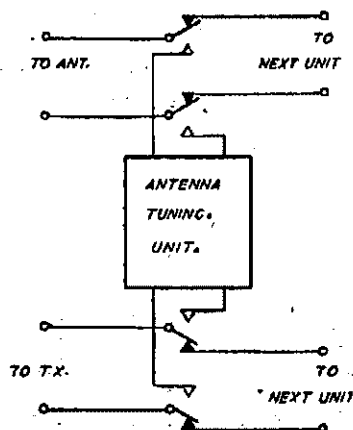

FIG. 14 e

as possible, otherwise coupling between two limbs will be too loose, and external fields will affect same too much.

Housings for L3a and L3b should be equipped with well fitting, and easily removable, covers.

Mounting.—Whole assembly may be mounted on either wooden base board or folded metal panel. Meter and capacitor mounting panels being of good quality insulating material. Individual meters, capacitors and switch can be mounted on ceramic insulators if desired.

Relays, if employed, should be equipped with H.F. insulation and contacts having large surface area.

Earths.—All components which have to be earthed should be connected by copper busbar of generous proportions, and "run" of busbar should be continuous from input to output.

TABLE 1

Antenna Description	3.5 Mc.	7 Mc.	14 Mc.	28 Mc.
Total Length	136 ft.	136 ft.	136 ft.	136 ft.
Wave Length End Fed	$\frac{1}{2}$ wave	1 wave	2 waves	4 waves
Impedance End Fed	1,200 ohms	1,200 ohms	1,200 ohms	1,200 ohms
Wave Length each side of centre	$\frac{1}{4}$ wave	$\frac{1}{2}$ wave	1 wave	2 waves
Impedance at centre	75 ohms	1,200 ohms	1,200 ohms	1,200 ohms
Total Length	67 ft.	67 ft.	67 ft.	67 ft.
Wave Length End Fed	$\frac{1}{4}$ wave	$\frac{1}{2}$ wave	1 wave	2 waves
Impedance at End	75 ohms	1,200 ohms	1,200 ohms	1,200 ohms
Wave Length each side of centre		$\frac{1}{4}$ wave	$\frac{1}{2}$ wave	1 wave
Impedance at Centre		75 ohms	1,200 ohms	1,200 ohms

TABLE 2

Zo of Line	Tuned	Wave Length	Z-in at Tx.	Z-out at Ant.	Remarks
75	No	Any	75	75	Both Z-in and Z-out must equal Zo for "flat" operation.
	Yes	$\frac{1}{4}$ wave	75	75	(i) Applies equally well to all odd multiples of $\frac{1}{4}$ wave.
	"	$\frac{1}{2}$ wave	45	1,200	
	"	$\frac{3}{4}$ wave	75	75	
	"	1 wave	1,200	1,200	
300	No	Any	300	300	NOT APPLICABLE TO ANT.
	Yes	$\frac{1}{4}$ wave	1,200	75	Refer to (i) above.
	"	$\frac{1}{2}$ wave	75	1,200	Refer to (i) above.
	"	$\frac{3}{4}$ wave	75	75	Refer to (ii) above.
	"	1 wave	1,200	1,200	Refer to (ii) above.
600	No	Any	600	600	NOT APPLICABLE TO ANT.
	Yes	$\frac{1}{4}$ wave	5,000	75	Refer to (i) above.
	"	$\frac{1}{2}$ wave	300	1,200	Refer to (i) above.
	"	$\frac{3}{4}$ wave	75	75	Refer to (ii) above.
	"	1 wave	1,200	1,200	Refer to (ii) above.

V.H.F. ANTENNA

A few practical notes may be more acceptable to a large number of the chaps who use V.H.F. channels, so the following table is included for 55 and 75 ohm co-axial cables, and other impedances can be worked out from the foregoing notes.

Co-axial Cable

Diameter of each Element	55 ohm	75 ohm
$\frac{1}{4}$ -inch	0.88-inch	1.225-inch
$\frac{1}{2}$ -inch	1.32-inch	1.873-inch
$\frac{3}{4}$ -inch	1.76-inch	2.45-inch
1-inch	2.20-inch	3.06-inch
1 $\frac{1}{4}$ -inch	2.64-inch	3.675-inch
1 $\frac{1}{2}$ -inch	3.08-inch	4.287-inch
1 $\frac{3}{4}$ -inch	3.52-inch	4.9-inch

This table gives a close approximation of the stub element spacings (centre to centre); an exact match can only be obtained by adjustment under operating conditions.

A suggestion to keep the rain and moisture out of co-axial cable and connections is to enclose the co-axial in an old cylindrical coil can after using a good "Poly" cement to seal the end of the cable. This can be connected to the outer braid via the connection and it will have little or no effect on the operation of the aerial.

TREATMENT OF STORED COMPONENTS BEFORE USE

Before replacing components, such as H.T. transformers, filter chokes or condensers, etc., back into service after a period on the shelf, thoroughly bake in oven in order to remove any moisture absorbed during period of idleness. The best method of proving insulation is to measure same with a "Megger" or "Megohmmeter," before and after baking. If oven is not available a few incandescent lamps in air tight box will do the trick.

TABLE 4

Coil	Diam.	Approx. Length	Wire Gauge	No. of Turns	Turns per in.	Mounting
A	3 inch	3 inch	16 S.W.G.	38	close	On Former
B	3 "	3 "	16 "	27	9	" "
C	3 "	2 $\frac{1}{2}$ "	14 "	20	8	" "
D	3 "	3 "	10 "	14	5	Self Supporting
E	2 "	3 "	10 "	14	5	" "
F	2 "	2 "	10 "	8	4	" "
G	1 $\frac{1}{2}$ "	1 $\frac{1}{2}$ "	10 "	6	4	" "
H	1 $\frac{1}{2}$ "	1 "	10 "	4	4	" "
J	1 "	1 "	10 "	4	4	" "
K	1 "	1 "	10 "	3	3	" "
L	1 "	1 "	10 "	2	2	" "
M	3 "	3 "	10 "	3	4	" "
N	2 "	2 "	10 "	2	4	" "

Deviation from the above figures will give satisfactory results; however figures given will prove useful in early stages of experiment.



# THE STORY OF THE DECIBEL

By D. A. GREENHAM, VK3CO\*

When you receive a report from a DX station of 10 db above R9 what does that really mean? It means firstly that you're putting in a very strong signal but how strong? The R9 report means on standard definition "very strong signal" which on the DX station's receiver may represent a power of 100 microwatts input from the antenna system.

When we have 10 db above R9, we mean that the signal you're putting in is 10 db above 100 microwatts or the "logarithm of the ratio of 100 microwatts to your signal multiplied by 10 is equal to 10 db."

To put this in formula we have:—

$$db = 10 \log \frac{P_1}{P_2}$$

where  $P_1$  = one power (larger)  
 $P_2$  = another power (smaller)

To arrive at the actual power arriving at the DX station's receiver we will substitute in the above formula thus:—

$$db = 10 \log \frac{P_1}{P_2}$$

i.e.  $db = 10 \log \frac{P_1}{100 \text{ microwatts}}$

Dividing both sides by 10 gives us:—

$$1 = \log \frac{P_1}{100}$$

Take antilog of both sides A.L. 1 equals 10:—

$$A.L. 1 = \frac{P_1}{100}$$

therefore  $10 = \frac{P_1}{100}$

therefore  $P_1 = 100 \times 10 = 1000 \text{ microwatts.}$

The actual power input to the receiver is now shown to be 1000 microwatts.

The db formula as shown previously is:—

$$db = 10 \log \frac{P_1}{P_2}$$

where  $P_1$  and  $P_2$  are the two powers involved.

In Ohm's Law we all know that power in watts can be found from the following formulae:—

$$W = EI \text{ or } W = IR \text{ or } W = \frac{E^2}{R}$$

where  $W$  = power in watts  
 $E$  = voltage across circuit  
 $I$  = current through circuit  
 $R$  = resistance or impedance of circuit.

Therefore substituting in the db formula we have the following:—

db = 10 log  $\frac{P_1}{P_2}$  ..... case i

or db = 10 log  $\frac{E_1 \times I_1}{E_2 \times I_2}$  ..... case ii

or db = 10 log  $\frac{E_1^2 \times R_1}{E_2^2 \times R_2}$  ..... case iii

or db = 10 log  $\frac{I_1^2 \times R_1}{I_2^2 \times R_2}$  ..... case iv

or db = 10 log  $\frac{E_1^2}{E_2^2}$  ..... case iv

If in cases iii and iv the resistance or impedance is the same in both powers then we can cancel these values. This then simplifies down to the following:—

$$db = 10 \log \frac{I_1^2}{I_2^2} \text{ or } 10 \log \frac{E_1^2}{E_2^2}$$

This resolves into:—

$$10 \log \left( \frac{I_1}{I_2} \right)^2 \text{ or } 10 \log \left( \frac{E_1}{E_2} \right)^2$$

To square a logarithm we just multiply by 2, so we can now resolve to the following final result:—

$$db = 20 \log \frac{I_1}{I_2} \text{ or } 20 \log \frac{E_1}{E_2}$$

To apply this in practice we may have a certain current flowing in a 70 ohm co-axial cable to the antenna. If we increase or decrease this current we can see what difference will be made to the distant receiver.

It has now been universally accepted that one S or R point is a change of 6 db in received signal. To apply this to a practical case we may have a current in the co-axial cable of, say, 0.5 amp. To raise the signal this current produces by 2 S points, i.e. from say S7 to S9, we need a 12 db increase in power. We will calculate what extra current is required in the co-axial cable.

$$db = 20 \log \frac{I_1}{I_2}$$

$$12 \text{ db} = 20 \log \frac{I_1}{0.5 \text{ amp.}}$$

Divide both sides by 20—

$$0.6 = \log \frac{I_1}{0.5}$$

Take antilog of both sides (A.L. 6 equals 3.981).

$$3.981 = \frac{I_1}{0.5}$$

therefore  $I_1 = 3.981 \times 0.5 = 1.9905 \text{ amps.}$

or approximately 2 amps.

Therefore to increase 2 S or R points would have to raise the antenna co-axial cable current from 0.5 amps. to 2 amps. or 4 times the current. (Incidentally, this method can be used to calibrate your S or R meter.)

It can be shown from calculation that a power increase or decrease of 2 is equal to a change of 3 db or  $\frac{1}{2}$  an S point. This means that if we increase the power of our transmitter from 50 watts to 100 watts the difference is  $\frac{1}{2}$  an S point.

From calculation it can be shown that the American limit of 1,000 watts compared to our 50 watts is not so great in actual S points or db relationship.

$$db = 10 \log \frac{P_1}{P_2}$$

$$db = 10 \log \frac{1000 \text{ watts}}{50 \text{ watts}}$$

$$= 10 \log 20 \quad \{\log 20 = 1.301\}$$

$$= 10 \log 1.301$$

$$= 13.01 \text{ db.}$$

Therefore the  $W_s$  are actually only 13 db. above us before they leave the shack. If we put in an antenna installation with directional properties we can quite easily make up that 13 db and more with quite a saving in the power bill!

We will now give a typical case, assuming the ether conditions are equal and stable both ways and equal impedances are used in the co-axial cables. Assuming we need 1.0 microwatt to produce an S9 signal in California and we are transmitting 10 watts from the antenna. If we receive an S9 report the loss in the transmission path will be:—

$$10 \log \frac{P_1}{P_2} = \frac{10,000,000 \text{ microwatts}}{1.0 \text{ microwatt}}$$

$$= 10,000,000$$

$$10 \log 10,000,000 = 10 \times 7 = 70 \text{ db.}$$

\*35 Bertram St., Gardenvale, S.4.

For the purposes of demonstration let us make 1 watt = 0 db, then the level transmitted from our dipole antenna is:—

$$\begin{aligned} \text{db} &= 10 \log \frac{10 \text{ watts}}{1 \text{ watt reference}} \\ &= 10 \log 10 \\ &= 10 \text{ db above 1 watt reference level.} \end{aligned}$$

By this we mean that the power transmitted from the antenna is 10 db above 1 watt or +10 db on 1 watt. This passes through the ether path of 70 db loss and arrives at California at -60 db below 1 watt; i.e. +10 -70 = -60 (algebraic sum).

Now taking the reverse case, i.e. W6 to VK, we have 100 watts in the antenna which is—

$$10 \log \frac{1000}{1} = +30 \text{ db.}$$

This signal leaves W6 land at +30 db, passes through the 70 db loss path and arrives here at—

$$+30 \text{ db} - 70 \text{ db} = -40 \text{ db below 1 watt.}$$

To improve our signal in W6 land we could either increase power to 1000 watts or utilise a more efficient antenna system. A three or four element close-spaced beam will give a forward gain of 20 db if designed

correctly. This will now give us a 20 db lift which brings the VK power into comparison with the American kilowatt.

It will be seen that by using 10 watts in VK land and 1000 watts in W6 we can exchange equal signal reports by using a directional antenna at VK transmitting end. This may sound fantastic to the old-timer but it is fact and can be very easily proved.

We can make a scale to show what power is required to increase and decrease S points assuming 10 watts is producing an R5 report.

Report	Power needed in Antenna
S1	0.039 w.
S2	0.156 "
S3	0.625 "
S4	2.50 "
Reference report S5	using 10 watts
S6	40 "
S7	160 "
S8	640 "
S9	2560 "

These figures may appear fantastic but it is fact and it shows that the man with 10 watts has as good a show of working DX as the next man even though he may be using 1 kw. or so. This will definitely substantiate the

old saying that "if you can work 'em with 100 watts you can work 'em with 50!"

**UNIRAD CO-AXIAL CABLE SPECIFICATIONS**

**Electrical**

No. 4: type, PT-5-M; impedance, 45 to 52 ohms; prop. factor, 0.85 to 0.68; loss per 100 feet, 0.5 d.b. at 5 Mc. and 4 d.b. at 200 Mc.; capacity per foot, 35 mmfd.

No. 5: type, RP 126/28; impedance, 41 to 52 ohms; prop. factor, 0.65 to 0.68; loss per 100 feet, 8.2 d.b. at 600 Mc.; capacity per foot, 37 mmfd.

No. 32: type, PT-1-M; impedance, 75 ohms; prop. factor, 0.65 to 0.88; loss per 100 feet, 8 d.b. at 200 Mc.; capacity per foot, 25 mmfd.

**Mechanical**

No. 4: inner conductor, 7/32-inch; inner diameter of outer conductor, 0.285-inch; overall diameter, 0.405-inch.

No. 5: inner conductor, 7/32-inch; inner diameter of outer conductor, 0.285-inch; overall diameter, 0.405-inch.

No. 32: inner conductor, 1/32-inch; inner diameter of outer conductor, 0.128-inch; overall diameter, 0.230-inch.

**A  
B  
A  
C**

**AUSTRALIA'S  
BEST  
AMPLIFIER  
COMPONENTS**

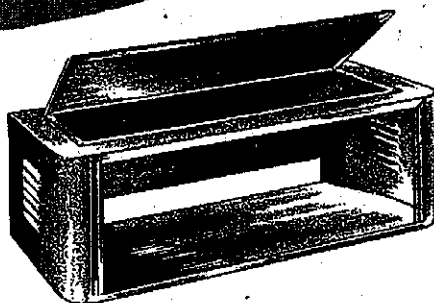

**ABAC  
Standard  
Receiver**

Or Instrument Case. Takes 19 x 8 1/2 inch panel with clear panel space 17 1/2 x 7 1/2. Depth of case 11 inches.

MANUFACTURED BY

**TRIMAX TRANSFORMERS**

29-35 FLEMINGTON ROAD  
NTH. MELBOURNE, VIC.  
(Division of Cliff & Bunting Pty. Ltd)

# THE BAROMETER OF W'BLD OPINION

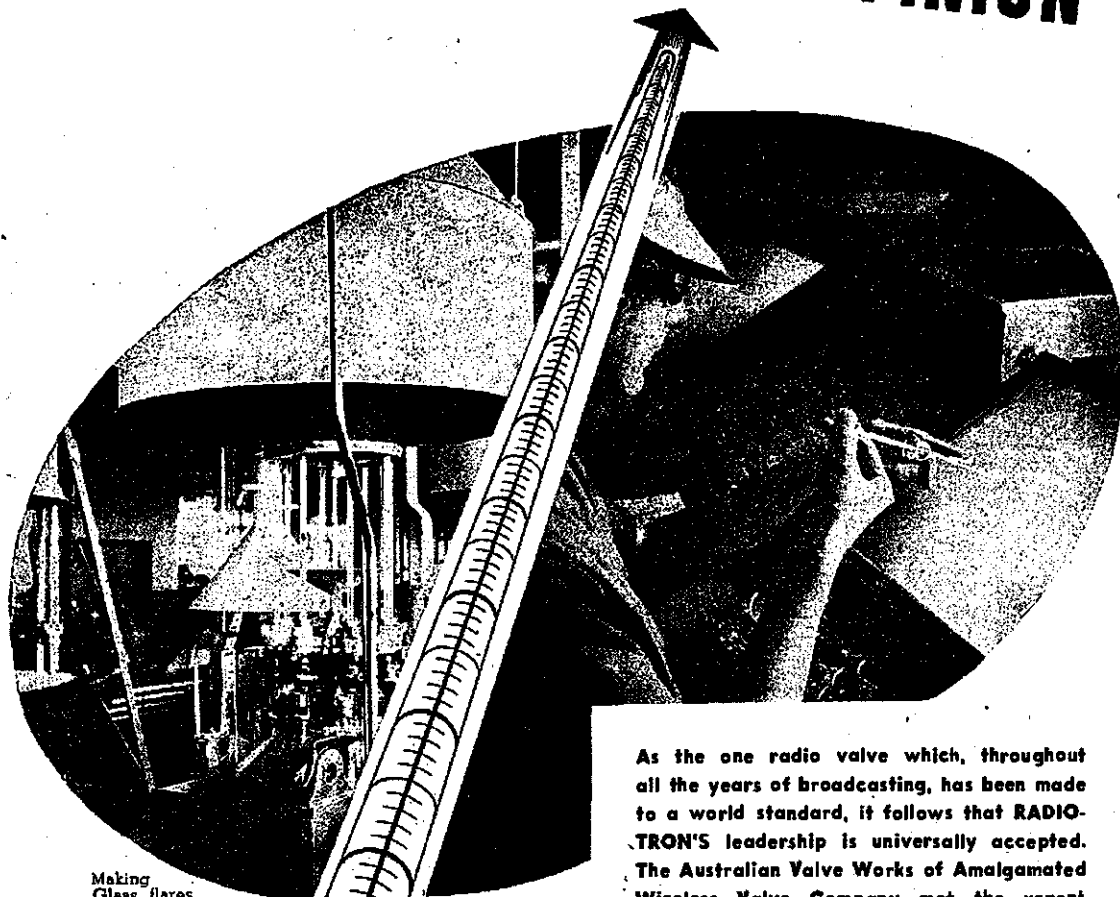

Making Glass flares for radio valves . . . . .

. . . . . Examining flares over an illuminated screen.

As the one radio valve which, throughout all the years of broadcasting, has been made to a world standard, it follows that **RADIO-TRON'S** leadership is universally accepted. The Australian Valve Works of Amalgamated Wireless Valve Company met the urgent needs and uncompromising standards of defence throughout the war — the same organisation, to-day, is increasingly competent to provide the growing needs of peace.

W&S

AMALGAMATED WIRELESS  
VALVE COMPANY PTY. LTD.

W&S



**Radiotron**  
VALVES  
MADE IN AUSTRALIA

Administration . . . . 47 York Street, Sydney, N.S.W.  
Manufacture . . . . . Parramatta Road, Ashfield, N.S.W.  
Distribution . . . . . Crown Street, Glebe, N.S.W.

V2



## SUCH NICE PEOPLE

BY "GREMLIN"

Greetings, Clients and others. An infant is born—a prodigy of "QRZ" of "Amateur Radio" fame in the '34s, 12 years BQRM to you.

Don't know if I'm in diapers or a dilemma. These fone boys have me really nicely confused with their reporting system. QSA5 R7 some say. I guess they mean readability 5 strength 7, but whatever happens, don't say so. Let's keep it all confused with no uniform system, I like it that way. Why not use an RST system, readability, strength and twaddle, the latter in units of kilowatt hours?

Dropped in at a VK3 meeting a few weeks ago. Nice gang down there. Nice YL's, air conditioned meeting room, padded chairs, and they agree on things. Some VK2s have the wrong idea.

Was told 3RX has the old glint in his eye and is dusting up the spark coils. Speaking of old times, 3WG has a brand new shack, got AC running in at the moment. Some blokes have it running out as well, ask 3RW how to mutilate the S.E.C. product.

Good fun keeping the chap the other end in suspense. 2CL thinks so too, 15 CQs and one signature. Don't think for one moment that's a record. I'm not going to tell you my best score to date, not until I'm a bit quicker on my coloured beads over thirty. 3VJ provides good counting practice.

Ever listen to 2AEZ? Don't, Ern is just one of the many nice ops, some blokes might get ideas and then where would I be?

2AFS makes a nice QSO, no need to get bored listening to him. If there

isn't a good hefty broadcast program coming over, other background noises make fine listening.

Heard 3XN asking if there was any hum on his carrier. You should spend more time on the Palmolive Show OM.

2CI believes his V aerial is responsible for getting out. Maybe your modulation helps.

2AHA thinks power is the secret to success. Reduced it to a bit over 50 watts, well under half normal power and found himself still R9. Where do you get this third class of licence OM?

Well blokes and pretties, must be off, trying to solve the problem of modulating an 813 final with PP 211s on a dinkum 50 watt basis!

I guess the wx up VK4 way isn't conducive to bad behaviour, in amateur radio at any rate. Maybe the long nights will tell, I'll be listening. Haven't heard 4JU for a long time.

5FL puts out some nice fone. Believes in a "readability, strength" system of reporting too.

Non-fraternisation isn't something which developed out of the recent world wide fun and games. VK6s always found it helped in not encouraging the newcomer to amateur radio—from a QRM point of view maybe they have something. After all you aren't born with a key in your hand although I wouldn't be sure of microphones. Every youngster we put on the right line today will be an asset to our cause in the future. On that score I noticed at the aforesaid VK3 meeting, a sprinkling of curly heads adorned by that peculiar form of headgear applicable to school

age in that State. I came away with a nice warm glow—like a few final stages I know!

Watch for me next month, you might be lucky.

We welcome the prodigy of the old "QRZ" who, in days gone by, did much to help the elimination of bad signals from the amateur bands. If "Gremlin" follows in the footsteps of his "Master" many bad signals, poor operating, etc., should quickly disappear.—Editor.

## FOR THOSE SPECIAL PARTS

Octal Ceramic Sockets 3/8 ea.

5-pin Ceramic Sockets 3/8 ea.

Acorn Ceramic Sockets 3/10 ea.

0-1 M/a English Uncalibrated  
4½" dia. Meters . . . 20/- ea.

0-500 Micro-amp. Meters, scale  
0-15; 0-600 v., to clear at  
18/6 ea.

Transmitting Condensers, single  
section, all brass construction,  
160 mmfd and 240mfd 25/-

English Electrolytic Condensers,  
semi-dry, in aluminium can,  
8 mfd 600 v. peak . . . 6/6

### BARGAINS TO CLEAR.

2½" Round Knobs . . . 4/- doz.

¾" GR Type Knobs . . . 5/- doz.

210 Tubes, Ceramic and Micanol  
bases . . . . . 12/6 ea.

SPOT Toggle Switches . . 2/- ea.  
All prices include sales tax.

## AUSTRYL

## Radio Supplies

T. D. HOGAN (VK3HX)

127 OAKLEIGH ROAD

CARNEGIE, S.E.9

Telephone: UM 1732

### A.O.C.P. CLASSES VICTORIAN DIVISION

Applications are invited from members of the Victorian Division for the position of:—

1. Class Manager
2. Theory Instructor
3. Morse Instructor

for the next series of A.O.C.P. Classes to be conducted by the Division.

Particulars regarding rates of remuneration, etc., may be had from the Secretary, Wireless Institute of Australia, Victorian Division, Box 2611W, G.P.O. Melbourne.

Applicants are requested to forward their applications immediately.

## FEDERAL QSL BUREAU

### RAY JONES, VK3RJ, MANAGER

State QSL Managers please note that cards for VS1QB will be accepted by VS1BX, PO's Mess, R.N.A.S., Sembawang, Singapore. Cards for VS1FB will be delivered by G6GL at his G address.

The par in February issue re non-QSLling to PK6HA has drawn blood in several places. I hope it is instrumental in removing Lt. Hagers' cause for complaint with regard to VK.

"Barney" (VK3VD) was temporarily located at the Lighthouse Cape Otway, Victoria, during March and April and misses his rig. Sorry "Barney" the efforts to obtain you the loan or hire of a suitable Xmitter was of no avail.

A letter has been received from Lloyd D. Colvin, Major, 71st Signal Service Battalion GHQ, U.S.A. Forces Pacific, dated 7th February. "With the approval of the A.R.R.L. my wife and myself (both licenced amateurs) are acting as QSL Bureau for Japan Amateur Stations. All correspondence should be addressed: Major Lloyd D. Colvin, J2AHI, 71 Sig. Ser. Bn., A.P.O. 500 c/o P.M. San Francisco U.S.A." As this Bureau has the backing of the A.R.R.L. it probably supplants that started by Major Drudge-Coates the QRA of which was advised in a past issue of "A.R."

A pleasant surprise during February was a note from VK3TL, of Kerang, stating he had resumed activities. Glad to hear of it Treb and guess many others will feel the same about your resumption.

VK3WL is temporarily located in Sydney. It is not known whether he has lifted out a VK2 call sign.

VK2ANE, Mobile Marine on S.S. Chertsey, writes from Fremantle to advise that at end of February he is leaving VK and returning to England with an interim stay in Italy. He bemoans the fact that his station will have to remain silent until he reaches G unless he can lift out a temporary call in Italy. Eric thanks all VKs for the co-operation and splendid hospitality he received and enjoyed wherever he went in VK and states that while in VK waters he worked 32 countries, 200 VKs and made WAC five times, all on 20 fone. He desires all outstanding wallpaper—and there is a lot—to be sent either to the VK2 Bureau or to his home QRA at 12 Downs Road, St. Helens, Lancs., England.

A Xmas Card has just arrived from the J.A.R.L. c/o. Tokio Institute of Technology Ookayama, Meguroku, Tokyo, signed by the President, Dr. Hidetsugu Yagi, and stating the officers to be J2GY, J2IS, J2JJ, J2KG, J2KJ, J2NF, J7CG. It is presumed these call signs are of the old vintage and maybe the officers

listed are the sole surviving members.

The following has also been received from Germany: "On 17th August, 1946, the W.B.R.C. was created in Stuttgart in order to represent the interests of the German shortwave amateurs. The forwarding of QSL cards has been allowed by the Military Government and thus we are able again to send receiving reports (the devil take em—VK3RJ). Incoming QSLs should be addressed to W.B.R.C. QSL Manager, Jorg Issler, Stuttgart-S, Christophstr 27, Germany, American Zone." A brochure sent with the letter sends greetings to all amateurs and the hopes that 1947 will see the restitution of amateur licences to the Ds and thus enable them to renew their efforts toward the amateur movement and contributing to the co-operation between countries with the ultimate aim of securing everlasting peace of the world.

PZIRM, of Surinam, enclosed the following request with a bunch of cards. "Would appreciate any old copies of the VK magazine so I can see what's going on down under. I have a sister in Brisbane." Would anyone replying to his QSL oblige with an old "Amateur Radio."

The official QSL Bureau for China is C1KC; QSL Bureau, C.A.R.L., P.O. Box 409, Shanghai, China.

A note from BERS 195, Eric Trebilcock still located at Box 12, Wynyard, Tasmania, shows Eric to be as active as conditions will permit. He states "Post-war I have heard 133 countries. I have made 71,876 log entries in 21 years and aiming at 100,000!" Quotes the following choice ones heard I6USA in Eritrea, CT2XA in Azores, LI2CL QTH unknown. All these on 14 Mc. Eric is busy erecting directional antenna for the listening section of the B.E.R.U. He is living 22 miles from his job but says the daily journey is worthwhile. Eric hopes to lift out his call sign again when situated where he could use it.

Writer got quite a negative thrill when he noticed on a card from G6YL, the following accusation, "Tks vy for QSO. Sri VK3RJ on fone was on my freq. and in the CW portion of the 28 Mc. band. Too bad." The card was to VK3NM and writer, with just resentment surging through his being, tackled Norm about it. However VK3NM was able to assuage the ruffled feelings by stating that he had told Barbara (G6YL) that VK3AJE was on her freq. on fone. So Barbara couldn't have been receiving too well on that day.

Received the following request this month which, when translated, read as under. "Am desirous of emigrating to VK, am 35 years old and by trade an engineer, etc., etc." Hans Schneeberg, Engineer for Fernmeldetechnik, Fallingbostal, Germany. Sorry Hans,

(Continued on Page 24)

## FEDERAL NOTES

### FEDERAL CONVENTION

By the time this issue of the Magazine reaches you the 17th Federal Convention of the W.I.A. will be in full swing, possibly will be over. This Convention will be one of the most important in the history of the Institute, as it is expected that the work done on the new Constitution during the past year by the Federal Executive will bear fruit in the adoption by the Federal Council of a Constitution based on the draft submitted to the Divisions some little time ago.

With its organisation and financial structure placed on a sound basis the Institute will be ready to go forward to full achievement of its aims. The Agenda for the Convention has been circulated to the Divisions, and no doubt has been carefully considered by them. While this year's Agenda is not the colossal paper that last year's was, there are nevertheless a number of very important items, and much of a constructive nature should come from the deliberations of the delegates assembled in Melbourne at Easter for this, the most important event of the year for the W.I.A.

### AUSTRALIAN DX CENTURY CLUB

We have previously mentioned in these notes the impending formation of the Australian DX Century Club. The proposed rules have been circulated to the Divisions, and constructive comments have been received from them. It now only remains for the rules to be rewritten in the light of these comments and the Club can get into action. The Convention being only a few weeks off, the Federal Executive has decided that the finalisation of the rules can best take place at the Convention. We hope that it will be possible to publish the rules in the form finally adopted in the next issue of "Amateur Radio" and if so, it may be possible to commence listing calls of members in the June issue.

### EXPEDITION TO USE HAM RADIO

An expedition of a most unusual kind, designated "Expedition Kontiki," led by Mr. Thor Heyerdahl, a Norwegian ethnologist, is about to leave Peru on a raft, to drift across the Pacific Ocean. The object of the expedition is to test theories of the westward migration of the Polynesian race, and Mr. Heyerdahl and his companions expect to be adrift for a period of about four months.

The raft, which measures only about 30 feet by 15 feet, will be equipped with radio gear, operating in the 14, 28 and 56 Mc. bands, the call-sign allotted being LI2B. As the

(Continued on Page 24)

# For the 'Short Wave' Amateur

## THESE 3 FAMOUS

# EDDYSTONE COMPONENTS

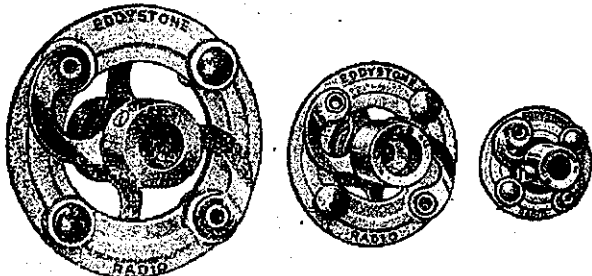

**FLEXIBLE COUPLERS**—Completely flexible yet free from backlash. Insulating material—white DL12, which possesses excellent electrical and mechanical properties. Spring metal arms are of phosphor bronze.

Cat. No. 50 Large Flexible Coupler for  $\frac{1}{4}$ " spindles . . . . . 4/11

Cat. No. 529 Medium Flexible Coupler for  $\frac{3}{8}$ " spindles . . . . . 4/5

Cat. No. 550 Small Flexible Coupler for  $\frac{5}{32}$ " spindles . . . . . 4/1

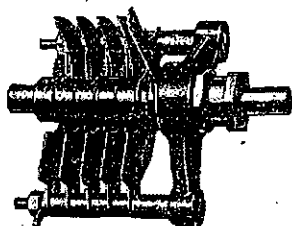

**LOW LOSS MICRODENSERS**—This popular Microdenser possesses many excellent features, including soldered and heavily silver plated brass vanes, substantial DL9 end plate, adequate bearing bush and extended spindle for ganging purposes.

Cat. No. 1094 20 pF Microdenser, double spacing . . . . . 11/5

Cat. No. 1129 40 pF Microdenser, double spacing . . . . . 12/6

Cat. No. 1093 60 pF Microdenser, single spacing . . . . . 13/5

Cat. No. 1130 100 pF Microdenser, single spacing . . . . . 15/-

Cat. No. 1131 160 pF Microdenser, single spacing . . . . . 15/7

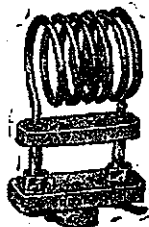

**V.H.F. INTERCHANGEABLE COILS**—These coils are wound with 14 gauge high conductivity electrolytic copper wire and are heavily silver plated. A 4-turn coil covers 4-6 metres combined with the 3-turn as aerial coupling. The 5 and 8 turn coils cover 6-8 and 8-10 metres combined with the 4-turn as coupling coil.

Cat. No. 601 3 turns Inductance 0.22  $\mu$ H . . . 3/9

Cat. No. 602 4 turns Inductance 0.32  $\mu$ H . . . 3/9

Cat. No. 603 5 turns Inductance 0.43  $\mu$ H . . . 3/10

Cat. No. 604 8 turns Inductance 0.74  $\mu$ H . . . 4/2

Cat. No. 605 10 turns Inductance 1.03  $\mu$ H . . . 4/5

Cat. No. 606 FREQUENTITE BASE for above . . . 2/11

NOW AVAILABLE  
FROM YOUR DISTRIBUTOR

- VICTORIA: J. H. MAGRATH & CO.  
208 Little Lonsdale Street, Melbourne.
- N.S.W.: JOHN MARTIN PTY. LTD.  
116-119 Clarence Street, Sydney.
- QUEENSLAND: CHANDLERS PTY. LTD.  
Cnr. Albert and Charlotte Sts., Brisbane.
- WEST. AUSTRALIA: CARLYLE & CO.  
Hay St., Perth & 397 Hannan St., Kalgoorlie
- STH. AUST.: GERARD & GOODMAN LTD.  
192-196 Rundle Street, Adelaide
- TASMANIA: W. & G. GENDERS PTY. LTD.  
53 Cameron Street, Launceston.

Australian Factory Representatives:

**KEITH HARRIS & CO. PTY. LTD.**  
51 William Street, Melbourne  
Telephone: M 1110

**AN APOLOGY**—in our March advertisement Cat. No. 581 (Condensers) was listed as 6/5. This price should have been 10/3. We regret this error and trust that it has not caused you any inconvenience.

## RAMBLINGS ON DX BANDS

### WESTERN AUSTRALIA

28 Mc. Fone.—Very spasmodic during this month when band has been wide open on three or four occasions.

Europe.—Many good signals heard but conditions have only favoured new contacts. Apart from a few Cs, LX1SI has been the only one from this continent during early evening.

Africa.—Toward end of month ZSs coming through very well. ZS1AX,

ZS5BS and ZS6JB among the best from Southern Africa in afternoons with OQ5BH, Belgian Congo, and SUIHF, Egypt, providing excellent QSOs.

Asia.—The regular VU, VS1, VS9, J, and C1 stations frequently heard almost any time of the day and night although CR9AG, in Macao, makes an fb contact in the mornings.

North America.—From 0700 to 1300 almost daily Ws pound through and contacts are too numerous to mention—the majority being W6s and 7s, but it is usually 1100 before VK6 has been able to make contact. Canadians from West Coast have also been prominent. VE7EL, VE7AJU, VE7UM and VE7AJN, British Columbia, and VE6GY from Alberta, being nice QSOs.

South America.—The week-end of February, 22-23, from 1300-1500 provided quite some excitement in VK6. PY2CK (Brazil), HK3DD (Columbia), OA4AX (Peru) being heard. Your attention is drawn to the personal pars for the VK6s who made contacts.

Oceania.—Few good signals apart from KA and PK coming through. KH6FC (Hawaii) being the furthest East worked, with a few ZLs and FK8NQ (New Caledonia) being surprises and turned out nice QSOs.

14 Mc. CW.—The last fortnight of February provided plenty of DX for the cw hound, although conditions earlier in the month were very unreliable. Europeans of a late evening were plentiful up to about the 18th. ON4UT, ON4ZQ (Belgium), UA3KAB (U.S.S.R.) and HB9CX (Switzerland) making good QSOs.

North Americans from 1600 thru the night to 0900 in droves—particularly Ws with few VEs. CM7AA, from Cuba, being interesting.

Asia, Africa and Oceania have also been plentiful but no contacts made during this month.

14 Mc. Fone.—Europe.—This continent falling off rapidly of late although earlier in the month a few excellent contacts made after 2300—G6XR, G2, UZ, ON4US, PA0UM being the pick.

Africa.—This continent also not as reliable as it was earlier, but nevertheless good QSOs have resulted after 2200. ZS5M, ZS6IW, ZS2CI and ZS6LF were the best of the South-erners with ZE2JD (Southern Rhodesia) and VQ8AD (Mauritius) being the pick.

Asia.—Plenty of VU, C1, VS, and J contacts made (all the usual stalwarts who keep Asia on the air). It's interesting to note that J4 prefix belongs to all VK and ZL Hams in B.C.O.F. Japan.

North America.—Conditions have changed in that Ws and VEs are now coming in via the Great Circle path from the North East and may be worked by the dozen almost nightly from 1700 to 2200 and sometimes later. KL7FY (Alaska) was a nice contact on the 9th at 1645.

Central America.—A few more of these rare birds coming through from 1600-2100, TI2OA (Costa Rica) being heard every week-end, but HR1MB (Honduras) and YN1LE (Nicaragua) being the only two contacted.

South America.—A surprise contact with YV5ADX (Venezuela) was made on the 21st at 1900. The unexplainable conditions prevailing probably from the recent sunspot activity resulted in him being worked with beam due East and his beam due North West. Work that out you Wave Propagation Bulletin readers!

Oceania.—A good variety of DX to pick from here—KH6IU (Hawaii) and VR2AL (Fiji Islands) being the pick.

We learn that VK3KX has now reached a total of 119 countries post-war. This is certainly a grand score. Wonder if any other VK Hams have a greater total? Write to Box 2611W, G.P.O. Melbourne, and let us know your total post-war countries and how you find the DX bands at your location.

## FIFTY AND UP

### VICTORIA

The U.H.F. group, which got under way three months ago and which meets on the Wednesday evening immediately following the general W.I.A. meeting each month, had a most successful meeting on Wednesday, 12th March. 23 members were present: VK3s: LS, AKI, ARN, AJH, YJ, KA, JU, TF, WW, DA, QO, YS, ABA, LR, MN, HK, BD, JO, RN and NW, and Messrs. Dow, Allen and Duncan. Owing to the retirement of Dave Medley (3MJ) from the position of chairman, 3NW was asked to carry on until such time as he leaves for the land of the Gs, and the meeting elected Fred (3YS) and his brother Jim (3ABA) as joint chairmen thereafter.

After a brief discussion of signals heard, etc., the meeting took the form of an inspection of portable 50 Mc. gear. Complete portable units of 3YS (2), 3HK, 3LR and 3NW were "on show" and those of HK, LR and NW were set in operation. A number of contacts was made from each of the rigs. Stations worked were 3GG, 3RZ, 3AHB and 3AFQ, using both a dipole in the W.I.A. rooms and another one on the roof. Some of the audience appeared quite startled on hearing the S9 reports that

## Bright Star Radio

K. G. ALLEN  
VK3UH, Late R.A.N.

Prompt deliveries to all  
States.

As Illustrated



40 or 80 metre  
AT or BT cut.  
Accuracy 0.2%  
of your speci-  
fied frequency,  
£2/12/6

Large unmounted 80 or 40  
metre, zero drift cut, £2;  
mounted 7/6 extra.

20 metre, zero drift mount-  
ed £5.

Crystals reground, £1 each  
Toyolr Transmitting Tubes  
in the following types  
available soon: T20, T21,  
T40, TZ20, TZ40, T55,  
TB35, 866 JR. Place  
your order now.

Data sheets on request.  
Filament, Power and Modu-  
lation Transformers made  
to order. Reasonable Prices  
Prompt Deliveries.

were obtained from this low power gear—none of the portables running more than 4 watts input!

It is intended to collect all the data concerning these portable outfits and write it up as a short article for this Magazine. Certainly the rigs were diverse enough in layout, circuit design and modulation systems, ranging from 6V6GT xtal osc. and quadrupler into an 807, single choke Heising modulated by D104 into 6C6 and 42; to 6V6 xtal osc.-dblr., 6L6 dbler. and 832 final, modulated by class A 45s and carbon mike. Receivers were equally interesting and diverse. At the next meeting a talk will be given by 3MJ on "Receivers for U.H.F. work" and it is hoped to have several there for demonstration.

No further DX has been worked from VK3 since the last notes appeared, but 3NW, sitting on Mt. Buninyong on Monday, 10th March, heard an unmistakably American voice discussing 50 Mc. activity and conditions. Signals peaked to S8 and appeared to come from the north east although, as only a dipole was in use and 3NW was too scared to try it "end on" for fear of losing the signal altogether, the direction could not be obtained very accurately. The signal was heard twice, for periods of 30 seconds or so, but faded each time before calls were given. 3GG reports hearing a similar signal on the 14th March.

We believe that 4HR has now had a two-way contact with a KH6 but confirmation of this is yet to come. However we do know that Tibby heard a KH6 and has had the report verified. The M.U.F. is still around 49 Mc. and some results should be obtained shortly.

3NW and 3MJ went to the Western Zone's Convention at Ararat on 9th and 10th March, plus the 50 Mc portable outfit and Dave's receiver. A pleasant time was had in company with the country boys, not to mention a splendid "dinner." On Sunday afternoon we sat in the sun on a hill overlooking Ararat and worked 3YS and 3ABA who were on Mt. Buninyong. Signals were very good over this 60 miles path. Also operating just out of the town was 3AMP and he was able to have a very good contact with 3YS and 3ABA. 3AMP is running 25-30 watts to an 807 in his portable rig; the oscillator being an e.c.o. 6V6 on 25 Mc. doubling in the output. The final is modulated by a 6N7. Other tests were carried out between Horsham and Ararat, and between Ararat and Melbourne but the results were nil.

3AMP has heard Melbourne stations in Colac, his home town, but signals are very weak and he has concluded that Colac is not a particularly good place for 50 Mc. work. From a hill just outside the town, however, he hears the city boys quite well and will go thither for field days.

Several new stations have appeared on the band during the month. 3RZ is putting out a good signal locally but lacks a beam at present. 3XA is back again, we hope for a longer stay this time. 3XJ has also appeared with a good signal, and last but not least (definitely not!) is 3IK, who must have become tired of ear-bashing the 7 Mc. fellows and is now going to give the higher frequency merchants a few doses.

3HZ, in Warrigul, now has a 3-element beam which has increased his signal about 6 db in Melbourne. The strange thing about Murray's signal is that we get it at surprisingly different strengths in different parts of the city. 3HK always receives him at a steady 6-8 db over S9. 3NW usually notices fading between S4 and S7. Others get him anywhere between S4 and S8 according, it seems, to their location. Differences in receivers, at least to this large degree, can be ruled out and it is an interesting problem why the signal behaves like this. Anyway Murray has now worked quite a number of the Melbourne boys including HK, YS, AHE, MJ, NW, etc.

166 Mc. Band

Activity on this band in Melbourne seems confined to the south east and southern suburbs at present. Stations are now on this band almost nightly and those definitely on and capable of two-way work are 3NB and 3ACM

## TECHNICAL BOOK & MAGAZINE CO.

297-299 SWANSTON STREET, MELBOURNE

(Opposite Old Melbourne Hospital)

Central 2041, Melbourne, C.I.

We can arrange subscriptions to any of the following magazines:

### AMERICAN.

RADIO: .....	25/- year	COMMUNICATIONS: .....	24/- year
Q.S.T.: .....	27/- "	RADIO NEWS: .....	32/- "
C.Q.: .....	25/- "	RADIO CRAFT: .....	22/- "
SERVICE: .....	24/- "	SCIENCE DIGEST: .....	23/6 "
F.M. & TELEVISION: .....	48/- "	PROCEEDINGS INST. OF RADIO	
ELECTRONICS: .....	97/6 "	ENGINEERS .....	88/- "
SPECIAL RATE FOR THREE YEARS: .....	195/-	POPULAR SCIENCE: .....	23/6 "
		POPULAR MECHANICS: .....	23/6 "

### ENGLISH AND AUSTRALIAN.

WIRELESS WORLD: .....	25/- year	WIRELESS ENGINEER: .....	42/- year
PRACTICAL WIRELESS: .....	13/6 "	ELECTRONIC ENGINEERING: .....	33/- "
AUST. RADIO WORLD: .....	10/6 "	RADIO AND HOBBIES: .....	6/6 "
AMATEUR RADIO: .....	6/- "	SHORTWAVE MAGAZINE (English): .....	25/6 "

FOREMOST IN AUSTRALIA FOR TECHNICAL BOOKS.

in Hartwell, 3UJ in Ashburton, 3OF and 3MB in Hampton, and 3TZ in Sandringham. Apparently 3NW can transmit but is unable to listen, while 3YS can listen but is unable to transmit.

Simple equipment is being used by these stations. In brief: 3NB is using push pull 2C22s with cathode and plate lines, a simple vertical dipole aerial and a three valve separately quenched superregen. 3ACM is using a transceiver with a single 2C22 and 6F5-6V6 modulator for I.C.W., a six element rotary beam 16 feet high is the aerial.

3UJ is using a 50T with 35 watts input, an eight element Yagi beam and a superregen. superheterodyne for receiver. 3OF and 3TZ are using transceivers with one 7193 in the R.F. part, and three element rotary beams. 3MB is using a 7193 in a linear oscillator and an acorn tube superregen. receiver. His aerial is a four element rotary, 15 feet high.

All aerials are vertical and power inputs range from 4 to 12 watts in most cases. Interesting results have been obtained, the longest two-way contact is at present 3ACM to 3MB, about 7½ miles with no intervening hills in the line of sight. 3ACM and 3NB have been heard by 3YS, with two ridges about 125 feet higher than either station breaking the line of sight.

3NB has been heard in the Dandenong Ranges and at several points on the road there and back. The signal was heard near Bayswater on a road about one half mile behind a rise forming the horizon. In this regard latest work from England suggests vertical aerials are better than horizontal ones for working to locations in the shadows of hills.

Average height of aerials at present being used is about 18 feet, but with a general increase in height, signals should be heard at reasonable distances. Nothing is known about activity, if any, in the northern suburbs, but with the present nightly activity, stations should find it worthwhile to give the 166-170 Mc. band a trial for interesting experimental work.

#### NEW SOUTH WALES

With the knowledge that the maximum usable frequency is in the region of 50 Mc. for the month of March, the activity on the 50 Mc. band in Sydney and the outer metropolitan areas, which for want of space we will include the Blue Mountaineers, is quite understandable, and any night of the week the following stations may be heard and contacted with a minimum of trouble. In the order of frequency starting from the low end of the band:—

VK2s: ZN, AGL, AHF, NO, JU, ABZ, EM, AC, AGO, YQ, MQ, LQ, LS, NP, AEX, LY, LZ, ABC, FO, AFE, AFO, WJ, DF.

Quite an imposing list to be sure, and one must conclude that as far as the city of Sydney and its outer suburbs, which as already intimated, includes the "three mountaineers"—2LY, 2LZ and 2AFO—is concerned, activity is most intense and if enthusiasm is any criterion then we will not have to wait long for some startling developments to occur in the DX line with overseas signals breaking through.

We have no news of the doings of the rest of the N.S.W. U.H.F. enthusiasts, but now that the W.I.A. has appointed an officer to handle any reports that they have to offer, and with the major thought of making these reports general knowledge to the rest of the world, so to speak, we know for sure that they will rally to the cause and forward any activities, however small, to the right quarter for publicity in "Amateur Radio" which is naturally the mouthpiece for members of the W.I.A.

We understand in the Newcastle area also that activity has reached a reasonably high level and only needs a breakthrough of Interstate signals to give the necessary encouragement to the persons concerned.

So summing up the situation one can safely say without fear of contradiction the N.S.W. gang who are actively engaged on the U.H.F.s. are at least doing their share towards justifying their existence on these frequencies.

The position is a little different on 166 Mc. and this band needs a lot of populating. VK2s: ABZ, AEE, WJ, LZ, AFO and LY are regulars and hold nightly contacts discussing this and that, and one is struck by the fact that very simple equipment is being used and results are remarkable considering the very low power that is being employed.

VK2KI has had astonishing results with mobile transceiver running from vibrator supply and holds the record along with VK2ABZ of contacting two-way telephony between Sydney and Bowral on the Southern Alps.

So the writer respectfully suggests that the persons who are really keen to get going on 166 Mc. contact any of the above mentioned who will gladly supply the necessary information as to what equipment they are using and will readily extend help to those who have difficulty in finding the band.

With the recent sale of A.S.V. and I.F.F. equipment in Sydney however, we can expect a few new stations on the air in the near, if not immediate, future.

Up to the time of compiling these notes, nothing is known to have been attempted, at starting operations on 1345 to 1425 Mc., but in Sydney VK2s NO, WJ, AEE, ABZ and NP have been heard discussing the various characteristics of the familiar, although

hard to obtain "Lighthouse" type of tube, so perhaps in the near future an effort may be made to get going on this band which has as yet to prove itself as being useful in the communication field.

As one idly turns the dial listening in on the various conversations on the U.H.F.s. one thought that seems to stick right out above any others is the absence of the familiar "rubber stamp" type of jargon that exists on the lower frequencies. Common phrases such as "OK on me being OK over there OM, that's OK" and such like with a few "Hi-His" and "handles" thrown in for good measure and with a couple of "very best 73" repeated here and there regularly, just to express good fellowship, seems to me to be rather superfluous, and quite unnecessary when contacting each other sometimes as much as three times per day and could very well be dispensed with, with no loss to prestige.

Operators who indulge in this practice could very well listen occasionally to the contacts on 50 Mc., which follow excellent procedure and with originality the foremost feature; and the general discussions on experiments previously carried out, gives the listener the impression that here, at least, are a band of enthusiasts who devote practically all their spare time to real experimentation on radio techniques in general which after all is the only reason for us being on the air, according to the wording of our licence.

We all agree that some over-the-back fence "chatting" is essential at times to enable us to carry out our experiments, but listening to some of the stuff that is turned out like gramophone recordings leaves one with a strong desire to turn to something of more technical interest.

However we are not here to criticise the doings of the low frequency gang but to try and stimulate interest on the U.H.F.s.

We know it's not going to be easy, but with a lot of co-operation on the part of the Interstate divisions of the W.I.A. in exchanging reports, etc., on all activity on the U.H.F. bands, plus plenty of observational work, we do believe that the time is not so very far off when we can expect some excellent work being carried out.

We hear on good authority that VK4HR has actually contacted a W7 portable in Honolulu which would seem to indicate that the real interesting period is about to commence.

We intend later as time and space permits to include a brief description of individual station equipment belonging to the N.S.W. amateurs with the idea of stimulating perhaps an added interest in our drive for recruits to the U.H.F.s.

(Continued on Page 24)

WHERE EXTREMELY HIGH ACCURACY IS DEMANDED

**DIVISIONAL NOTES  
NEW SOUTH WALES**

Secretary: Peter H. Adams, VK2JX  
Box 1734 G.P.O., Sydney.

Meeting Place: Science House, Gloucester and Essex Streets.

Meeting Night: Fourth Friday of each month.

A special meeting of the Division was held on 20th February to accept items to be placed on the agenda at the forthcoming Convention, but it was felt that many members missed an excellent opportunity to discuss important matters by their non-attendance.

The monthly meeting was held on 28th February and attracted the usual good roll-up for the lecture on "Batteries" given by the Secretary, Mr. Peter Adams (2JX). The lecturer was well versed in his subject, amply illustrated by slides, and held the attention of all. Prior to the lecture, the Morse recording made for the recent Field Day was played and members were invited to submit their interpretation of the Morse test contained therein. The winner will be announced at the next General Meeting. Thanks to Mr. Don Reed (2DR) for his efforts in providing the record and amplifier for the purpose.

During the month, the Technical Officer, Mr. John Moyle (2JU), who is one of the W.I.A. representatives on the Bushfires Committee, journeyed to Grenfell to assist in the demonstration there. Noel Arnold (2OJ) and Jim Taylor (2TC) were well to the fore, and the Shire officials were impressed with the efficiency of the radio communication and its overall effect on the efficiency of the organization.

A quantity of H.F. Xtals and 455 Kc. "gates" are now to hand and will be distributed soon at a nominal figure. A quantity have been allocated for country members. It will be necessary to ballot for the H.F. Xtals.

A recent appointment as V.H.F. Officer goes to Mr. Charlie Fryar (2NP) who now becomes an ex-officio member of the Council. Charlie's interest and good work on the ultra highs needs no elaboration. There is no doubt that V.H.F. is destined to play an increasingly important role in the years ahead, and adequate representation in this field is important to the Division.

An appeal has been made for technical articles for "Amateur Radio" and to stimulate interest, Council has decided to offer a prize of £1/1/- per month, for the best entry submitted. So go to it, chaps.

Membership is on the increase every month, and more members are

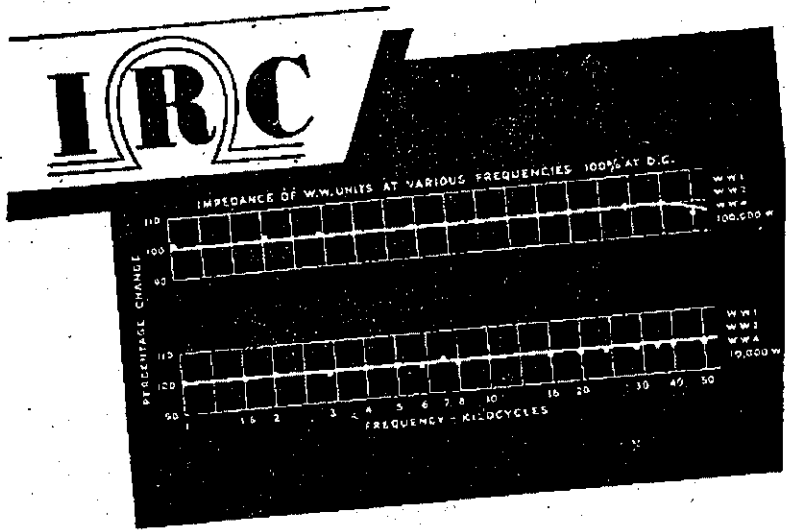

**PRECISION WIRE WOUND  
RESISTORS**

Available in all Resistance Values up to:

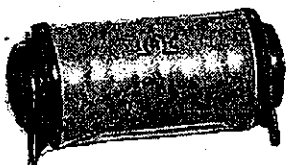

WW2 to 1.3 meg.



WW3 to 750,000 ohms.



WW4 to 350,000 ohms.



WW3 to 125,000 ohms.

They have been developed to meet the exacting demand called for in Talkie Equipment, Multipliers and Shunts for Meters, Attenuation Controls, and all applications where low temperature co-efficient, stability and a high degree of accuracy are essential.

Because of the special sectional construction and impregnation, which permit the winding of adjacent sections in opposite directions, a non-inductive winding of low distributed capacity is made possible. The impedance characteristics of these units are practically uniform and independent of frequency up to 50,000 cycles, as shown in graph above.

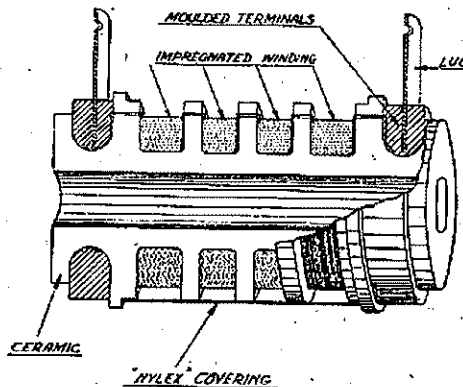

Sole Agents for Australia

**Wm. J. McLELLAN & CO.**

BRADBURY HOUSE, 55 YORK ST., SYDNEY • PHONE BX25D6

# A.G. HEALING

LIMITED

MANUFACTURERS AND  
DISTRIBUTORS FOR.....

Electrical and Testing Instruments for all purposes made to British Standard specifications. Each instrument is accurate, + or - 1 to 2 per cent., and parts are heavily plated to prevent corrosion even under tropical conditions. "Healing" Electrical Meters equal the best imported types and will give accurate service for long periods under the most exacting conditions.

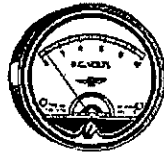

No. 10A round production mounting Black Bakelite Case.

Type No. 30A 4" square semi-flush Black Bakelite Case.

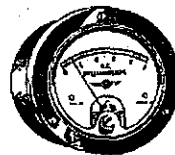
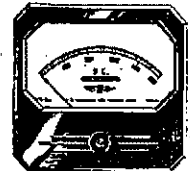

No. 20A 2½" round flush-mounting Black Bakelite Case.

These, and all other Healing Radio Electrical Testing Units, are manufactured in our own factories and available from A. G. Healing Ltd.

#### OTHER INSTRUMENTS INCLUDE:

Oscillators — Multi-Testers — Signal Tracers, etc.



ALSO MANUFACTURERS AND DISTRIBUTORS FOR

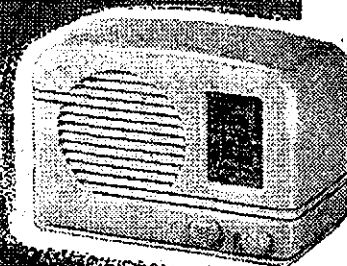

## Golden Voice RADIO

A. G. HEALING LTD., MELBOURNE, SYDNEY, ADELAIDE



coming forward to take an active interest in the affairs of the Division. It is your Division; constructive criticism and suggestions will be welcomed at all times. And if you need any help, do not hesitate to call on the Council for advice and assistance.

### COALFIELD ZONE

2KZ is still sticking to 28 Mc. and has been trying an 8JK. No success, going back to the old zepp which is much higher though. A three element rotary type going up soon. — 2YO, George, not heard for months. 14 and 7 Mc. are his bands. — 2TY heard on 7 Mc. but nil heard on 28 Mc. from Bob. How about some news of your doings? — 2DG who is 2TY's workmate at B.C. station 2HR is to be congratulated on taking out the 14 Mc. section of the DX Contest. Hopes to go into a new house in the Maitland area soon. — 2MK, Lance, spends most of his time on 7 Mc. these days and a 109 set works on 3.5 Mc. — 2PZ is mostly on 7 Mc. fone, a 109 set revamped does the job. Has lots of other gear under construction but servicing takes up a lot of his time. — 2ADT, Jack, won the 28 Mc. Section of the DX Contest and put up a fine score for an 807 and 30 watts. Has 83 countries up now and finds confirmation cards as hard to get as new countries. 208 W-VE contacts on the first week-end on 27 Mc. band and looking out for more. — 2YL raised 195 Ws on CW for the Sunday in the contest. DX now 104 countries and new ones scarce. Also on 27 Mc. Two new half waves in phase on 14 Mc. doing good work.

### SOUTHERN ZONE NOTES

Jim, 2ANQ, is brushing the cobwebs from his gear and with cooler weather says it won't be long now. — Dick, 2APW, has his receiver working nicely and finds plenty of gain with 1900 Kc. I.F.s. Is working cw on 7 Mc. using 6L6 tritet and 807. — Hughie who was pre-war VK2VK, has returned after five years in the U.K. and U.S.A. with the Merchant Navy. Hugh intends applying for his ticket again and will be on the air soon. — Hilton, 2QD, has rejoined the R.A.A.F.

Visiting Hams to 2OJ recently were VKs 2TA, 2TC, 2AEY and 3TA who came a long distance to attend the Disposals Sale. How do those class C wavemeters behave chaps? — 2EU and 2OJ visited Howard, 3YV, recently and spent a very enjoyable afternoon. — We would like to hear from other Southern Zone Hams. What is doing at Wagga, Corowa, etc. Send your notes to Box 54, Albury, by the 9th of each month chaps.

## VICTORIA

Secretary: A. B. D. Evans, VK3VQ.  
Box 2611 W.G.P.O., Melbourne.

Meeting Night: First Wednesday of each month.

Meeting Place: Radio School, Melbourne Technical College.

### THIRD WESTERN ZONE CONVENTION

The third post-war convention of the Western Zone was held at Ararat over the holiday week-end of 9th and 10th, and was very well attended by Hams from as far afield as Sea Lake, Melbourne, Colac, Warrnambool and Coleraine. A general field day was held on the Sunday afternoon, 50 Mc. gear being brought along by 3AMP, 3NW and 3MJ. The bush fire emergency was also given a try out by some of the boys who had brought along their FS6 and 108 transceivers. The 50 Mc. stations, working portable from the tops of convenient hills around the town were successful in working into Mt. Buninyong, near Ballarat, a distance of approximately sixty miles.

At 6.30 p.m. Hams, SWLs, Second Ops, and several guest visitors from the Country Fire Authority sat down to dinner, and at the end of this, a general meeting of the Zone was held. Matters of Zone interest were thrashed out, the main items being the Fire Emergency Network and the proposed new formation of zones in the State.

A further field day, together with visits to the local shack of VK3GN and points of interest filled in the Monday. George (3GN) is to be congratulated on his fine organising of all details of the Convention, which was an outstanding success.

### WESTERN ZONE NOTES

3NK reports from Camperdown that using only 15 watts to an 807 and an 8JK, he has worked lots of DX on 14 Mc. He worked the Byrd Expedition near South Pole. — 3SC is almost ready to get on the air. — 3AMP has super regen. receiver on 50 Mc. and has heard the Melbourne boys. — 3JA has new rotary converter which runs very silently. — 3TA works W on 7 Mc. phone. — 3YW still has not got the new pole up. — 3HL thinking in terms of rotary beams, but was talked into Vs and rhombics at the recent Convention. — 3MC getting lots of DX with the aid of a very good V.F.O., and is nearing the century. — 3HG in new shack and working plenty of DX but no new ones. Was active in the W contest. — 3NC still getting nice DX using stacked rhombic and flea power.

# Low Drift Crystals

FOR

## AMATEUR BANDS

ACCURACY 0.02% of  
STATED FREQUENCY

3.5 M/C and 7 M/C

Unmounted . . . £2 0 0

Mounted . . . £2 10 0

12.5 and 14 M/C Fundamental Crystals, "Low Drift" Mounted only £5.

Spot Frequency Crystals  
Prices on Application

Regrinds . . . £1 0 0

THESE PRICES DO NOT  
INCLUDE SALES TAX.

## Maxwell Howden

VK3BQ

15 CLAREMONT CRES.,  
CANTERBURY, E.7.

## QUEENSLAND

Secretary (acting): F. Nolan, VK4JU, Box 638 J, G.P.O., Brisbane.  
Meeting Place: State Service Building, Elizabeth Street, City.  
Meeting Night: Last Friday in each month.

This month our Publicity Officer (VK4ZU), who usually writes these notes, is unable to get notes together

and has asked VK4SN to help out this month. Howard is very QRL with Light Houses up the Queensland coast.

The February meeting of the Queensland Division was held on the last Friday of the month. Considering the very wet weather, the attendance was good. All present were of the opinion that an official W.I.A. Station was a must for VK4, and the powers that be are being approached with the hope that VK4WI will be operating in the near future. Frank, of VK4FN, was appointed Station Manager. In the meantime VK4HA will act as unofficial station for the dissemination of W.I.A. news, each Sunday morning at 1000 hours on 7100 Kc.

Nominations were received for office-bearers for 1947-48 year. Voting will take place at the March meeting. For the first time in the history of W.I.A. (Queensland Division), Country Members will receive Ballot Papers. The result of the election will be given in the next monthly notes.

4HZ of Gympie has AC laid on at last and Jim is now going QRO. ——— 4UX, Claude, has fb job for multiband operation. Good to hear you again OM. ——— 4OK, Jack and George, back on 7 Mc. again after 14 Mc. activity. ——— 4CU, Charlie, puts out nice fone on 7 Mc. Has new receiver now but QRL with local shows. ——— 4CZ, Sam, has ironed out bugs in his fone and is now putting out fine signal. ——— 4FN, Frank, has fb layout and after a visit to his shack the other day we are satisfied W.I.A. has appointed the right man as Station Manager. ——— 4ZU using portable rig with 5 watts fone. Howard takes portable on his round of Lighthouses. ——— 4EN, Eric, doing elephant sized job with QSL service. The consensus of opinion among VK4s is that Eric is the best QSL officer VK4 has had. Fb work Eric! ——— 4ES, Herb, will be holding the fort for Queensland at the Conference in Melbourne this year. ——— 4SN our Country Representative, would like to hear more from our Country Members. If the Country Hams don't let us know what they are doing in the radio field, little can be done by W.I.A. to assist them to a better enjoyment of their hobby.

Don't forget monthly meetings are held on the last Friday of each month.

## SOUTH AUSTRALIA

Secretary: E. A. Barbier, VK5MD,

Box 1234 K. G.P.O., Adelaide.

Meeting Place: 17 Waymouth Street, Adelaide.

Meeting Night: Second Tuesday of each month.

Once again we report a record attendance of over 140 members at

the monthly general meeting of the W.I.A. on Tuesday, 11th March. Thirty members of the Illuminating Engineers Society of Australia (S.A. Division) were present as guests of the W.I.A., and all appeared very interested in the lecture on "Recording on Disc" given by Pete Bowman (VK5FM), assisted by Allan Mathews. Pete treated his subject from the angle of amateur recording as distinct from the professional viewpoint, as he said that it was remarkable the number of "hams" who had approached him at various times for advice and helpful hints.

Commencing with a description of the construction and materials of the uncut disc, he went on to describe the requirements of a good recording set up, paying quite a lot of attention to the effects of turntable rumble and groove echo, etc. He described a simple, but effective, method of checking for vibration of the recording table by placing an ordinary drinking tumbler full of water to the brim on the said table and if any vibration is present the water in the tumbler will be disturbed, thus disclosing the extent of rumble.

Pete spent quite a lot of time, both orally and practically, demonstrating the effects of equalising (or attenuation of unwanted frequencies) as needed in the effective recording set up. He explained that as the normal movement laterally of the cutting head on the inside of the disc is much less than on the outside, some attenuation of the frequencies which cause this extreme movement of the cutting head is desirable. This attenuation is achieved in various ways and one of the simplest is to vary the size of the coupling condenser in the recording amplifier. A series of condensers may be mounted on a rotating switch and could be cut in and out according to the requirements of the recording being attempted.

Mr. Allan Mathews demonstrated by means of a portable turntable, etc., the various angles on equalising and recording technique as explained by Pete.

Question time followed and judging by the number and intelligent questions submitted, it was apparent that the lecture had been a success. The most interesting question from our point of view was "has the cut disc any further use or is it thrown away." The answer "old discs make good radio chassis" was greeted with a howl of delight from the assembled Hams. A vote of thanks, proposed by "Dougall" Whitburn, was acknowledged in the usual manner.

South Australia was honored by a Commonwealth Disposal Commission auction sale of radio receivers, transmitters, and various bits and pieces of radio gear last month. When the news broke there was a frenzied dash around to inspect the "bargains" and Hams came from all directions. The

auctioneers roped off the various tables apparently with the idea of keeping the boys back from the goods. Personally I think they were wise in roping off the tables because if they had not done so the enraged Hams would have been able to get at the auctioneers and tear them limb from limb. A bigger collection of junk was never exhibited. It was an insult to anybody's intelligence and to make it all the more exciting the receivers, etc., were split up and sold in sections, coils in one lot, valves in an-

### VK3NU

## Major Radio & Electrical Co.

189 GLENFERRIE ROAD,  
MALVERN

WM 1814 U 9354

**SPECIAL ! !**

**METER SCALES**— Suitable for "Disposal" Pullin meters. Two types, Volt-M.A.-Ohm and Valve and condenser tester.  
2/- each, Post Free.

### CHASSIS, RACKS, PANELS

We specialise in chassis and panels to your specifications. Write, enclosing full particulars, for a quotation.

### TRANSFORMERS.

**Multi Match Modulation Transformers.** 75 watt, mounted in die-cast metal clamps. Write for full specifications, £4/19/6. Prompt delivery.

### Power Transformers —

Wound on extra large core of highest grade stalloy. Any voltage or wattage. Reasonably priced with short delivery period.

other, receivers minus valves or coils and once or twice minus cabinet. The odd transmitter which by mistake came up for auction was a mate to the one that Noah carried in the Ark, and had apparently been on top of Mount Ararat exposed to the elements until the C.D.C. found it.

Chatting to a VK5 Ham who was in charge of the auction, he told me that the whole thing was organised without consulting him, so don't expect we could hope for anything better. Anyway if Ned Kelly did not turn over in his grave, I am a bad judge of prices for junk radio.

Understand from a VK5 Ham who is having B.C.L. trouble, that the P.M.G.'s. Department informed him that there is no such thing as exemption from obligation to avoid B.C.L. interference even if the set is a crystal set. If this is so it is necessary that the matter of B.C.L. trouble is aired at the coming Conference, as quite a number of Hams are under the impression that only "modern receivers" are meant in the regulations. This may be American practice, but won't hold water in VK. Anyway the Ham fixed the trouble OK if somewhat unethically. He accidentally burnt out the 24A in the set whilst checking up. Needless to say his stocks have slumped with the listener. COTTON on!

The recently appointed U.H.F. correspondents for this magazine have been conspicuous by their absence and this will account for the lack of information regarding the ultra highs. Anyway these frequencies have unwittingly become the "holy of holies" with an odd one or two these days, and a glance at the amateurs' code on the front page of the A.R.R.L. Handbook would not come amiss. Although when it was first printed, U.H.F. was undreamed of, the underlying principles of the code remain unaltered.

By the time you read this the W.I.A. display at the Royal Adelaide Exhibition will be on view for both praise and criticism. With respect to the praise, whilst acceptable, we were only too pleased to put a little time into giving amateur radio a boost and Jack Lester (VK5LR) is deserving of all credit. "Doc" Barbier and yours truly assisted where possible but "Johnny Lester" did most of the work, and will receive the putty medal. With respect to any criticism may I point out that nobody came forward when volunteers were called for, and therefore criticism would be out of order.

The last general meeting was probably the most outstanding that has been held for all time. The lecture was excellent, the crowd a record, never before have so many members been on their feet asking questions and sticking their necks out, and never before has a meeting finished

so late. All of this adds up to one thing, enthusiasm, and while we have that we can't go under. By the way fellows, don't hesitate to have a shot at me, I love it! I am the original "Aunt Sally."

It is pleasing to note that arising out of the incidents related to us, at the last general meeting held in January, by Mr. J. E. Cawthron (5JE), we read that he was mentioned in despatches, particulars of which were released last week. Good work Ted and another boost for amateur radio.

The field day has been revived under the disguise of a picnic and with a numerically strengthened committee it looks like results will at last be achieved. The newly formed committee has taken charge of the trophies and the fear hanging over my head that I might have to put in every night listening to "Doc's" receiver for three months has now gone. Anyway bread and water would have played havoc with my figure.

VK5RR has shifted to 7195 Kc. for W.I.A. broadcasts on Sunday mornings at 10 a.m.

Enrolments for the new A.O.C.P. are filling rapidly and intending students should see the Secretary immediately to avoid disappointment.

Heard two Hams discussing DX and gathered that they thought that 14 Mc. DX was the be all and end all of amateur radio. Suggest that they check up on the good work the U.H.F. gang are doing and also remember that DX has been available for many years now and will be available for many years to come. With the power available these days and the efficiency of apparatus, DX is not so remarkable as it was ten years ago when Nobby Prince (5WK) went W.A.C. on LOOP phone. I repeat, LOOP phone.

## WESTERN AUSTRALIA

Hon. Secretary: W. E. Coxon,  
VK6AG, Howard St., Perth, W.A.  
Meeting Place: Builders Exchange,  
St. George's Terrace, Perth.  
Meeting Night: Third Monday in  
each month.

The February meeting was held on the 15th of the month. No lecture was given as a large amount of business had to be conducted.

The President (6GM) reported on his visit to the Eastern States and particularly remarked on the favourable way in which suggestions had been received from VK6 by the other States. Since notes have appeared in "A.R." a new Council has been elected and stands as follows:—

President: G. A. Moss (6GM).  
Vice-President: W. Schofield (6WS).  
Secretary: W. E. Coxon (6AG).  
Treasurer: F. C. Lambert (6FL).

Federal Councillor:  
G. A. Moss (6GM).  
Traffic Manager:  
S. C. Austin (6SA).  
Country Liaison:  
E. A. Doddy (6WH).  
"A.R." Publicity:  
R. W. S. Hugo (6KW).  
Surplus Gear Exchange Officer:  
J. J. Mount (6EV).  
Activities and Lecture Committee:  
R. W. S. Hugo (6KW), H. G. Lang  
(6HL), W. M. Peterson (6LW), F. C.  
Lambert (6FL), E. A. Doddy (6WH).

## Australia's Largest Stock of All Radio Components

Chokes  
Coils  
Condensers  
Dials  
Intermediate Transformers  
Mose Equipment  
Potentiometers  
etc., etc.  
Resistors  
Soldering Irons  
Speakers  
Test Equipment  
Valves  
Pick-Ups  
Power Transformers  
etc., etc.

Obtainable from

## Bloch & Gerber Ltd.

with which is associated  
the

### WELDON ELECTRIC SUPPLY CO.

46-48 YORK STREET,  
SYDNEY

G.P.O. Box 2282 M

Phones: MA 6291 (10 lines)

At the Annual General Meeting the retiring Council were thanked for their efforts over the past difficult 12 months and the Treasurer and Secretary were handed a small donation for their untiring work.

Both these gentlemen, 6FL and 6HL suitably responded and announced that they were donating £5/5/- for a trophy; the type of competition being left to the Council to decide. The President received the offer with thanks.

### SURPLUS GEAR

#### A Service to All VK6 Members

As you have undoubtedly noticed, there has been a "Surplus Gear and Exchange Officer" appointed, 6EV being the chosen one.

It was felt that there must be quite a considerable amount of surplus gear held by all Hams that would be of assistance to others.

Under the new scheme, anyone wishing to dispose of or purchase gear should write to 6EV, c/o. P.O. Box N1002, G.P.O. Perth, stating what you have or want and approximate value. A small amount of 6d. up to 10/-, 1/- up to £1, and 5% over will be charged to the Purchaser to cover costs involved, such as postage, phone calls, etc. Any surplus cash goes to W.I.A. funds. Nominally there will be no charge of freight, etc., to country members except when goods are extra heavy.

### PERSONALITIES

Congratulations Frank (6FL) on making W.A.C. on fone at last. Yes, Frank made contact with HK3DD in Bogota, Columbian Republic, on Sun-

day, 23rd February. Frank is the fourth VK6 to W.A.C. on fone post-war. ——— 6DD is another lucky VK6. John worked HK3DD on 22nd February, and this makes him W.A.C. fone on both 28 and 14 Mc., being the third VK6 to make this feat. ——— 6RU worked YV5ADX in Caracas, Venezuela on 21st February on 14 Mc., so Jim is the second VK6 to make W.A.C. fone on both 28 and 14 Mc. ——— 6KW followed up his previous 28 and 14 Mc. South Americans by working OAIAX in Lima, Peru, on 23rd February, giving him W.A.C. on both bands in 1947 as well as 1946.

6DJ is regularly on cw. Made a surprising contact on short skip with 6MO at Watheroo on the 11th January. ——— 6DF is regularly on 28 Mc. We believe he has his new 18 tube super working now and will be back on air again soon. ——— 6KE is getting ready for phone. Was seen purchasing large quantities of modulation equipment the other day. ——— 6XI heard regularly on 28 Mc. but not by Perthites. Finds W contacts very easy up in Northam. ——— 6EL doing well with low power up in Geraldton. Quite a few DX stations were heard calling him lately.

6HL a tiger for 14 Mc. antenna construction. Reckons he will soon be heard outside Perth if he perseveres long enough. ——— 6EV is another aspirant to phone. Heard testing on 28 Mc. recently. ——— 6BC enjoying a well earned holiday at Rockingham fishing for "Fish" instead of bits and pieces for the new Xmitter. Bert is threatening to bash

the heaviside layer with QRM any day now. ——— 6NL heard mightily with quite a nice signal. Val has had receiver trouble; the type we all have had sometime in the shape of that old bugbear "image interference."

6WH has been busy building a new modulator and is now back with the usual 6WH style working on 14 Mc. ——— 6MU has been down in Perth for a few weeks' vacation. Mal says he had to give the Merredin air a rest for a while. ——— 6AH, Stan is keeping Wiluna on the map by making a regular hole in the ether these days. ——— 6RO still a busy man making his new ham receiver. Bert just revels in winding coils and building coil units and then finding them "punk." Then he starts all over again. Bert's theme song is "Why can't we do this more often." ——— 6JS has just been over among the wise men of the East. Heard over 3KU whilst in Melbourne.

## TASMANIA

Secretary: J. Brown, VK7BJ  
12 Thirza Street, New Town.  
Phone W 1328.

Meeting: Place: Photographic Society's Rooms, 163 Liverpool Street, Hobart.

Meeting Night: First Wednesday of each month.

The Council met at residence of R. F. Gee, corner of Montagu Street and Doyle Ave., New Town, on Friday, 28/2/47, at 8 p.m. and later. There will have to be a fine for late arrivals! Present were 7LJ in chair, 7BJ, 7CW, 7RF, 7PA and 7CT. Apology from 7CJ, who at this stage was still in the North.

Correspondence inward and outward to and from F.H.Q. and communications via official Traffic Net were read and received, some discussion ensued on a number of these items.

A discussion on Traffic Network and frequency resulted in a resolution, moved by 7CT and seconded by 7CW, that an official Xtal be purchased as suggested, being carried.

New Members.—Three applications were received and passed on for confirmation at the next General Meeting.

Accounts.—Petty Cash and general expenses accounts were passed, one being the necessary in conjunction with our delegates' trip to Conference.

7LJ gave an outline of the trip to Launceston and spoke with eloquence on the pleasant week-end spent with our Northern Members. It seems a lot of ifs and buts were ironed out and much good done for the W.I.A. here, this trip will be fully reported under separate heading.

One important decision was that an intra-State ragchew be held on 2nd and 4th Fridays each month on 3.5 and 7 Mc. as conditions warrant.

## IMPORTANT ANNOUNCEMENT BY

# GLO-RAD

CLIENTS ARE ASKED TO NOTE OUR NEW ADDRESS—

**GLORAD ENGINEERING SERVICES**

**186A RIVERSDALE RD. (Cr. Robinson Rd.)**

**HAWTHORN . . . VICTORIA**

**PHONES: DAY: WA 3819 NIGHT: WX 3440**

zero hour 8 p.m. A phone broadcast of the Division's general activities to be part of each evening's programme—7CT to have charge of this item.

The third of our series of Field Days is to take place on 16/3/47, same conditions, times, etc., as before to apply.

The General Meeting was conducted to a good attendance on 5/3/47. Present being 7LJ in chair, 7BJ, 7CT, 7CW, 7ML, 7RF, 7RY, 7XA, 7GR, 7CJ, 7AL, 7LL, 7YY, 7MY, Messrs. O. Brown, Koglin, R. Harrix, R. Allenby, E. Cruise. Visitor was "Snowy" Harrison (VK3CN). Apologies from 7OM, 7PA, Messrs. Fulton and D. H. Watson.

Correspondence inward.—Contest dope from B.E.R.U. and letters from VK6 and F.H.Q. were received.

New Members.—E. D. Cooper (7MC), S. W. Carter and E. J. Cruise (one full and two associate members) were elected on motion by 7MY, seconded by 7AL, and were duly welcomed to the W.I.A. by 7LJ.

VK5 notes in "A.R." raised a worthy subject in the matter of "Food For Britain" Parcels and it was decided on a motion from 7CW seconded by 7AL, that this Division take some appropriate action.

A "Food Co-ordinator" in the person of 7XA, who volunteered to act, assisted by 7RF, are to handle the organisation of this work. Our present hopes are to forward parcels to

R.S.G.B. for distribution by them as they are in a better position to make the best possible use of them.

A hat around registered the surprising amount of £6 as an initial move and it is hoped to continue this effort from time to time.

7LJ repeated the information on the trip to Launceston given at Council meeting for the information of members present.

Pleasure was expressed at the opportunity of renewing old friendships when 7LJ welcomed our visitor 3CN (ex-7CH) to the meeting. "Snowy," in replying, gave a brief outline of some of the VK3 activities, etc.

7CW has been elected as official U.H.F. Officer for VK7 and hopes to build up an active group on these bands. All interested are asked to contact Crosby.

Launceston and the North—maybe we could have some regular notes seeing as how the gang up there must be active—what say chaps?

During a holiday here last month, Ramsay Bryce (4AB of Ipswich) found time to contact many of the V.I.H. gang. From conversations it would seem that he was needing more than 24 hours to the day most of the time. Glad to have seen you OM.

#### STATE WIDE MEETING IN LAUNCESTON

An almost hundred per cent. but scattered membership had an oppor-

tunity of getting together on 22nd February when amateurs from all over Tasmania paid a week-end visit to the northern city, a reasonably central point in a State where, in spite of its size, one still has to travel some 120 miles in order to do such things.

Arrangements were taken in hand by Col. Wright (7LZ) and other Launceston members whose main regret was, due to rather short notice, their "lack of organisation," a deficiency we visitors did not manage to locate.

The largest single migration was from Hobart, consisting of 7LJ, 7BJ, 7DH, 7CT, 7OM, 7CJ, 7TR, 7GR, 7YY, Messrs. Lipscombe and Durkin—the last two being recent obtainers of the A.O.C.P.—in three cars driven by 7LJ, 7CT and 7YY.

The journey is worthy of note, to the writer's way of thinking, in that exactly two beers were consumed over the whole distance which, in view of the coaching days' legacy of picturesque stopping-places every ten miles or so, deserves mention in anyone's record of irregular phenomena. This was possibly due less to temperate habits than to the effect of ramming eleven people into two small cars after 7YY broke an axle forty miles out.

After stopping for lunch at Tunbridge, we came down into the Tamar Valley around 4 p.m. and reported at

## "RED LINE" AMATEUR TRANSMITTING GEAR

High Tension Plate Supply Power  
Transformer 1500/1500v at  
125 M.A.

Filament Transformer High Ten-  
sion Rectifier 2.5v. C.T. 10A.

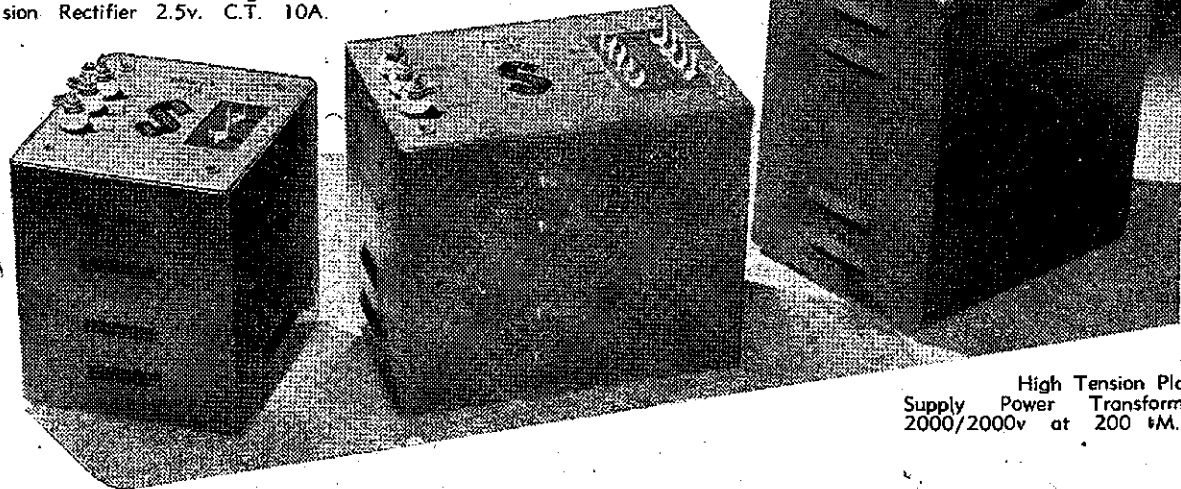

High Tension Plate  
Supply Power Transformer  
2000/2000v at 200 M.A.

Technical Service,  
Wholesale and Manufacturers  
A. T. SWALES  
2 Coates Lane, Melbourne  
Cent. 4773.

Available from  
**SWALES & SWANN**  
and Leading Distributors in all States.

Trade Sales: Allen SWANN,  
157 Elizabeth Street, Melbourne.  
MU 6895 (3 lines)

7LZ. With experience gained on the way up we squeezed into Col's neat little shack where he again apologised for the lack of organisation and proceeded to unfold a story of organising which would have done justice to the Royal Show. Dispersing for a brush-up and tea, we repaired later to Wills & Co. in the Quadrant, where our numbers were added to by 7AB, 7MC, 7DS, 7BQ, Mr. McLean (7LA technician), 7RK, 7RF, 7PW, 7GD, Mr. Crawford, and a visitor from farther afield, 3CC.

Many had not met since before the war, so that things were unofficially in full swing when the meeting was declared open at eight p.m. Mr. Wright welcomed the visitors, on whose behalf Mr. Jensen responded, mentioning that the personal contact well repaid any effort on their part, as would also the greater sharing of Institute matters. Handicapped as we were by conditions which made north-south contacts a comparative rarity, it was important that the pre-war practice of an occasional state gathering be resumed, to which end it was hoped that northern and country members would be well represented at the Annual Dinner.

Mr. Brown gave a resume of Institute activities with particular reference to the need for outlying members' views in formulating proposals for submission to the Federal Convention. Details were also given of efforts that are being made by the W.I.A. generally to have ambiguities and needless restrictions deleted from the P.M.G. regulations.

Proving an able spokesman for the north, Mr. Wright introduced many items of discussion, chief of which were the resumption of all-Australian contests, local distribution of QSL cards together with some suggestions for their handling, and the arranging of a regular round-table of VK7 stations to take the greatest advantage of suitable conditions for intra-state working.

It was decided that for the time being each second and fourth Friday evening in the month should be set aside for a VK7 ragchew on the 7 Mc. band, using phone or cw as each individual station desired, with a recommendation that official transmissions from VK7WI be introduced when it becomes practicable.

A suggestion was made by Mr. Spence that the Tourist Bureau and other organisations might be approached with a view to having QSL cards of some distinctive Tasmanian design provided free.

Around these points and variations too numerous for anyone but a shorthand expert to cope with, all contributed to a general discussion which, one feels, did much to strengthen the ties of a widely dispersed Division. It was flagging but little when the meeting was brought

to a close at eleven p.m. with a vote of thanks to our Launceston hosts and to Mr. Crawford on behalf of Wills & Co. for making the room available.

The following morning was spent in a visit to 7BQ's shack and a general tour around which took in the beauties of Cataract Gorge, after which courses were set for home.

## 50 AND ABOVE

### WESTERN AUSTRALIA

This band has been very active in VK6 during the last month or two, 6LW, 6HM, 6GB, 6SA and 6BK being heard regularly. 6FL, 6HL, 6DD and 6FC all hope to be on very shortly.

Anyone wanting information regarding skeds, gear, etc., for this band are asked to communicate with 6HM who is the 50 Mc. activities manager for VK6.

## FEDERAL QSL BUREAU

guess it will be many years yet before you can hit VK.

The Federal QSL Manager is still desirous of the QRA of any station that can pass cards to VK9, particularly to VK9AZ. Can the VK4 Manager help out? The matter is urgent.

The following QSL Bureau statistics may be of interest. Cards handled at Federal Bureau:—

1931—9,790	1937—43,296
1932—18,333	1938—41,155
1933—18,686	1939—20,962
1934—22,043	1940—310
1935—27,110	1946—23,222
1936—43,707	(Inward only)

The annual call book number of the N.Z.A.R.T. journal "Break In" is an attractive and useful publication. It contains a host of useful information for the amateur, together with a list of N.Z. call signs.

From 12th March, the Victorian QSL Bureau will be taken over by VK3ZB, Graham Roper, 26 Lucas St., Caulfield, S.E.8, Victoria. Graham will handle the domestic metropolitan and country distribution in VK3 and all cards for VK3 stations should be sent direct to VK3ZB. Outward cards from VK3 stations should be sent to VK3OF, Frank O'Dwyer, 190 Thomas Street, Hampton, as at present. Writer will continue as Federal QSL Manager and handle bulk distribution to States of all cards incoming to VK, together with vetting of cards for W.A.C. and other awards.

## FEDERAL NOTES

matter is naturally of interest to Australian amateurs, and as the safety of the expedition depends on radio communication, the Department has requested the co-operation of the

W.I.A. The Divisions have been requested by the Federal Executive to organise watches, and in addition we would suggest that every member who is able should keep an ear open for LI2B.

Incidentally we have already been asked whether this constitutes a new country! We don't profess to know the answer to that, but generally speaking, a country is by nature a fixed object. However, we will be very pleased to give honorable mention in these notes to the first Australian amateur to contact LI2B. Beyond saying that this is one of the most interesting things that has happened in amateur circles for some time, we need hardly stress its importance to the amateur movement.

## FOR SALE, EXCHANGE, WANTED

9d. per line, minimum 2/-

**FOR SALE.**—Owner going abroad, must sell these and other parts. (a) All Band Rx 1500 Kc. to 60 Mc., 4 stages of plug in coils, quite good on 50 Mc., 6AC7 r.f., 6AC7 mix., 6C6 osc., 6K7 regen. i.f., 6B8 2nd det., 6H6 n.s., 6C6 b.f.o., 6J5 and 6V6 audio, ganged bandsread, £20. (b) 50 Mc. Rx, 6AK5 r.f., 954 mix., 055 osc., 2 stages 1600 Kc. i.f. 6K7s, 6B8 2nd det., 6J5 b.f.o., 6V6 output, VR105 regulator, all ganged, £15. (c) Modulator 6C6, 6C6 triode, 6A6, 10-12 watts, £5. VK3NW, 53 Wellington Street, Kew, E.4, Victoria.

**TRANSMITTER FOR SALE.**—All metal rack and panel construction, smart appearance. Three stage Xtal, 807 P.A., bandswitching exciter. Operates on all bands 28 to 3.5 Mc. Has built in antenna tuning unit with panel switching and antenna change over relay. Complete with all coils and crystal. Price £15. Further particulars from D. Kirby, 234 Lords Place, Orange, N.S.W.

**RADIO MAST FOR SALE.** Oregon Mast, approx. 70 feet, two pieces, stepped half way, shaped and tapered. Complete with stays, aerial wire, erection gear, and base plate. Price £15 as stands. Inspection at following address: H. Williams, 21 Lord St., Caulfield, S.E.9. Further information Phone MY260, Ext. 687.

**EXCHANGE.**—Require 100TH, 35T or 35TG. Will exchange unused 813, unused pair 15E, unused pair 15R or quantity 1852. Adrian Miller, VK3AH, 2 Logan Street, Canterbury, E.7. Phone: WF 2138.

**FOR SALE.**—Two 4 mfd. Condensers 2000 VDC, new. G. Sabin, 39 Queen Street, Mosman, N.S.W.

**FOR SALE.**—Gammatron HK24 price 45/-, two RCA 866 20/- each, plate transformer 2000-0-2000 V. at 200 Ma. price £6, or lot for £9/10/-; all are new. Apply B. Falkenberg, BYADUK, Victoria.



## Why 'drift about' looking for RADIO PARTS



Maybe, there'll come a time when you'll be needing urgent replacements or a special addition to that transmitting unit or receiving set. It's then that you remember

## LAWRENCE & HANSON FOR RADIO PARTS

For many years L. & H. have been the regular radio suppliers to hundreds of amateur radio enthusiasts all over Australia.

The experienced 'ham' knows that the L. & H. components are the most efficient, the most reliable AND THE MOST COMPREHENSIVE RANGE OF RADIO PARTS PROCURABLE ANYWHERE.

If L. & H. can't supply those hard-to-get components, it is because they are simply NOT procurable. L. & H. components are guaranteed for years of quality service.

### CHECK THIS LIST OF PARTS RIGHT NOW !

MICROPHONES  
COILS  
BATTERIES  
METERS

SWITCHES  
VALVES  
VIBRATORS  
TRANSFORMERS

CHOKES  
CHASSES  
CONDENSERS  
SPEAKERS

RESISTORS  
LINEFILTERS  
Etc., Etc.

TECHNICAL ADVICE GIVEN ON REQUEST.

Obtain latest lists and prices from your radio house.



**LAWRENCE & HANSON**  
ELECTRICAL PTY. LTD.



33 YORK STREET, SYDNEY  
120 COLLINS STREET, HOBART  
87 ELIZABETH STREET, BRISBANE

172 WILLIAM STREET, MELBOURNE  
60 WAYMOUTH STREET, ADELAIDE  
20 PATERSON STREET, LAUNCESTON

*Are You Looking for*  
**SELECTIVITY?**  
*Then Try the New*  
**"AEGIS" HI-CORE I.F. TRANSFORMERS**

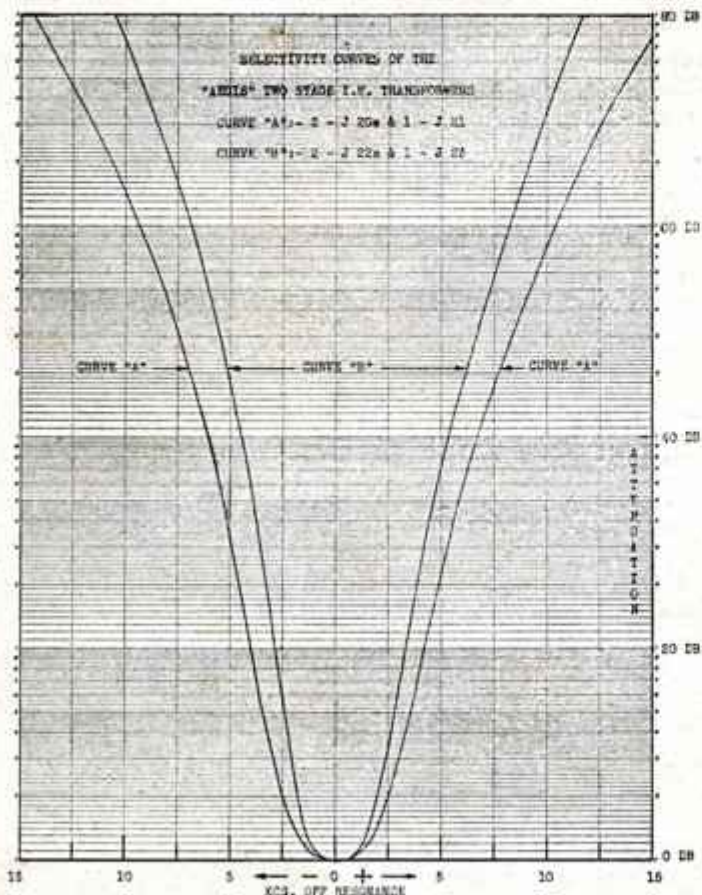

Scientifically Designed  
Expressly for the  
Two-Stage I.F. Channel

INCORPORATING  
THESE FEATURES

1. Maximum Stability
2. Excellent Selectivity, particularly types J22/J23.
3. Effects of Tube Loading reduced to a minimum.
4. "Miller Effect" Detuning eliminated.

Medium Selectivity

Type J20 Interstage Price 13/9 ea.  
Type J21 Diode Price 13/9 ea.

Maximum Selectivity

Type J22 Interstage Price 15/- ea.  
Type J23 Diode Price 15/- ea.

**AEGIS MANUFACTURING Co.**  
 208 LITTLE LONSDALE ST., MELBOURNE



# AMATEUR RADIO

MAY  
1947

JOURNAL OF THE WIRELESS INSTITUTE OF AUSTRALIA

## for your Mixer Socket

A new Frequency Changer Valve — Philips ECH35 — is due for early release. This valve — a triode-hexode type — will be of particular interest to amateurs planning new receivers.

### RATINGS:

Heater volts	.....	6.3
Heater current	.....	0.3 amps.
Plate	.....	250 volts
Plate current	.....	3.0mA.
Neg. grid bias	.....	-2 to -23 volts
Grids 2 - 4 (screen)	.....	100 volts
Screen current	.....	3.0mA.
Conversion Slope	.....	650 $\mu$ A/V.
Plate resistance	.....	1.3 meg.
Osc. anode	.....	100V. 3.3 mA.
Osc. grid current	.....	0.2mA.
Osc. grid resistor	.....	50,000 ohms
Osc. slope	.....	2.8 mA/V.



## PHILIPS

Philips Electrical Industries of Australia Pty. Ltd.  
Sydney — Melbourne — Adelaide — Perth — Brisbane

PL11-44



FOR THE EXPERIMENTER & RADIO ENTHUSIAST

Registered at G.P.O., Melbourne, for transmission by post as a periodical.

6d.



# AMATEUR RADIO

Published by The Wireless Institute of Australia,  
 Law Court Chambers, 191 Queen Street,  
 Melbourne, C.1

**Editor:**

T. D. HOGAN, VK3HX.  
 Telephone: UM 1732.

**Technical Editor:**

J. K. RIDGWAY, VK3CR.

**Notes Editor:**

R. W. HIGGINBOTHAM, VK3RN.

**Distribution:**

H. N. STEVENS, VK3JO.

**Business Manager:**

J. G. MARSLAND, VK3NY.

**Advertising Representative:**

W. J. LEWIS,  
 20 Queen Street, Melbourne. C.1.  
 Telephone: MU 5154.

**Printers:**

H. HEARNE & CO. PTY. LTD.  
 285 Latrobe Street, Melbourne.

MSS. and Magazine Correspondence should be forwarded to the Editor, "Amateur Radio," Box 2611W, G.P.O., Melbourne, on or before the 15th of each month.

Subscription rate is 6/- per annum, in advance (post. paid).

— IN THIS ISSUE —

"Unfolding" the Folded Dipole	3
Federal Notes	7
Such Nice People	11
QSL Bureau	11
Month's DX	12
In Review	12
Fifty and Up	14
Divisional Notes	16
Low Impedance Headphones	24
Radiatron 6AUG	24
Correspondence	24

## EDITORIAL



### DANGER—HIGH VOLTAGE

How safe is your station equipment?

Can you make adjustments to (or perhaps even operate) your transmitter without being incinerated?

There are pages in most handbooks which make reference to the potential lethality of the power supplies of even low power transmitters. How about turning up those pages for a "refresher?"

Is your transmitter installation so arranged to minimise the danger to accidental shock? Is there any possibility of the junior operator becoming entangled in the "haywire," "haywire" that may be "hot?"

Do you rely on a bleeder to discharge your filter condensers or do you discharge them with an insulated screwdriver anyway, because the bleeder may have broken down?

Are there any protruding grub screws on knobs controlling the shafts which are "hot?"

Can you isolate all equipment from the mains by a suitable accessible switch?

Does your station conform with fire underwriters' specifications? You have no claim against an insurance company in case of fire if it can be shown that the underwriters' rules were not met.

The argument that experimental work cannot be carried out with equipment which is nicely dressed up in crackle finish panels complete with a brace of safety devices is foolhardy.

Be sure that the design of all equipment you use is fundamentally safe.

E. D. T.



Have you studied the list of Amateur frequency allocations and types of emission on page 13 of the February issue of "Amateur Radio?" Impressive, aren't they? Frequencies throughout the spectrum, from 3.5 Mc. upwards, and (in the U.S.A. at least) no less than eight types of emission, covering every radio technique currently known.

You know, a decade back, the fellow who worked all bands, and both phone and CW, was not performing any great feat after all. Today—well, there is no escaping the fact that the trend must inevitably be to specialisation, specialisation both in frequency and technique.

But to be effective, this requires the speedy and widespread dissemination of specialised information. That is why, as a first step, the Federal Executive of the W.I.A. recently asked each Division to appoint a V.H.F. officer. That, also is where this Journal can help, but only if you do your bit.

A. H. C.

# MAKE YOUR OWN RECORDS

WITH THE



## JUNIOR RECORDER



### RECORDER AND PLAY-BACK IN ONE

The entertainment and educational value of this unique recording unit are unlimited. Attachable to any radio or amplifier operated from 200-250 volt AC mains, it enables you to make your own recordings on 8 inch, 10 inch or 12 inch blanks and play them back immediately. The



combined recording and play-back head—exclusive to the B.R.S. JUNIOR—records and reproduces perfectly all spoken and musical sounds. The B.R.S. JUNIOR is powered by "Synchro Silent" synchronous motor used by most Australian radio stations, all traversing mechanism is enclosed and dust proof, and the rim-driven, machined aluminium turntable ensures a perfect, constant speed of 78 r.p.m.

With the B.R.S. JUNIOR you can make a permanent recording of all family gatherings, Weddings, Birthdays, Anniversaries; record commentaries for home movies, or mock broadcasts made at parties, birthday and other seasonal greetings for friends and relatives, and open your own recording studio and make real money in your spare times.

Complete with all accessories and guaranteed for 12 MONTHS, the B.R.S. JUNIOR RECORDER is available now from HOMECRAFTS.

CALL, WRITE OR PHONE FOR FULL DETAILS

# HOMECRAFTS PTY. LTD.

HEAD OFFICE: MELBOURNE: 290 Lonsdale Street, and at 211 Swanston Street. 139 Moorabool Street, GEELONG. 307 Sturt Street, BALLARAT. 100 Clarence Street, SYDNEY. 26 Hunter Street, NEWCASTLE.

HOBART LAUNCESTON BURNIE, TASMANIA.

# "UNFOLDING THE FOLDED DIPOLE"

By K. W. MAGEE (VK3KM), A.M.I.E.E., M.I.R.E. (Aust.)

One "rag" which has been much "chewed" of late months, especially among 10-meter addicts, is the impedance transforming property of the folded dipole, particularly with reference to its use in matching the low feedpoint impedance of a three or four-element close-spaced parasitic array as normally used for rotary beams. The writer had considerable discussion on this matter with various people before putting up his own beam and had just commenced to take a renewed interest in the matter, because of the opportunity for changes offered by the temporary dismantling of said beam, when the article by George Choules (VK3AHB) appeared in February "Amateur Radio."

The action of the simple folded dipole is fairly well understood by now and as is also the action of those folded dipoles of more than two elements of identical cross section. The accepted views are clearly and concisely given in the extract from Carter's original article quoted by VK3AHB, and in the relevant portions of his article. (Further references concerning such dipoles are: "Multi-Wire Dipole Antennas," J. D. Kraus (WBJK), Electronics Jan. 1939, and R.S.G.B. "Amateur Radio Handbook," second edition, p. 204.) The point around which most discussion now centres and to which VK3AHB applied himself, was the action of folded dipoles of two dissimilar elements. VK3AHB based his treatment of the dipole with elements of unequal diameters on the assumption that (quoting George), "the (total) centre current will divide in proportion to the conductivity or sectional area of each conductor." This statement at once met with much sales resistance in the mind of the writer, for the following reasons:—

(a) As VK3AHB himself points out later in his article, the current in the conductors travels mostly on the surface of the conductor since we are dealing with r.f. currents. He states, however, that this does not affect the validity of his treatment although the latter requires the conductivity to be proportional to "sectional area" (i.e. to diameter squared). Now, a moment's thought will show that the surface area of a cylinder is in linear proportion to the diameter and if the current travels on the surface, one would, at first sight, imagine that the conductivity (for r.f.) should similarly be proportional to the diameter, unless the penetration depth changes. Further consid-

eration, moreover, will show that increased diameter will not affect the depth of penetration of the material by the current, since the ratio of r.f. resistance to d.c. resistance increases linearly with diameter. We find, therefore, that the r.f. conductivity is not proportional to area (or diameter squared), but is definitely proportional to the first power of the diameter, so that doubling the diameter will increase the conductivity by a factor of 2 and not by 4.

(b) In any case, the conductivity (even at r.f.) of a simple aerial, has very little effect in determining the current flowing in it—again, as VK3AHB himself points out, in a simple aerial, the current  $I = \sqrt{W/R}$  where W equals power supplied and R equals the total effective resistance in which the power is dissipated. Now R includes the r.f. ohmic resistance of the aerial, the equivalent loss resistances and the radiation resistances. Of these the radiation resistance, normally about 73 ohms, is so large in comparison with the others that, for all practical purposes, they may be neglected and the term "R" set down simply as the radiation resistance. It is then apparent that the changes in the distribution of current among the elements of a folded dipole must be related to changes in the effective radiation resistance of the elements and not to changes in the r.f. conductivity.

Now the radiation resistance of a simple dipole in free space is not much affected by changes in diameter of the elements and in a folded dipole, similarly, the radiation resistance of the aerial, as a whole, remains at about the 73 ohms that any one of the elements would have in the absence of the others. This gives us a glimpse of a method of visualising the operation of the folded dipole. Since the current (and thereby the power radiated), is divided between the elements, they may be regarded as a parallel arrangement of radiation resistances which total 73 ohms when treated in the usual manner for parallel resistances. When considering the input impedance, however, assuming that, as usual, only one element is connected directly to the feed line, we must remember that although only the current of one dipole will flow at the feed point, the power for the others must also be supplied there and consequently, the feed point resistance will be higher than the (effective) radiation resistance of the fed element. Let us take an example

here to clarify the picture. In a folded dipole of two similar elements, one of which is fed at the centre, the current is taken as equal, in each element, to half the current required to radiate a similar power from a simple dipole.

Thus, if the power radiated is 73 watts, the total current must be 73

$= 1$  amp., and half an amp. flows 73

in each dipole which has, therefore, an effective radiation resistance of 146 ohms (since the same voltage has produced half the current that flows through 73 ohms). The two radiation resistances are equal in parallel, to 73 ohms. At the feed point, 73 watts are required at a current of  $\frac{1}{2}$  amp., so the feed point resistance

is  $\frac{73}{\frac{1}{2} \times \frac{1}{2}} = 292$  ohms, which is still

OK by VK3AHB. In this case and also in others where elements are all equal, the feed point resistance happens to be equal to the sum of the individual radiation resistances in series and we may be tempted to apply the same treatment in other cases.

But when the elements are unequal, complications set in, since it may be taken that the currents will be unequal and, if we take the case where one element is carrying most of the current, it will obviously have a lower effective radiation resistance, not much more than the 73 ohms of the whole. Now, although the parallel conception still holds for the radiation resistances, it is obvious that we can not simply add the radiation resistances to get the feed point resistance, since this would give a lower feed point resistance with very little current flowing, than in the case where the currents divided equally. Manifestly, this is not a supportable conclusion, and we must find a solution of the paradox. Let us remember the principle on which we find the feed point resistance. It demands that the total power must be supplied at the current flowing in the fed element. It is apparent then that the radiation resistances of the other elements are transformed at the feed point, to that resistance, which, when added to the radiation resistance of the fed element, will make a total resistance such that our power requirement is fulfilled.

We may then set down these relations for any folded dipole:—

- Let  $W$  = total power radiated.  
 „  $I$  = total current in all elements.  
 „  $R$  = radiation resistance of dipole as a whole = 73 ohms.  
 „  $i_1, i_2, i_3$ , etc. = current in individual elements.  
 „  $r_1, r_2, r_3$ , etc. = effective radiation resistances of individual elements.  
 „  $Z_1, Z_2, Z_3$ , etc. = feed point resistance of element used as fed element.

$$W = I^2 R \quad (1)$$

$$i_1 + i_2 + i_3 + \dots = I \quad (2)$$

$$\frac{1}{r_1} + \frac{1}{r_2} + \frac{1}{r_3} + \dots = \frac{1}{R} = \frac{1}{73} \quad (3)$$

$$Z_1 = \frac{W}{(i_1)^2} \text{ or } Z_n = \frac{W}{(i_n)^2} \quad (4)$$

(where  $n$  equals the number of any element.)

$$i_1^2 r_1 + i_2^2 r_2 + i_3^2 r_3 + \dots = W \quad (5)$$

From (4) and (5) —

$$Z_1 = r_1 + \frac{i_2^2 r_2 + i_3^2 r_3 + \dots}{i_1^2} \quad (6)$$

$$= r_1 + \frac{W - i_1^2 r_1}{i_1^2}$$

If you have been patient enough to have reached this point, you will perhaps have a clearer idea of just how a folded dipole gives an impedance transformation and no doubt you will agree that determining the impedance ratio of any folded dipole is very simple when either the current in, or the effective radiation resistance of, each branch is known.

Unfortunately, we still have to find how to arrive at these values in any case of dissimilar elements. We begin to see why these cases are less responsive to simple treatment than those of similar elements, since, in the latter, we can simply assume that the currents and effective radiation resistances are equal and there is no necessity to arrive at their values by any other method than dividing or multiplying the total values by the number of elements. However, with dissimilar elements, we can not use this method and so we must find some other approach which will give us the desired values.

Having reached this point, the writer enlisted the aid of Dr. R. Guertler in a fundamental analysis of the problem. After much discussion, Dr. Guertler produced a most ingenious mathematical treatment which is given, in condensed form, as an Appendix, as it deserves a section all to itself. To be brief (!), this discloses that when dissimilar elements are used, the current distribution and the respective radiation

resistances are governed by two factors, namely, the ratios of the radius of one element to:—

- (a) the radius of the other, and  
 (b) the spacing between them.

These relations are given to an adequate degree of approximation by the expression:—

$$x = \frac{\log \frac{s}{a_1}}{\log \frac{s}{a_2}}$$

where  $s$  = spacing between the elements.

$a_1, a_2$  = element radii.  
 and  $x$  = current ratio.

From the previous articles, we have that the impedance ratio equals  $(x + 1)^2$  and we can now determine, at least to more than sufficient accuracy for practical work, the impedance ratio of a dipole of dissimilar elements. Practical considerations show that the limit of impedance ratio for dipoles of two dissimilar elements is approximately 20 and in most normal constructions the ratio is much less than this.

A case of very common interest, in view of the number of conflicting and erroneous statements made in several publications, is that wherein an impedance ratio of 9:1 is required, e.g. to match a dipole to a 600 ohm line or an 8 ohm beam to 72 ohm co-axial cable. Here the relations may be simplified to:—

$$\frac{s}{a_2} = \frac{a_1}{a_2} \quad (\text{see eq. 9 Appendix})$$

We see that for the usual construction of

$$\frac{a_2}{a_1} = 2$$

to hold good for this impedance ratio, the spacing between elements (centres) must equal the diameter of the larger element, a condition which has not so far been expressed elsewhere.

It is of interest to examine VK3AHB's own beam as an example in the use of our formulae. Taking the figures for the actual elements given in his article,

$$a_2 = .1875 \text{ inch}$$

$$a_1 = .125 \text{ inch}$$

$$x = \sqrt[3]{12} - 1 = 2 \sqrt[3]{3} - 1 = 2.464$$

From eq. 7 (Appendix).

$$\log \frac{a_2}{a_1} = 1.464 \log \frac{s}{a_2}$$

From this we obtain  $s = .25$  inch which is less than the sum of the radii.

This indicates that it is not possible to obtain an impedance ratio of 12 to 1 with the given diameter ratio. Taking the actual spacing used by VK3AHB at  $1\frac{1}{2}$  inches we have:—

$$x = \frac{\log \frac{1.5}{.125}}{\log \frac{1.5}{.1875}} = \frac{\log 12}{\log 8}$$

= 1.19 approx. (eq. 5 Appendix).  
 So the impedance ratio equals—  
 $(x + 1)^2 = (2.19)^2 = 4.81$

How then, can we reconcile this with the apparently small mismatch evidenced by VK3AHB's feedline and the results obtained with his beam? The answer, most probably, lies in that, in adjusting his beam with his folded dipole in place, VK3AHB arrived at a combination of element lengths which gave good forward gain but presented a higher radiation resistance than the normal figure taken for a 4-element beam, i.e. approximately 14 ohms instead of 6.

Study of the various articles on parasitic beams will indicate that to obtain such a value requires very little alteration to the normal element lengths. This is a good example, and timely reminder, of the fact that theoretical treatment of beam antennas must be supplemented by much "pudding-proving" when the ideal free space conditions are replaced by mundane backyards. However, let us now see how we could get the 12 to 1 ratio required if the beam radiation resistance were 6 ohms as per book and we wanted to use  $\frac{3}{8}$ -inch elements and  $1\frac{1}{2}$ -inch spacing. From eq. 7 Appendix:—

$$\left(\frac{s}{a_2}\right)^{x-1} = \frac{a_2}{a_1}$$

$$x = \sqrt[3]{12} - 1 = 2.464$$

$$\text{So } \frac{a_2}{a_1} = \left(\frac{3/2}{3/16}\right)^{1.464} = \text{approx. } 21$$

So our feed element should have a diameter of approximately .019 inch, which can be, in practice, a wire of about 26 s.w.g.

You are, of course, getting ready to ask, "but how are we to know if the radiation resistance of our beams is going to be close enough to the published figures to enable us to use the formulae with any hope of a correct match in practice?" The answer, I fear, is that you don't know it, but if the beam elements are proportioned and spaced correctly as per book, the effective height is really what it should be (this point alone deserves a good deal of study) and there are no major disturbing elements in the

vicinity, and the folded dipole is constructed correctly for the book figure of radiation resistance and the known co-axial impedance, very little pruning will be required to give a very satisfactory antenna, from all points of view and the compass. In any case, it is felt that the mental effort to clarify matters has been well worthwhile, since a reasonable basis for calculation has been provided, based on solid grounds, and after all, I think that is what George wanted to spur someone into doing.

If you have lost your log tables and the slipstick has run a big end, the charts given in the Appendix should save a few splinters under the finger

nails. They will be found adequate for most amateur matching problems.

### EDITORIAL FOOTNOTE

Comments by George Choules (VK3AHB) and discussions arising will be published in the next issue of "Amateur Radio." The Appendix by Dr. Guertler should prove of great interest to those readers who like to reduce cut and try methods to a minimum, while the chart supplied should make life much easier for the constructor anxious to obtain the desired results without overburdening the grey matter.

### APPENDIX

## CURRENT DISTRIBUTION AND IMPEDANCE RATIOS IN FOLDED DIPOLES

By R. GUERTLER, Dr. Tech. Sc. (Brno).

Compare the folded dipole, Figure 1, with the simple dipole Figure 2, of the same physical dimensions. It is obvious that the current and voltage distribution in both aerials is practically identical so long as we deal with the purely oscillating energy (and this is permissible when  $Q$  is high, say, greater than 3, as is the case with all usual diameters). The dipole of Figure 1 differs from that of Figure 2 only in the impedance offered to the feed line. In Figure 2, we have in each plane  $p_i$ , normal to the aerial equal potentials on both conductors. This statement is obviously true for the driving points A and B and for the ends E and F (neglecting the complications due to the end effects, etc.). It follows, logically, that it holds for each plane  $p_i$ , since the potential distribution of the aerial as a whole is common to both portions.

It is convenient to analyse the current distribution by determining the ratio of the charges on the two conductors in any such plane  $p_i$  at the moment when the current is zero and the charges have momentarily no motion—i.e. the instant when the voltage is at maximum value. By so doing, we need not consider the effects of the magnetic field. (At the other limiting condition, viz., maximum current and zero voltage, the same total amount of energy is now existing in the form of magnetic field and an analysis produces practically the same result, so long as  $Q$  remains reasonably large. At other times, we have a composite function determining the potentials, but the assumption of a sinusoidal variation implies that the relations will hold.)

Equal potential is obtained only when the larger diameter aerial (see Figure 3), takes more charge—i.e. carries a larger current. (Current

equals the rate of change of the charge.) This can be seen from the following reasoning. The construction of the folded dipole enforces equal potentials on both conductors at the ends since they are connected together. The construction of Figure 2 ensures further equal potentials at A and B and, in consequence, in each plane  $p_i$ . The equal potential on the surface of both conductors in each plane  $p_i$  is the primary condition from which arises, as a consequence, the corresponding distribution of charge.

For the computation of the ratio of the charges, we consider Figure 4. The total charge  $q_1$  of a thin section of the left aerial, we replace by an equal charge in the point  $Q_1$ , so chosen as to give the same potential in an arbitrary point P in the plane

$p_i$ . The total charge  $q_2$  of a thin section of the other conductor, we concentrate similarly in a point  $Q_2$ . This substitution is an approximation only, but the error is small for  $d_2$  less than 0.6s where  $d_2$  is the larger diameter. In these cases, the points  $Q_1$  and  $Q_2$  are at negligible distances from the centre points of the respective elements. The potential component in the point P due to  $q_1$  at  $Q_1$  is known to be  $-2q_1 \ln r_1/ro$  and the potential component due to  $q_2$  at  $Q_2$  is, similarly,  $-2q_2 \ln r_2/ro$ ,  $ro$  being a constant. The sum of both components is the total potential U at the point P.

$$U = -2q_1 \ln r_1/ro - 2q_2 \ln r_2/ro \quad \text{eq. .... (1)}$$

The ratio  $x$  of the two charges and thus, of the currents, is:

$$x = \frac{i_2}{i_1} = \frac{q_2}{q_1} \quad \text{.... (2)}$$

If we put for convenience

$$\frac{-U}{2q_1} = -u, \quad ro = 1, \quad \text{we get,} \\ r_1 r_2^x = e^{-u} \quad \text{or} \quad \ln r_1 r_2^x = -u$$

We stated that all points of the surface of both conductors are of equal potential. As representative points, we choose  $P_1$  and  $P_2$  in Figure 4. If

$$\frac{d_1}{2} = a_1, \quad \frac{d_2}{2} = a_2,$$

we get from (3) approximately  $e^{-u_1} = a_1^x$  for the point  $P_1$ , and  $e^{-u_2} = s a_2^x$  for the point  $P_2$ . Our conditions are satisfied if  $u_1 = u_2$  or

$$a_1^x = s a_2^x \quad \text{.... (4)}$$

where  $x$  = current ratio

- $a_1$  = radius of one element
- $a_2$  = radius of other element
- $s$  = separation (between centres).

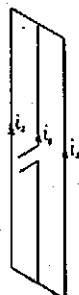

Fig. 5.

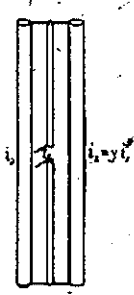

Fig. 7.

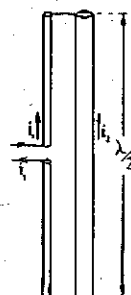

Fig. 1.

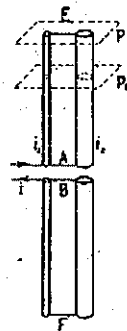

Fig. 2.

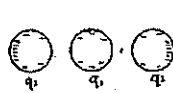

Fig. 6.

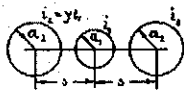

Fig. 8.

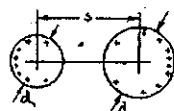

Fig. 3.

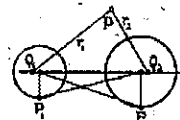

Fig. 4.

From this equation, we get the current ratio  $x$  if the physical values are given:

$$x = \frac{\log s/a_1}{\log s/a_2} \dots \dots (5)$$

It is immaterial whether we use natural or decade logarithms. Chart 1 may be used to apply eq. 5 without calculation. The feed point impedance for the folded dipole is derived from the power relation between Figures 1 and 2.

$i_1 Ri = (i_1 + i_2)^2 Ro$ , where approximately  $Ro = 73$  ohms,

$$Ri = \left(1 + \frac{i_2}{i_1}\right)^2 Ro = (x + 1)^2 Ro$$

ohms  $\dots \dots \dots$  (6)

A more usual task than the above-mentioned one arises when a certain input resistance,  $Ri$ , is required and the total radiation resistance,  $Ro$ , is known. In consequence, an impedance ratio  $Ri/Ro$  is required. We have a fairly wide choice of a ratio of two dimensions, e.g.  $s/a_2$ . From eq. (5) or chart 1 we obtain the other ratio, i.e.  $s/a_1$ . In other words, we have the choice of two values and the third has to satisfy eq. (4) or (5). A simple transformation of eq. (4) provides us with the more convenient chart 2 which represents:—

$$\log a_2/a_1 = (x-1) \log s/a_2$$

$$= (\sqrt{Ri/Ro} - 2) \log s/a_2 \dots (7)$$

because the current ratio

$$x = \sqrt{Ri/Ro} - 1, \dots \dots (8)$$

as eq. (6) shows. For a current ratio  $i_2/i_1 = 2$  or  $Ri = 9Ro = 660$  eq. (7) is simplified to  $a_2/a_1 = s/a_2$ .

For example:  $s/a_2 = 4$  or  $s/d_2 = 2$  requires (for  $x = 2$ ),  $a_2/a_1 = 4$ , i.e., the larger diameter is four times the smaller.

The treatment of other aerials of this type is similar, and incidentally, explains why the dipole of type Figure 5 has been found in practice to have a driving point impedance somewhat greater than  $9Ro$ . If we consider that the potentials on the surface of each conductor in the same plane  $p_1$  must be equal, we realise that the middle conductor (Figure 6) takes a smaller charge  $q_1$  than either of the outer conductors. Consequently, the current  $i_1$  is less than  $i_2$ . Of course, it is possible to get equal currents if we increase properly the diameter of the inner conductor or arrange the three elements in a triangular disposition so that they are at equal distances from each other.

But this effect may be turned to practical use since it provides a means of obtaining impedance ratios which are higher than can be obtained with a convenient diameter ratio in the construction of Figure 1, but which are

not equal to the square of some integer and therefore are not amenable to solution by the use of equal elements suitably arranged. In these cases, the construction of Figure 7 may be used, and, by a similar treatment, we can show that the relations pertaining are (see Figure 8):—

Impedance ratio (centre element fed):—

$$\frac{Ri}{Ro} = \left(\frac{2i_2 + i_1}{i_1}\right)^2$$

$$= (2y + 1)^2 = (x + 1)^2 \dots (10)$$

$$\left(\frac{s}{2a_2}\right)^y = \frac{s}{a_1} \dots \dots (11)$$

$$y = \frac{\log \frac{s}{a_1}}{\log \frac{s}{2a_2}} = \frac{\log \frac{s}{a_1}}{\log \frac{s}{a_2} - \log 2}$$

eq.  $\dots \dots \dots$  (12)

$$y - 1 = \frac{\log \frac{2a_2}{a_1} \log \frac{a_2}{a_1} + \log 2}{\log \frac{s}{2a_2} \log \frac{s}{a_2} - \log 2}$$

eq.  $\dots \dots \dots$  (13)

Taking examples, we find that for equal currents in three elements in line, Figures 7 and 8, the centre element must have twice the diameter of that of the others, and that for three equal elements in line, the current ratio is dependent on spacing. Also, the equivalent of a pentagonal arrangement of 5 equal elements i.e. a 25 to 1 impedance ratio, is obtained when

$$\frac{2a_2}{a_1} = \frac{s}{2a_2} \dots \dots (14)$$

or, in other words, when the ratio of spacing to the diameter of the outer elements equals the ratio of outer element diameter to centre element radius.

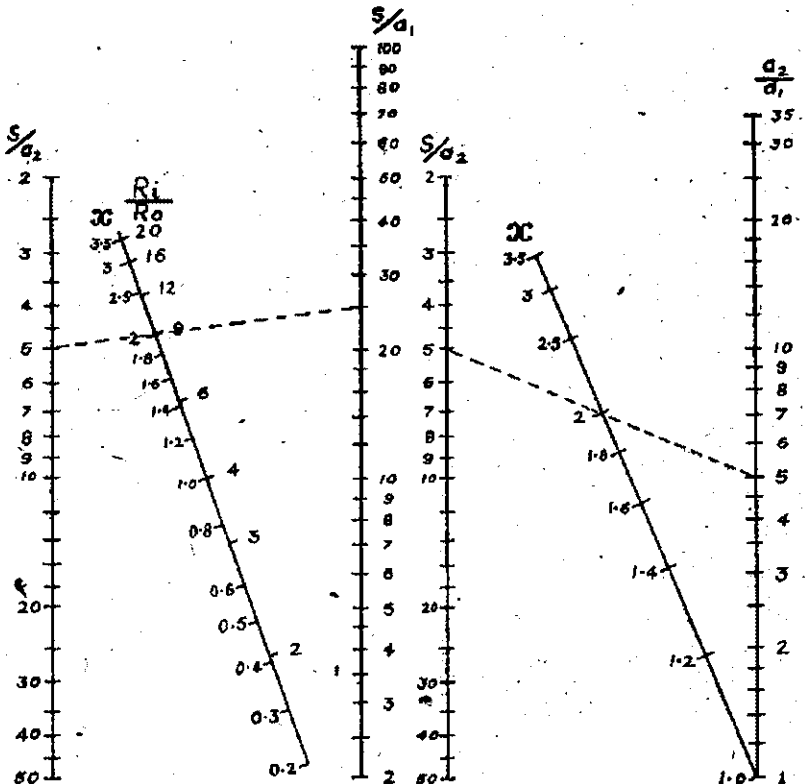

Chart. 1.

Chart. 2.

A straight edge laid across the scales will intersect corresponding values of spacing-radius ratio,  $s/a_2$

or  $s/a_1$ , current ratio  $x$ , impedance resistance transformation ratio  $Ri/Ro$  and radius ratio  $a_2/a_1$  as indicated.



## FEDERAL NOTES.

# 1947 CONVENTION

We are pleased to give you this month a brief review of the Federal Convention held in Melbourne from 4th April to 7th April, 1947, including the opening addresses and the Federal President's Report, and the Financial Statement. Next month we will be able to present a precis of the motions arising from the Agenda.

The first session of the Convention was declared open by the Federal President, Mr. Vaughan Marshall, who called on the Federal Vice-President to welcome the visiting delegates, who were Mr. J. B. Corbin (2YC), Mr. W. Gronow (3WG), Mr. H. E. Sprenger (4ES), Mr. E. A. Barbier (5MD), Mr. G. A. Moss (6GM), Mr. J. Brown (7BJ).

Mr. R. J. Marriott, Federal Vice-President, said that on behalf of the Federal Executive he took great pleasure in welcoming the delegates, and said how pleased he was to see a delegate in attendance from each State. Mr. Marriott said that the Federal Executive had done quite a deal of work since the last Convention and he hoped that the delegates would consider that it had been done

to the satisfaction of the Institute.

The Victorian delegate seconded Mr. Marriott's remarks. Mr. Gronow also welcomed the delegates on behalf of the Victorian Division and said that he was hopeful that the delegates would have a profitable and happy time, and it was hoped that it would be possible to intersperse some of the serious business with social items and so break the monotony of the task. He felt certain that the Convention, from his Division's point of view, would be one of the most important yet held, and it was hoped that the results achieved would mark milestones in the history of the Institute. Mr. Gronow said further that he felt that his second year of post-war radio was one of great importance. He thanked the Federal Executive for their efforts and for the multitudinous tasks they had undertaken, and said that the results achieved had been great.

Mr. E. A. Barbier, in responding on behalf of the delegates, said that he, having been present at the previous Convention, had a fair idea of the amount of work done by the Federal

Executive, and said that his Division appreciated it. He said that he was sure that this Convention would be equally important with the last one, and it was the earnest desire of his Division to co-operate with the other Divisions and to further the cause of Amateur Radio.

At this stage nominations were called for the office of Chairman of the Convention, and the Federal President was elected unopposed. Mr. Marshall, in the capacity of Federal President then presented the Annual Report of the Federal Executive:—

### ANNUAL REPORT

The past twelve months has been a period of consolidation for the Wireless Institute, and considerable progress has been made, both by Divisions in the organisation of their domestic activities, and Federally in the overall control of reconstruction involved that there should have been difference of opinion concerning methods and procedure, and a feeling that progress was not being sustained at a high enough rate. However, after surveying the year's activity both in the Federal as well as the Divisional field, it is with no sense of complacency that your Executive feels that the year has been a satisfactory and progressive one for the W.I.A.

# VEALL'S

## Calling All Radio Hams Here's a really super Multimeter

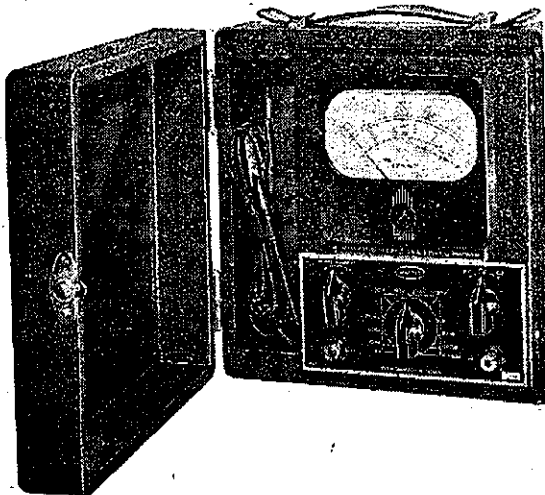

**UNIVERSITY MULTIMETER**  
**£11/2/- (Plus Tax)**

University Multimeter, Model M.V.A. (AC-DC). A new precision Multimeter, favourite alike with radio service engineer, hobbyist, and industrial engineer. This instrument will make your service work easy.

#### DISPOSAL BARGAINS

Army Type- 11 Sets  
(Less Valves) .. £5.  
Army Type 19 Sets  
(Less Valves) £4/10/0

#### SOUTH OF THE YARRA HAMS

Keep on the Beam by  
making our Prahran  
Store your headquarters.  
Contact VK3FR (Fred  
Smith)

RADIO and REFRIGERATORS

# VEALLS

ELECTRICAL AND LIGHTING

*Sales and Service*

MELBOURNE: VEALLS (SWANSTON ST) PTY. LTD  
240 SWANSTON ST. MELBOURNE

PRAHRAN: VEALLS (PRAHRAN) PTY. LTD  
258 CLARE ST. PRAHRAN

MAIL ORDERS: BOX 21417

Telephone F 5185

In the Federal sphere, the progress made has resulted in large measure from the very clear mandate and statement of policy laid down by the Federal Council at the 1946 Convention, and the clarity of direction accorded the Executive, can be commended to this Conference. It is desired to report and comment on the major matter handled by your Executive during the past year, as follows:—

#### P.M.G. DEPARTMENT

Your Executive has maintained a very cordial relationship continuously with Officers of the P.M.G. Department throughout the year. There have been a considerable number of matters on which we were instructed to negotiate with the Department, and there has been a free expression of views on both sides. Although the Department has not subscribed to the W.I.A. attitude on all matters, excepting those which are still under review, on no subject of major concern except the return of 7200-7300 Kcs. has agreement not been reached. At all times your Executive has stressed the importance of reducing the number of restrictions to the minimum.

Some difficulty has been experienced during the year owing to the fact that varying interpretations of Regulations have been made by local P.M.G. Administrations in the various

States. In practically all cases the difficulties were speedily resolved. Your Executive believes that such problems will be overcome in the forthcoming year.

#### FEDERAL EXECUTIVE ADMINISTRATION

The volume of work to be handled by the Executive has now reached proportions beyond the capacity of a small body of members acting in an honorary capacity. During the past year the Federal Secretary has handled 443 separate communications in addition to the Minutes of 27 meetings, and all the many and various matters that fall to the lot of a Secretary of an active organisation as the W.I.A. Your Executive has handled 117 items of importance to the Australian Amateur during the year, and has completed action on all relevant matters referred to it by the Federal Council. Despite the best endeavours of the members of the Executive, Divisions have not been as closely in touch with current Federal activities as either the Divisions or the Executive consider desirable. This matter as well as consideration of means whereby a paid officer may be added to the Federal staff are subjects your Executive commends to this meeting of the Federal Council as of special importance.

#### TECHNICAL DEVELOPMENT

While the Executive has been forced to concentrate in the main on W.I.A. administrative matters, during the past year, as the W.I.A. is still engaged on consolidating its organisation to meet post-war conditions, considerable thought has been given to the importance of setting up a program of technical development and providing the necessary co-ordinating machinery for inter-Divisional activities. There are possibly more untapped fields of experimental radio activity available today than ever before, and your Executive believes it is of the greatest importance that a virile program of research and experimentation be drawn up, and technical assistance provided to the many experimentally minded amateurs. A start has been made during the past year, but there is a great deal of work still to be done.

#### DEFENCE RADIO RESERVE

Negotiations with the R.A.A.F. have been carried on, with a view to reconstituting the R.A.A.F. Radio Reserve. The W.I.A. has been requested to prepare a broad plan as a basis of discussion and preliminary work has been carried out thereon.

#### I.A.R.U.

Your Executive has maintained close contact with the I.A.R.U. during the past year. The most important activity has been related to the forthcoming International Telecommunica-

## TECHNICAL BOOK & MAGAZINE CO.

297-299 SWANSTON STREET, MELBOURNE

(Opposite Old Melbourne Hospital)

Central 2041, Melbourne, C.I

We can arrange subscriptions to any of the following magazines:

#### AMERICAN.

RADIO: .....	25/- year	COMMUNICATIONS: .....	24/- year
Q.S.T.: .....	27/- "	RADIO NEWS: .....	40/- "
C.Q.: .....	25/- "	RADIO CRAFT: .....	22/- "
SERVICE: .....	24/- "	SCIENCE DIGEST: .....	23/6 "
F.M. & TELEVISION: .....	48/- "	PROCEEDINGS INST. OF RADIO	
ELECTRONICS: .....	97/6 "	ENGINEERS .....	88/- "
SPECIAL RATE FOR THREE YEARS: ..	195/-	POPULAR SCIENCE: .....	23/6 "
		POPULAR MECHANICS: .....	23/6 "

#### ENGLISH AND AUSTRALIAN.

WIRELESS WORLD: .....	25/- year	WIRELESS ENGINEER: .....	42/- year
PRACTICAL WIRELESS: .....	13/6 "	ELECTRONIC ENGINEERING: .....	33/- "
AUST. RADIO WORLD: .....	10/6 "	RADIO AND HOBBIES: .....	6/6 "
AMATEUR RADIO: .....	6/- "	SHORTWAVE MAGAZINE (English): ..	25/6 "

FOREMOST IN AUSTRALIA FOR TECHNICAL BOOKS.

tions Convention and the fullest possible information on the Australian situation has been forwarded to the Amateur Delegation appointed to represent the I.A.R.U.

### CONTESTS

As directed by the Federal Council, an International Contest was organised but owing to the limited time available it was not as well patronised as usual. Arrangements have been made with N.Z.A.R.T. for reviving the regular VK-ZL contest in 1947, and action has been taken with the I.A.R.U. to reserve the month of October as in pre-war years. The Contest Manager's report on the year's activities is tabled herewith.

### "AMATEUR RADIO"

Negotiations have been carried on with the Victorian Division as directed by the Federal Council, to determine a satisfactory formula for taking over "Amateur Radio" by the Federal Council. The basis agreed upon is submitted to this Convention for ratification.

The Magazine has been carried on by the Victorian Division during the year on the understanding that the Editorial Policy was under the control of the Federal Executive. The amount of work involved in publishing the Magazine is a heavy burden for personnel working in an honorary capacity, and this aspect requires very careful consideration when this Convention is examining the possibility of providing a paid officer to handle Federal Activities under the direction of the Federal Executive.

### FINANCE

The Treasurer's statement of Receipts and Expenditure is attached herewith. The present level of capitation is inadequate to handle the scope of Federal activities on the scale required, and an examination of this subject is a matter of some consequence to this Convention and the expanding level of Federal activities.

### CONCLUSION

At the present time the W.I.A. is in the strongest position in its long history. With the overhaul of Federal machinery at this Convention, with the modification of certain P.M.G. Regulations governing Amateur Radio in Australia, and with the limitless field of experimentation open to members, the W.I.A. can look forward with confidence to turning the brightest pages in its history. With pride in the past, and keen anticipation for the future, we can set our feet on the road which will turn the potential opportunities of today into the accomplishments of tomorrow.

### STATEMENT OF RECEIPTS AND EXPENDITURE

At the conclusion of the presentation of the Annual Report, the Federal Secretary, on behalf of the Federal Treasurer, who was unable to be present, read the Statement of

### Receipts and Expenditure.

Receipts	
Balance at 1st April, 1946	£19 1 8
Per Capita Contributions from Divisions:—	
N.S.W. ....	£28 2 6
Victoria .....	12 0 0
Sth. Aus. ....	4 12 0
West A. ....	3 10 0
Tasmania .....	2 17 0
	51 1 6*
	£70 3 2

Payments	
Convention Minutes .....	£10 10 0
Convention Expenses .....	2 14 9
Postage .....	5 12 7
Petty Cash .....	6 4 9
Printing and Stationery .....	8 8 3
Telegraphic Address .....	2 2 0
QSL Postage .....	1 4 2
Cheque Book and Exchange .....	6 0
	£37 2 6
Balance at 31st March, 1947 .....	33 0 8
	£70 3 2

"I have examined the above statement of the Receipts and Expenditure of the Federal Executive of the Wireless Institute of Australia for the year ended 31st March, 1947, and having obtained all the information and explanations required I am of the opinion that the transactions for the year are properly recorded therein. No per capita contribution has been received from the Queensland Division during the year and receipts have not been produced for the payment of £10/10/- to A. Brown for Convention Minutes or £1/17/- to Geo. Raitt & Co. for stencils."—L. T. Powers, Chartered Accountant (Aus.) Hon. Auditor, 3/4/47.

The Annual Report and the Financial Statement were duly received and adopted by the Convention, which then began consideration on the Agenda. Consideration of the Agenda and the various items of general business occupied the Convention very fully until after mid-day on Monday, 7th April, when the Convention was formally declared closed by the Chairman.

The West Australian delegate (Mr. G. Moss) moved a vote of thanks to the Federal Executive for the work done during the year, and to the Chairman for his excellent handling of the business of the Convention. The New South Wales delegate (Mr. J. B. Corbin), in seconding the motion, said that for the first time in the history of the Institute the W.I.A. had functioned truly as a Federal body and every possible action had been taken by the Federal Executive to see that the Federal Council functioned efficiently. Mr. Corbin said that the Federal Executive had carried out their duties in a way un-

equalled in the past, and that all members should take time to consider what they owed to these people.

The remaining delegates expressed similar sentiments in support of Messrs. Moss and Corbin, and at the conclusion of their remarks the Federal President thanked the delegates for the interest they had shown in their task, and expressed his personal appreciation of the co-operation he had received during the past year from his colleagues of the Federal Executive.

# Bright Star Radio

K. G. ALLEN  
VK3UH, Late R.A.N.

1839 Lower Malvern  
Road, Glen Iris, S.E.6  
Victoria

Phone: UL 5510

Prompt deliveries to oil  
States.



As Illustrated  
40 or 80 metre  
AT or BT cut.  
Accuracy 02%  
of your specified frequency,  
£2/12/6

Large unmounted 80 or 40  
metre, zero drift cut, £2;  
mounted 7/6 extra.  
20 metre, zero drift mounted  
£5.

Crystals reground, £1 each  
Taylor Transmitting Tubes  
in the following types  
available soon: T20, T21,  
T40, TZ20, TZ40, T55,  
TB35, 866 JR. Place  
your order now.

Data sheets on request  
Filament, Power and Modu-  
lation Transformers made  
to order. Reasonable Prices  
Prompt Deliveries.

# THE BAROMETER OF WORLD OPINION

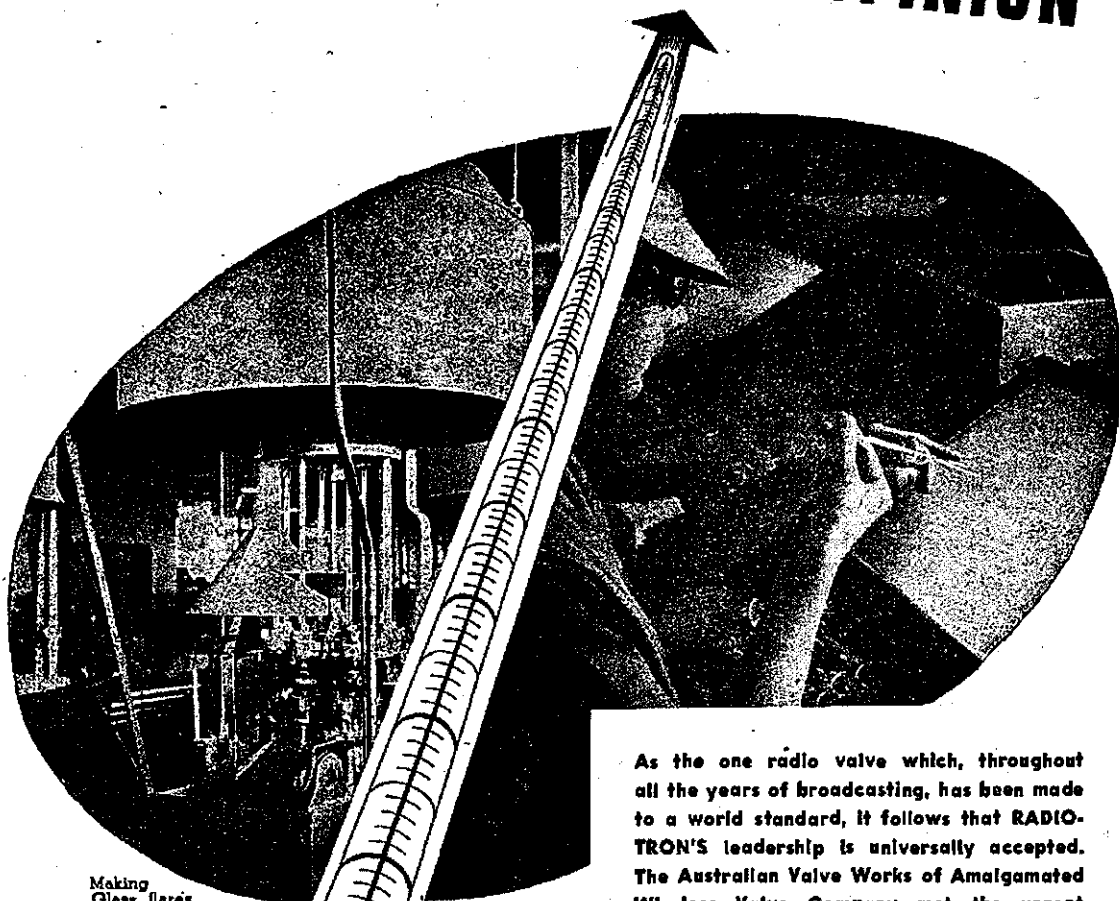

W.S. Making Glass flares for radio valves . . . . .

Examining flares over an illuminated screen.

As the one radio valve which, throughout all the years of broadcasting, has been made to a world standard, it follows that **RADIO-TRON'S** leadership is universally accepted. The Australian Valve Works of Amalgamated Wireless Valve Company met the urgent needs and uncompromising standards of defence throughout the war — the same organisation, to-day, is increasingly competent to provide the growing needs of peace.

W.S. **AMALGAMATED WIRELESS VALVE COMPANY PTY. LTD.** 53



Administration — 47 York Street, Sydney, N.S.W.  
 Manufacture — Parramatta Road, Ashfield, N.S.W.  
 Distribution — Crown Street, Glebe, N.S.W.

V2

# SUCH NICE PEOPLE

By "GREMLIN"

Honours this month go to 4HR for a nice long-haul job on 50 Mc. What is 2NO going to do about this? To battle Don, VK2 depends on you!

My booby prize was going to 3RW. How do you do it OM? I never could get a note that bad for the choicest bit of DX, but 3UH has gone several better. I can't believe it Ken—or describe it. However the time was 1000 E.S.T. on 5th April. Maybe it was a pirate, would like to know because your note has always been pretty good.

5RL, you and I aren't playing speaks. After all those nice things I said last month, Ross turns around and produces some hefty background music. "Singing Polly-Wolly-Doodle" of all things!

3ABG is also a music fan. Quite a long item on the Harp—refugee type—or something, much to the disgust of 3UL. I'm not joining the argument between you chaps on the legitimacy of putting over various musical instruments for test purposes. However, I do agree with 3UI that it is not any help on our over-crowded bands, and that should be sufficient inducement to refrain. That goes for Des too!

A 60 watt globe coupled to the final tank makes a good dummy aerial that shouldn't be outside the means of any Ham. Admittedly some blokes would need three or four in series but it is still pretty cheap and saves a lot of needless QRM.

3JD might consider the dummy aerial question. A session of whistling, mixed with background noise of numerous children, was hardly entertaining. The only reason I listened for five minutes was to hear your call. Apparently you were trying to convince sundry people you don't overmodulate. My views haven't changed. There is one thing OM, the hum does go down when you speak so I guess that's something.

2NY is putting out some decent key clicks but I think the matter is in hand. A key fiend with a fone yearning, Roy!

3GU, another dyed in the wool c.w. man, has been bitten by the fone bug. There is one thing, when these c.w. old timers go for fone, they usually produce a fair quality sig. And that is probably because they have the r.f. side cleaned up before they start modulating the carrier.

3ADS might take a tip here. Your fone is about as good as your cw, Ron.

2CL also produces a nifty click, but haven't heard of anything being done about it.

Congrats to the various Divisions on their efforts for the "Food for Britain" appeal. Believe the latest in line is the VK3 gang. An auction of bits and pieces, ably conducted by Ray Ohrborn (3OC), and a whip around at the last meeting produced approximately £20 for the cause. By the way Ray, about time you made a comeback on the air. What's wrong, lost your cat's whisker?

Congrats Dave, 2EO, on your DX Contest win. What do the beam believers say about the Zepp now?

Glad I don't live too close to 4WF. Bad enough a few hundred miles away when you turn the wick up, and that is usually when the DX is at its best. I guess the temptation is too great. 4HG is another with a mighty splash.

The c.w. boys seem to leave the high end of twenty to the fone gang during DX hours. Not so the reverse. A quick run over the band the other night produced 2CW, 2SV, 2JN, 2TE, 3ADR, 3EV, 4WF, 5RC, 6PW and 6WG all on the low end with fone. DX was good at the time. Woodpeckers I could make a suggestion, but I guess that would be considered vindictive. Perhaps the day will come when we will find it necessary to divide the band, or maybe wisdom and consideration will prevail.

By the time this hits print the shouting and tumult of the Federal Convention will have died and many wiser and happier delegates will have returned to the wolves. Me thinks this 17th Convention will be one out of the box. Time will tell.

Think over this one heard recently. "Running 25 watts to p.p. 807s, modulated by p.p. 807s in AB." How long does a torch battery last as a d.c. supply for the modulators?

Editor's Note.—The following are extracts from letters received during the month. Apparently "Gremlin" has a few supporters.

"Like you, I welcome the appearance of 'Gremlin' (bet he was a blue orchid?), although I must admit that of the half dozen brethren QSO'd today, one did not appreciate the aforesaid 'Gremlin.' Perhaps someone's conscience is not too clear—or is it just lacking in a sense of humor?"

"I am very pleased to see 'Gremlin' on the job. It has been 'in my hair' for a long time the operating 'behaviour' of many of the Hams on the bands these days. May I suggest he starts two sections in his article. (1) The 'bath' section for Hams whose signals splash over various sections of the band, phone and c.w. (2) The 'abrasive' section for poor c.w. notes and bad distorted phone. Just a list of calls I think should suffice."

# FEDERAL QSL

## BUREAU

RAY JONES, VK3RJ, MANAGER

The R.E.F. have requested that all QSL matter be sent to the QSL Manager at the following address in lieu of the address of the Society:—Service QSL R.E.F., 48 Rue St., Laurent, Lagny, (S. & M.) France.

VK3GE, ex-VK4EY, has returned to Victoria and is located at Balcombe. Glad to hear of your return George. George is also an ex-Tasmanian.

The address of the QSL Bureau for Colombia is:—Colombia QSL Bureau, P.O. Box 584, Bogota, Colombia.

The correct address for QSL matter for Egypt is:—Hal Frost, SUIHF, Box 360, Cairo, Egypt. Hal, the QSL Manager, is ex-W6IAQ.

The address of PK6VR for QSL purposes is:—PK6VR, L. D. Rickaby, Australian Radio Operatio, Biak Isld., Dutch New Guinea, care 19th Squadron Archerfield, Brisbane. Bit of a mouthful but is in order. The station is operated by VK4VR and will cease to exist on 26th May, 1947.

The French broadcasting authority has requested the R.E.F. to solicit reports on the reception of the short wave broadcasts of the authority. The station will use the call sign TPA on all broadcasts which will consist of simultaneous transmissions in morse and telephony on a number of frequencies between 7240 and 17850 Kc. The stations will commence operation on May 7 and continue until November 7, 1947. The transmissions will be continuous excepting between 0445 to 0530 G.M.T. Listeners and others interested can obtain full transmitting schedules and frequencies from this Bureau and reports on reception should be addressed to the R.E.F., 1 Rue des Tanneries, Paris 13, France.

Bob Rowley, HP4Q, writes to say that he is under cover, and QSLs for him should NOT be sent via HP1A but should be sent either direct or via A.R.R.L. He mentions he worked many VK stations pre-war, but did not think his present small rig would be able to get through to VK, but it does.

Am indebted to BERS 195 for a further bunch of rare addresses. They include BA4ZE, F2GB, VU7JU, VP4TB, VP4TX, LI2JC, UC2AD, OESAA, J9RCP, K6ETF/K6, VR4AA, SUIUS, ZM6AC, PK6EE, KG6AD. Anyone wanting any of these may have same on application.

The QSL address for Fiji has been amended to VR2UH, D. A. Leslie, P. and T. Department, Suva, Fiji. Cards should NOT be sent to Box 237 any longer. Fourteen amateurs are licensed to date in Fiji, call signs ranging from VR2AA to VR2UH.

# MONTH'S DX

## WESTERN AUSTRALIA

**28 Mc. Phone.**—Band is still patchy but showing considerable improvement as weeks go by, particularly week-end of 22nd and 23rd March.

**Europe.**—Some excellent QSOs have resulted from 1500 to 2100 when band is open. LX1SI Luxembourg (getting fairly regular, these days), F8TU and F8TY France, G6WT, G5OU, G8TH, G2IG, G6GO, G4PC, G4CY, G3QK being the best by far with S8 and over, not forgetting the mysterious OIX7 Helsinki, Finland, who was QSO'd by 6KW and 6DF recently. The whole of VK and ZS have been chasing that bird.

**Africa.**—These boys from the dark continent may be heard and worked often now with some f.b. signals coming through. SU1HF and SU1WS Egypt, VQ4ERR Kenya, VQ3TOM Tanganyika, ZE1JZ Southern Rhodesia, with ZS5DA, ZS6EG, ZS6JB, ZS4H, ZS6EB, ZS1W, ZS1CN, ZS6BV, ZS6EQ providing good QSOs from the south.

**Asia.**—These J, VS, VU, and XZ are easier to QSO than local VK6s these days. Two nice contacts were CR9AG Macaco (opposite Hong Kong) and HZ1AB Hedjaz.

**Oceania.**—Towards end of month the KH6, KA and ZL have been pouring in. KH6BI and KH6FC Hawaii, FK8VB New Caledonia, and J9LG Kwajalton providing the best QSOs.

**North America.**—Ws still pouring through in droves, although conditions haven't been up to scratch except between 1100 and 1300 daily.

**Central America.**—Few choice contacts in CO2JV Cuba, KZ5NA Canal Zone, and YMLB Nicaragua made earlier in month.

**South America.**—A surprise was in store for VK6 over Easter from this elusive Continent. Good Friday showed promise when YV1AN showed up. Saturday the band opened up with a wallup, HK3AO, HK3QS, HK3DW, YV1AN all being worked with S8-9 signals both ways. HC1FB was also worked on Easter Monday. W.A.C. in VK6 now has become quite regular.

**14 Mc. Phone.**—This band has provided the DX hound with plenty of entertainment this month, and this mainly is the reason why no notes are included in this issue.

**Europe.**—Has been wide open from midnight to 0300. PA0JQ and PA0FB Holland, OZ8SS Denmark, ON4US Belgium, F8GM and F8KI France, D4AKH and D4ATH U.S. Zone Germany, D2CI and D2CD British Zone Germany, I1SM Italy, HB9ET Switzerland, and G8WS, G2WW, G3AAK,

G6AG, G2PL, G3QK being the best of many English QSOs. From 1600 to 1800 occasionally has favoured "long way around" operation. Two good contacts were CT2WX Azores and W2MMO Portable D4 Marine, 800 miles S.W. to Azores.

**Africa.**—This Continent again coming through from 2300 onward, ZD6DT Nyassaland, ZE1JX Southern Rhodesia, and many ZSS.

**Asia.**—Very consistent these days from 1700 onward and getting to the stage when VU, C, J, VS, etc., are not considered as DX!

**Oceania.**—KH6, KG6 and ZL still being worked—KH6HO being the best QSO.

**North America.**—Countless Ws appearing, from 1500 to after midnight, daily from the N.E. VEs from Canada included 3AIU, 3HC, 3QL, 3VU, 4IF, 4RP, all being excellent QSOs.

**South America.**—No contacts made this month although some of these elusive birds were heard. HC3JW Ecuador put in an S8 signal.

A few notes from country fans to VK6KW, c/o P.O. Box N1002, supplying a little information as to their activities would be appreciated.

## IN REVIEW

The new "Eddystone" Amateur Bands Communications Receiver Model 640 has been designed in collaboration with several expert amateurs and initial tests convince our Principals that in the 640 is a set that will prove a real "winner" with the Hams. The receiver has been designed primarily for Amateur Communication purposes, and it is arranged to operate from a.c. mains or from a 6 volt battery, by the use of a separate vibrator unit.

It is a nine valve superhet., the valves having the following functions: EF39 r.f., 6K8GT freq. changer, EF39 1st i.f., EF39 2nd i.f., 6Q7GT det., a.v.c. and audio amp., 6V6GT output amplifier, 6X5GT rectifier, EB34 noise limiter, EF39 osc.

The aerial circuit is arranged to match into 400 ohm feeder line, but good results are obtained with aeriels, the impedance of which varies widely. The tuning is in three overlapping bands, which are selected by a low-loss, low-capacity switch. The ranges are: (1) 31 to 12.5 Mc., (2) 12.5 to 5 Mc., (3) 5 to 1.7 Mc. An electrical band-spread arrangement is used for this purpose. Fly-wheel control is utilised on the band-spread condenser drive, while the scale is clearly marked with all amateur bands, and is so arranged to enable accurate re-setting to a spot frequency.

A frequency of 1600 Kc. is utilised so that a really good image ratio is obtained, even at the highest frequency. The transformers are rigid-

ly constructed and permeability-tuned and have excellent frequency stability. The b.f.o. is constructed in a separate unit so that efficient screening is obtained. It is permeability-tuned and has a high degree of stability. Pitch is controlled by a variable condenser which is adjusted from the front panel. The xtal filter unit is the outcome of considerable development work. The xtal itself is vacuum mounted, ensuring a high degree of stability and outstandingly high Q. It is free from spurious responses, an adjacent channel attenuation in the order of 45 db being obtained. Phasing control and "in/out" switch, are brought out to the front panel. The a.v.c. system has been carefully designed, and may be switched in or out by a panel control. Sensitivity is better than 2 microvolts input, for 50 milliwatts output, at all frequencies. With xtal out, selectivity is 25 db down at 10 Kc. off resonance.

A particularly efficient series limiter arrangement is used, and is controlled by a switch operated from the front panel. The image ratio at 30 Mc. is 45 db down, at 20 Mc. 55 db down, 10 Mc. 60 db down, 5 Mc. 80 db down, 2.5 Mc. 90 db down, and at 1.8 Mc. is 100 db down. Audio frequency output of the receiver exceeds 3.5 watts into a 2.5 ohm output which is provided at rear of receiver for loud speaker use, and a higher resistance telephone output is available at a jack on the front panel. The speaker can be cut out when phones are plugged in. A socket is provided at the rear of receiver so that an external S meter unit can be connected when required. The scale of the meter is illuminated from the rear, by two 6 volt 1.8 watt, bayonet fitting lamps.

The weight is 38 lbs (unpacked) and dimensions are: overall width, 16½ inches; depth 10 inches, height 8½ inches. Power consumption, 60 watts.

In view of the prevalent difficulties with raw materials, special components, etc., we cannot forecast with accuracy, when the set will be on the production lines. Our Principals' target is to have supplies ready to ship by August and we hope you will wish them luck. It is hoped that the price will not exceed £65.

## WARNING TO PURCHASERS OF DISPOSALS EQUIPMENT

It has been reported that the 2½ inch Simpson Thermo-couple Ammeters, (calibrated 0-1.5 amp. r.f.), purchased by Victorian Division members, may be damaged if used on d.c. This is due to the unusual Thermo-couple design. If you desire to check your instruments at frequencies other than r.f., use 50 cycles per second a.c.

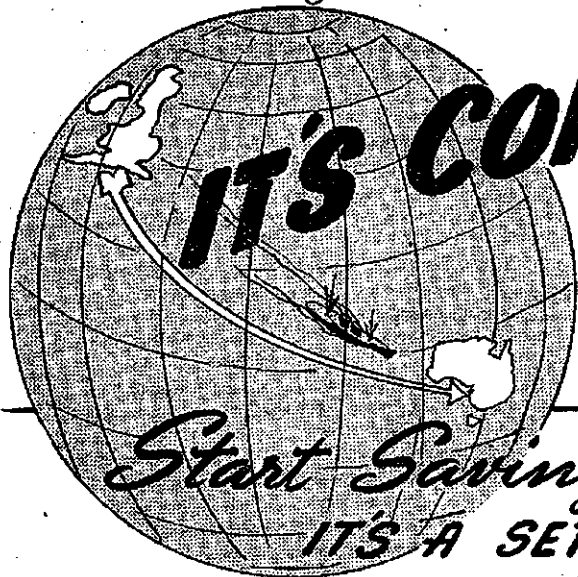

**IT'S COMING** —  
 THE *New*  
**EDDYSTONE**  
 AMATEUR BANDS COMMUNICATIONS  
 RECEIVER MODEL 640

*Start Saving Hams*  
**IT'S A SET YOU'LL WANT TO OWN**

**MAIN TECHNICAL FEATURES**

1. Receiver has been designed primarily for Amateur Communication purposes, tuning range from 31 Mc/s to 1.7 Mc/s.
2. Designed to operate from Standard AC Mains with Inputs of 110 volts 200/240 volts, 40/60 cycles as well as from a 6 volt battery by the use of a separate vibrator unit.
3. The receiver consists of 9 valves as under:

TYPE	FUNCTION
EF.39	R.F. Stage
6K8GT	Frequency Changer.
EF.39	1st I.F. Amplifier.
EF.39	2nd I.F. Amplifier
6Q7GT	Detector A.V.C. & Audio Amplifier.
6V6GT	Output Amplifier.
6X5GT	Rectifier.
EB.34	Noise Limiter.
EF.39	Beat Frequency Osc.

4. **INPUT IMPEDANCE**—400 ohms.
5. **TUNING RANGE.**
  - (1) 31 to 12.5 Mc/s.
  - (2) 12.5 to 5 Mc/s.
  - (3) 5 to 1.7 Mc/s.
6. **TUNING.** An electrical band-spread arrangement is used for this purpose. Fly-wheel control is utilised on the band-spread condenser drive. The scale is clearly marked with all amateur bands, and is so arranged to enable accurate re-setting to a spot frequency.
7. **I.F. FREQUENCY**—1600 Kc/s.
8. **CRYSTAL FILTER** is vacuum mounted to provide a high degree of stability. Phasing control and "in/out" switch are brought out to the front panel.
9. Sensitivity is better than 2 microvolts input, for 50 milliwatts output, at all frequencies.
10. **OUTPUT.** Audio frequency output exceeds 3.5 watts.
11. **"S" METER.** A socket is provided for an external "S" Meter.

★ **FOR FURTHER TECHNICAL DATA See Article on page 12**

Yes, YOU will want to own the 640 — because it's the BEST yet . . . a set that will provide more enjoyment and satisfaction than any communications receiver yet built. As yet, we don't know the cost of production, but it is estimated that the selling price should be in the vicinity of £65. Believe us it's worth saving for, and you have several months yet to tuck those shillings away—also, your distributor will be glad to arrange suitable terms. We'll advise you the minute this excellent set becomes available—in the meantime, hold on to your patience—AND—your cash.

**SHORTLY AVAILABLE  
 FROM YOUR DISTRIBUTOR**

- **VICTORIA:** J. H. MAGRATH & CO.,  
208 Little Lonsdale Street, Melbourne.
- **N.S.W.:** JOHN MARTIN PTY. LTD.,  
116-119 Clarence Street, Sydney
- **QUEENSLAND:** CHANDLERS PTY. LTD.,  
Cnr. Albert and Charlotte Sts., Brisbane.
- **WEST AUSTRALIA:** CARLYLE & CO.,  
Hay Street, Perth, and 397 Hannan Street,  
Kalgoorlie.
- **STH. AUSTRALIA:** GERARD & GOODMAN  
LTD., 192-196 Rundle Street, Adelaide.
- **TASMANIA:** W. & G. GENDERS PTY. LTD.,  
53 Cameron Street, Launceston.

Australian Factory Representatives:  
**KEITH HARRIS & CO. PTY. LTD.**  
 51 William St., Melb. Phone MB 2119

## FIFTY AND UP

Official Bulletin No. 82 from the A.R.R.L. Headquarters, Hartford, Conn., 27/3/47, to all Radio Amateurs:—

"The first 50 Mc. two-way contact between North and South America occurred on 23rd March at 2.50 p.m. E.S.T. when W4IUJ, of West Palm Beach, Florida, worked OA4AE, Lima, Peru, a distance of 3,000 miles. W4GJO of Orlando, Florida, also worked OA4AE shortly after. W4IUJ becomes eligible for the Milwaukee Radio Amateur Club's 50 Mc. Cup offered to the first amateur making two-way contact with another Continent on 50 Mc. from the U.S.A. mainland.

"Favorable propagation conditions on 24th March resulted in reception of 50 Mc. automatic transmissions from PA0UN by South African stations ZS1P, ZS1T, ZS1AX, and ZS1DJ over a 6,000 mile path. The greatest distance at which 50 Mc signals have ever been heard. Possibility of International DX over North South path is good through April.

"V.H.F. workers are urged to watch frequencies near 50 Mc. from mid-morning to mid-afternoon and report any DX heard or worked."

### NEW SOUTH WALES

Owing to the maximum useable frequencies being so high during the last few weeks, naturally the activity on 50-54 Mc. was most pronounced especially in Sydney and the Blue Mountain areas, where daily and nightly observations were diligently carried out, but unfortunately, to no avail, because not a sign of the elusive DX was heard; although a few "ghost" carriers were logged with all the characteristics of a long-distance signal.

However no identification was given, despite repeated requests that this necessary procedure should be carried out according to regulations, so possibly some interesting contacts were presumably lost owing to forgetfulness on the operators' part.

On the other hand these strange carriers might have been harmonics of some high powered commercial station on a lower frequency who sometimes delight in leaving carriers running for hours at a time, just to keep a channel open for checking purposes. Anyhow the fact that no DX was reported was due to no fault of the active stations in VK2 who keep a constant watch on 50-54 Mcs.

The good news from the other side of the world regarding record breaking contacts between U.S.A. and South America, and a Dutchman being heard in South Africa helped to redouble the VK2 stations' vigilance; so summing up the situation, we can safely say that the New South Wales

boys will be amongst the first when conditions permit the DX to break through.

The following stations are on regularly in Sydney suburban and mountain districts, and we give their call signs in order of frequency: VKs 2ZN, 2AGL, 2IA, 2LY, 2AHF, 2NO, 2JU, 2ABZ, 2EM, 2XV, 2ALO, 2AZ, 2AC, 2YQ, 2MQ, 2JG, 2BZ, 2LS, 2AEX, 2NP, 2LZ, 2FO, 2AFE, 2ABC, 2AGO, 2AFO, 2WJ, 2DF, 2LQ and 2ALP. Quite an imposing list you will agree and when the N.S.W. country members report on their activities and frequencies, and their call signs are added to the above, this State will perhaps have the honor of being the first to win the coveted W.A.S. trophy, because several VK2s only need VK6 to claim this award, which is quite a meritorious performance.

One is also impressed by the originality of the conversations that are carried out on the V.H.F. frequencies and it is a pleasure to listen to the interesting discussions on this and that, and the keen sense of humour that seems to be a feature amongst the VK2 stations.

Keen experimentation is another excellent phase of the activities, and the willingness to co-operate readily must serve as an example to the increasing number of listeners who derive so much pleasure by listening to the various contacts that are made. One cannot help thinking also of the progress that has been made in the design of the equipment. Although there are still a few stations in VK2 who are persevering with modulated oscillators and super-regen. receivers, the majority have crystal controlled transmitters and up-to-the-minute super-het. converters or some such, using the latest developments in V.H.F. tubes.

The quality of some stations is really excellent with VK2JU and VK2WJ among the top liners. 2ZN, 2NO, 2EM are also up among the best and as all these stations are crystal controlled with efficient plate modulation, this should prove to those who will persevere with the old style of mod. osc., with its bad frequency instability characteristic, that they are not in the race as the saying goes, and should definitely try their utmost to modernise their equipment. Fortunately those stations are in the minority and one by one they are "seeing the light," so we must be tolerant and lend the helping hand where necessary to make VK2 the first State with 100% crystal controlled transmitters and stable super-het. receivers.

This should not be such a difficult task because with the surplus equipment from the various Services at our disposal at quite a reasonable figure, the job is made so much the

easier and the techniques of building and testing 50 Mc. gear follow very closely the same routine as used on the lower frequencies.

Activity on 166 Mc. is quite high, there being some half dozen or so regulars going nightly. VK2AEE is using crystal control on this band and gets around quite nicely. VK2ABZ is another contemplating crystal and should be heard before long. VKs 2KI, 2AGL, 2YE, 2LZ, 2LY, 2AFO and 2WJ are heard most nights with reasonable signals at the writer's location.

There has also been some paper talk of operation on 1,400 Mc. but up to date no report has been received of any activity on this band. Speaking of reports we know very little so far of the work on V.H.F. being done by the N.S.W. country members and this includes the Newcastle gang which we understand are active but so far no worthwhile results have been made known. Therefore we would be very pleased to receive any information whatever, of your activities, experiments carried out, contacts, etc., and equipment in use, so that we can tell the rest of the world that the amateur in Australia is carrying out his part of the programme to the best of his ability.

In subsequent notes we propose to publish a full list of VK2 frequencies and station descriptions as they come to hand, really as a matter of interest and to tell the other fellow where we are and what we are using in the way of equipment.

The Council of the N.S.W. Division is endeavouring to organise an active V.H.F. section with a view to fostering interest among the VK2 members in frequencies above 28 Mcs. General opinion seems to be that it would be an excellent scheme and full co-operation seems assured. It was suggested that the V.H.F. Section hold regular monthly meetings at Science House, with its own administration responsible to the Divisional Council. This idea seems quite a sound one and should meet with general approval. Members will be advised through the usual channels:— "The Monthly Bulletin" and VK2WI on Sunday morning broadcasts at 11 a.m.

### VICTORIA

The V.H.F. Group meeting was held on Wednesday, 9th April, the following being present: VK3s TQ, MN, ACM, HK, AJH, BD, MJ, LR, XA, ARN, QO, ABA, NW, AHM, YJ, Messrs. Belcher, Gilbert and Gee Wah. The main item at the meeting was a very interesting lecture delivered by Dave Medley on V.H.F. receivers, and in particular the valves most suited for V.H.F. work.

On show were three receivers demonstrating the use of acorn tubes, button tubes and tubes of the EF50



and ECH35 construction. After this lecture, extracts of which will be published in "Amateur Radio," there should be no excuse for anyone to have a poor receiver, because it became apparent that a simple combination such as 6AK5 r.f., 6AG5 mixer, and 955 osc., represents just about the ultimate for 50-166 Mc.

A successful field day was held on the 23rd March. Portables out were 3HK and 3DH Mt. Dandenong region, 3PK Arthur's Seat, 3LR Mt. Macedon, 3ABA-YS near McVeighs, 3NW Mt. Buller, 3HZ at Warrigul could be regarded in this light, and 3BW was another distant station. 3WO was on Mt. Buninyong. Of the Melbourne stations 3WI was heard at good strength from the Wireless-Institute rooms using the final amplifier of 3NW. The longest contact was that between 3NW and 3PK, approximately 110 miles, but 3HZ of 3LR was a close second. Record for number of contacts made must surely go to 3HK who, with 3MJ and 3YJ as alternative operators, had two-way communication with 20 stations.

3QZ, at Chelsea, constructed a 50 Mc. rotary beam during the morning of the field day and made his first appearance on that band. With the beam only 7 feet high he contacted 3HK at Olinda and received report of Q5 S9, so up went the beam to 35 feet. The rig consists of a 6V6 xtal osc., 6A6 doub. doub., and 807 doub. to 807 final with 16.5 watts input. Antenna is a 4 element rotary with folded dipole driven element.

During the past month, activity on the 166 Mc. band in Melbourne has been showing signs of gradually increasing. In fact on some nights it would be quite possible to find two two-way contacts taking place at the one time. Considering the band is 4 megacycles wide, there is still plenty of room for those enthusiasts who find the experimental technique necessary for this V.H.F. band of practical interest. Small valves, capable of efficient operation on this band, appear to be readily available and as well as being suitable for receivers, can be used satisfactorily in transmitters, but even the old 56 can be used satisfactorily.

A number of stations at present on this band are using as the transmitting valve the 7193 (2C22), a triode with 3.3 watts plate dissipation, and in conjunction with small vertical beam aerials, obtain very satisfactory results. To date, propagation characteristics on this band are very reminiscent of the pre-war 56 Mc. band, and the general technique is also, in many ways, quite similar.

A general review of the latest activities of the various stations known to be on this band, is given below. 3EM, in McKinnon, is a newcomer to the band. He is using a 7193 as a transmitter, and a 955 as a super

# GLO-RAD

## OFFERS:—

Push/Pull Driver Transformer 6SN7 or 6A6 to 807's  
Modulator Output 50 Watts. PRICE 20/- Plus Sales Tax

## "GLORAD" 2006 SERIES TRANSMITTER COIL MOUNTS

2, 3 and 5 Contacts, Polystyrene and Micanol Bases.  
3 and 5 Contact Bars are non-reversible.

PRICES ON APPLICATION.

**GLORAD ENGINEERING SERVICES**  
186A Riversdale Road (Cr. Robinson Road)  
**HAWTHORN ————— VICTORIA**

Phones: Day—WA 3819. Night—WX 3440

regen. receiver. A 4 element beam, 18 feet high, is used for the transmitter and a co-axial dipole, 40 feet high, is used for the receiver. 3MB, in Hampton, has been constructing portable equipment, and intends making use of a 7193 in a transceiver. He has raised his beam from 18 to about 25 feet, and obtained one S point increase in his signal at 3ACM in Hartwell.

3MJ has reached this band, using an 11 tube superhet. receiver and a crystal controlled transmitter using an 832 in the output stage. At the time of writing he has worked two-way with 3NW and heard 3ACM, 3MB and 3ARK. 3NB has been using a "Niuutta" array consisting of two half-waves in phase and two reflectors one quarter wave behind, together with appropriate matching transformers. It appears to have reasonable forward gain and made considerable difference on reception of signals from the Brighton-Hampton area. Some preliminary work has been done on establishing crystal control at 3NB.

3NW has stabilised his transmitter with crystal control. Ken's signal is the first crystal controlled signal to appear on the band. He uses an 832 amplifier. 3OF has been conducting field tests with a portable transceiver and has been meeting with some success, and is able to communicate between Oakleigh and Hampton. 3TZ has been heard by 3NW, but largely works stations in the South. 3UJ has not been heard for a month, and not for want of listening either. 3XM has appeared on the band. He is using a 56 in a parallel lines oscillator, and a pre-war 56 Mc. J antenna.

As yet, he has been heard in a limited area.

3ACM is now on phone, having satisfied the authorities with his proficiency on the key—as stations on this band could testify. He has raised his six element beam to 22 feet and is trying to obtain results from a super regen. superhet. between contacts. 3ARK has appeared, using a super regen. receiver, and a transmitter with an 832 in the output. He tried out a ground plane antenna but found out, as others did who tried this aerial in Melbourne, that the dimensions used were incorrect. As far as is known, no station is using a ground plane antenna correctly designed.

It would be interesting to know who has a receiver for listening on 166 Mc. band. Possibly some good listening distances are being consistently covered. The best suburban effort to date appears to be a two-band contact between 3LS in North Essendon, on 50 Mc., and 3MB in Hampton, on the 166 Mc. band. 3LS is about 250 feet and 3MB about 50 feet above sea level, and distant approximately 15 miles. There is, however, no intervening hill higher than 50 feet anywhere along this path. 3MB has also worked crossband with 3YJ, the latter being on the 50 Mc. band.

## QUEENSLAND

Today's star artist (with apologies to the ABC) is of course VK4HR, who on top of working 104 countries post-war, has added further lustre to his call by the famous 50 Mc. contact with W7ACS (portable K6) on Monday, the 3rd of March, at 1213 hours.

Brisbane time. Our humble congrats Tibby. For the archives and for those who don't know, both W7ACS and 4HR have heard one-another but as yet an actual QSO has not eventuated. As yet—we said, that means at the time of writing!

The next item on the programme is an account of the recent 50 Mc. Field Day held by the local V.H.F. gang, on the 23rd March. 4ES (with 4RC) set up his rig on Mt. Cootha, a baby mountain near Brisbane, whilst 4XG took the advice of the

sage who said "go west, young man," and with the rig in the back of the car journeyed as far as the Marburg Range, some 40 miles from Brisbane. He stopped at Haigslea, just beyond Ipswich and from this rather atrocious location made contact with 4ES, 4HR (at his home QTH) and also with 4KB who, with 4RT as aide, was on top of Mt. Gravatt, also near the City. Reports varied from S8 to 8, and so as things augured well, Gordon (4XG) went on to Marburg where from the foot of the Range he received the locals at S8 to max. His signal was received by most of the locals at S6 to 8.

In all, a most successful day, and as line of sight frequently did not exist, it makes us feel that Toowoomba and Ipswich would be a cinch. A listen was kept for the V.H.F. gang in Bundaberg, but except that 4ES heard a weak signal for a couple of minutes, we did not achieve any results in that direction. Anyhow thanks fellows, and we hope you'll be with us again.

A very much improved signal on the band is that of 4TR, who is now operating on crystal. After a few bugs in the modulator have been cleared up, Dick's signal should be really tip-top. Fred Beech still tries valiantly to tame his converter, a job which has sorely tried his patience owing to a bout of the 'flu. We have it on good authority that any ordinary man would have been laid low, but not 4FB.

In the recent test with 4XG at Marburg, Arthur (4AW) received convincing proof that his beam was really pulling its weight as his signal was easily the best of the locals heard. We have it (reputedly from the horse's mouth) that he had to turn his house round to point his beam, but strongly feel inclined to put this down as a bit far-fetched.

4FB and 4ZU are both playing around with new receivers, the job in question being a certain fixed tune receiver used in aircraft. After minor alterations which included fitting conventional tuning to the oscillator and mixer, the line-up is 717A mixer, 717A h.f.o., 12SG7s 1st and 2nd i.f., 12SQ7 det. and 12A6 audio. The job seems to perform rather well and we feel sure that it is quite capable of dragging in any DX that happens to be about.

#### SOUTH AUSTRALIA

5KZ puts in an excellent signal on 166 Mc. using an RK34, and 5GF puts a nice signal across town with his single 7193. 5GB has been doing a spot of mobile with p.p. 7193s. He was perfectly readable from the foothills, approximately 8 miles—or perhaps a little further. A week later we had what we claim to be the shortest QSO on this band. My shack

to the kerb, about 30 feet and Q5 both ways! Our-skeds were unsuccessful on the run to Brighton although he copied my signal right to the Bay.

5NG has also put in some good portable work. He was QSOd on the move, between Kirkaldy and Grange, six miles from here. Incidentally, it is believed that 5NG and 5GF hold the State record for this band, 12 miles. The past week has seen 5QR, QRX, on 166 Mc. anyhow. 5RT built a beam in the hope of working the DX station and the latter forgot all about the sked!

## DIVISIONAL NOTES

### NEW SOUTH WALES

Secretary: Peter H. Adams, VK2JX  
Box 1734 G.P.O., Sydney.

Meeting Place: Science House, Gloucester and Essex Streets.

Meeting Night: Fourth Friday of each month.

The monthly general meeting was held on Friday, 28th March. The meeting was very well attended and members showed great interest in the Agenda items for the Federal Convention. Some 54 items were discussed and members were given the opportunity to direct Mr. Jim Corbin, the N.S.W. delegate, as to the handling of each item.

It was good to see Mr. Morrie Myers (2VN) back in VK2 again. Morrie has been overseas on behalf of his Company and has promised to tell us about his experiences at the next meeting.

The matter of the allocation and despatch of disposal crystals will be attended to within the next few days although some frequencies are over ordered and will require balloting for.

Don't forget the technical articles for "Amateur Radio." There is a prize of one guinea for the best article submitted each month. This offer holds good for six months so please go to it and help our magazine.

Welcome Bob Gordon, 2RH. A newcomer, but already well established on 14 Mc. with the DX. Has a nice 8 tube super and an 807 in the final.

— — — — 2DK is active on 28 Mc. — — — — 2AJW has been re-building and will be on 14 Mc. soon with c.w. and phone. That new rig looks good Ray. — — — — There was a minor hamfest recently. 2XX, 2YA, 2BJ gathered at 2SY's shack. Mrs. 2SY provided the tea; much talk. — — — — 2AT has new shack and three nice racks. Working on QSY by telephone dialling system.

The following are VK2 Zone Officers:— North Coast and Tablelands: VK2AFP, R. Gream; Newcastle and

# Low Drift Crystals

FOR  
**AMATEUR  
BANDS**

ACCURACY 0.02% of  
STATED FREQUENCY

3.5 M/C and 7 M/C

Unmounted . . . £2 0 0

Mounted . . . £2 10 0

12.5 and 14 M/C Fundamental Crystals, "Low Drift" Mounted only £5.

Spot Frequency Crystals  
Prices on Application

Regrinds . . . £1 0 0

THESE PRICES DO NOT  
INCLUDE SALES TAX.

**Maxwell Howden**  
VK3BQ

15 CLAREMONT CRES.,  
CANTERBURY, E.7.

# QUIET

PERMANENTLY

*Silent Spiral  
Connector ...*



NO SLIDE  
NO FRICTION  
NO NOISE

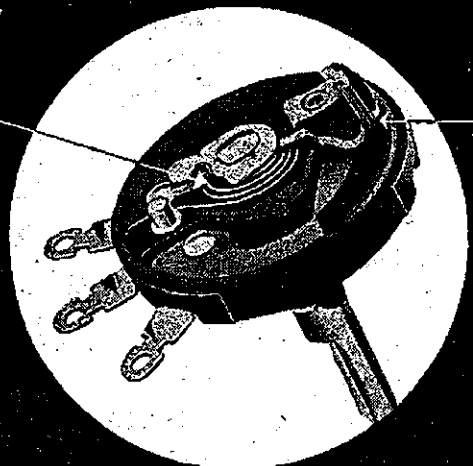

*5-Finger  
"Knee Action"  
Contact*



AMAZINGLY  
SMOOTH...  
PERMANENTLY  
QUIET

# IRC VOLUME CONTROLS

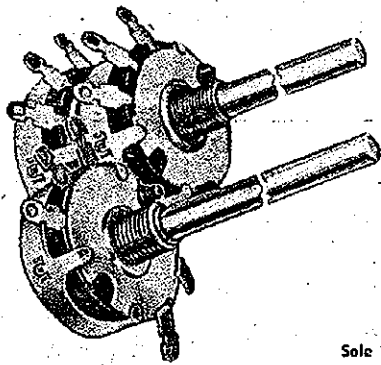

IRC HAS SPARED NO EXPENSE SO THAT  
YOU CAN BE SURE

Study the design of IRC Metallized Controls. Note in particular the precision construction of the 5-finger "Knee Action" Silent Element Contact and the new Silent Spiral Connector.

Each of these exclusive features means thousands of pounds in research by IRC engineers. Each means additional manufacturing expense—yet IRC Controls cost you no more than ordinary controls having neither of these noise-eliminating features.

It is "plus" values such as these that have made IRC resistance products famous the world over. By giving you the greatest value for your money, by doubly insuring you against customer complaints, we protect our reputation by helping you protect yours. That is good business for both of us.

Sole Agents for Australia:

**Wm. J. McLELLAN & CO.**  
BRADBURY HOUSE, 55 YORK ST., SYDNEY • PHONE BX2508

Districts: VK2XQ, R. J. Traill; Coalfields: VK2YL, H. Hawkins; Western: VK2QA, J. Russell; Southern: VK2OJ, N. Arnold. The V.H.F. Officer for New South Wales is VK2NP, C. Fryar.

## NORTH COAST AND TABLELAND ZONE

2LH is busy building an all band rig. Erected a 50 feet pole and a 14 Mc. electric-driven rotary is ready for mounting. Should be some good DX ahead. —...— 2ADE active on 14 and 28 Mc. and has 127 countries to his credit, 70 of same on 28 Mc. Chas still up to pre-war form. —...— 2NY working DX on 14 and 28 Mc. and recently added a c.r. modulation indicator to the works. —...— 2SH is heard frequently on 7 Mc. and am pleased to note that he hasn't given the air to c.w. since the phone ticket arrived. —...— 2AGM heard often with a nice signal; a rotary is under way and we hope it stands the gales. —...— 2CJ, Coff Harbour, on 7 Mc. phone at times, will be heard more often from his new home. —...— 2AFP is the Zone Officer, please send information to him at Casino.

## NEWCASTLE DISTRICT ZONE

When measured in terms of "ether busting," activity in this Zone is on the wane. 2BZ on 166 Mc. working 2VS, the latter temporarily in the District; good results have been obtained. —...— 2KQ is active on 50 Mc. and gets into Wyong. —...— 2ZC not very active but expects to work more in near future. —...— 2AHA gets his share of DX with a rotary. —...— 2FP still on 28 Mc. phone; one of our most consistent 28 Mc. boys. —...— 2WU on 14 Mc. with his old high class operating. Housing is problem and lives apart from gear (what a horrible thought). —...— 2AGY active on 14 and 7 Mc. with nice reports. —...— 2AGD active on 28 Mc. and new bottles ordered for his final. —...— No news of 2CS or 2KB, at least 2KB has been on 14 Mc. at times, but have doubts about Lionel ever getting on. —...— 2XQ QRL with new gear, had ideas of directive arrays for 28 and 14 Mc. but since 2EO won the DX Contest with a Zepp, will stick to the latter. Suggest forming a Zepp Club, entrance to those with 20 years uninterrupted operation with a Zepp—2XQ.

## COALFIELDS ZONE

2YO not heard of, how about some dope George. —...— 2XT mainly on 7 Mc., plenty of gear and big things should happen soon. —...— 2KZ is consistent on 28 Mc. phone and c.w. Max has been experimenting with 8JK half waves in phase with and without reflectors. —...— 2DG not much heard, probably is moving. —...— 2TY on 7 and 28 Mc. bands. How about some news from Lochinvar, Bob. —...— 2LB toying with a beam on 14 Mc. phone and c.w., a

# A.G. HEALING

LIMITED

MANUFACTURERS AND  
DISTRIBUTORS FOR . . . . .

Electrical and Testing Instruments for all purposes made to British Standard specifications. Each instrument is accurate, + or —, to 2 per cent., and parts are heavily plated to prevent corrosion even under tropical conditions. "Healing" Electrical Meters equal the best imported types and will give accurate service for long periods under the most exacting conditions.



No. 10A round production mounting Black Bakelite Case.

Type No. 30A 4" square semi-flush Black Bakelite Case.

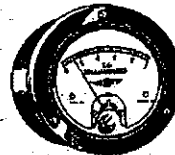

No. 20A 2½" round flush mounting Black Bakelite Case.

These, and all other Healing Radio Electrical Testing Units, are manufactured in our own factories and available from A. G. Healing Ltd.

OTHER INSTRUMENTS INCLUDE:

Oscillators — Multi-Testers — Signal Tracers, etc.



ALSO MANUFACTURERS AND DISTRIBUTORS FOR

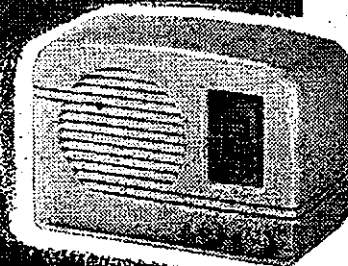

## Golden Voice RADIO

A. G. HEALING LTD., MELBOURNE, SYDNEY, ADELAIDE

new final is under way. — 2MK has deserted 14 for 7 and 3.5 Mc.; uses a conventional Zepp. — 2PZ is mainly on 7 Mc. on week-ends, accumulating a lot of disposal stuff. — 2ADT, the Zone's most active Ham, had 367 contacts in W phone test with a multiplier of 43. Contacts on 28, 27, 14 and 3.5 Mc., and is possibly the highest phone score. An 807 with 30-35 watts did the job. A QSL from AC4YN is a prized possession. — 2YL, with 4 half waves in phase on 14 Mc. has f.b. results. 386 contacts and a 33 multiplier was the result in c.w. W test. 102 countries up to date post-war.

### SOUTHERN ZONE

2VK should be on the air when this goes to print. Xmitter is 6F6 e.c.o. and Telefunken RL12P-35, antenna Zepp, receiver revamped Hallicrafters. Hugh not so pleased with the e.c.o., so some xtal grinding is ahead. — 2GG is re-building and making provision for phone. Rack and panel, built as an operating desk. — 2APW operating on 7 and 14 Mc. and is very pleased with new receiver. — 2EU building new home and will be more active in the new QTH. — 2OJ at last finished new 55 feet tower and driving gear under construction. Erection and lawn-mowing will be done in a short time (fingers crossed). — 2ANQ expects to be on shortly with p.p 809s. 807s to be used as modulators. More notes from other Southern Zone boys wanted. QTH: Box 54, Albury.

## VICTORIA

Secretary: A. B. D. Evans, VK3VQ,  
Box 2611 W G.P.O., Melbourne.

Meeting Night: First Wednesday of  
each month.

Meeting Place: Radio School, Mel-  
bourne Technical College.

### T.A.C. NOTES

The most outstanding event to report this month is the successful meeting held by V.H.F. Group on Wednesday evening (9th April). Dave Medley (VK3MJ) gave a most interesting lecture on V.H.F. Receiver Design, extracts from which will appear in "Amateur Radio." The animated discussion which followed proved that this subject was of the greatest interest to members of the Group. By the way one noteworthy outcome of this meeting was that Dave was persuaded to re-occupy the chair, on the condition that during his enforced absences members would take it in turn to act as chairman. This should prove a most interesting and instructive innovation.

The transmitter exhibited by Don Hope (VK3XO) represented the optimum design for such a unit, and we hope to persuade Don to publish final details and results in "Amateur Radio," in any case we must congratulate Don on the very excellent effort.

The new VK3WI transmitter has passed with honors the first series of tests, and by the time this screed is published should be operating in Band Edge Location Service. Eric Ferguson is about to commence the conversion of one of the G.O.9s for use in Communication Service.

The T.A.C. is awaiting with interest the formation of the new "Receiver Group." The formation meeting has been convened by George Neilson for 23rd inst. at Institute Rooms in Queen Street, and we hope the Group will prove of great interest and value to members. After all the two most important items in any Ham Shack are the Frequency Meter and Receiver.

As pointed out in previous notes, the T.A.C. is endeavouring to raise the technical standard of "Amateur Radio," while at the same time catering for the reader who is interested in construction. To this end we invite readers to submit constructive criticism of the items published. These criticisms will be published, together with author's reply and editorial note, where applicable. The whole object is to promote discussion section, for it is by such discussions that we are able to clarify points which may be open to misinterpretation, or need further amplification—your criticism (constructive) will be most helpful. What about it OMs.

The T.A.C. is seeking the co-operation of members who are able to devote a certain amount of time, in the home workshop, to the construction of class demonstration equipment—drawings and kits will be supplied.

### VICTORIAN DISPOSAL NEWS

Victorian Members are advised that the gear is now available off the latest "screed" and will be issued on every Tuesday night except the first Tuesday, as indicated on the "screed."

Do not make any telephone enquiries re the gear on the "screed" to any other number than FJ 6997 so as to help yourselves. This is important as the records are only kept at the rooms and it takes up the time of the various members of the Disposals Committee which could be used in furtherance of their business.

Do not forget that Loktal sockets and VCR139A sockets are available for those who drew those types of tubes.

## QUEENSLAND

Secretary (acting): F. Nolan, VK4  
JU, Box 638 J, G.P.O., Brisbane.

Meeting Place: State Service Building,  
Elizabeth Street, City.

Meeting Night: Last Friday in each  
month.

The Annual Meeting of the VK4 Division was held at the State Service Rooms on Friday, the 28th of March, and was well attended. Newly elected President, 4AW, was in the chair, and after opening the meeting extended a welcome to 4KO and 4WS, visitors from Ipswich. The minutes of the last Annual Meeting were read, followed by the Council Report and the Financial Statement.

4AW then moved a vote of thanks to 4RC, the retiring Treasurer and Asst. Acting Secretary. Bob has done a swell job and the vote was carried by acclamation. Discussion took place regarding the annual "Dinner" which we propose to hold in the Lady Bowen Hostel, Wickham Terrace, City. The tentative date fixed was the 18th April, which will enable delegate 4ES to return from the Convention.

Most of the positions of the new Executive were filled last month, the nominations being un-opposed, the exceptions being the posts of Vice-Presidents, Federal Councillor, and Publicity. These jobs were therefore balloted for and the following is the set-up for 1947-48:—President 4AW, Secretary 4RT, Treasurer 4ES, Vice-Presidents 4KH and 4KB, Federal Councillor 4KB, Country Representative 4SN, Traffic 4FJ, Publicity 4ZU, Librarian 4LT, QSL Manager 4EN, and V.H.F. Representative 4ZU.

Mr. Frank Nolan (4FN) outlined his progress with 4WI and the following is presented for general consumption. 4WI in future will operate simultaneously on 7100 and 14116 Kc. on Sunday mornings between 10 and 11 a.m., and as an added service will offer a Frequency Measurement Service on Tuesday nights between 8 and 9 p.m. The accuracy will be of a very high order and we feel sure that Frank will feel rewarded if the service is availed of. Pat Kelly at this stage of the meeting spoke in admiration of 4FN's effort, and in general, his enthusiasm for the job. We take it upon ourselves at this stage to say "thank-you" to Harry Angel (4HA) who filled the position when otherwise 4WI would not have been on the air.

Some fifty odd agenda items for the Convention were discussed and the views of the assembly made known to the Delegate. Discussion on 4HR's recent achievement on 50 Mc. took place and 4SN suggested that a special trophy or prize should be awarded in recognition of the feat.

did you hear him? —...— 6KW has a cat walk for his tower finished now to carry out repairs and alterations to his beam. While Ron is not a cat he reckons he is learning.

6TX was overhead ordering some chassis over the phone the other day. Jack is daily growing more Ham minded again and when he is not fishing off Mosman Bay he is listening. —...— 6AH was QSO'd by 6KW a couple of weeks ago. Stan tells us that 6MH (his XYL) is threatening activity too, but she is a bit mike shy so will be on c.w. for a while anyway. —...— 6MU is back again on the air from Merredin after letting all the big ones get away at Rott-nest. We think Mal is better on the end of a microphone than a fishing line. —...— 6KE was heard on phone the other night and quite nice quality too. What about a rest from it Keith on third Monday of the month?

## TASMANIA

Secretary: J. Brown, VK7BJ  
12 Thirza Street, New Town.  
Phone W 1328.

Meeting Place: Photographic Society's Rooms, 163 Liverpool Street, Hobart.

Meeting Night: First Wednesday of each month.

The Council meeting for March was conducted at our President, L. Jensen's residence, 313 Park St., New

Town, on the evening of Friday 21st, with 7LJ in chair, and others present were 7BJ, 7CT, 7CW, 7RF and 7PA. Apology from 7CJ. Minutes of previous meeting were read and confirmed. Correspondence and traffic network communications read and received, news of removal of 30 minute QSO limit was received with pleasure, and hopes are high for further relaxations. A quantity of inter-divisional correspondence was attended to. One membership application was received from J. T. Wilson (7JT) and passed on for general meeting's confirmation.

At the general business the Convention Agenda was the main item for discussion and occupied the remainder of the evening as, by the time Mrs. Jensen's supper could be done justice to, it was 2100 hours, so after expressing appreciation all were satisfied to be on their way leaving 7LJ to his weekly traffic skeds.

General Meeting, 2/4/47, present were 7LJ in chair, 7BJ, 7CJ, 7OM, 7AL, 7CL, 7DW, 7YY, 7LE, 7GR, 7MY, 7XA, 7TR, 7RF, 7CT, Messrs. Koglin, Durkin, Allenby, Moore, Harrix, Crosswell, Fulton, Brown and Cruise. Apologies from 7PA and 7RY.

Minutes of previous meeting were read and confirmed. Correspondence from Federal Executive on use of high power components, also re Ocean Currents "Raft" Expedition (can

think of better places to drift), and from N.S.W. Division re Technical Publications. New Member (J. T. Wilson) was unanimously elected to full country membership, welcome OM.

C. Oldham, "chief organiser," in the Food for Britain drive, reported progress. He has contacted VK7CM, now in England, and has received a reply in which Charlie says he is only too willing to represent us over there if needed. The fund here is mounting and this meeting added a further £5/10/- to it.

Another Field Day was concluded on 16th March, and from general opinion it was the best yet. As proof of this, yet another day is to be devoted to conducting the fourth, and this will possibly be the last, outing before the winter. Sunday, 20th April, has been named and all previous conditions will again apply, 10 a.m. to 1 p.m. on 3.5 Mc. band within 15 miles radius of G.P.O. with 7LJ doing the honor of transmitter hiding—don't make it too hard Lou and keep off the bush tracks!

The Convention Agenda occupied the balance of the night, thus no lecture was given and next meeting will be devoted to our delegate's report and has been reserved for same.

7LL suggested that an auction of Ham gear might be considered at a future meeting—this should make a good variation for a winter's night.

# RED LINE TRANSFORMERS & CHOKES

For the **F.F.R.** Amplifier **Now Available**

Type No. AR2

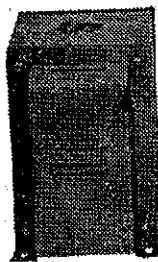

Type No. No. 5176



Type No. 50825



Type No. 102512



Type No. A.W.5

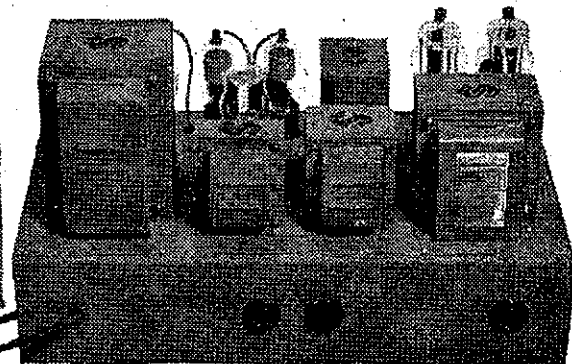

Pamphlet describing design and construction of the Full Frequency Range Amplifier available from:

## SWALES & SWANN

Technical Service, A. T. SWALES, Cent. 4773  
Wholesale and Manufacturers: 2 Coates Lane, Melbourne.

Trade Sales: ALLEN SWANN  
MU 6895 (3 Lines)  
157 Elizabeth St., Melb.

As there is no separate report of the last Field Day here is an outline of the day's activities which, as previously stated, was a great success. The start was at 10 a.m. on Sunday, 16th March, from Customs House, Wharf, where participants received sealed instructions and moved off for the first bearings.

7AL, having selected South Arm, situated as it is on a Peninsula approached from the eastern side of the Derwent, he set out, none too early, to reach the rendezvous and instal the gear. Yes! that would happen. Some river traffic demanded the opening of the bridge section just at that time and that was enough for a delay which was blamed for being just three minutes late getting on.

The first signal came to those listening from away down the Harbour (or may be the Hills in the opposite direction) accepting "down the Harbour" as O.K. Then which side? Over the bridge or not? Fortunately most decided to risk a crossing, two didn't and one of these finally spent the day at Brown's River—quite a nice beach of course—but about three miles or more by water and much too far to swim, and some 20 odd miles by road from where the directions,

when opened, said. The party consisted of 7XA, 7JH and family, of course time beat them.

7CW and party almost shared the same fate, being well nigh the same destination when he decided to turn back and make a dash for it having also realised that the signals had been playing tricks, not having shown a swing away until almost directly opposite the location, he beat the time by 15 seconds (officially) although rumour has it he was so roundly cheered and kept so pre-occupied that time slipped by—not suggesting that they did it on purpose Cros! Official time is taken from the handing in of the sealed directions unopened.

Here is the official list of those who finished with time of finishing and in the name of person in charge of each car:—7LJ (1st) 1145 (1½ hours), 7YY (2nd) 1155, 7BJ (3rd) 1205, Watson 1214, 7LL 1214½, 7NL 1217, 7CT 1222, 7OM 1223, Fulton 1244, 7CW 1259½, 1300 hours being limit, O. L. Brown arrived 1305 after opening his envelope. After a well enjoyed lunch the afternoon was spent at cricket for the lads and a chinwag for the lassies and both played their part well.

Some unorthodox practices were indulged in by the cricket group, sides were taken and additional players were enlisted from the locals, in fact if rumour can be believed, one side had reserves waiting just in case. What actually constituted a side was not revealed but a great afternoon's cricket was the outcome and all enjoyed themselves, the weather again was perfect although earlier it caused some doubt.

Minor "casualties" were reported, owing apparently to road conditions, and constituted a broken spring or two, a cracked chassis and it seems one car, that of 7YY, which had designs on going back to the Arm, having swung around in its own length and faced about. No doubt it had been so shaken up Bill that it lost its sense of direction, no car would refuse to go home! Fortunately no physical harm is reported so all is well that ends well. See you at next Field Day—maybe!

The first 7 Mc. ragchew took place on Friday, 28th March, with 7AB, 7CW, 7LE, 7MY and 7XL. 7LJ was also a tryer, more are asked to keep these evenings in mind, 8 p.m., 2nd and 4th Fridays in each month.

**A  
B  
A  
C**

**AUSTRALIA'S  
BEST  
AMPLIFIER  
COMPONENTS**

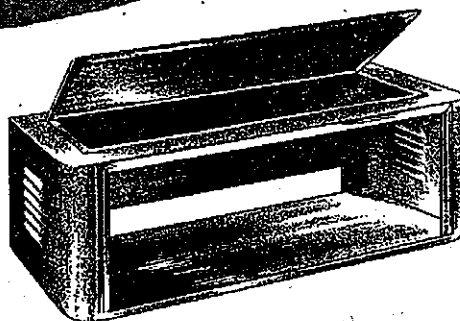

**ABAC**  
**Standard  
Receiver**

Or Instrument  
Case. Takes 19 x  
8½ panel with  
clear panel space  
17½ x 7½. Depth  
of case 11 inches.

MANUFACTURED BY

**TRIMAX TRANSFORMERS**

29-35 FLEMINGTON ROAD  
NTH. MELBOURNE, VIC.  
(Division of Cliff & Bunting  
Pty. Ltd)

# LOW IMPEDANCE HEADPHONES

By J. BROWN, VK7BJ\*

There are a great number of good headphones obtainable cheaply these days, the only catch being that they are of low impedance. This makes them more reliable, but they do not work too well when just connected in the plate circuit of a valve. One way to use them is to buy the associated step down transformer, but this does not seem to appeal to Hams as a whole, although it is an excellent scheme; perhaps they object to the extra bulk and weight.

Another system which, while quite common, may not be known to Hams generally, is use of a "Cathode Follower." This is a valve with the load entirely in the cathode circuit, giving a high degree of inverse feed-back. The net result is that although the valve will not amplify the input voltage, it provides a good match for the low impedance phones.

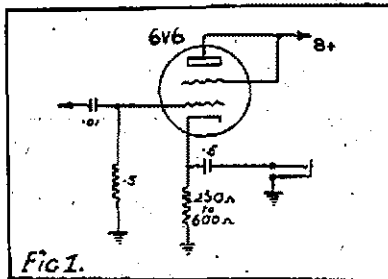

The cathode follower with low impedance phones will give results equivalent to a standard triode amplifier with high impedance phones or low impedance phones with a transformer for matching. The recommended circuit is as shown in Figure 1; note that there is no cathode by-pass condenser. For headphone use only, the higher values of cathode resistor are preferable as they reduce the standing plate current.

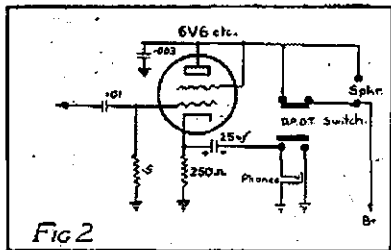

The circuit can be expanded to switch from a loudspeaker in the plate circuit to headphones in the cathode circuit as shown in Figure

\*12 Thirza Street, New Town, Tas.

2. This circuit can be used with high impedance phones but the level in them will be lower, but it makes a convenient answer to the old problem of switching from speaker to phones as the speaker may be disconnected altogether when using phones, if desired.

## RADIOTRON 6AU6

R.F. AMPLIFIER PENTODE WITH SHARP CUT-OFF.

MINIATURE TYPE (Tentative Data)

Radiotron 6AU6 is a miniature R.F. triple-grid valve with a sharp cut-off characteristic, low grid-plate capacitance, and high transconductance. The low value of grid-plate capacitance minimises regenerative effects, while the high transconductance makes possible a high signal-to-noise ratio. Because of its high transconductance and sharp cut-off, the 6AU6 is particularly useful as a limiter valve in F.M. receivers.

### GENERAL DATA

#### Electrical

Heater, for Unipotential Cathode:  
Voltage (a.c. or d.c.) ..... 6.3 volts  
Current ..... 0.3 amp.  
Direct Interelectrode Capacitance:  
Grid No. 1 to Plate 0.0035 mmfd.  
Input C ..... 5.5 mmfd.  
Output C ..... 5.0 mmfd.

#### Mechanical

Mounting Position ..... Any  
Maximum Overall Length ..... 2-1/8"  
Maximum Seated Length ..... 1-7/8"  
Length from Base Seat to Bulb Top (excluding tip) ..... 1 1/2" plus or minus 3/32"  
Maximum Diameter ..... 3/4"  
Bulb ..... T-5-1/2  
Base ..... Miniature Button 7-Pin  
Basing Designation ..... 7BK  
Pin 1—Grid No. 1 (control grid).  
Pin 2—Grid No. 3 (suppressor).  
Internal Shield.  
Pin 3—Heater.  
Pin 4—Heater.  
Pin 5—Plate.  
Pin 6—Grid No. 2 (screen).  
Pin 7—Cathode.

### AMPLIFIER

#### Maximum Ratings, Design-Centre Values

Plate Voltage ..... 300 max. volts  
Grid No. 2 (Screen) Voltage ..... 150 max. volts  
Grid No. 2 Supply Voltage ..... 300 max. volts  
Plate Dissipation ..... 3 max. watts  
Grid No. 2 Dissipation ..... 0.65 max. watt  
Grid No. 1 (Control Grid) Voltage:  
Negative Bias ..... 50 max. volts  
Positive Bias ..... 0 max. volts  
Peak Heater-Cathode Voltage:  
Heater negative with respect to cathode ..... 90 max. volts

Heater positive with respect to cathode ..... 90 max. volts  
Typical Operation and Characteristics Class A1 Amplifier

Plate Voltage	100	250	250	volts
Grid No. 3 (Suppressor)	Connected to cathode at socket			
Grid No. 2 Voltage	100	125	150	volts
Grid No. 1 Voltage	-1	-1	-1	volt
Plate Resistance (Approx.)	0.5	1.5	1.0	megohms
Transconductance	3900	4450	5200	micromhos
Grid No. 1 Bias for plate current of 10 microamperes	-4.2	-5.2	-6.2	volts
Plate Current	5.2	7.6	10.8	Ma.
Grid No. 2 Current	2.0	3.0	4.3	Ma.

### CORRESPONDENCE

539 Marion Road,  
Sth. Plympton, S.A.

Editor, "A.R.,"

During the past few months I have received QSL cards from many overseas amateurs (in reply to SWL reports) and remarks on many of the cards make it apparent that VKs are notorious for their failure to QSL stations they have worked. To quote a couple—

From GW5YE, 80 Penrhos Road, Bangor, North Wales, "How about persuading some of the VK transmitters to QSL OM? Have not received a single card back from them;" and from VE3BG, 192 Victoria Ave., Longueuil, P.Q., Canada, "Have had many VK contacts but no cards."

It is rather a poor show when overseas stations have to rely on SWL cards as proof that they have been heard in VK.

Suggest that you make some mention of this matter in "A.R." Enjoy the Mag. very much and look forward to it every month. Am newly appointed secretary of the S.A. Australian DX Radio Club and editor of the amateur section in the Club Mag. "DXSA." Hope to have VK5 call one of these days. Cheerio, es 73,

A. W. WRIGHT.

## FOR SALE, EXCHANGE, WANTED

9d. per line, minimum 2/-

FOR SALE—Bendix TA301B xmtr. 2500-Kc. to 15000 Kc. h.f., 300 to 600 Kc. l.f., xtal or m.o., uses 802-807-828s parallel, phone or c.w., price £30. Also VT30, 250 watt xmtr. triodes in case lots of three, price £3 per case. W. L. Brook, VK2ACT, "Valdemar," Dubbo.





## Why 'drift about' looking for **RADIO PARTS**



Maybe, there'll come a time when you'll be needing urgent replacements or a special addition to that transmitting unit or receiving set. It's then that you remember

# LAWRENCE & HANSON FOR **RADIO PARTS**

For many years L. & H. have been the regular radio suppliers to hundreds of amateur radio enthusiasts all over Australia.

The experienced 'ham' knows that the L. & H. components are the most efficient, the most reliable AND THE MOST COMPREHENSIVE RANGE OF RADIO PARTS PROCURABLE ANYWHERE.

If L. & H. can't supply those hard-to-get components, it is because they are simply NOT procurable. L. & H. components are guaranteed for years of quality service.

### CHECK THIS LIST OF PARTS RIGHT NOW !

MICROPHONES  
COILS  
BATTERIES  
METERS

SWITCHES  
VALVES  
VIBRATORS  
TRANSFORMERS

CHOKES  
CHASSES  
CONDENSERS  
SPEAKERS

RESISTORS  
LINEFILTERS  
Etc., Etc.

TECHNICAL ADVICE GIVEN ON REQUEST.

Obtain latest lists and prices from your radio house.

★ ★ **LAWRENCE & HANSON** ★ ★  
**ELECTRICAL PTY. LTD.**

33 YORK STREET, SYDNEY  
120 COLLINS STREET, HOBART  
87 ELIZABETH STREET, BRISBANE

172 WILLIAM STREET, MELBOURNE  
60 WAYMOUTH STREET, ADELAIDE  
20 PATERSON STREET, LAUNCESTON

*Are You Looking for*  
**SELECTIVITY?**  
*Then Try the New*  
**"AEGIS" HI-CORE I.F. TRANSFORMERS**

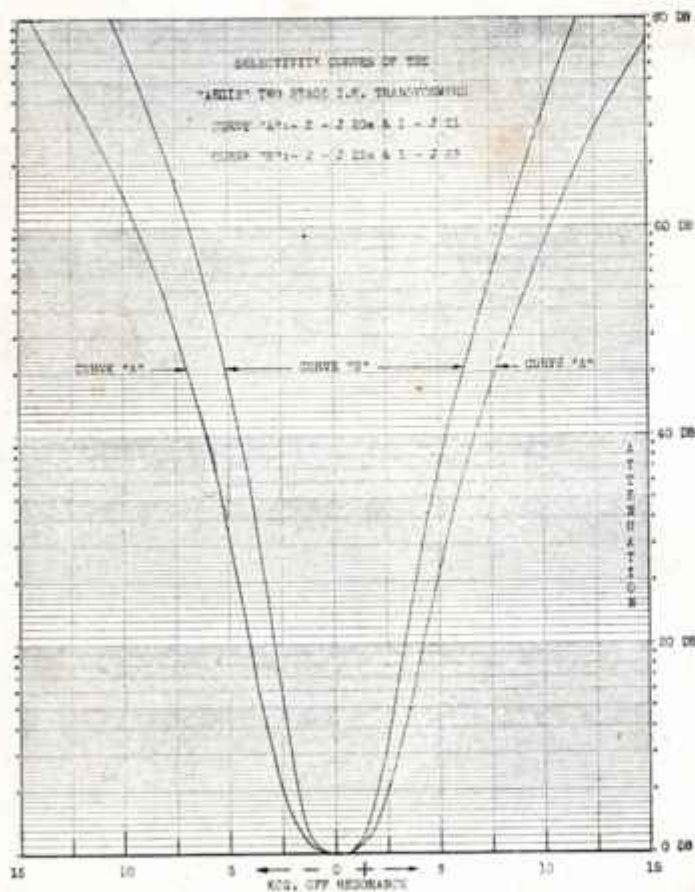

Scientifically Designed  
 Expressly for the  
 Two-Stage I.F. Channel

**INCORPORATING  
 THESE FEATURES**

- 1.** Maximum Stability
- 2.** Excellent Selectivity, particularly types J22/J23.
- 3.** Effects of Tube Loading reduced to a minimum.
- 4.** "Miller Effect" Detuning eliminated.

Medium Selectivity	
Type J20 Interstage	Price 13/9 ea.
Type J21 Diode	Price 13/9 ea.
Maximum Selectivity	
Type J22 Interstage	Price 15/- ea.
Type J23 Diode	Price 15/- ea.

NEW AEGIS D/W COIL ASSEMBLY  
 Type K15 and K25.

Specially designed for the new  
**6.S.A.7 SINGLE-ENDED TUBE**

No extra for this advanced feature!  
 FROM ALL DISTRIBUTORS OF . . .

**AEGIS MANUFACTURING CO. PTY. LTD.**  
 208 LITTLE LONSDALE ST., MELBOURNE

# AMATEUR RADIO

JUNE  
1947

JOURNAL OF THE WIRELESS INSTITUTE OF AUSTRALIA

## An indispensable instrument for the experimenter

To the experimenter the Philips "Philoscope"  
(A.C. Bridge) Type TA 160 offers seven  
major features.

- 1 The accuracy is unimpaired by mains voltage fluctuation.
- 2 A calibration system has been incorporated enabling rapid checking of the apparatus at any instant.
- 3 The highly sensitive magic eye indicator facilitates precise balancing of the bridge circuit.
- 4 The sensitivity of the indicator is variable. This is very helpful when measuring components of an unknown value.
- 5 It is not possible to damage the instrument by overloading the indicator or by faulty connections.
- 6 The maximum voltage applied to test components is 3V., or in the case of low resistances, the maximum current is 500mA.
- 7 The apparatus can be operated from 220V., 240V., 260V., 40/50 cycles mains supply.

We will be pleased to supply you with further details on request

# PHILIPS

## PHILOSCOPE TYPE T.A.160

PHILIPS ELECTRICAL INDUSTRIES OF AUSTRALIA PTY. LTD.  
SYDNEY : MELBOURNE : ADELAIDE : PERTH : BRISBANE



FOR THE EXPERIMENTER & RADIO ENTHUSIAST

Registered at G.P.O., Melbourne, for transmission by post as a periodical.

6d.

*On the beam...*  
*with KINGSLEY*  
*radio equipment*

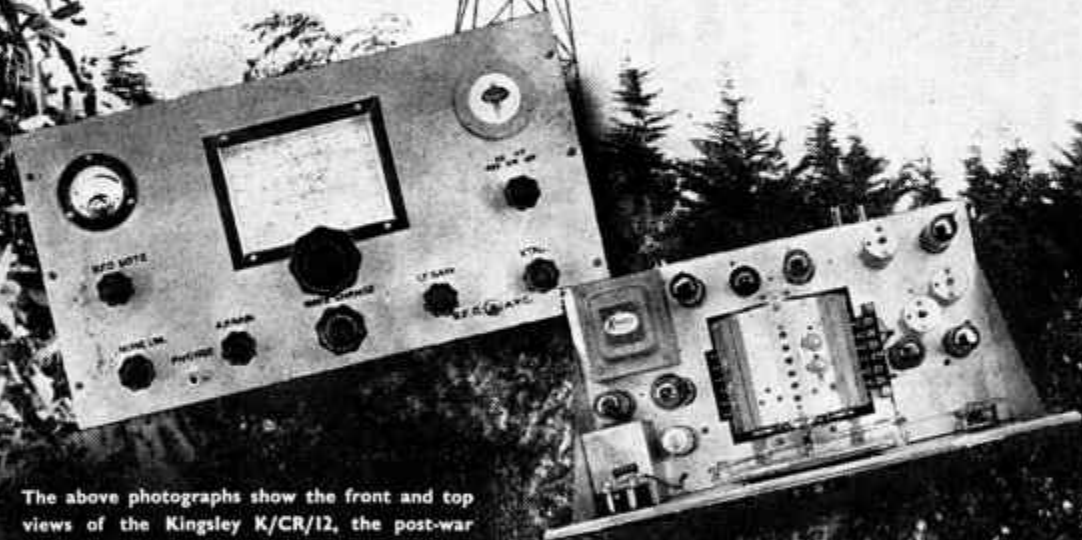

The above photographs show the front and top views of the Kingsley K/CR/12, the post-war brother to the K/CR/11 (AR7). Model K/CR/12 is a Ferrotuned turret band-change unit, and is an advanced forward step. You will fill your log quicker with the aid of Kingsley Equipment.

KP7



# KINGSLEY RADIO

KINGSLEY RADIO PTY. LTD.

380 St. Kilda Road, Melbourne, Victoria . Phones: MX 1159, MX 3653

# AMATEUR RADIO

Published by The Wireless Institute of Australia,  
Law Court Chambers, 191 Queen Street,  
Melbourne, C.1

**Editor:**

T. D. HOGAN, VK3HX.  
Telephone: UM 1732.

**Technical Editor:**

J. K. RIDGWAY, VK3CR.

**Notes Editor:**

R. W. HIGGINBOTHAM, VK3RN.

**Distribution:**

H. N. STEVENS, VK3JO.

**Business Manager:**

J. G. MARSLAND, VK3NY.

**Advertising Representative:**

W. J. LEWIS,  
20 Queen Street, Melbourne, C.1.  
Telephone: MU 5154.

**Printers:**

H. HEARNE & CO. PTY. LTD.  
285 Latrobe Street, Melbourne.

MSS. and Magazine Correspondence should be forwarded to the Editor, "Amateur Radio," Box 2611W, G.P.O., Melbourne, on or before the 15th of each month.

Subscription rate is 6/- per annum, in advance (post. paid).

— IN THIS ISSUE —

V.H.F. Receiver Design . . . . .	3
Clearing the Ether . . . . .	5
Such Nice People . . . . .	8
Federal Notes . . . . .	9
Q.S.L. Bureau . . . . .	11
Month's D.X. . . . .	12
Correspondence . . . . .	12
Divisional Notes . . . . .	15
In Review . . . . .	24

## EDITORIAL



The International Telecommunication Conference, the first since that held at Cairo in 1938, is, as we write, in session at Atlantic City, U.S.A.

What this Conference means to Radio Amateurs throughout the world is something that is well known to all who read this journal, we need not explain its significance here.

It is, however, of interest to note that all of the major powers represented at this present Conference have expended more time and thought on preparations for the great event than has been the case prior to any of the four previous Conferences. That such intensive preparations should be necessary is indicative of two things, that the advancements in the art and science of radio communication in the last two decades have been many, and that the claims now made on spectrum space by various interested parties have snowballed to the point where long deliberations by large staffs of experts have become essential.

Possibly this state of affairs lies in some manner behind the spate of idle and utterly nonsensical rumours which have been going the rounds in recent months; we even heard one to the effect that U.N.O. proposed to take over all our bands for broadcasting! It seems a great pity that there are among us some who have so little to occupy their time that they have to sit down and while away the hours in concocting that sort of furphy.

In actual fact the proposals of the major powers, insofar as they

were revealed at the preliminary Conference at Moscow last year, look reasonably hopeful. The U.S.A. proposals were, as usual, the most liberal, envisaging the retention by Amateurs of all the existing bands with the exception of the 160 metre band, but in its stead a new band at 21 Mcs. The proposals revealed by Great Britain, France and the U.S.S.R. were, surprisingly enough for the latter two, along similar lines. The exceptions were the proposed invasion of the 7 and 14 Mc. bands by B.C. stations, the elimination of the 3.5 Mc. band by the Russians, and the failure of Great Britain to include a band at 21 Mc.

We have been advised by the I.A.R.U. that the British proposals have since been modified to include a small band near 21 Mc., but on the other hand drastically cutting the other bands to 3.5-3.6 Mc., 7-7.2 Mc., the 14 Mc. band as is, and 28-29.7 Mc. The British idea now is that as sharing of bands between Amateurs and B.C. services is unsatisfactory to both, the B.C. boys should have it all their way. What manner of logic that is, particularly in view of the war record of countless British and Dominion Hams, we do not profess to know.

We can only trust to the undoubted ability of our representatives, the I.A.R.U. delegation, and hope that the more enlightened view of the U.S.A. authorities will prevail, which we believe, if there be still such a thing in this shattered world as justice, it surely must.

A.H.C.

# Radio Enthusiasts

## Watch for Bargains at **HOME CRAFTS**

You can get **IMMEDIATE DELIVERY** of the following **STAR BARGAINS!**

- ☆ **PROFESSIONAL TYPE CRYSTALS.** For 3.5 megacycle band, **£2/2/-**
- ☆ **IMPORTED BRADLEY POTENTIOMETERS,** 10,000, 20,000 and 30,000 Ohms **1/11**
- ☆ **ELECTRIC SOLDERING IRONS.** Radio Serviceman's type **19/11**
- ☆ **807 BEAM PENTODE VALVES** **16/6**
- ☆ **SILVER MICA .0001 CONDENSERS** **4/- per dozen**
- ☆ **MAGNETIC PICK-UPS** **24/11**
- ☆ **FOUR BANK WAVE CHANGE SWITCHES** **3/11**

### ● **MULTI METERS**

With 10 ranges.  
Shop soiled only.  
Almost half price. Only

**£5:19:6**

Every Amateur can quickly instal one of these Brand New Inter-communication

### **TELEPHONES**

These sets are ready for immediate use. Two-way communication can be effected between your home and workshop or garage, etc. Of special interest to country enthusiasts is the range—homesteads can be linked-up effectively to 10 miles.

Write for full details of this exceptional bargain. Mail orders accepted.

**OUTSTANDING VALUE at £2/2/- Ea.**

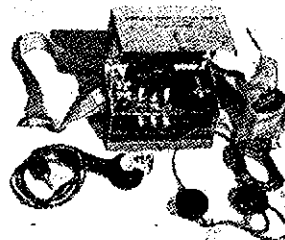

**CONNECTING WIRE** available at special prices. Write for leaflet.

*Homecrafts* **PTY. LTD.** **THE RADIO SPECIALISTS** Central 4311



Head Office: **MELBOURNE**, 290 Lonsdale Street, and at 211 Swanston Street, Melbourne.  
139 Moorabool Street, Geelong. 307 Sturt Street, Ballarat. 100 Clarence Street,  
**SYDNEY**. 26 Hunter Street, Newcastle. Hobart, Launceston, and Burnie, **TASMANIA**.

# V.H.F. RECEIVER DESIGN

By D. J. MEDLEY,\* VK3MJ

This paper is more or less a verbatim report of lecture delivered by VK3MJ at the April meeting of the V.H.F. Group (Victorian Division).

Any superheterodyne receiving system can be divided up into a number of major sections as follows:

- Audio.
- Intermediate Frequency Amplifier, Second Detector, Noise Limiter, b.f.o., a.v.c.
- Converter or mixer and local oscillator.
- Input circuit, including aerial coupling circuit and r.f. amplifiers.

Treating these in order it is not considered that any remarks need be passed on audio systems and second detector circuits as these are largely a matter of personal preference, and a large number of different circuits are capable of excellent and satisfactory results. Similarly circuits for b.f.o.'s, a.v.c., "S" meters, etc., are hardly within the scope of our discussion. However there is one circuit which is associated usually with the second detector and audio system which does bear vitally on V.H.F. work and I refer to the noise limiter. As is well known, there are many and varied types of noise limiter, some very complicated like the Lamb i.f. type and others very simple. I do not want to spend much time on this subject but I would like to commend to your attention a circuit which I think can be ascribed to the Hammarlund Co. It takes the form of a series diode limiter (see Figure 1), but it differs from the usual type in that a.v.c. is involved so that the limiter adjusts itself automatically to the level of the signal. For absolute simplicity it is the most satisfactory circuit I have yet struck, although results show that its effectiveness varies with the i.f. gain of the receiver. The higher

the gain, the greater the suppression. On an A.M.R. 200 receiver the results are amazing. Details of other types of silencers can be got from any hand-book.

## I.F. AMPLIFIER

Next we come to the i.f. amplifier. Ideally this should provide the majority of the gain and nearly all the required selectivity and image ratio. The three factors don't go hand in hand and some compromise has to be arrived at. When designing an i.f. amplifier the first point to be decided on is the i.f. frequency. Actually the choice of this is not as wide as may be supposed as there are various specific channels set aside for this purpose, and kept clear of interference, theoretically at any rate.

The frequencies are 176 Kc., 455 Kc., 1900 Kc., 7.5 Mc., 10.7 Mc. and 30 Mc. 75 Mc. is also regarded as a standard and 10.7 Mc. is the recommended standard for V.H.F. receivers. As far as we are concerned our choice would be between 455 Kc., 1.9 Mc. and 10.7 Mc., and the following factors should be taken into account:—

- Selectivity; the higher the i.f. the lower the selectivity.
- Gain; the higher the i.f. the lower the gain.
- Image ratio; the higher the i.f. the better the image ratio.
- Oscillator pulling; the higher the i.f. the less the pulling.

Taking a compromise I suggest the following i.f.'s. could be selected:—

For frequencies up to 14 Mc.—455 Kc.

For frequencies between 14 and 60 Mc.—1900 Kc.

For frequencies between 60 and 200 Mc.—10.7 Mc.

**Tubes.**—Having decided the frequency, the next consideration is the tubes. In general, high gain tubes are desirable because by their use fewer stages are needed, but we must consider selectivity. The more stages the greater the selectivity. Therefore if we require reasonable selectivity and the minimum trouble from instability, it is suggested that for all the three i.f. frequencies specified, low gain tubes such as 6U7, 6K7 and 6SK7 be used with the appropriate number of stages, viz.:—

455 Kc.—one or two stages.

1900 Kc.—two stages.

10.7 Mc.—three stages.

The use of 6AC7, EF50 type of tubes is not recommended as it is quite difficult to get high gain consistent with good stability.

The design of crystal filters and various other allied circuits will not

be dealt with as it hardly appears appropriate in a general discussion of this type.

## MIXER-OSCILLATOR OR FREQUENCY CONVERTERS

The next section we come to is the mixer-oscillator combination or frequency converter. The selection of tube or tubes depends entirely on the frequency of the incoming signal, and I suggest the following points should be considered:—

- The use of a converter as distinct from a mixer oscillator is desirable for simplicity.
- High conversion gain is desirable as it reduces the number of r.f. stages required.
- low noise level is desirable.

Taking converters first, the following tubes are satisfactory for the frequency indicated in order of preference:—

Up to 14 Mc.—ECH35, 6SA7, 6K8, 6J8.

14 to 60 Mc.—ECH35, 6K8.

60 to 200 Mc.—Nil.

The ECH35 is capable of results equal to any other combination up to 60 Mc. and its use on all frequencies up to this is recommended.

Taking mixer-oscillator combinations, the following tubes are satisfactory for frequencies indicated in order of preference:—

Up to 14 Mc.—6L7, 6J7, etc.

14 to 200 Mc.—6AG5, 6AK5, 6AL7, 954, 9001, EF50, 6AC7.

All tubes listed are satisfactory provided an efficient r.f. amplifier system is used. Even the EF50 functions very well at 200 Mc.

Local oscillators could use any of the following:—

Up to 14 Mc.—Anything.

14 to 60 Mc.—955, 9002, 6J5G, EF50.

60 to 200 Mc.—955, 9002, EF50.

Following are some figures on converters and mixers which show their relative merits:—

Type	Conversion Conductance	Equivalent Noise Resistance
ECH35	650	32,000
6SA7	450	78,000
6K8	350	91,000
6J8	290	36,400
6L7	375	55,500
6AG5	1,150	8,880
6AK5	1,170	9,150
954	320	32,000

These are rather striking as they show the advances that have been made in modern tube manufacture. It shows also clearly that the ECH35 is the only combination tube worthy of consideration and that the 6AG5/6AK5 types are the ultimate.

Having selected our mixer tube we now have to decide on the r.f. section. The first decision will be one or two stages. Two things must be considered:—

- The noise generated by the mixer.

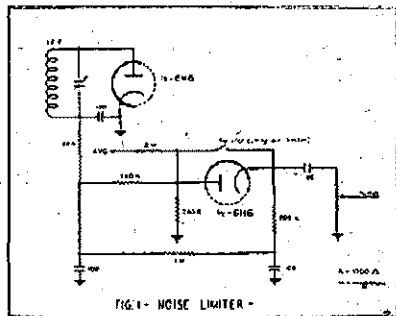

FIG. 1—NOISE LIMITER

\*University Grounds, Melbourne.

### (b) Mechanical.

If we use a low noise mixer then one r.f. stage would be sufficient. The ECH35 represents the lowest efficiency which could be tolerated under these conditions. Anything else requires two r.f. stages ahead for best results. The following table gives characteristics of the various tubes available.

Type	Transconductance	Equivalent Noise Resistance
6AG5	5,000	450
6AK5	5,100	380
RL7	7,000	700
EF50	7,000	1,200
6AC7	9,000	2,500
8U7	1,600	1,400

There is one very important factor which is not indicated in this table and that is input loading. As the frequency increases the input admittance increases. The input admittance is defined as the current flowing into the control electrode divided by the voltage that is applied between this electrode and the cathode. The admittance can be represented by a hypothetical condenser shunted by a resistance. The capacity is called the input capacity and the resistance is the input resistance.

At higher frequencies the input capacity represents the lowest value of C obtainable in the circuit and above a certain frequency, optimum L/C ratios cannot be obtained.

The input resistance depends on the frequency and consists of two components. The first due to the fact that the electrons take a finite time to travel from the plate to the cathode and the second due to cathode lead inductance. In practice these two factors are of comparable orders of magnitude.

Figures for input resistance are hard to come by but the following table gives some approximate values.

Tube	Input Capacitance	Input Resistance at 60 Mc.
6AG5	6.5 p.f.	20,000 " " "
6AK5	4.3 " "	20,000 " " "
RL7	5 " "	10,000 " " "
EF50	7 " "	3,000 " " "
6AC7	10 " "	1,000 " " "

The 6AK5's gain appears slightly preferable because of its lower input capacity.

As we go up in frequency the gain and efficiency of the pentode starts to drop and its equivalent noise resistance increases. Let us consider what actually produces noise in a receiver.

### RECEIVER NOISE

In a receiver, the amount of noise energy reaching the output will depend on the bandwidth. In fact it is directly proportional to the square root of the bandwidth. Obviously the wider the bandwidth the more noise spectrum will be received and the noise energy at the output will be increased. It should be clearly under-

stood that the noise output is in no way dependent on the received signal and is due to various causes as will be discussed later.

The main causes of receiver noise are as follows:—

- (a) Shot effect.
- (b) Thermal Agitation.
- (c) Partition noise.
- (d) Extraneous causes.

Let us consider each cause separately.

**Shot Effect.**—In a valve, the electron stream from cathode to plate is caused to vary in accordance with a voltage applied to the grid. The resulting plate current will vary in accordance with this grid voltage and in this way amplification takes place. If, however, the electron stream varies for some other reason, the plate current will vary in accordance with this other reason as well as in accordance with the grid voltage. This other variation gives rise to what is called noise. The shot effect results from the fact that the stream of electrons flowing from the cathode to plate is made up of a series of particles rather than a continuous fluid. As a result, the electron flow to the plate is somewhat irregular, resembling hailstones striking a metal surface, and this gives rise to slight irregularities in the plate current and hence noise.

An electric current may be regarded as a flow of electrons in a conductor and in any conductor there will be numbers of free electrons circulating within it. The speed at which the electrons circulate is dependent on the temperature being zero at absolute zero ( $-273^{\circ}$  C.). Therefore at normal temperatures there will be minute currents circulating in the various circuits of the receiver. In practice they are very small and the only important circuit is the grid circuit of the first valve, as minute currents will give rise to variations of grid voltage which will be amplified throughout the receiver as noise.

**Partition Noise.**—With multi-electrode valves this is probably the most serious source of noise, and is the factor which determines the maximum signal to noise ratio obtainable from a receiver using pentode valves as r.f. amplifiers. In such valves the electron stream passes first through the grid which is usually at a small negative potential with respect to the cathode and will not effect the electron stream appreciably so long as its voltage remains constant, the condition for no signal or constant signal (neglecting other causes of noise). It then passes through a screen grid which is at a high positive potential with respect to the cathode and will therefore attract electrons. Some electrons will strike the screen and thus pass into the screen circuit, thus giving rise to

normal screen current. The number that strike the screen and the number that pass through will vary according to a statistical law. Thus if ten electrons leave the cathode, one may strike the screen and nine pass through, or two might strike the screen and eight pass through. In other words the numbers will vary from instant to instant and thus the plate current will vary in a random manner giving rise to noise.

Further, after the electrons pass through the screen they have to traverse the suppressor grid before reaching the plate. This grid is usually at cathode potential and hence there is a point of low potential between the plate and suppressor. This will cause a slowing up of the electrons and will cause slow electrons to hesitate between striking the plate or returning to the screen. Thus we have a further cause for variation of plate current and thus more noise.

**Extraneous Noise.**—Little need be said about this as nothing much can be done about it in receiver design. It is due to voltages induced in the aerial by electro magnetic waves set up by electrical machinery, etc., and may be simply classed as man-made noise. It gives some trouble in receivers; and must always be suppressed at its source.

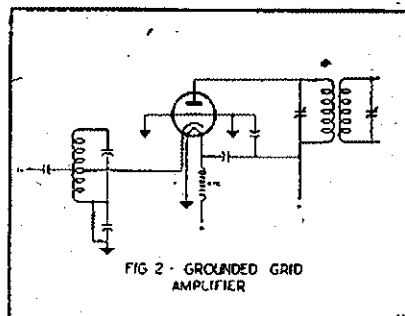

### THE R.F. AMPLIFIER

It has been stated that partition noise is the most serious offender and hence it would appear that the use of pentodes as r.f. amplifiers is not beneficial and that triodes should be used. However conventional triodes will oscillate when grid and plate circuits are tuned to the same frequency due to feedback through the high grid-plate capacitance. (This is very small in pentodes and hence they do not oscillate under these conditions.) In order to stabilise the triode we may neutralise it. This is in effect taking some of the energy from the plate circuit and introducing it into the grid circuit in such a way that it is in phase with the grid excitation and hence out of phase with the feedback energy from the plate circuit from the grid-plate capacity.



Then it can be seen that the valve will not oscillate provided that the two feedbacks are equal in amplitude.

Now consider the circuit shown in Figure 2. It will be at once noticed that the grid is at earth potential and that the input signal is applied between the cathode and the grid. Thus the grid effectively shields the plate from the cathode and prevents any feedback through the valve itself. Hence if the input and output circuits are screened from one another, oscillation is manifestly impossible. The construction of a CV66 type of grounded grid amplifier is fairly conventional except that each end of the grid is brought to a separate pin at the base and all leads are very carefully screened from one another. Owing to this construction and to circuit detail the thermal agitation noise is also reduced. This is due in part to the fact that the input impedance is very low and hence the grid circuit impedance is low. Hence thermal agitation will set up smaller voltages than if the circuit was of a higher impedance.

If the maximum benefit is to be obtained from such an amplifier the signal must be raised well above noise before it is introduced into the normal receiver. Therefore it is usual to use two such grounded grid stages. The use of two stages is not due entirely to the triode having a lower amplification factor than the pentode as conventional pentodes at very high frequencies have fairly low amplification. In fact using CV66 type valves at 200 Mc. a gain of 7 db per stage has been obtained while acorn pentodes give a gain of say 10 db but it must be remembered that the grounded grid amplifier gives this gain in signal to noise ratio over the maximum obtainable with conventional tubes.

This circuit gives no advantages at frequencies below 100 Mc. when such tubes as 6AK5s, etc., are available.

In the light of this information let us design a receiver whose efficiency is a maximum at 50 Mc:—

- (1) R.F. stage, 6AK5 seems the logical choice. Only one required.
- (2) Mixer, 6AG5.
- (3) Local Oscillator, 9002.
- (4) I.F. channel, 10.7 Mc. Three stages of 6SK7s.

Efficient and simple converter:—

- (1) R.F. stage, 6AK5.
- (2) Converter, ECH35.

Many other combinations will suggest themselves but these are considered the optimum.

# CLEARING THE ETHER—SERIES

## II PART X

By G. GLOVER,\* VK3AG

### THE AUDIO SYSTEM

To date we have dealt with the r.f. portion of the transmitter as far as the aerial tuning unit. In order to complete the picture we will proceed to discuss the audio side, power supplies and control circuits in that order.

As the microphone is the basis of the phone transmitter, we will commence at this point.

**Microphones.**—There are numerous types of microphones in use today, each type has certain advantages and disadvantages dependent upon the job it is being called upon to perform. The ideal microphone for communication work should possess:—

- (1) Uni-directional pick-up characteristics, in order to reduce unwanted sounds to a minimum.
- (2) Low impedance output, so that reasonable length of cable can be used without undue interference (electrostatic).
- (3) Flat response from 200 to 3,000 cycles (accepted speech range).

**Frequency Clipping.**—For Amateur use we are only concerned with the transmission of the human speaking voice, in other words all we require is clear enunciation; hence, as long as the frequency range employed provides articulation required, transmission of frequencies above and below this range may be classified as unwanted.

Experience indicates that the range 200 to 3,000 cycles per second will provide the necessary "speech" channel. Suppression of lower frequencies conserves waste of modulating energy, and eliminates hum and low frequency pick-up problems. Suppression of high frequencies conserves band space (why hog the ether unnecessarily!), in any case this energy is usually lost over long transmission paths and/or in narrow band width receivers used for communication purposes.

**Volume Compression and Automatic Gain Control.**—In order to obtain the greatest results from a phone transmitter the carrier must be modulated one hundred per cent. on peaks, and high average level maintained. Let us consider what this means to the speaker. Firstly, he or she must maintain constant relationship to microphone insofar as distance and direction is concerned. Secondly, level of voice must be maintained constant. If variation occurs in one or both of these factors the result is

either overmodulation with consequent "splatter," or undermodulation resulting in considerable loss in side band power. Psychological effect upon the speaker of such an effort would be equivalent to a sentence of "hard labour" and as we are considering transmission from the viewpoint of a hobby we must do something to allow for the general tendency to wriggle in the chair, lean back and roll a smoke, or such like luxuries. By employing a "volume compressor," not only may we do all these things; but we can at the same time allow for the visitor who insists on interposing an occasional remark during a rag-chew. Talking of interposed remarks we must admit that it is going to be a bit awkward for the "Daddy" who is expected to act as nursemaid while "on the air," and will also call for some damping of other extraneous sounds. Still we must expect to make some sacrifices in order to obtain efficiency.

**Conclusions.**—From the foregoing discussion it becomes apparent that our ideal audio system will comprise:—

- (1) A uni-directional microphone with suitable frequency coverage.
- (2) A frequency clipping circuit to restrict range from 200 cycles to 3,000 cycles.
- (3) A volume compressor or peak limiter to maintain average audio level at pre-determined value.
- (4) Splatter proof modulator.

The best method of ensuring a good voice to noise ratio, and minimum interaction is to put the microphone pre-amplifier at the operating position and use a separate modulator unit; hence, the modulation system about to be described consists of two units, viz.:—

- (a) Pre-amplifier and clipper unit (speech amplifier).
- (b) Modulator unit.

**Speech Amplifier.**—This unit is designed to provide sufficient drive for modulator unit on the basis that microphone output is —60 db below 6 mW. level at an input impedance of 50 Ohms.

Figure 15 depicts schematic circuit of unit and we will deal first of all with the salient points of circuit from theoretical aspect.

**Stage 1**—The first feature worthy of note is the multi-shielded input transformer. This unit has (nominal values) 50 ohm primary and 60,000



(2) Lengthy grid wiring avoided and single shielded leads employed for any but exceedingly short leads.

(3) Where mica capacitors are employed as r.f. by-passes, wiring should be kept as short as possible, terminating on tube socket where practicable.

(4) For safety reasons plug must be used for power connection. If socket was used on chassis and plug on cable, live contacts would be exposed upon the withdrawal of plug from socket.

(5) V1 and V2 should be shock mounted in order to avoid likelihood of "microphonics," due to vibration of unit. This is a comparatively easy matter. Simply employ rubber grommets on mounting screws and use very flexible connections to the socket.

**Metering.**—The four-way polarized jack employed enables wandering meter to be plugged in to read:—

- (1) Cathode current of V1.
- (2) " " " " V2.
- (3) " " " " V3.
- (4) H.T. Voltage.

The actual jack assembly consists of centrally placed banana type plug with four sockets at 90° intervals on 1½" P.C.D., arranged to accommodate polarized plug with standard ¾" spacing.

The electrical arrangement of position (4) is such that R28 may be selected to give correct reading for meter having known internal resistance. For instance, if the internal resistance of meter is 100 ohms then R28 will have value of 500 ohms for full scale deflection of 300 volts. This resistor serves yet another purpose, that is; it ensures that voltage on the jack is extremely low and therefore rendered "safe."

Values of resistance quoted for cathode shunts in each case are for 100 ohm 1.0 ma. movement, and provide full scale deflection of 2 ma. for V1, 10 ma. for V2 and V3.

**Final Conclusions.**—It is obvious from the foregoing paragraphs that there is plenty of scope for individualism in audio amplifier design, the main considerations being carefully planned lay-out and attention to small, but significant, details.

Whatever form of construction is adopted provision must be made to completely enclose unit, in order to exclude dust and electro-static pick-up, etc. The design considered in this section is easily constructed, versatile and accessible.

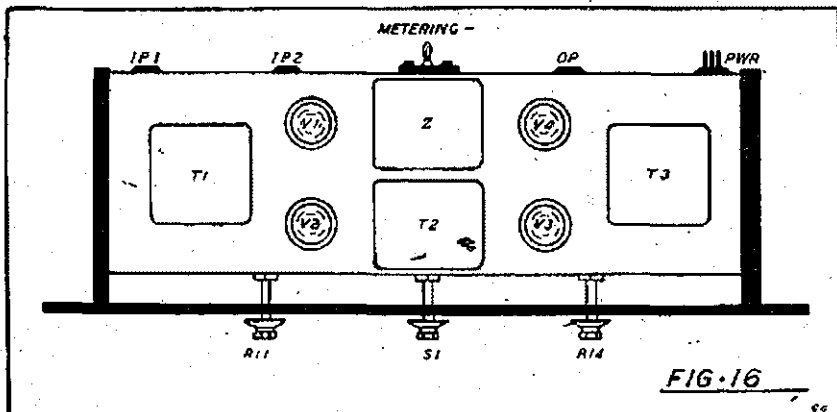

## "LINK" FREQUENCY MODULATED

### 10-VALVE MOBILE RECEIVER

TYPE 1305 — CRYSTAL CONTROLLED —  
FREQUENCY RANGE 30-40 MC.

Includes Inter-Comm. for  
2 operators

Size.—12" x 9-1/8" x 8 1/2"  
Power Output.—1/2 watt.

Freq. Deviation.—15 K.C.

Audio Response—

3DB 300-3000 cycles.

Operates off 12 Volt D.C.

Power Supply, Internal  
Dynamotor.

Power Input, 12/14 volts,  
4 amps. (12 V. accumulator)

Output Impedance, 500 ohm  
to feed 2 headsets.

Control. Direct.

Weight.—20 lbs.

Tubes include—

14W7—RF amp.

14W7—1st Det.

14C7—Crystal Osc. — Multiplier.

14S7—2nd Det. Crystal Osc.

14W7—1st Limiter.

14W7—2nd Limiter.

7A6—Discriminator.

7A6—Squelch Rectifier.

14F7—First Audio Squelch.

14C5—Audio Output Amp.

Inter-Comm.

Guaranteed new in sealed Cartons  
with Instructions and Service Manual .. £13/19/6

LIMITED QUANTITY AVAILABLE.

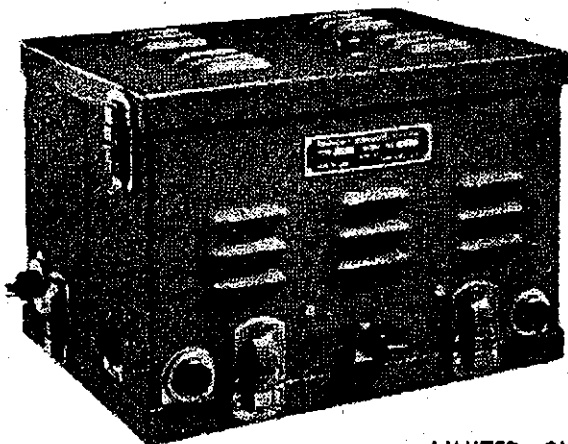

RADIO  
AND  
REFRIGERATORS

# VEALLS

ELECTRICAL  
AND  
LIGHTING

Sales  
and  
Service

MELBOURNE: VEALLS (SWANSTON ST.) PTY. LTD.  
231 SWANSTON ST. MELBOURNE  
PARRAMATTA: VEALLS (PARRAMATTA) PTY. LTD.  
225 CHAPEL ST. PARRAMATTA  
MAIL ORDERS BOX 21137

Telephone  
F 3145

# SUCH NICE PEOPLE

By "GREMLIN."

Seems as though I gave the beehive another kick with my remarks on the confusion in fone reporting. A lot seem to think I'm biased by "western" influence. Others reckon what was good enough in the old days still suits them. Matters little to me what system you use provided you use it correctly. Suggest some people buy a NEW copy of the Q Code and note the difference between QRK and QSA. At the same time take a peep at QRA and QTH. Time staggers on and it really isn't so hard keeping up with it.

Heard 3OC on c.w. recently. It's hard to believe the bug has been dormant so long now. Welcome back Ray with a nice crystal note. I guess you notice things different these days. No, nothing will surprise me now, not even should the Federal President emit a signal!

How do you like the key clicks these days? Plenty of them including 2ACX, 3AIR, 2AIB, 3PH, 3AHB 2AHQ and 3BP.

Thank goodness the battle of the v.f.o. hasn't hit us as hard as W land. It's commencing in VK2. Listening to

a W6 working ZM6AC the other night reminded me of tucker time in a pig nursery. Get in if you can and no matter if the other bloke hasn't finished. There is a VK2 who thinks it smart to slide up on a signal and interject. I'm not giving your call, same as you when you bust in, however your HAM operating is easily identified at any time on forty.

There was a time when the bad signal stood out, today the good are in the minority. If we all gave an honest report I think it would help a lot towards cleaning things up. If the other bloke has got a rough note with chirps and clicks, tell him so, don't say T9. If I work 2GV, 3DQ, 2PX, 3IC or 3EO it won't be T9.

Listened to 3AES call CX for five minutes the other night. Guess you meant CQ o.m. If you haven't a monitor suggest you get to work and have a listen to your dash clipping.

I'm certain nobody is interested in how 4WF eats his buns, be they buttered or neat. Your jam preference is a common brand and really doesn't need any advertising.

3ALE was staggering all over twenty on the 18th April, or rather 60 Kcs. of twenty, with a terrible note barely readable.

Was trying to do a spot of good for myself in the B.E.R.U. 2IQ and 6BW with fone on the low end of twenty didn't help. At least 6BW wasn't splashing over 50 Kcs.!

3BP if you must send chirpy v's, please speed it up from 7 w.p.m.—I timed them. It helps to keep me awake waiting for your call.

3YN could spare a watt or two of audio and still fill the carrier. Suggest you give the surplus to 5LC so he can throw away his poor quality stuff.

For a good clean c.w. signal, have a listen to 3DN.

VK7, you aren't being neglected. Truth is I only hear a few of you up my way and so far all good boys. Of course there are other occupations until 2200 in that fairyland of yours, and maybe I'm in bed before the wantons return to Ham Radio.

May I suggest to some of the vociferous gentlemen on forty and twenty who burn their 50 watts to yarn around the suburbs, that the use of the V.H.F. bands would serve the purpose equally well. You may also learn something down there, think it over.

## TECHNICAL BOOK & MAGAZINE CO.

297-299 SWANSTON STREET, MELBOURNE

(Opposite Old Melbourne Hospital)

Central 2041, Melbourne, C.I

We can arrange subscriptions to any of the following magazines:

### AMERICAN.

RADIO: .....	25/- year	COMMUNICATIONS: .....	24/- year
Q.S.T.: .....	27/- "	RADIO NEWS: .....	40/- "
C.Q.: .....	25/- "	RADIO CRAFT: .....	22/- "
SERVICE: .....	24/- "	SCIENCE DIGEST: .....	23/6 "
F.M. & TELEVISION: .....	48/- "	PROCEEDINGS INST. OF RADIO ENGINEERS .....	88/- "
ELECTRONICS: .....	97/6 "	POPULAR SCIENCE: .....	23/6 "
SPECIAL RATE FOR THREE YEARS: .....	195/- "	POPULAR MECHANICS: .....	23/6 "

### ENGLISH AND AUSTRALIAN.

WIRELESS WORLD: .....	25/- year	WIRELESS ENGINEER: .....	42/- year
PRACTICAL WIRELESS: .....	13/6 "	ELECTRONIC ENGINEERING: .....	33/- "
AUST. RADIO WORLD: .....	10/6 "	RADIO AND HOBBIES: .....	6/6 "
AMATEUR RADIO: .....	6/- "	SHORTWAVE MAGAZINE (English): .....	25/6 "

FOREMOST IN AUSTRALIA FOR TECHNICAL BOOKS.

## FEDERAL NOTES.

# DECISIONS OF THE FEDERAL CONVENTION

Last month in these notes we gave you a resume of the opening and closing remarks at the Federal Convention, held in Melbourne in April. This month, as promised, we have set out in slightly abridged form the decisions reached at the Convention. These decisions are of importance to all members, as they now form the basis of W.I.A. Federal policy for the coming year. They are as follows:—

### INSTITUTE ADMINISTRATION

In the Federal Constitution as finally adopted, clauses are to be inserted among the Objects of the W.I.A., covering the encouragement and assistance of persons and bodies interested in Amateur Radio, and the promotion of interest and participation in such pursuits.

The Federal Executive is instructed to compile a uniform Constitution for the Divisions, and the Convention laid down sixteen major points on which it considered uniformity to be desirable. We do not propose to go into these points here, but it is sufficient to say that uniformity to the degree laid down would ensure that the qualifications, responsibilities and privileges of the members of any Division would be the same as those of any other Division.

It was agreed that there must be the greatest possible flow of regular information from the Federal Executive to the Divisions, and it was decided that the Federal Executive should submit a monthly report of its activities to each Division.

This magazine came in for very full discussion, and it was agreed that it was impracticable at this stage for the Federal Council, through the Federal Executive, to take over full responsibility for its management, finance and publication. It was decided however that as the magazine is the Federal organ of the W.I.A., each of the Divisions must take a greater part than heretofore in its financing, and in other aspects of its production, including the provision of technical articles. To further this policy it was decided that in each Division there should be appointed a Sub-Editor, to handle within his Division such matters as Divisional Notes, circulation, technical articles, and advertising. Also all Divisions are to examine avenues of increasing the circulation within their areas.

In order to assist the objective of enrolling every licensed Amateur in the Institute it was decided that the W.I.A. should compile and publish a Station Handbook, as a companion publication to the P.M.G. Handbook,

covering such matters as guiding principles of station operation, standards of design, safety standards, etc.

Then followed one of the most important decisions in the history of the W.I.A., the decision instructing the Federal Executive to appoint a full-time Secretary. Certain minimum requirements were laid down, and more will be heard of this move when the Federal Executive has gone thoroughly into the matter.

In order to assist the Federal Executive to handle its funds with greater efficiency, it was decided that all Divisions should investigate the possibility of bringing into line the date of commencement of their fiscal years. This would be of considerable advantage as it would enable the Federal Executive to budget its expenditure.

It was agreed that any Division failing to pay its dues to the Federal body by the due date should not be entitled to a vote in Federal Council decisions, the Federal Council is, however, to have the power to grant an extension of time if it considers it warranted.

The matter of the expenses to Divisions of sending their representatives to Federal Conventions was discussed, and it was agreed that, where Divisional funds were inadequate to meet such expenses the latter should be paid from Federal funds and recouped by a levy on all Divisions.

Machinery for the transfer of members from one Division to another was agreed upon, to be incorporated in the uniform Divisional Constitution referred to previously.

The vexed question of Radio Clubs was then discussed at length, and proposals were made and adopted. The scheme worked out is subject to ratification by the Divisions, but if it becomes Institute policy it will undoubtedly be beneficial to both the Clubs and the W.I.A., and should promote harmony between the two. Since, as the Convention agreed, there are good reasons for the existence of both kinds of organisations, and further as in many cases the same Amateurs are members of both, there is every reason why they should get together.

### REGULATIONS

Quite a few resolutions were carried relating to the subject of the P.M.G. Regulations. As many of these cover matters which are currently under review by the P.M.G. at the instigation of the Institute, we are not in a position to comment in full, suffice to say that included among

them are the abolition of the present system of two-class licencing, abolition of the probationary period, permission for the use of F.M., Television and Pulse, and frequency allocations in the 21 Mc. and 425 Mc. regions.

The Federal Executive was also instructed to investigate the possibility of the division of the DX bands into phone and c.w. sub-bands as a purely Amateur matter on an International basis.

## Bright Star Radio

K. G. ALLEN  
VK3UH, Late R.A.N.

1839 Lower Malvern  
Road, Glen Iris, S.E.6  
Victoria

Phone: UL 5510

Prompt deliveries to all  
States.



As Illustrated  
40 or 80 metre  
AT or BT cut.  
Accuracy 02%  
of your specified  
frequency,

£2/12/6

Large unmounted 80 or 40  
metre, zero drift cut, £2;  
mounted 7/6 extra.

20 metre, zero drift mounted  
£5.

Crystals reground, £1 each  
Taylor Transmitting Tubes  
in the following types  
available soon: T20, T21,  
T40, TZ20, TZ40, T55,  
TB35, 866 JR. Place  
your order now.

Data sheets on request  
Filament, Power and Modu-  
lation Transformers made  
to order. Reasonable Prices  
Prompt Deliveries.

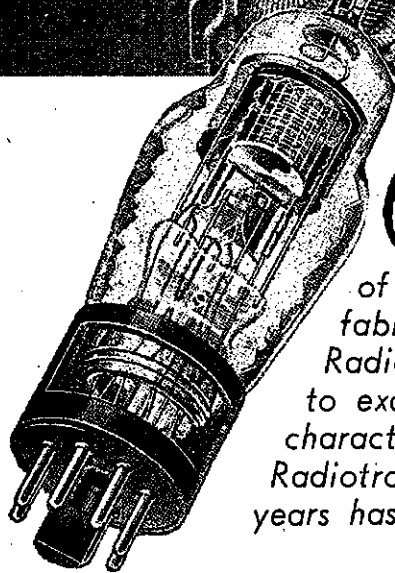

**O**PERATING WITHIN TOLERANCES of 1/1000 part of an inch, these winding machines fabricate the "grid" coils for use in Australian-made Radiotron valves. Only through constant conformity to exacting specifications, can that uniformity of characteristics be achieved and maintained in Radiotron production — which, for over twenty-five years has established Radiotron valves as —  
the world's standard valve . . .



**AMALGAMATED WIRELESS  
VALVE COMPANY PTY. LIMITED**

Administration ..... 47 York Street, Sydney, N.S.W.  
Manufacture ..... Parramatta Road, Ashfield, N.S.W.  
Distribution ..... Crown Street, Glebe, N.S.W.

vs

## INSTITUTE ACTIVITIES

Convention instructed the Federal Executive to look into the matter of the formation of a R.A.A.F. Reserve utilising Radio Amateurs.

It was agreed to organise Interstate Contests on all bands annually to perpetuate the names of Amateurs who lost their lives in the service of this country in the recent war.

A decision was made to divide the VK-ZL Contest into phone and c.w. on different days.

Arrangements are to be made with all member Societies of the I.A.R.U. for prior notification of details of all world Contests.

The Rules of the proposed Australian DX Century Club are to allow DX contacts made since the return of licenses, instead of since 1st January, 1947, as previously proposed.

The Institute is to investigate the possibility of taking steps to prevent commercial stations creeping into the Amateur bands as they now do.

Efforts are to be made for the co-operation of all concerned for the elimination of man-made interference at its source. Also efforts are to be made to see that Amateurs receive the same consideration as BCLs regarding such interference.

Each Division is to bring to the notice of its members the advisability of refraining from local rag-chewing on the 14 and 28 Mc. bands during DX hours, and to suggest the use of the V.H.F. bands for this purpose.

## GENERAL BUSINESS

The Federal Executive is to obtain information on how a Royal Charter for the W.I.A. may be secured.

A collated statement on W.I.A. policy is to be prepared by the Federal Executive.

At future Conventions the Federal Treasurer is to present a budget for the ensuing year.

Members of Federal Executive are to be nominated in future prior to the Convention, and after approval by the Federal Council, are to be present at the Convention as observers.

In future, not more than three of the five members of the Federal Executive are to be new members at the beginning of the annual term of office of the Executive, in order to ensure reasonable continuity of thought among the Executive from one term to the next.

Official broadcasts over Divisional stations will in future include from time to time call signs used by illegal stations operating in the Amateur bands.

The official station of the Federal Executive, VK3WIA, is to be put on the air as soon as possible.

The term "F.H.Q." or "Federal Headquarters" is now considered inept, and the Federal Executive is to be at all times referred to by its correct title.

## FEDERAL QSL BUREAU

RAY JONES, VK3RJ, MANAGER

Information that has now come to hand re stations using VK9 call signs in Papua immediately post-war, proves conclusively that the stations were unlicensed, unauthorised and probably operated by service personnel awaiting return to Australia. In all probability service equipment was also used. All cards held for these stations have been returned to the senders. Papua is now covered by VK4 call signs and up to time of writing there are four stations licensed, namely VK4OS, VK4NK, VK4AI and our old friend Wendel Wilkie, late of C.T.O. Melbourne, who signs VK4BI. All of these stations are located in Port Moresby.

It is recommended to all members that their QSLs should be standard post card size, and that where passed to a W.I.A. QSL Bureau for distribution, the call of the addressee should be written prominently on the back. Adoption of this procedure will greatly help the QSL Managers in the carrying out of their task.

Details of all Australian Contests are to be referred to the Federal Council, before publication, for approval.

Federal Executive is to prepare a design for a new membership Certificate for use by all Divisions.

Steps are to be taken to unify the information used by Divisions in membership drives.

A revised draft of the proposed Federal Constitution, together with an alternative submitted by the W.A. Division, is to be submitted to all Divisions shortly.

So concludes our resume of the business transacted at the recent Federal Convention. We believe all members will agree that the members of the Federal Executive will not have much time to think about anything apart from the Institute during the coming year!

## FEEDBACK

We note, in going through the Minutes of the Convention, that in publishing the Financial Statement last month, we omitted to add an explanatory note to the effect that the per-capita payments shown in the Statement are not necessarily in respect of the same period in the case of each Division. Actually the amount shown as paid by the Victorian Division includes an advance against the per-capita dues for the next period, which explains why Victoria has apparently paid much more than N.S.W. Also, in the case of the Queensland Division, their payment was received too late for inclusion in the Statement, which had already been sent to the Auditor.

A fat bunch of cards from W3EKK, Bernard Swedloff, covering his activ-

ities whilst in J9, also conveys a note to the effect that anyone who has not yet received a card, should not worry as he is QSLling each of the 1500 contacts in chronological order. Bernard also hands out the information that he will soon be in Manus Island in the Admiralties under a VK9 call sign. No need to tell me Bernard, I know, as your frequency on the 14 Mc. band, and that of thousands of v.f.o. birds who sit on your tail, unfortunately corresponds to mine, hi. It would be interesting to know who authorised the VK9 appendage to Bernard's new call sign. Guess just a handout for new-country-starved W stations endeavouring to hit the 150 country mark.

The information given in a recent issue relative to the new QSL Bureau for Japan has been confirmed by the ex-QSL manager, Lt. Col. Drudge Coates, J4AAC. The QTH of the new Bureau is again given: Major Lloyd Colvin, 71st Signal Service Bn., APO 800, U.S. Forces, Japan.

The R.E.F. are evidently determined that the alteration to the address of their QSL Bureau, should be given due prominence as a notification has been received with each of the last 12 despatches from the R.E.F. The new address is: Service QSL R.E.F., 48 Rue St. Laurent, Lagny (S. and M.), France.

The QTH of FK8VB is care of QSL Manager N.Z.A.R.T., Box 489, Wellington, N.Z.

G5UB/P active on 28 Mc. from a marine location, left New Zealand on 10th May and expects to be in Australia and Australian waters for a few weeks from the middle of May.

B.R.S. 9172, J. M. Fuller, writes from 11 Clifton Terrace, Winchester, Hampshire, England, soliciting pen friends among amateurs, preferably those who share his interests, which are electric and hydraulic control systems, radio control of model aircraft and midget radio receivers, cars, motorboats and small yachts. He is 26 years old and hopes to emigrate to VK shortly.

Addresses of Australian QSL Bureaux are as follows:—

Victoria (outgoing cards).—Frank O'Dwyer, VK3OF, 190 Thomas Street, Hampton, S.7.

Victoria (incoming cards).—Graham Roper, VK3ZB, 26 Lucas St., Caulfield, S.E.8.

New South Wales.—Jim Corbin, VK2YC, 78 Maloney St., Eastlakes, Sydney.

Queensland.—Eric Neale, VK4EN, 38 Felix St., Woolloowin, N.3, Brisbane.

South Australia.—George Luxon, VK5RX, 8 Brook St., West Mitcham, S.A.

Western Australia.—Jim Rumble, VK6RU, Box F319, G.P.O. Perth, W.A.

Tasmania.—T. A. Allen, VK7AL, 6 Thirza St., Newton, Tasmania.

## MONTH'S DX

"Arn" Wilkey (VK4BI), writing from Port Moresby, says as a new member of the W.I.A., and quite active up there on 14 Mc., he took it into his head to give us the dope on his rig, etc.

He has been on the air since 19th March, on 14 Mc. c.w. (and phone for about 3 weeks) until he decided to rebuild the rig. The old job was 3 stage xtal, 6V6G, 6V6G, 807. The new one nearing completion is 6V6G c.o. (7 Mc.), 6V6G buffer, 807 doubler (quad. for 28 Mc.), and an 813 in the final. It will run about 90 watts.

The antenna used most there is a vertical zepp, and gives very f.b. results, especially in the W direction. (He wishes there was a dead-spot in that direction.)

He reads with interest, in April's "A.R.," about v.f.o. attacks, on DX stations, by Ws. Has suffered at their hands on many occasions, the word having got around per "grapevine" that his QTH is Papua.

Some disgusting procedure takes place, such as calling before a QSO is finished in which case he makes it his business to note the caller and ignore him in future. Another whinge is the practice of Ws calling back when he calls "CQ DX NO W." That breaks his heart, and can't work any DX for the W QRM. Maybe he should be pleased to be so popular over there, but is far from it.

If some bandwidth on each side of a calling station was made a rule for v.f.o. men, we might get a chance to work some real DX.

Active Hams up there are VK4NK, VK4BI and VK4AI, who doesn't seem to get going very often. VK4OS has packed his bag and gone back to VK3, and he does not think he'll be up there again in a hurry.

VK4BI would be interested in 50 Mc. if there were any reasonably close stations for sure QSOs; but to hope to break through to the mainland does not seem to be worth the trouble. Several VK4s have suggested that he get going and work skeds.

"I do not know of any active VK9s up in New Guinea or the other Mandated Islands. I may be going up to VK9 in my job in a month or so, and if I do, will be able to provide the VK9 QSOs for the DX hounds over the drink," said VK4BI.

### WESTERN AUSTRALIA

28 Mc. Phone—This band showing decided improvement lately on what it has been since 1st January. It is anticipated that it will be even better than last winter, as many more Hams are now back on the air.

Europe.—Best from 1700 to 2200 almost daily and some excellent QSOs have resulted, among them being G8QX, G5OV, G3WH, G2CDI, G4NF from the old country, while the best from the Continent were PA0FB,

IIM7, SM5VW, HB9ET, F8TY, OIX7, and ZB1E.

Africa.—This band wide open for most countries from Algeria to Cape Province and these boys may be worked very consistently now from 1300 to 2000, particularly during the week-ends. ZSs 6DV, 6EG, 5BS, 6GI, 5Q, 5DA and 1AX, ZE1JU, ZE1JB, VQ2PL, OQ5BA, and SU1HF all made nice contacts.

Asia.—These boys have been active lately and apart from the usual VS1, C, J and VU QSOs, HZ1AB, VS7JB, VU7JU, EQ2L, YI2MW, YI2CA, and ZC6FP made good QSOs.

Oceania.—This area is providing more DX as the weeks go by, the ZLs in particular pounding through. KG6AE, W6ONP/KW6, KH6FC and W9OTK/KJ6 all being f.b. contacts.

Central America.—Not many of these boys about, but XE1KW and XE1RE were interesting contacts.

South America.—This Continent certainly provided some excitement during Easter when six VK6s made contact. Among the stations worked were YV1AN, HKs 3AO, 3SQ, 3DW and 3DD. The local boys who have W.A.C. on 28 Mc. phone now number seven.

North America.—Ws are in the majority by far of the DX from the Continent, and may be worked between 0800 to 1300, although one surprise was KL7FM around midday.

14 Mc. Phone—Europe.—Becoming more spasmodic late evenings as the winter draws on, although during the afternoon from 1400 to 1700 should provide, and has provided, some good QSOs when one can get through the VK2/3 QRM. Gs 6GN, 6GM, 3UQ, 5MY, 6ZO, 2WW, 5VB, 4OI, 8AC and 5OV, GI4QY, GM7SQ, ON4PZ, IIUE, F7AJ, being the best of those worked from 2400 to 0300 over week-ends.

Africa.—The boys from the dark Continent are still very active from 2000 onward nightly. ZSs 5M, 6LF, 2CI, 5Q, 6EU, 6BW, 6HT, 5EQ, 5CY and 4AY, ZE1JD and VA2HC making the best QSOs.

Asia.—These "locals" still pound through nightly, the Js and Cs seem to be multiplying in number rapidly from the new calls heard on the air. VS4BJ is the pick of the pile worked.

Oceania.—Some more of the rare birds getting active of late and are not difficult to work providing one is not beaten to it by a VK2 or VK3. K6ETF/KC6, Canton Island in the Phoenix Group, was a good QSO, and VR4AA, Guadalcanal in the Solomons, took some chasing and was QSOd after waiting nearly two hours listening to him go through VK2 and VK3.

Central America.—Hams from this location are also growing in number as quite a lot of new blood has been worked this last month. CO2KB, CO2KO, CO2MG, CO7CX, XE2BY, XE2KA, XE2HY and VP9F made interesting QSOs.

## CORRESPONDENCE

W.A. Division, W.I.A.  
23rd April, 1947

Editor, "A.R."

At the last meeting of the Council of the Division I was instructed to write to you on the matter contained in the contribution by "Gremlin" in the current issue of "Amateur Radio." The Council desires to express our resentment at the reference to VK6 and the policy regarding "newcomers to Amateur Radio."

In contradicting the insinuation, we would point out that through the Radio Clubs in W.A., the student is encouraged to an extent apparently not known by "Gremlin." We assume that in welcoming the matter for this section you overlooked this paragraph.

If reference to individual experimenters is carefully and diplomatically done, it might prove of benefit.

Whilst also raising the foregoing we should like to see a fairer distribution of adverse comments, not hand-claps for VK3 and kicks for VK2.

Yours, etc.,

W. E. COXON, VK6AG,  
Hon. Secretary.

\* \* \* \*

82 Forrest St.,  
South Perth, W.A.  
22nd April, 1947

Editor, "A.R."

"Gremlin" fills a long felt need, and his pertinent remarks about the long winded CQ merchants, pre-historic signals, etc., are long overdue.

However, he should confine his remarks to facts, and not to matters he obviously knows nothing about. His slanderous comment on the VK6s in the April issue is very much resented by the gang here, as there is not the slightest foundation for his insinuations.

A glance at the VK6 list of licenses shows a rapidly mounting increase in numbers, hardly to be expected from a locality where newcomers are discouraged. I would suggest that "Gremlin" gets in touch with some of the newcomers and asks them their opinions.

The VK6s are in the game because it is AMATEUR Radio, and any form of commercialism is frowned upon here. If we do not seek to make a profit from the newcomer by blatant advertising that we will teach him for a suitable fee, or if we do not employ paid instructors, it is because we dislike commercialising Amateur Radio, not because we wish to discourage the newcomer.

Yours etc.,

S. C. AUSTIN, VK6SA.



# DIALS *with* KNOBS ON!



## MINIATURE DIAL

This useful dial of 2" diameter, is engraved 0-100 degrees, and fitted with a fluted instrument knob. It is available either for direct drive, taking a 1/2" spindle, or fitted with a precision 10-1 reduction slow motion drive. Two finishes are supplied, matt black or matt silver with contrasting engraving. An index strip is supplied. Fixing is by two 4BA bolts, which are supplied.

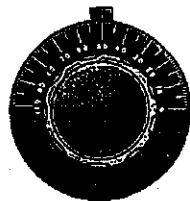

Cat. No. 595 Direct Drive 2" Dial, Black finish 10/-  
 Cat. No. 638 Direct Drive 2" Dial, Silver finish  
 Cat. No. 597 Precision Slow Motion 2" Dial, Block finish £1/3/2  
 Cat. No. 639 Precision Slow Motion 2" Dial, Silver finish

## MINIATURE POINTER KNOB AND DIAL

The metal dial is printed in black 0-10 on light background. Diameter 1 1/2" with 3/8" hole. The knob is polished black bakelite and has moulded white indicator line. Length 1 1/2", hole aperture for 3/8" spindles.  
 Cat. No. 425 . . . . . 3/1



## FULL VISION DIAL

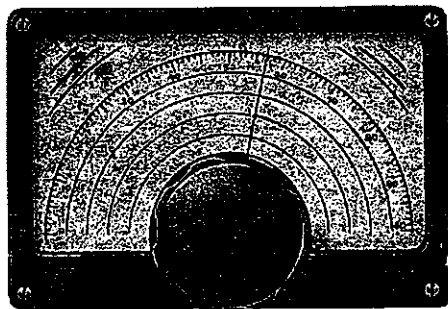

A most useful dial for all types of receivers, test oscillators and similar equipment. The dial escutcheon measures 6" long by 4 1/2" wide. The scale is 5" across. The outer scale is marked 0-100 degrees and three other scale lines are provided for the user to mark in his own calibrations as desired. Two spare printed scales are supplied with each dial. A large fluted instrument knob is fitted. The drive mechanism has a reduction ratio of 10-1, is free from backlash and has a beautifully smooth movement. Cat. No. 598.

## SLOW MOTION DIAL

Slow Motion Dial fitted with vernier reading device, 3 1/2" diameter scale and large fluted instrument knob. Reduction ratio 10-1. This model is finished in matt black with white fillings.

Cat. No. 594 . . . . . £1/9/7

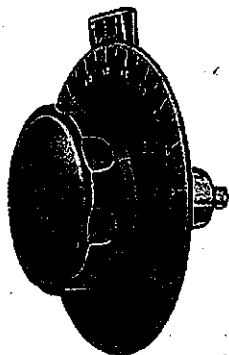

*These are but portion of the Specialised Range of*

# EDDYSTONE

**DIALS AND KNOBS**  
*now available from your distributor*

- VICTORIA: J. H. MAGRATH & CO.,  
208 Little Lonsdale Street, Melbourne.
- N.S.W.: JOHN MARTIN PTY. LTD.,  
116-119 Clarence Street, Sydney
- QUEENSLAND: CHANDLERS PTY. LTD.,  
Cnr. Albert and Charlotte Sts., Brisbane.
- WEST AUSTRALIA: CARLYLE & CO.,  
Hay Street, Perth, and 397 Hannan Street,  
Kalgoorlie.
- STH. AUSTRALIA: GERARD & GOODMAN  
LTD., 192-196 Rundle Street, Adelaide.
- TASMANIA: W. & G. GENDERS PTY. LTD.,  
53 Cameron Street, Launceston.

Australian Factory Representatives:

**KEITH HARRIS & CO. PTY. LTD.**

51 William St., Melb. Phone MB 2119

# MARCONI SCHOOL OF WIRELESS

(Conducted by Amalgamated Wireless (Aust.) Ltd.)

## AMATEURS

Special course to qualify candidates for P.M.G.  
Amateur Certificate Examinations.

**NO PREVIOUS EXPERIENCE REQUIRED**

The Theory standard of this course is sufficient to qualify students for the First Class Amateur Operators' Certificate Examination. After completing the course the student's Morse standard only should decide whether he applies for First or Second Class qualification.

**NIGHT CLASSES** . . . . . 6 months (one night weekly). Next term commences 4th July, 1947.

**CORRESPONDENCE** . . . . . 8 months—courses can be commenced at any time.

## OTHER COURSES

**SERVICE MECHANIC** - NIGHT CLASSES commence 4th July, 1947.  
CORRESPONDENCE can be commenced at any time.

**P.M.G. COMMERCIAL CERTIFICATES** . . . . . DAY OR NIGHT CLASSES commence 1st August, 1947.  
(Enrolment to be commenced by 24th July, 1947).  
CORRESPONDENCE can be commenced at any time.

**MATHEMATICS** . . . . . NIGHT CLASSES commence 4th August, 1947.

**MORSE TELEGRAPHY** - DAY AND NIGHT CLASSES (Sounder of Oscillator) commence at any time.

Call, 'Phone or write for full particulars:—

47 YORK STREET, SYDNEY

Telephone B 0522

163 QUEEN STREET, MELBOURNE

Telephone: MU 9161

### POST THIS NOW

MARCONI SCHOOL OF WIRELESS  
Box 2516 G.P.O., Sydney

Please send me without obligation full details of your courses.

NAME . . . . .

ADDRESS . . . . .

## DIVISIONAL NOTES

### NEW SOUTH WALES

Secretary: Peter H. Adams, VK2JX  
Box 1734 G.P.O., Sydney.

Meeting Place: Science House, Gloucester and Essex Streets.

Meeting Night: Fourth Friday of each month.

The V.H.F. section of the Division was re-opened post-war on 9th May and monthly meetings will be held on the second Friday of each month at Science House, Sydney. The N.S.W. V.H.F. officer was elected Chairman. C. Fryar (2NP) will do the job, Vice-President F/O L. Page (2YQ), Secretary Mr. Lindsay, Publicity Officer John Moyle (2JU). The future of the Division was discussed at length and a complete list of V.H.F. station frequencies compiled. The meeting was well attended and 3VV was a visitor.

The Treasurer of the Division, Basil Dale (2XX), is on the high seas and should appear shortly with a ZS call sign. Basil has left to take on a job as secretary of a spinning mills in South Africa. 2XX will be missed, he did a splendid job as Treasurer and had a torrid time dealing with Disposal gear finance.

Sixteen members have nominated for election to fill the seven vacancies on the Council, they are as follows: P. H. Adams (2JX), B. H. Anderson (2AND), T. R. Anthony (2TR), E. Barlow (2GQ), S. T. Clark (2ASD), J. B. Corbin (2YC), L. D. Cuffe (2AM), H. F. Dent (2AHU), G. W. Dukes (2WD), C. Hicks (2ADV), C. Hutchison (2YP), R. C. Meadows (2ARM), M. H. Meyers (2VN), J. M. Moyle (2JU), D. W. Reed (2DR), A. W. Thurston (2AV).

Office Bearers and Council will be shown in the next issue. Disposal gear to country members has been despatched and the possibilities of obtaining further gear seem remote.

#### WESTERN ZONE

2HC heard on 2.5 Mc. once or twice; still using gasoline engine for his power. — 2WH has a new junior op. He visits 2II and 2ACU one Sunday and 2NS and 2OF the next. — What happened to the phantom car, Jack? — 2AMR not very active, has a 15 watt Bendix xmitter. — 2ACT good QRP fone from batteries. — 2TG still gets his share of 14 Mc. DX. — 2ALX is the only one to have an AT20 going well on telephony. — 2NS, with a new AMR300 receiver, is amongst the DX. — 2IE heard one day, why not try again Phil? — 2RF, Broken Hill, on 7 Mc. occasionally; rest of the gang prefer 14 Mc. — We must not forget 211 with his push button all-band rig and f.b. quality. Please send Western Zone notes to 2QA, Nyngan.

#### NORTH COAST AND TABLELANDS ZONE

2AEU often heard on 7 and 14 Mc. using a modified class C wavemeter as a v.f.o. — 2RK hopes to be

# GLO-RAD

## SOLVES YET ANOTHER PROBLEM!

The experimentally minded Amateur has always been faced with the problem of getting special parts, etc., made at reasonable cost. Recent progress in V.H.F. and Micro-wave Techniques has further complicated this problem.

"GLORAD" is now in a position to cater for YOUR requirements, large or small.

Send sketches and full details to:—

**GLORAD ENGINEERING SERVICES**  
186A Riversdale Road (Cr. Robinson Road)  
**HAWTHORN ————— VICTORIA**

Phones: Day—WA 3819. Night—WX 3440

more active in the future, now on 7 Mc. — 2PA switches bands a lot, nice results from a folded dipole. — 2AEY consistent on 7 Mc. fone. Bill is undecided on the design for the new receiver. — 2AIH makes a hole in 7 Mc.; busy on alterations to the AT20. — 2NY is active on all bands. How's the c.r.o. Roy? — 2SL has nice signal on 7 and 3.5 Mc. — 2ZP on 7 Mc. fone and c.w. — 2SH and 2PA report 2II holidaying at the Port and has lost some whoppers. Send notes to 2AFP at Casino.

#### COALFIELDS ZONE

2XT still mainly on 7 Mc. fone. — 2YO busy with service work and not on much; talks of a 14 Mc. rotary and new rx. — 2KZ gets fine results from 4 half waves in phase on 28 Mc., and the xmitter goes down to 50 Mc. Has a 28 Mc. rotary under test. — Nil heard of 2DG and 2TY. — 2LB QRL in Sydney with examinations. — 2MK after working on 7 and 14 Mc. turns up on 28 Mc. with a plumber's delight. — 2ADT still going strong on 28 and 14 Mc., 60 odd countries on 28 Mc. fone. Jack is the local grinder and can be found on many frequencies; toying with idea of xtal filter for new rx. — 2PZ still collecting much gear and threatens to be going strong in about 4 years!! Now on 7 Mc. fone. — 2YL with new rig on 7 and 3.5 Mc., 109 countries up post-war, has ideas of building up new rx. and something for 50

Mc. — 2VS reports a contact on 166 Mc. between 2VS and 2BZ, the first in Newcastle? Send your notes to 2YL at Cessnock.

#### SOUTHERN ZONE

2OJ, like the Arab, departed up north on holidays, the rx is being re-vamped, Army job used now. — 2GG with new 3 stage job (6V6, 6V6, 807) knocked off some Yanks, nice work. — 2ANQ steadily re-building rig and associated gear. — 2VK occasionally splits ether and enjoying his leave. — 2APW goes on leave in May and hopes to bring back pieces to go with recently acquired 455 Kc. xtal (ex-W.I.A.) for rx. — 2EH sends the dope from Wagga, tnx. — 2BW, 100 watts to 813, 28 and 14 Mc. verticals and good DX. — 2TH, p.p 809s and how the DX comes back. — 2PJ post-war Ham prefers c.w. to fone. 6V6 and 807 rig, and re-building v.f.o. — 2AID, 809 does honors on 7 Mc. fone and c.w. Also has two 60 ft. sticks (wish I had them, 2APW). — 2ANT dwells under shadow of 2EH's zepp, why not call on Ern and give us the dope.

Mr. J. Macintosh (VS2AA) would be extremely grateful to receive replacements of cards which the Japanese looted. The two call signs affected are VS2AF and VS1AA, and the period is 1934 to 1939. Mr. Macintosh will be delighted to receive a card confirming any of his old contacts. The address is Mr. J. Macintosh, Postal Department, Kuala Lumpur, Malaya.

## VICTORIA

Secretary: A. B. D. Evans, VK3VQ,  
Box 2611 W.G.P.O., Melbourne.

Meeting Night: First Wednesday of  
each month.

Meeting Place: Radio School, Mel-  
bourne Technical College.

### "FOOD FOR R.S.G.B." APPEAL

At the general meeting of the W.I.A. Victorian Division, held on the 2nd April, a proposal to establish a "Food for R.S.G.B." Appeal was agreed to and a committee consisting of VK3AJE, VK3ALE, VK3UH and VK3UM was appointed to conduct it.

The newly-formed committee commenced operations immediately and from a door collection and Disposals gear sale raised £20 for the night. The Division Council agreed to contribute at the rate of 1/- for 1/- raised on the door collection, which amounted to £13/14/-.

The General Secretary of the R.S.G.B., G6CL, was contacted by Airmail, notified of the scheme, and his co-operation sought on the distribution of food parcels at his end. A letter was received back from G6CL, conveying his deep appreciation to all concerned, of the "true expression of the Ham spirit."

The committee immediately despatched 14 food parcels and two parcels containing soap, to G6CL who is arranging distribution. This consignment cost £15/13/-.

The attendants at the last general meeting on the 7th May, again made very generous contributions to the Fund and this time £18 was realised in the box collection. The Committee here wish to convey their most grateful thanks to both VK3JJ and VK3XJ who have made available gratis, two 813 tubes and sockets for sale. These sales will be conducted at the June and July meetings and proceeds will go to the "Food for R.S.G.B." Appeal.

To date, four broadcasts on the Appeal have been made from 3WI. These broadcasts have appealed to the country amateur for donations to the R.S.G.B. Appeal. No doubt, due to various circumstances, the results of these broadcasts have been disappointing. The Committee therefore consider that volunteer organisers should be appointed in each of the country zones, to contact zone amateurs in person.

VK3YV, Howard Wohlers, has been appointed official "Food for R.S.G.B." representative in the N.E. Zone, while VK3QC, Bruce Plowman, fills the same position in the S.W. Zone. Amateurs in these Zones may now send donations direct to these organisers.

The committee would be very glad to receive names of any country amateurs willing to conduct this worthy Appeal in their zone. It is intended

that these volunteers should become members of the committee. Names should be sent to the Secretary at the earliest. When the zone organisers get into full swing, special acknowledgements of zone donations will be made in the weekly broadcasts through VK3WI.

Finally, the committee appeal to all to keep the donations rolling in and thereby give the Appeal the success it so justly merits. Cheques, money orders, postal notes, etc., should be made payable to the Wireless Institute of Australia, Victorian Division, at Melbourne, and a note enclosed stating that the money is for the "Food for R.S.G.B." Appeal.

For further news of the Appeal, tune your sets to VK3WI on 7 Mc. every Monday night at 7 p.m.

### MEMBERSHIP

Past members when seeking re-admission to the Victorian Division will be required to submit a new application form and pay 2/6 entrance fee if they have been unfinancial for a period exceeding twelve months. The above was passed at Council meeting on 13th May, 1947, and is effective forthwith.

### T.A.C. NOTES

**Committee.**—Due to pressure of business, the present Chairman of the T.A.C., Herb Stevens (3JO), has found it necessary to hand in his resignation. Consequently, at the last Committee meeting, a general re-organisation was discussed. The Committee elected George Glover (3AG) as the new Chairman, and Bill Mitchell (3UM) as Secretary.

We must here mention the sterling work done by our retiring Chairman during the very difficult period of the war years, and hope he may still find time to carry on the good work he initiated with the T.A.C.

**V.H.F. Group.**—At the April meeting of this group, a very interesting and informative lecture was delivered by Dave Medley (3MJ) on V.H.F. receivers. The substance of this lecture is to be published in an early "Amateur Radio." Les Wirsu (VK-3ALW) provided an interesting talk on "1300 Mc. Technique" at the May meeting.

**Receiver Group.**—Due to transport difficulties, the attendance at the inaugural meeting of this group was limited. However, a general discussion on noise limiters took place, and it is intended to give a visual demonstration on the c.r.o. of noise limiters in operation at the May meeting.

**Standard Frequency Transmissions.**—By the time these notes appear in print, standard frequency and band edge location transmissions will be under way. Details of future services will be given over VK3WI in the weekly broadcasts.

**Libraries.**—New books received this month are Philips Manual of Practice for Servicemen, and the A.R.R.L. Handbook for 1947.

New items of equipment have been added as follows:—

Type C Wavemeter, category B;  
Air Ministry Type Absorption  
Wavemeter, category B;

Four 0-1.5 Amp. Thermocouple  
category B.

# Low Drift Crystals

FOR  
**AMATEUR  
BANDS**

ACCURACY 0.02% of  
STATED FREQUENCY

3.5 M/C and 7 M/C

Unmounted . . . £2 0 0

Mounted . . . £2 10 0

12.5 and 14 M/C Funda-  
mental Crystals, "Low  
Drift" Mounted only £5.

Spot Frequency Crystals  
Prices on Application

Regrinds . . . £1 0 0

THESE PRICES DO NOT  
INCLUDE SALES TAX.

**Maxwell Howden**  
VK3BQ

15 CLAREMONT CRES.,  
CANTERBURY, E.7.

# IRC

TYPE BT  
*Metallized*  
INSULATED

# RESISTORS

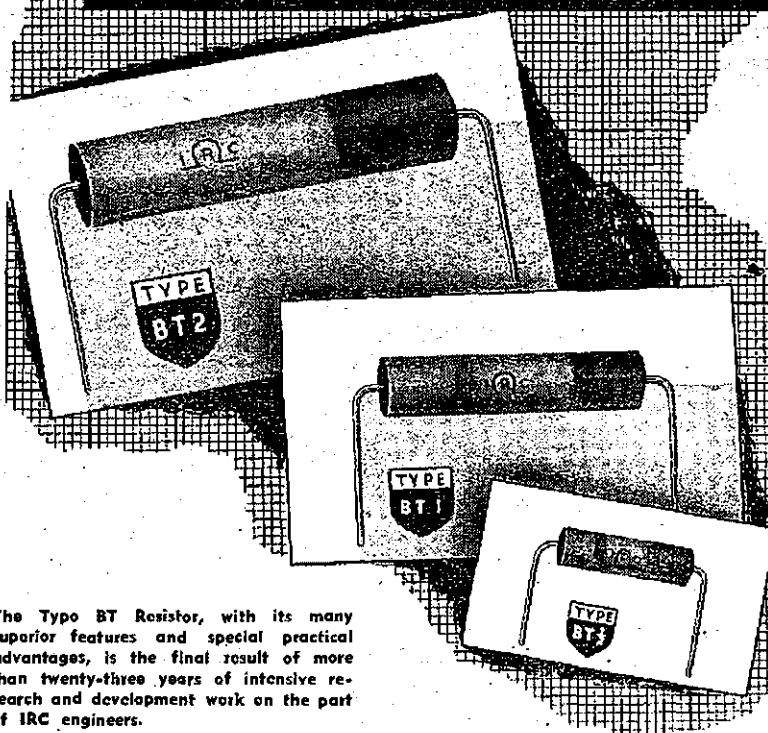

The Type BT Resistor, with its many superior features and special practical advantages, is the final result of more than twenty-three years of intensive research and development work on the part of IRC engineers.

The time-tried Metallized filament principle is retained, but the ingenious construction, firmly based upon sound engineering principles, ensures lower operating temperatures with proportionately higher wattage dissipation in a conveniently small, sturdy light weight, fully insulated unit with an exceptionally low noise level.

Moisture cannot enter. No possibility of protruding. Element is completely sealed and insulated by molded bakelite.

Famous Metallized Filament Type Resistance Element—known for its dependability since the first days of Radio.

Insertion of wire leads inside hollow tube on which Metallized filament resting to permit rapid heat dissipation. Leads draw heat out of resistor.

Heavily ground, flexible special alloy leads for quick, easy soldering. Leads anchored inside of insulation cannot turn or pull loose.

Note: Diameter approximately half actual size of BT-1 Resistor.

Etched, positive contact between resistance element and wire leads cannot be broken or become "open."

Available in  $\frac{1}{2}$  w., 1 w., and 2 w. sizes  
Sole Agents for Australia:

## Wm. J. McLELLAN & CO.

BRADBURY HOUSE, 35 YORK ST., SYDNEY • PHONE: BX2508

## QUEENSLAND

Secretary (acting): F. Nolan, VK4 JU, Box 638 J, G.P.O., Brisbane.  
Meeting Place: State Service Building, Elizabeth Street, City.  
Meeting Night: Last Friday in each month.

At the general meeting held on Friday, 2nd May, Mr. Herb Sprenger (VK4ES) gave members an account of proceedings at the recent Convention. As the affair is reported in Federal Notes, there is no point in repeating it all here. The decisions made at the Convention were duly ratified by the meeting. One of the steps taken at the Convention was to increase the price of "Amateur Radio." This, among other things is to assist in finding the where-with-all to pay the Federal Secretary when appointed. The increase will, in the case of this Division at least, be probably borne without additional membership charges.

The VK4 Division is in a position to obtain a Disposals Transmitter, the said job to serve as a basis for a permanent 4WI. In order to purchase same it has been decided by Council that Council members will contribute sufficient funds to make the purchase, thus conserving Institute funds, which are not as high at the moment as one could wish. The contributions by Council members will, of course, be in the form of a loan.

Speaking of 4WI you country men will be pleased to know (if you have not been listening to 4WI) that we are going to give the broadcasting of lectures a trial. The first one, by 4FN should present no difficulty and we will endeavour to put them across when ever possible.

There's not much news this month, the Annual Dinner having stolen the show, but one more point in closing—it has been decided to retain the present room on a monthly basis to assure continuity of tenure until a permanent room can be found, ahem!—at a suitable rental.

### 1947 ANNUAL DINNER

The second post-war Annual Dinner of the Queensland Division was held at the Anzac Hostel, Wickham Terrace, on Wednesday, the 23rd of April, and was attended by some forty-six members and visitors. The Radio Inspector's Department was represented by the Chief R.I., Mr. Conry, and Mr. Graham. Several representatives of the trade were also present and during the course of the evening the President (Mr. A. E. Waly, 4AW) reminded the gathering of the willingness of the trade to assist by donating pieces of apparatus for use as prizes during the evening. In opening the function the President extended a welcome to all present and proceeded to outline the Institute's work during the past twelve

# A.G. HEALING

LIMITED

MANUFACTURERS AND  
DISTRIBUTORS FOR.....

Electrical and Testing Instruments for all purposes made to British Standard specifications. Each instrument is accurate, + or —, to 2 per cent., and parts are heavily plated to prevent corrosion even under tropical conditions. "Healing" Electrical Meters equal the best imported types and will give accurate service for long periods under the most exacting conditions.

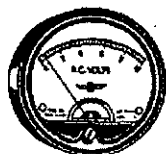

No. 10A round production mounting Black Bakelite Case.

Type No. 30A 4" square semi-flush Black Bakelite Case.



No. 20A 2½" round flush mounting Black Bakelite Case.

These, and all other Healing Radio Electrical Testing Units, are manufactured in our own factories and available from A. G. Healing Ltd.

OTHER INSTRUMENTS INCLUDE:

Oscillators — Multi-Testers — Signal Tracers, etc.



ALSO MANUFACTURERS AND DISTRIBUTORS FOR

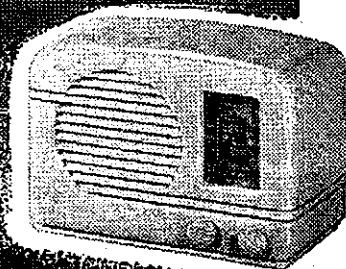

## Golden Voice RADIO

A. G. HEALING LTD., MELBOURNE, SYDNEY, ADELAIDE

months. On the credit side he mentioned the inauguration of the very successful 4WI broadcasts; the satisfactory QSL service, 489 parcels of cards being handled in 12 months; the Library service, still in its infancy, but what a promising toddler! Also progress in the V.H.F. Section, not forgetting 4HR's achievements in that field.

The hope was expressed that the coming year would see more sectional activity; pre-war phone, c.w. and country sections being cited as examples. The President also discussed the ceasing of student classes, pointing out that under present conditions it was not possible to run classes on a sound business-like basis. It was promised, however, that as soon as conditions permitted, classes would be resumed.

Mr. Conry, the Chief R.I. in VK4, conveyed to the assembly his pleasure in being present and spoke of the excellent relations between the Institute and his Department. He complimented the Queensland Amateur on his high standard of behavior as compared to other States, and continuing in the same vein as his chief, Mr. Graham appealed for the Amateur's cooperation in stamping out the pirate menace.

Mr. Herb. Sprenger (VK4ES), Queensland's delegate to the recent Convention, gave a brief outline of that event and promised to answer any questions relating there to at the next general meeting (see report elsewhere).

We are sure a good time was had by all those present, amongst whom were VK2AC, VK4s: AW, RT, ES, ZU, HR, KB, KF, KH, VJ, TR, PR, AB, MW, CH, JF, ZX, FJ, UL, SR, UU, CZ, CS, FY, FL, BN, RC, FB, FN, DL, AP and friend, and Messrs. Conry, Graham, Edgar, Foster, Keracher, Gabriel, Beale, Gilligan, Huxley, Crockett, Coles, Volker and Birmingham. To those who sent their apologies we say "Hope to see you next year."

## SOUTH AUSTRALIA

Secretary: E. A. Barbier, VK5MD,  
Box 1234 K, G.P.O., Adelaide.

Meeting Place: 17 Weymouth Street,  
Adelaide.

Meeting Night: Second Tuesday of  
each month.

The monthly general meeting for May was held at Kelvin Buildings where members were the guests of the Society of Illuminating Engineers. The original guest speaker being indisposed, Professor Sir Kerr Grant filled the breach and gave an interesting and informative lecture on "Neon Gas and its Application to Illumination." It is not necessary for me to elaborate on the lecture as the Professor is an old friend of ours

and always combines showmanship with technical ability. Naturally no Institute business was transacted and Hal Austin (President) proposed a vote of thanks to our hosts for the splendid evening, which was received with acclamation.

The writer has been appointed sub-editor for this magazine for VK5. I like the title, but if my experience is any guide it is just another method of handing out some more work. Ho Hum!

Any Divisional Secretary or Treasurer having trouble in securing new members should try my scheme. Any of the young men who come to call on my daughter, must first join the W.I.A. before they get past the kitchen. If you doubt that this works ask associate member Bob Turner.

The appearance of the "Gremlin" in "Amateur Radio" has been received with mixed feelings in VK5. Some like it, others dislike it. Personally, I am neutral as well as being pure.

I am in receipt of a letter from an anonymous reader who says that he has never read notes like mine, and also includes some choice tit bits concerning a certain very high frequency meeting. Regarding the tit bits they will come in handy should I ever decide to become a professional black-mailer, but as for my notes I don't know whether to feel complimented or insulted.

Several members have commented to me that although Bob Manuel (5RT) spent quite a lot of time during his recent lecture in explaining the fact that super regens were taboo, he still used one for his practical demonstration. What about it Bob?

It did not take long to find a job for new Council member George Ramsay. He is in charge of the newly formed disposals scheme patterned on the VK6 idea. No information as yet to hand regarding results, but if you want to buy or sell, George is your man.

One of the latest QST articles was having a slap at this "we" business on the fone bands. Apparently quite a few of the phone boys are never quite alone in their shacks. They have a decided tendency to eliminate the first person singular in favour of the first person plural. They say "we" did this and "we" did that or "we" are going out or "we" are stopping in. Why this "we we" business has crept in is beyond most Hams. Possibly they have little men surrounding them or on their shoulders. "We" don't know. My apologies to QST.

## FIELD DAY

The Sports and Field Day has now become a pleasant memory, and it is with regret that I say that I was unable to attend through no fault of my own. Having a wife and "seventeen" small children necessitated my

# COMMUNICATION RECEIVER

A.M.R. 200

AUSTRALIAN VERSION  
OF

**Hammarlund**  
SUPER PRO  
FOR SALE

XTAL FILTER

15 VALVES

BAND SWITCHED

5 BANDS

160

80

40

20

10

BAND SPREAD  
CAN BE SUPPLIED IN  
RACK COMPLETE WITH  
POWER SUPPLY AND  
SPEAKER PANEL.

Also—

25 FT. STEEL TOWER  
FITTED WITH LADDER,  
IN TWO SECTIONS  
READY FOR REMOVAL.

## VK3CU

34 BARRETT STREET,  
ALBERT PARK,  
MELBOURNE

working on this particular Sunday and therefore it is with pleasure that I hand the pen over to Joe McAllister who will describe in his own words the wonderful time that was had by all.

Well the Sports and Field Day of the W.I.A. South Australian Division arrived at long last, and with it a beautiful Autumn day, something to tempt even Jack Strafford out of his shack. The bus, attended by an escort of members' cars, left the Adelaide Railway Station at 10 a.m.

after Hal Austin had taken a photo or so. Picking up many members along the route we eventually arrived at National Park about 11.15 a.m. The oval was a picture of green sward and leafy trees, an ideal setting for a Ham gathering. The first item was the hidden transmitter, attracting two starters only, the other promised starters were apparently too busy policing the V.H.F. bands to see that no super-regens were being used.

**VK3NU**

## Major Radio & Electrical Co.

189 GLENFERRIE ROAD,  
MALVERN

WM 1814 U 9354

**SPECIAL ! !**

### TRANSFORMERS.

Multi Match Modulation Transformers. 75 watt, mounted in die-cast metal clamps. Write for full specifications, £4/19/6. Prompt delivery.

### Power Transformers —

Wound on extra large core of highest grade stalloy. Any voltage or wattage. Reasonably priced with short delivery period.

METER SCALES— Suitable for "Disposal" Pullin meters. Two types, Volt-M.A.-Ohm and Valve and condenser tester. 2/- each, Post Free.

### CHASSIS, RACKS, PANELS

We specialise in chassis and panels to your specifications. Write, enclosing full particulars, for a quotation.

The committee meanwhile were organising other items such as married and single women's races, throwing the rolling pin, three legged race, pinning the tail on the donkey (no not you Wykeham, sit down), and bowling at the stump. Doc Barbier apparently had the idea that he had to miss the stumps, or were they wifes?

The cricket match was quite exciting although one or two would have scored more if they had held the bat by the thin end. Of course lunch was held during all this excitement, and with all the hot air being blown about at the copper, the water should have boiled much quicker.

The 50 Mc. gang eventually arrived back with harrowing tales of the miles and miles they had walked, through tennis courts, bushes and high grass, etc. The hidden transmitter tricked them at times with the signals bouncing around off hills, wire netting and trees.

Ice cream and cool drinks were in demand by the kiddies, and the committee took a dim view of Cec Baseby rolling his pants up to his knees and sneaking off with a few ice creams. There are still a few empty bottles missing so would not be surprised to hear on the air that somebody has a couple of lemonade and lime juice bottles in push pull, modulated by a pair of stone ginger beer bottles in class AB.

The code reception through interference competition was a wow. The signals came over the p.a. and the bonnets of the cars were the writing desks. Then there as the lucky call sign competition with all manner and shape of QSL cards adorning the Hams. The highlight of the day was the Hams' race in which Dud Wilkinson (5WD) showed a surprising turn of speed and flashed over the tape with the speed of Bernborough.

The best built Ham's receiver attracted plenty of attention and the winner (5NG) is to be congratulated. The chin wagging and rag-chewing needs no description on my part and as for the final din when all the cars were sending morse code as they left, well! They say that the birds and beasts have not returned to National Park yet.

The President (Hal Austin) in presenting the trophies thanked all who had come along and the energetic committee for making possible such a wonderful day, and so until the next Field Day this is Joe McAllister saying thank you and here's hoping to see you next year.

When I had completed my getting back on the air, it was my intention to visit a few Ham shacks and have a look-see, but after seeing the way that Mrs. Hancock handled that rolling pin at the Field Day, I am somewhat deterred!

There was an unofficial entry into the hidden transmitter at the Field Day when Bronte Nitschke and Wykeham Bailey, after a couple of hours tramping over the hills and dales using their scoutcraft and bird-law or something, finally bailed up a poor innocent truck driver and asked him if he had a hidden transmitter. The driver said "yes," "but it belongs to the Electricity Trust and is on 9 meters." Well! Well!

## WESTERN AUSTRALIA

Hon. Secretary: W. E. Coxon, VK6AG, Howard St., Perth, W.A.

Meeting Place: Builders' Exchange, St. George's Terrace, Perth.

Meeting Night: Second Monday in each month.

The April meeting was held on the 21st of the month, with 6GM in the chair.

After normal general business was handled a couple of questions were put up by an anonymous contributor, and caused some diversion in the efforts to shed light on the subject.

6LW exhibited his portable transmitter used during the holidays at Gnowangerup, and it left many wondering where the S8 signals came from. A practical demonstration made it plain. An ingenious exchange of coils, etc., made it adaptable for all bands from 3.5 to 50 Mc. A suitable receiver to go with it is in process of growing up. A practical demonstration added interest to the description.

6EV then took the floor and 50 minutes devoted to the inner workings of a home made Bendix type frequency meter was very well spent. A discourse on the finer points added value and a practical test was made to determine the frequency of 6LM's rig, when on the 7 Mc. band. This demonstrated the co-operation that exists between W.A. Division Members, or was it the choice of lectures and subjects that made the combination so f.b.

The surplus gear officer did some good business during the evening. It is apparent that this activity is proving popular.

The meeting night has been changed to the 2nd Monday in the month and seems to suit everybody. The meeting closed at 11 p.m.

The May meeting was held on the 12th of the month, with 6GM presiding. Those attending were as follows: VK6s: PX, HL, BG, RF, EV, RU, KW, FC, LW, GB, SA, HM, DD, TX, MB, YZ, DS, DJ, FR, DF, AD, DN, GA, PW, AS, WT, LM, GC, LR, AG, GM and FL.

General business was speedily dealt with, and it was decided to hold a Forty Metre contest day on the 29th of June. All members will be given full details in the Monthly Bulletin.



A Forty Metre Field Day is planned for September, the June Contest day being a preliminary try-out, to arouse interest.

6LR, Len Reading, was farewelled, for he is leaving VK for ZS. Look out for a new ZS call sign as Len hopes to be back on the air in South Africa. We all wish him a good trip.

### PERSONALITIES

6HM is still very active on the 50 Mc. band. Charlie has quite a fine beam for this band. — 6DF has just completed a very f.b. 50 ft. steel tower. Hopes to have a triple 50, 28 and 14 Mc. array erected in a week or two. Maurie is doing things in fine style, fitting power drive mechanism as well. Maurie was W.A.C. on 28 Mc. phone during Easter, apparently making his mind up quicker about this death trap for aircraft. — 6RW, after a long absence from the air, Mick has turned up again with his usual f.b. signal. Welcome back again o.m. — 6BC had some fun, retrieving his motor boat at Rockingham the other week after a 60 m.p.h. gale. Now we know the real reason why Bert is still not on the air. — 6FL has purchased a tower for his beam, and it shouldn't be long before he has his array fitted up nicely. — 6DD is a very consistent VK6 on all bands. His V beam does a good job on South America on 28 Mc. John can certainly push his signal in that direction. — 6HL is another tower erector, "to make those signals go places," as Harry puts it. — 6WS heard on 14 Mc. in between his numerous trips around the State. How's the new exciter progressing skipper? — 6NL is becoming beam minded, and we think he will soon be erecting one. What about a Rhombic in the surrounding bush Vic? — 6GM has built up quite a nice compact 50 Mc. rig with an 807 in the final. The 50 Mc. gang have now a new station to include in their regular rag chews.

6KE heard on the air nightly with a nice signal. Keith is realising too that it takes an efficient antenna to get out from among the QRM these days. — 6AG is back on the air again on 7 Mc. Has some fine gear and we hope to hear him on the air more frequently. — 6 "Radio University" still keeps the air in Subiaco from getting cold. "Keep the electrons moving" is his motto. — 6KW has been spending some time tuning up the beam with the able help of good old Bill and 6RU (you ought to have seen Jim perched on the neighbour's roof with a field strength meter). — 6WT is back on the air again, at his new QTH at Waterman's Bay. A new receiver is part of Dave's gear and we believe it is the goods. — 6MU has been heard and worked by local VK6s in Perth over the last few weeks. Some of that queer short skip

that happens only occasionally. Believe that he W.A.C. on 28 Mc. phone during Easter. — 6DJ heard regularly pounding away and working a wealth of DX. How many countries up now Bill? — 6MW often heard from the northerly direction pumping forth the herbs in the direction of W. We believe Bill has the big transmitter on again now and is working some good DX. — 6PJ another 28 Mc. phone addict to make W.A.C. during Easter.

The lack of news from country Hams is disappointing, and 6KW would appreciate any notes from this direction. Send them in before the 10th of the month please.

## TASMANIA

Secretary: J. Brown, VK7BJ  
12 Thirza Street, New Town.  
Phone W 1328.

Meeting Place: Photographic Society's Rooms, 163 Liverpool Street, Hobart.

Meeting Night: First Wednesday of each month.

The April Council meeting took place at the residence of C. Walch (7CW), Osborne Ave., Sandy Bay, on the evening of Friday the 18th. Present were 7LJ in chair, 7BJ, 7CJ, 7CW, 7RF, 7CT and 7PA.

Minutes of previous meeting and correspondence were read and confirmed. Five applications for Associate Membership were received and passed for submission to the next general meeting. General business constituted taking the report of 7BJ, our delegate to the recent Conference. Joe emphasised the fact that the Conference was no holiday and from the report one can appreciate his point of view and we must say that the work done reflects credit on all concerned.

Maybe, with some items, we would have liked somewhat different outcomes but it would be an unusual position to find everybody in agreement all the time and no doubt if the work done, and the results achieved, can be put fully into effect our organisation must benefit.

General uniformity is something that should aid in the general organisation of such a scattered body as ours, subject of course to sufficient latitude being left to individual Divisions to allow for the meeting of matters peculiar to the Division. Items that were referred back to Divisions for consideration are to be put before the next general meeting when our decisions will be made.

At 11 p.m. Mrs. Walch called a halt for supper, to which all did justice, and after thanking the good lady for the trouble she had taken, the final details were settled down to and the meeting concluded at 11.30 p.m.

May general meeting was conducted to a good attendance at 8 p.m. on the 7th at the usual rooms. With the

Conference report to be taken and matters dealt with, it is a pity more of the gang could not have been present.

Those present were 7LJ in chair, 7BJ, 7CJ, 7RF, 7CW, 7OM, 7GR, 7CT, 7YY, 7MY, 7XA, 7TR, 7CL, 7NL, 7LL and 7DW; Messrs. R. Harrix, M. Watson, Koglin, Kruse, Milne, Fulton, M. Davis and D. H. Watson. Visitors: S. Cooper and D. Peek. Apologies from 7AL, 7ML, 7RY, 7LE, Messrs. R. Allenby and Durkin. Minutes of pre-

Australia's Largest Stock  
of

# All Radio Components

Chokes  
Coils  
Condensers  
Dials  
Intermediate Transformers  
Mose Equipment  
Potentiometers  
etc., etc.  
Resistors  
Soldering Irons,  
Speakers  
Test Equipment  
Valves  
Pick-Ups  
Power Transformers  
etc., etc.

Obtainable from

## Bloch & Gerber Ltd.

with which is associated  
the

### WELDON ELECTRIC SUPPLY CO.

46-48 YORK STREET,  
SYDNEY

G.P.O. Box 2282 M

Phones: MA 6291 (10 lines)

vious meeting were read and confirmed. 7LJ welcomed the two visitors.

7XA, desiring to leave early, then reported the progress made with the "Food for Britain" Appeal. 26 parcels being on their way up to just before Easter. He read a letter from G6CL expressing their gratitude and assuring us of their intention of giving every possible attention to distribution. G6CL said he had recently seen Chas Miller, VK7CM.

The "hat around" realised a further £7/6/6 as a final count, there being some confusion caused with odd pennies at the first and subsequent counts, everybody trying to create an even money balance at the same time, until the panic settled down. This was the best individual collection to date and a round figure total is somewhere over £22 by my reckoning, next month I will endeavour to procure the committee's figures.

The Field Day conducted on 20th April was again a success, in fact some even claim it even better than before.

Our Annual Dinner was then discussed and 14th June was decided upon and a sub-committee, consisting of 7RF, 7CT and 7CW, has been elected to attend to arrangements. 7MY has undertaken to attend to the accommodation and possible billeting for any northern or country members attending.

At a suggestion from northern members some alteration may be made to the rag-chewing sessions but it is proposed to discuss it with those who attend the annual meeting first. Sunday mornings have been suggested in lieu of Friday nights with an alternative of one Friday night and one Sunday morning each month to give each fancy an opportunity.

The main item of the evening was then brought forward when 7BJ took over to report the work and results of the Conference. General satisfaction was felt at the result of the work done and it is hoped the outcome of resolutions that concern Departmental matters will be received and treated in the manner we desire by the officials concerned, Conference has done its part.

Unanimous approval was given by those present to several proposals put up at Conference and referred to the Divisions. Uniform Constitution (subject to not interfering with any Divisional matter that is peculiar to that Division), a full-time paid Secretary for Federal Executive as detailed. Termination of the Divisional year at the same approximate time, thus allowing Federal Executive to be in a better position to know their financial position, etc. (per-capita income, etc.). The inclusion of "Amateur Radio" with the full members' annual subscription. (This necessitated

the increasing of the effective annual subscription to those concerned although actually, with magazine included, it shows a small saving over the two.)

This resume is to give those who were not able to be present an opportunity to know something of the outcome and as a guide only, details here being impossible. A hearty vote of thanks to our delegate was carried with acclamation.

VK7 is concerned about the new list of countries being published in U.S. magazines and eliminating VK7s' distinction as a separate country and our Secretary has been directed to write to A.R.R.L. and CQ objecting to same.

#### JOTTINGS

7AG and 7LJ have contacted 3CN since he was here recently and 7LJ had a long session on his last contact, it's as well the 30-minute limit has gone Lou! 7AG has been working portable in the Waddamana district recently—keeping 7JH company?

7WI broadcast on Friday 9/5/47 was run by 7BJ in 7CT's absence, but owing to trouble in the mike circuit, Joe put in quite a lot of the time talking to himself.

Official rag-chew night 7BQ, 7AB and 7XL were worked here and others are looked forward to. Local lads are asked to respect these even-

## RED LINE TRANSFORMERS & CHOKES

For the **F.F.R.** Amplifier

Type No. AR2

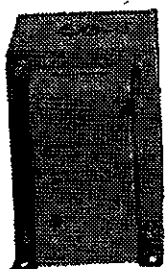

Type No. No. 5176



Type No. 50825



Type No. 102512



Type No. A.W.5

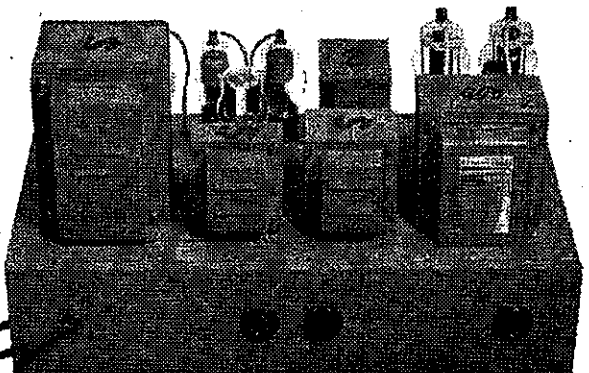

Pamphlet describing design and construction of the Full Frequency Range Amplifier available from:

## SWALES & SWANN

Technical Service,  
Wholesale and Manufacturers:

A. T. SWALES, Cent. 4773  
2 Coates Lane, Melbourne.

Trade Sales: ALLEN SWANN  
MU 6895 (3 Lines)  
157 Elizabeth St., Melb.

ings and observe some system of contact, possibly the worst worry is other States calling our lads, possibly not knowing just what is on. Maybe if all States had a common roster night for intra-State rag-chewing we could get away from this trouble.

7CW visited Sydney recently on holidays. He returned with a "mystery box." One way of overcoming the Disposals problem, but we hope it doesn't exceed the power limits.

Heard on phone on 7 Mc.—7DH, 7ML, 7MY. 7LJ is building new modulator so he won't be long. 7 Mc. conditions so poor lately that 7LJ suggests may have to migrate to 3.5 Mc. with Interstate Traffic Network skeds.

### THE FIELD DAY

The transmitter was that used on previous occasions, and made available by 7CW. It was located and operated by 7LJ and party. All previous rules and conditions remaining. Owing to the lateness of the season this year, another glorious day was experienced and as 7LJ elected to go inland for a change, this glorious atmosphere was more evident.

Tea Tree, a district on the eastern

side of the Derwent, about 12 or 13 miles air-line from the G.P.O. and in a northerly direction, was selected and by the courtesy of a local resident of the district, Mr. Newnham, on whose property is a recreation ground bounded by a creek and willow trees, the setting was ideal although cover for the party's cars was not so good.

For those who are not familiar with our aspect, the eastern shore viewed from Hobart is a rather tricky area, the Derwent can be crossed at three points and as many roads, leading in various directions, dissect the area some confusion is easily possible as was borne out when the first cars appeared 50 minutes after the start, only to head off on a by-road in the opposite direction after taking a bearing almost on top of the transmitter, much to the satisfaction of the operating party.

7CW, 7BJ and 7OM were seen approaching at 1050, take bearings at a point opposite the transmitter and at the junction of a by-road and then proceed away again via the by-road.

A few minutes later, 7LL appeared and did likewise, then some 10 minutes later he was noticed returning

with the previously mentioned three cars in close pursuit, further bearings taken at similar places as before apparently decided them, and a cross-country obstacle race by the four concerned, over fences and across the water jump, with 7LL in the lead, closely followed by 7BJ, 7CW and 7OM ensued and resulted in a split second finish in that order as stated, even a dead-heat was quite on the cards and a camera finish would have had much to commend it.

Twelve or more cars participated and only one had to finally "open his envelope." The party constituted Hams, wives and families, and friends and after lunch an afternoon of chatter and amusement was enjoyed.

A pennant is being provided for these events to be a perpetual trophy which will be held by the winner until he is next defeated, and this will then be one of the ceremonies of the day—presenting the pennant. This will go to 7LL at present who will retain it until the next competition or until defeated and as there is no further arrangements for the present maybe he will at least hold it until after the winter.

**A  
B  
A  
C**

**AUSTRALIA'S  
BEST  
AMPLIFIER  
COMPONENTS**

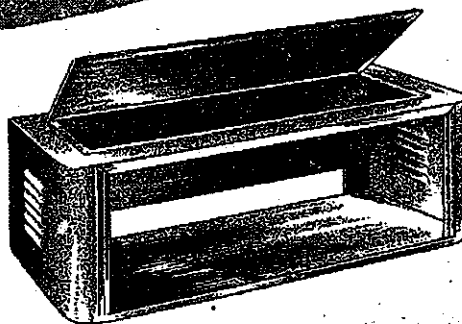

**ABAC  
Standard  
Receiver**

Or Instrument  
Case. Takes 19 x  
8½ panel with  
clear panel space  
17½ x 7½. Depth  
of case 11 inches.

MANUFACTURED BY

**TRIMAX TRANSFORMERS**

29-35 FLEMINGTON ROAD  
NTH. MELBOURNE, VIC.  
(Division of Cliff & Bunting  
Pty. Ltd)

## IN REVIEW.

# A.R.R.L. HANDBOOK, 1947 EDITION

Designed and written as an amateur radio communications manual, the 1947 Handbook retains its accent on practical utility, the treatment of radio communication problems having a down-to-earth constructional approach rather than a purely academic one. Its appeal to all in the field—from beginning experimenter to advanced amateur—is based on the thorough but non-mathematical presentation of comprehensive subject matter.

The nine chapters of the section devoted to principles and design comprehensively cover the theory of radio communications and design of amateur transmitting, receiving, radiating and measuring apparatus. Starting the reader with fundamentals of electricity and radio, it then presents to him a chapter on the operation of vacuum tubes, including circuit applications, from simple diodes through cathode-ray tubes to klystrons and magnetrons. There follow chapters discussing radio frequency power generation methods, radiotelephony, transmitter keying, receiver theory

and design, power supply, wave propagation and antenna systems.

The construction section of the present edition, first in five years to be produced wholly under peacetime conditions, has undergone extensive revision. Much new material has been added as a result of the year's work in the new A.R.R.L. laboratory in design, construction and thorough testing of apparatus embodying new ideas which were necessarily dormant during the war period. Beginning with a treatise on workshop practice, it then turns to a chapter on receiver construction, complete with all details for the building of various types of receivers, from a simple-two-tube affair to an eight-tube amateur-band communications superheterodyne. The construction of transmitting apparatus is likewise facilitated by a profusely illustrated chapter, containing also data on power supplies, metering, control circuits and station layout.

Almost a text in themselves, the chapters on receivers and transmitters for the very high frequencies have been completely re-written to include descriptions on construction of apparatus geared to the ever-changing trends of V.H.F. technique, yet still retaining features appealing to the beginning experimenter in this comparatively new field.

Under the heading "Emergency and

Portable," a discussion of the design and construction of appropriate apparatus offers valuable aid to the fore-handed amateur who wishes to be prepared for any eventuality. The constructional section of the Handbook is concluded with a chapter devoted to the design and building of measuring equipment—monitors, frequency meters, cathode-ray oscilloscopes and similar laboratory apparatus.

The third division of the 1947 Handbook is composed of a completely up-to-date revision of the tables of vacuum tube characteristics and miscellaneous data, and a chapter of timely information concerning amateur radio operating. The sixteen tables of vacuum tube characteristics occupy fifty pages and include complete data on more than a thousand tube types as well as base diagrams for socket connections. Miscellaneous formulae, charts and tables round out this storehouse of information.

The Radio Amateur's Handbook (twenty-fourth Edition, 1947), by the Headquarters Staff of the American Radio Relay League, of 632 pages, 6½" x 9½", including catalogue section and 10-page topical index, 1,257 illustrations including 96 charts and tables, 171 basic formulae. Available in Australia shortly, price 11/6 approximately.

## EASY MONEY

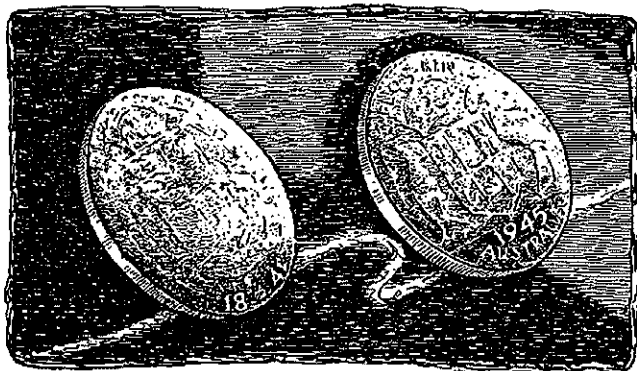

The desire to accumulate money in an unreasonably short space of time produces an unending group of victims for all kinds of get-rich-quick schemes.

The young man who begins by saving a few shillings every week and thriftily increases his store stands a better chance of spending the last half of his life in affluence and comfort than he who, in his haste to become rich, tries to obtain money by useless speculation.

*Money can be lost in more ways than won*

# THE STATE SAVINGS BANK OF VICTORIA

"WHERE YOUR SAVINGS ARE SECURE"



The Widest Possible Range in Town!

For the  
Amateur  
Broadcaster

**RADIO  
Parts**

Most hams agree that there is nothing to equal the variety and quality of radio parts now being offered by L. & H. and their retailers.

Ask your broadcasting pals about L. & H. equipment — see for yourself! The unsurpassed performance of all L. & H. components is known all over Australia—guaranteed thoroughly efficient, reliable and built for years of quality service.

Check up on your requirements now! Let this list help you—

MICROPHONES  
COILS  
BATTERIES  
METERS  
SWITCHES

VALVES  
VIBRATORS  
TRANSFORMERS  
CHOKES  
CHASSES

CONDENSERS  
SPEAKERS  
RESISTORS  
LINEFILTERS  
Etc., Etc.

Helpful technical advice readily given upon request. Obtain latest lists and prices from your radio house.

**Lawrence & Hanson Electrical** PTY. LTD.

33 YORK STREET, SYDNEY  
87 ELIZABETH STREET, BRISBANE  
120 COLLINS STREET, HOBART

172 WILLIAM STREET, MELBOURNE  
60 WAYMOUTH STREET, ADELAIDE  
20 PATTERSON STREET, LAUNCESTON

# Here's PORTABLE pleasure



It's a little beauty! The Aegis Voyager is a compact, efficient 4-valve battery-operated portable supplied in kit set form. Every part, including the miniature valves and Mini-Max batteries, comes to you in a well packed carton, all ready for assembly—and it's so easy to do with the complete instructional details. When finished it is only 8" x 6½" x 7" and every feature is typical of Aegis quality and ingenuity of engineering. This is the first kit set to be fully licensed by A.R.T.S. & P. which gives you full use of all patents . . . yet another triumph for Aegis.

with the  
**AEGIS 'VOYAGER'**



RETAIL PRICE  
in all Capital Cities  
**£16/7/6**  
(including Valves  
& Batteries)  
Attractive Discount  
to Amateurs.

#### FEATURES OF MODEL KP4.

WEIGHT :12 lb. assembled  
(packed for despatch—  
14 lb.).

BATTERIES: Genuine Ever-  
ready Mini-Max B. Bat-  
teries giving approx. 240  
hours life.

RADIOTRON miniature  
valves allowing for extra  
sensitivity and space-  
saving.

ROLA 3½" Per-Mag. Spea-  
ker.

CABINET durable Leather-  
ette covering.

AEGIS special Loop Aerial  
for high Q.

AEGIS J10 I.F.'s.

CHASSIS: Cadmium plated

## AEGIS

MANUFACTURING CO. PTY. LTD.  
MELBOURNE - AUSTRALIA

Distributors in all States include:—

MELBOURNE: Replacement Parts Pty. Ltd.  
J. H. McGrath & Co.  
Lawrence & Hansen Pty. Ltd.  
John Martin Radio and Electrical  
Pty. Ltd.

SYDNEY: John Martin Pty. Ltd.  
Geo. Brown Pty. Ltd.

# AMATEUR RADIO

JULY  
1947

JOURNAL OF THE WIRELESS INSTITUTE OF AUSTRALIA

## Fit PHILIPS



## Air Trimmers *and stay on the Beam!*



If you want adjustments that "stay put"—and what radio man doesn't?—then Philips air trimmers are the answer.

They're small precision trimmers, made on a concentric cylinder principle, with a minimum air gap. For you this means a large capacity in a diminutive space — in fact, Philips air trimmers can be built into the head of a coil-can, resulting in short connections, effective shielding and a saving in space.

Principal advantages of these thoroughly dependable trimmers are **CONSTANCY OF CAPACITY, ONCE ADJUSTED, and EXTREMELY LOW LOSSES.** But there are many others, as you will see from the characteristics at right. They'll prove how Philips air trimmers keep you on the beam!

### NOTE THESE OUTSTANDING CHARACTERISTICS

Maximum capacity	30 uuf
Minimum capacity	3 uuf
Control range	27 uuf
Total rotation angle	1080°
Capacity curve	linear
Insulation resistance	30,000 megohms
Parallel damping at 1500 kc. and 30 uuf	15 megohms
Maximum working temperature	60°C.
Test voltage	300 volts
Diameter	12.5 mm.
Weight	5.8 gm. (approx.)

PHILIPS ELECTRICAL INDUSTRIES  
OF AUSTRALIA PTY. LTD.  
SYDNEY : MELBOURNE : ADELAIDE  
PERTH : BRISBANE



FOR THE EXPERIMENTER & RADIO ENTHUSIAST

Registered at G.P.O., Melbourne, for transmission by post as a periodical.

6d.

*On the beam...*

*with KINGSLEY  
radio equipment*



The above photographs show the front and top views of the Kingsley K/CR/12, the post-war brother to the K/CR/11 (AR7). Model K/CR/12 is a Ferrotuned turret band-change unit, and is an advanced forward step. You will fill your log quicker with the aid of Kingsley Equipment.

KP7



**KINGSLEY RADIO**

KINGSLEY RADIO PTY. LTD.

380 St. Kilda Road, Melbourne, Victoria . Phones: MX 1159, MX 3653



# AMATEUR RADIO

Published by The Wireless Institute of Australia,  
Law Court Chambers, 191 Queen Street,  
Melbourne, C.1

**Editor:**

T. D. HOGAN, VK3HX.  
Telephone: UM 1732.

**Technical Editor:**

J. K. RIDGWAY, VK3CR.

**Notes Editor:**

R. W. HIGGINBOTHAM, VK3RN.

**Distribution:**

H. N. STEVENS, VK3JO.

**Business Manager:**

J. G. MARSLAND, VK3NY.

**Advertising Representative:**

W. J. LEWIS,  
20 Queen Street, Melbourne, C.1.  
Telephone: MU 5154.

**Printers:**

H. HEARNE & CO. PTY. LTD.,  
285 Latrobe Street, Melbourne.

MSS. and Magazine Correspondence should be forwarded to the Editor, "Amateur Radio," Box 2611W, G.P.O., Melbourne, on or before the 15th of each month.

Subscription rate is 6/- per annum, in advance (post. paid).

— IN THIS ISSUE —

Six Element Rotary Beam for 166 Mc. . . . .	3
DX Bookkeeping . . . . .	6
Federal Notes . . . . .	8
QSL Bureau . . . . .	8
Fifty and Up . . . . .	10
Month's DX . . . . .	11
Station Description . . . . .	12
Such Nice People . . . . .	12
Divisional Notes . . . . .	14
Victorian Zones, Map of . . . . .	23

## EDITORIAL



When the final decisions of the International Telecommunication Conference on Amateur Frequency Allocations are promulgated, we hope that a fair proportion of the spectrum will be allotted to Amateurs and that our already overcrowded bands will not be reduced still further.

With the present world wide increase in Amateur Stations, an increase in the width of our bands would be the logical step for the Conference to take and we sincerely trust that they will encourage a section of the community who have proved their national value.

When listening to many of the Commercial Stations who occupy a considerable portion of the spectrum for little or no apparent purpose, one can be pardoned for wondering just what justification there is for the continual emission of signals which appear to be using valuable frequency assignments, merely to ensure their retention against some possible future use.

Anyone who listens consistently on our bands will hear Amateurs who selfishly misuse our extremely small frequency allocations by transmissions which are purely social in character or who talk interminably, often repeating themselves three

or four times. This practice should make any thinking person consider that it is time for us to develop and use better operating procedure especially on our best DX bands.

At the last Federal Convention it was decided that each Division should bring to the notice of its members the advisability of refraining from local rag-chewing on the 14 Mc. and 28 Mc. bands during DX hours; suggesting as an appropriate alternative the use of the V.H.F. bands for that purpose. Also the Federal Convention decided to seek through the I.A.R.U. comment by international membership societies on the desirability of sub-dividing the High Frequency Amateur Bands into phone and c.w. sections with a view to presenting to the Federal Council such opinions for their consideration.

From the above it is apparent that efforts by the W.I.A. are being directed to the problem of using our limited allocations to the best advantage.

It is up to each Amateur to put more thought into each transmission, to ensure that we eliminate unnecessary repetitions, lengthy conversations, and over long calls.

W.R.G.

**NOW is the Time to Buy!**  
**-at HOMECRAFTS**  
 Come in and Inspect these  
**STAR BARGAINS**

*DISPOSAL VALVES*

VCR 139<sub>6</sub> 2 $\frac{3}{4}$ " CATH-  
 ODE 12 PIN BASE  
 plus Tax

**20/-**

EF 50 EXTRA HIGH  
 GAIN RF PENTODES

**17/3**

EA 50 MIDGET  
 SINGLE DIODE

Ideal for vacuum tube  
 voltmeters **14/-**

- ★ **Valve and Circuit Testers** **15 Gns.**  
 Reconditioned. Three Only Complete for Only
- ★ **TRAVERSING GEARS** - **£3/19/6**  
 Complete for Home Recording. Limited Quantity
- ★ **Velocity Type Microphones** **4 Gns.**
- ★ **2 Gang Condensers** - - **8/11**
- ★ **5-Inch SPEAKERS** - - **22/6**
- ★ **Console CABINETS** - - **£6/19/6**  
 (Uncut). Beautiful Finish. An Exceptional Bargain at

*Homecrafts* **PTY. LTD.** **CENTRAL 4311**  
 THE RADIO SPECIALISTS

Head Office: MELBOURNE, 290 Lonsdale Street, and at 211 Swanston Street, Melbourne.  
 139 Moorabool Street, Geelong. 307 Sturt Street, Ballarat. 100 Clarence Street,  
 SYDNEY. 26 Hunter Street, Newcastle. Hobart, Launceston, and Burnie, TASMANIA.

# A SIX ELEMENT ROTARY BEAM FOR 166 Mc.

By COLIN A. MACKENZIE,\* VK3ACM

The 166-170 Mc. amateur band offers many possibilities of carrying out interesting experiments on antennas and propagation that cannot be done on lower frequency bands by the average experimenter because of space limitations.

Up till the date of writing all those active on 166 Mc. are using vertical antennas, and, as in the past, there has been much discussion on vertical versus horizontal polarisation. A great deal of reading on this subject was done and, from evidence gathered, the following conclusions were arrived at. At wavelengths below 50 Cm. there is no observable difference between signals obtained with vertical polarisation and horizontal polarisation. As the wavelength is increased above 50 Cm. vertical polarisation begins to give better signals in the shadows of hills, etc., and horizontal polarisation out of the shadows. At wavelengths above about 5 meters, vertical polarisation gives better signals than horizontal polarisation, both in and out of the shadows, but the difference is greatest in the shadow and least out of it.

These conclusions, and the fact that all those already on 166 Mc. were using verticals, led to the use of a vertical antenna by the writer. Although I am not convinced yet as to which method is the best for this frequency, and would like to point out here that any change from vertical to horizontal polarisation on this band should only be made after exhaustive and well organised tests over different paths of varying contours.

The six element beam to be described could, with slight constructive alterations, be made to operate for horizontal polarisation if necessary, and is shown in Figure 1. It consists of two, three element vertical parasitic close spaced arrays, spaced one half wavelength apart and fed in phase. The feed line from the transmitter is 50 ohm co-axial cable, so at the point of feeding each three element beam is required to present an impedance of 100 ohms.

The driver elements consist of folded dipoles having unequal diameters,

3/8-inch diameter tube and 9 B. & S. bare copper wire being used. The centres of the 9 B. & S. copper wire on each folded dipole being joined by the phasing line, which actually consists of two quarter wave Q matching sections, designed to match the centre of the driven elements to the 50 ohm co-axial cable.

The ratio of diameters in the folded dipoles is  $.375 \div .114 = 3.29$ .

Now from the charts published in "Amateur Radio" May 1947, page 6, and assuming an impedance of 9 ohms at the centre of a plain dipole in a three element close-spaced parasitic array, the above folded dipoles have input impedances of 90 ohms each.

It is now necessary to transform this impedance of 90 ohms to 100 ohms, the reflected impedance required by each beam at the feed point. The transformation is carried out by the use of Q matching sections.

The characteristic impedance of quarter wave-Q matching sections is given by—

$$Z_c = \sqrt{Z_o Z_i} \dots \dots (1)$$

where  $Z_o$  = impedance at output of Q section.

$Z_i$  = impedance at input to Q section.

Substituting known values in equation (1)—

$$\begin{aligned} Z_c &= \sqrt{90 \times 100} \\ &= \sqrt{9000} \\ &= 94.8 \text{ ohms.} \end{aligned}$$

The characteristic impedance of a parallel conductor line is—

$$Z_c = 120 \cos^{-1} \frac{D}{d} \dots \dots (2)$$

where  $Z_c$  = characteristic or surge impedance.

$D$  = spacing, centre to centre of conductors.

$d$  = diameter of conductors.

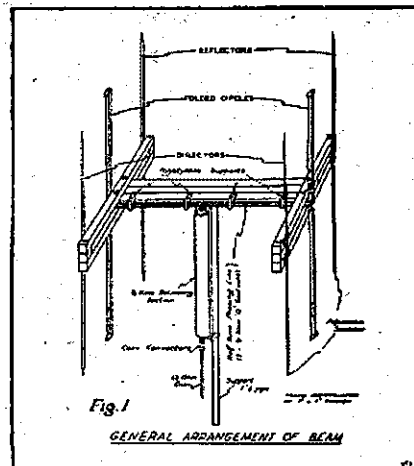

Using 3/8" diameter tubing and substituting known values in equation (2) we have:—

$$94.8 = 120 \cos^{-1} \frac{D}{0.375}$$

Solving for D we obtain:—  
0.498", say 1/2 inch.

To save calculations required for quarter wave Q matching sections, a chart is supplied showing surge impedance plotted against spacing/diameter ratio for parallel conductors. A word of warning should be added here about the usual formula as given in most handbooks for the surge impedance of parallel conductor transmission lines, i.e.  $276 \log_{10} b/a$ , where  $b$  equals spacing, centre to centre of conductors, and  $a$  equals radius of conductors.

This equation is very inaccurate for values of impedance below about 300 ohms, the error increasing as the value of impedance decreases. In other words it is only accurate when  $D$  is very much greater than  $d$ .

The length in inches of quarter wave Q matching sections—

$$= \frac{246 \times .95 \times 12}{\text{freq. (Mc.)}} \dots \dots (3)$$

The factor .95 is the propagation constant for parallel tube air dielectric line.

For 168 Mc. the length of a Q Section will be—

$$\frac{2804.4}{168} = 16.69 \text{ inches.}$$

As two such Q matching sections form the half wave phasing line, the overall length will be 33.38 inches, say 33 3/8 inches. This line is spaced by 4 polystyrene supports as shown in Figure 3.

\*34 Orange Grove, Camberwell, Vic.

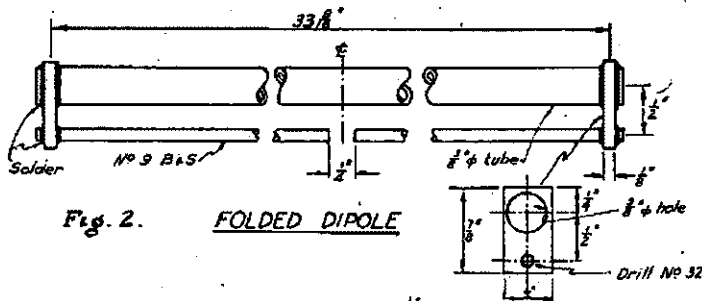

Fig. 2. FOLDED DIPOLE

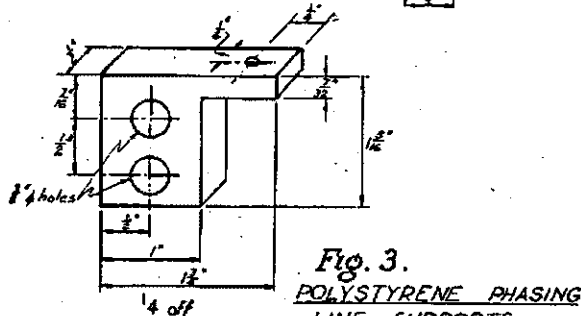

Fig. 3. POLYSTYRENE PHASING LINE SUPPORTS

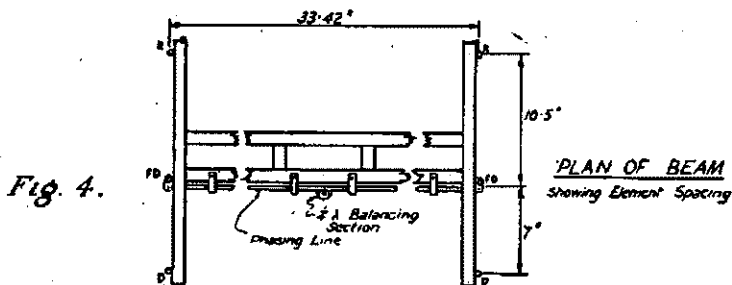

Fig. 4.

#### LENGTH OF THE ELEMENTS

The total length around the loop formed by the folded dipole is calculated from—

$$\text{length (inches)} = \frac{11450}{\text{freq. (Mc.)}} \quad (4)$$

$$= \frac{11450}{168} = 68.156 \text{ inches.}$$

Figure 2 shows the construction of the folded dipoles. The tubes and 9 B. & S. wire should be cut about 1/4 in. longer than required to allow for tuning.

#### DIRECTORS

The directors should be about 4% shorter than a half wave and the length is calculated from—

$$\text{length (in.)} = \frac{5540}{\text{freq. (Mc.)}} \text{ less 4\% } (5)$$

$$= \frac{5318.4}{168} = 31.657 \text{ inches.}$$

The directors should be cut to about 30 inches and adjustable stubs fitted in the ends to allow for final tuning.

#### REFLECTORS

The reflectors should be about 5% longer than a half wave.

$$\text{length (in.)} = \frac{5540}{\text{freq. (Mc.)}} \text{ plus 5\% } (6)$$

$$= \frac{5817}{168} = 34.625 \text{ inches.}$$

The reflectors should be cut to about 32 inches and adjustable stubs fitted in the ends to allow for tuning.

#### SPACING OF ELEMENTS

Use .1 wavelength spacing between driven elements and directors, and .15 wavelength between driven elements and reflectors. These spacings are shown in Figure 4 and are 7 inches and 10.5 inches respectively.

When first tried the beam pattern was lop-sided, necessitating pointing the beam in a different direction to that from which the signal being received was known to be radiating. This fault was due to feeding the beam with unbalanced co-axial cable thereby unbalancing the antenna and distorting the radiation pattern. To overcome this a line balancing section was added and had the desired effect.

Now much had been heard over the air about what was called a trombone balancing section, but after much thought and investigation this method was eliminated, because, as well as being a balancing section, the trombone is also a transformer section with a ratio of four to one, which means that for 50 ohm co-axial a load of 200 ohms would be required at the balanced output. The simplest balancing section was finally selected, this being the much used quarter wave balancing section.

Figure 5 shows the construction of this section. The length being given by—

$$\frac{2808}{\text{freq. (Mc.)}} \quad (7)$$

$$\frac{2808}{168} = 16.71 \text{ inches.}$$

The diameter of the outside cylinder is not important but should be made large enough to consider the section as having air dielectric.

Although the beam has not been tuned, the directors and reflectors only being adjusted to the calculated lengths, results in actual practice, considering the present height is only 22 feet off the ground, have been most promising.

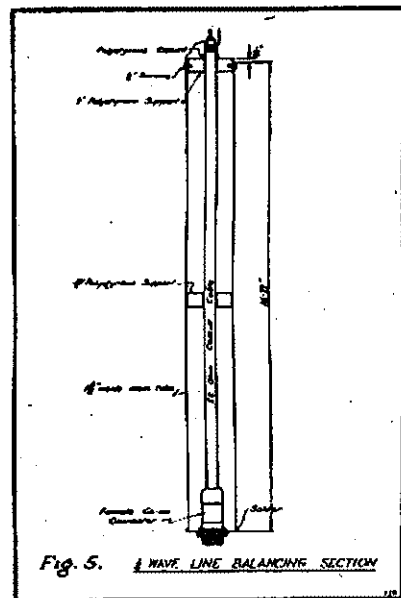

Fig. 5. 1/4 WAVE LINE BALANCING SECTION

A word of warning should be given regarding connection of feed to Q matching sections. This connection should be made in the exact centre of the half wave phasing line, otherwise "slewing" of the radiation pattern, due to phase differences between the two beams will take place, causing a similar effect to that caused by the unbalanced feed line.

Since erecting the beam just described, a different method of feeding has been worked out, and will be tried as soon as possible. In the writer's opinion the new method should be more successful and is worthy of a short description.

Instead of the unequal diameter folded dipoles, it is intended to use two 3" diameter tubes, i.e. equal diameters, giving a step up ratio of

4 to 1. This will give an impedance at end feed point of 36 ohms.

The quarter wave Q matching sections will have a characteristic impedance of  $\sqrt{36 \times 100} = 60$  ohms. Such a low value of impedance can best be constructed in the form of co-axial lines.

For air dielectric co-axial lines the surge impedance is:—

$$Z_0 = 138 \log_{10} \frac{D}{d} \dots \dots (8)$$

where D = inside diameter of outside conductor.

d = outside diameter of inside conductor.

A chart showing surge impedance of co-axial lines plotted against ratio D/d is given to save the above calculations.

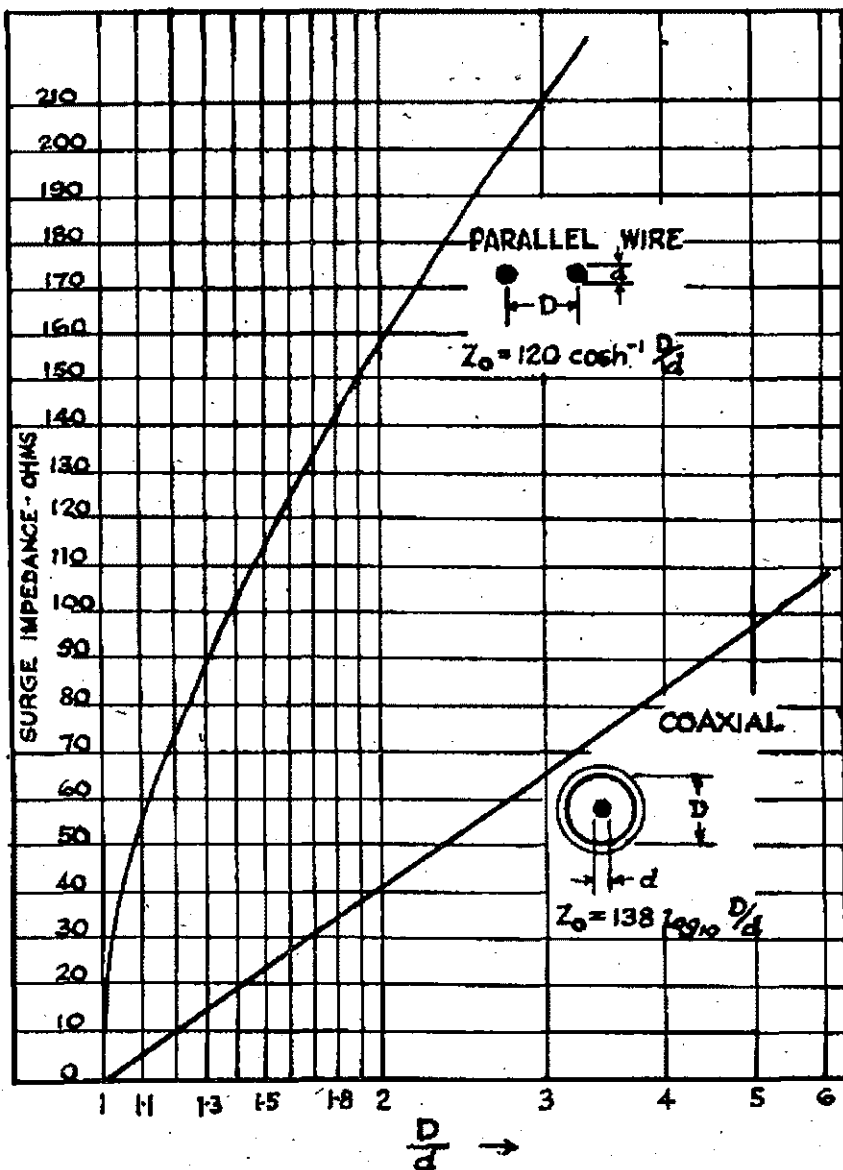

## SPECIALS! WHILE THEY LAST

0—5 Amp. Thermo  
Ammeters, 17/6

### METER SCALES

Suitable for Pullin "Disposal" meters. Volt-M.A.-Ohm or special Multi-meter scale.

Either type, 2/-, post free.

### POWER TRANSFORMERS

Wound on extra large core. Any voltage or amperage—Reasonably priced.

7-DAY DELIVERY SERVICE

Multi-Match modulation Transformers. 75-watt. In die-cast metal clamps.

Write for full details. £4/19/6. DELIVERY EX STOCK.

### CHASSIS — RACKS — PANELS

Any size, any gauge. Write enclosing full particulars.

Quotation forwarded by return mail.

VK3NU

## Major Radio & Electrical Co.

189 GLENFERRIE ROAD,  
MALVERN  
WM 1814 U 9354

### PHILIPS' MANUAL OF RADIO PRACTICE FOR SERVICEMEN

This book is written in a style that should appeal to servicemen and radio experimenter alike. It covers in general terms most aspects of radio communication; and includes some very useful formulae and tables. The contents were compiled by E. G. Beard, M.I.R.E. (Aust.) and are based on thirty-five years' practical experience. The manual caters for all standards of education, and fills the gap between highly technical and popular types of literature.

# DX BOOK-KEEPING

By W. T. S. MITCHELL,\* VK3UM

## 1.—INTRODUCTION

Whilst most of the pre-war school of DXers have by now adopted some means of logging and keeping a record of DX contacts, the newcomer to the illustrious ranks of DXers is perhaps doubtful of the best method to adopt. This article is here presented for their guidance. If the full methods explained are not used, it is hoped that at least some worthwhile ideas on this subject may be obtained.

## 2.—THE STATION LOG

**Brief Description.**—Although this section may seem superfluous in view of the fact that A.R.R.L. Log Books are readily obtainable, and that all Amateur Stations are required by Regulation to possess a log, it is intended here to outline a log book which more nearly fulfills the ideal. The individual can modify printed log books, in most cases, to this form.

It must be emphasised that every transmission that emanates from an Experimental Amateur Station should be logged, especially if one operates exclusively on the V.H.F. Adoption of this practice initially may save you many unnecessary headaches later.

**Form.**—For those who intend to either modify their present log book or make up one of their own, the following columns should be used. Column widths are dependent on the size of the log book and the requirements of the entry. Columns required are:—

- (1) QSO Number.
- (2) Time.
- (3) Station called.
- (4) Called by.
- (5) Report given (three small columns for R.S.T.).
- (6) Frequency or Band.
- (7) Receiver Dial Setting.
- (8) QTH.
- (9) Report received (similar to 5 above).
- (10) Time QSO ended.
- (11) Remarks (name of operator, etc.).
- (12) QSLs (two small columns for QSL sent and received).

The back of the sheet (or the left hand page when the log is opened out flat) requires only two columns:—

- (1) Time (small column).

- (2) Experimental changes (in equipment, circuits, adjustments to transmitter or the antenna, or other experimental work—large column occupying remainder of the page).

**Entries.**—The entries to be made are mainly self-explanatory, although several points in this connection may be made.

(1) Date.—This may be entered with pen or date stamp at the left side of page and nothing else should appear on this line. If any experimental changes, etc., are made the date should also be entered (where possible) on the left hand page opposite the same date on the log page, and any relevant entries made thereunder.

(2) Time.—May be either G.M.T. or standard local.

(3) QSLs.—In these columns, a "tick" is generally used when QSL card is sent or received.

**General.**—It is important to note that in regard to Log Books, all pages should be consecutively numbered. The consecutive numbering should continue on into each additional Station Log. The reason for this point is amplified and explained in the subsequent sections.

## 3.—THE STATIONS WORKED RECORD

**Description.**—This log book is complementary to the Station Log and is especially useful to the ardent DXer. In it is kept a record of all stations contacted.

The best type of book to use is a loose leaf type with an alphabetical index included for easy reference. A book with a stiff cover and 4-hole spring binding is to be preferred, as extra sheets may have to be added from time to time.

Pages are inserted after each letter of the index, and will contain all country prefixes that commence with that letter. For example, under the letter "H" would appear HA, HB, HC, HE, HH, HI, etc., in that order. Stations are then entered according to their call prefix.

A miscellaneous page may be inserted after "M" to allow for countries that have no prefix allotted. Suggested index letters are:—A, C, D, E, F, G, H, I, J, K, L, M, O, P, S, T, U, V, VK, W, X, Y, Z and ZL.

**Form.**—Generally, each page is ruled into three main columns, front and back of the page, after allowing sufficient binding space at the left or right. This has been varied in the writer's case for VK, W and ZL. VK and ZL are divided into only two main columns. The W sheet or its

counterpart will be discussed in the next section.

The three main columns are subdivided into smaller columns as follows:—

- (1) Station Call.
- (2) Bands.
- (3) Remarks.

(1) Station Call.—Should be made only of width to allow for the largest call likely to be encountered, e.g. UI8KFQ.

(2) Bands.—This column occupies most of the space and is divided again into 4 to 6 small columns about  $\frac{1}{4}$ " wide. Allowance is made here for the main DX bands, i.e. 7, 14, 21 and 28 Mcs. In the case of VK and ZL sheets, all bands may be included, i.e. 3.5, 7, 14, 21, 27, 28, 50 and 166 Mcs., as only two main columns occupy the full page width.

(3) Remarks.—Width only to take a few pertinent points about the station contacted and operator's name.

The main columns on each page are given a prefix and corresponding country heading. The three main columns on one page might be headed:—HA-Hungary, HB-Switzerland, HC-Ecuador.

If more stations are expected to be worked than there are lines in any one main column, two or even the three main columns may be allotted to one prefix. The English prefixes for instance, G2, G3, etc., are each allotted three main columns, or one full page each.

### Entries.—

- (1) Under "Station Call," enter call of station contacted.
- (2) Under "Bands," enter page of Station Log under the appropriate band on which the station is worked.
- (3) Under "Remarks," enter operator's name.

For example, G6CL may have been QSOed on 14 Mc. and logged on page 115 of Station Log. The entry in the Stations Worked Record would then be:—

G6CL under "Station Call."

115 under "Bands—14 Mc."

John under "Remarks."

G6CL may subsequently be QSOed on 7 and 28 Mc., when the page of the Station Log would be entered opposite station and under the appropriate band.

**Note.**—The log page is used as a reference in preference to the number of the QSO, as the Station Log page numbers would take some considerable time to exceed three figure numbers, with consequent ease of entry in the space provided.

As a check on QSLs from individual stations, a tick or underline can be made against log page entry opposite the station.

This log book will be found to be invaluable for quick reference, when in QSO, to find whether station has been contacted previously. The alphabetical index makes this simple.

\*1946 Malvern Road, East Malvern, S.E.5.

#### 4.—THE U.S.A. STATIONS WORKED RECORD

Facetiously, it might be said that this log was designed for the unwary newcomer to DXing, who calls CQ DX and invariably raises a W! Whilst this may be partly true, QSOs with W stations are inevitable and because of their numbers and lengthy call-signs, are difficult to keep a check of by the previously described method. It may therefore become necessary to keep a separate log of W stations. The W page in the Stations Worked Record is then replaced by this one. If it is decided to use the previous method, this log may be dispensed with.

**Description.**—This log is somewhat similar to that in section 3, but has a complete alphabetical index from A to Z. It has, in the initial layout, only 26 pages, one for each letter. These letters of the index represent the first letter of the call sign after the numeral.

**Form.**—Each page is ruled into 5 main columns, both front and back, after allowing sufficient binding space at the left or right. The main columns are subdivided so:—

- (1) Station Call.—Column wide enough only to take two letters.
- (2) Bands.—Divided into main DX bands as for Stations Worked Record, but necessarily smaller.

(3) State.—Narrow column to take abbreviated state name, i.e. Rhode Island, R.I.

(4) Name.—Column for operator's name.

The main columns, front and back of the page, are headed for a page inserted under Index "H," so:—

Front of page—

W1H W2H W3H W4H W5H

Back of Page—

W6H W7H W8H W9H W0H.

Extra pages may be added when a column is filled up, or when the new prefix "K" comes into use.

Entries.—

- (1) Under "Station Call," enter second, or second and third letters of call after the numeral.
- (2) Under "Bands," enter page of the Station Log under appropriate frequency band.
- (3) Under "State," enter abbreviated letter or letters.
- (4) Under "Name," enter operator's name.

For example, W4MS, in Florida, was contacted on 28 Mc. on page 87 of Station Log. Under page "M" and column "W4," enter:—

S under "Station Call."

87 under "Band-28 Mc."

F under "State."

Ed under "Name."

Or, WIBUX, in Massachusetts, who was QSOed on 14 Mc. on page 93

of Station Log. Under page "B" and column "W1," enter:—

UX under "Station Call."

93 under "Band-14 Mc."

M under "State."

Doug under "Name."

QSLs received may be marked as for Stations Worked Record. With this log, speedy reference may be made to a station even while in QSO.

#### 5.—THE DX COUNTRIES RECORD

This log is a refinement that may be added to your system if desired. It lists therein, countries QSOed, on what bands, and how many have QSLed. World Zone records are also kept account of.

**Description.**—This log is a similar type to the U.S.A. Stations Worked Record, being again a loose leaf spring clip binding with alphabetical index. One sheet only is required for each index letter.

**Form.**—Each page, under its index letter, consists (in order) of Countries as listed by the A.R.R.L. DX Century Club (February, 1947). All countries commencing with A are listed in order on page A, those with B on page B, and so on. The page is divided into columns as follows:—

- (1) Country.
- (2) Prefix.
- (3) Zone.
- (4) Bands.—This will be again divided into smaller columns to include 3.5, 7, 14, 21, 27, 28, 50 Mc. and Total.

Continued on Page 24

# ★ AMATEURS!

## Build Your Own Radios

### AFTER STOCKTAKING CLEARANCE

No. 11 Trans Receivers, Less Valves, at Bargain Prices	...	...	...	79/6
No. 19 " " " "	"	"	"	65/-
No. 101 " " " "	"	"	"	95/-
Gene Motors, input 11 Volts D.C., 175 Volts output or 500 Volts output...				49/6

### ★ South of the Yarra Hams

Keep on the Beam by making our Prahran Store your Headquarters.

Contact VK3FR (Fred Smith)

### "KINGSLEY"

KFT3 Kingsley Ferrotune 4-Valve Kit Set. Complete with Cabinet, £16/3/- Retail

### "TAYLOR" VALVES

U.S.A. TRANSMITTING TYPES

Type No. TZ40, T21-T55, TZ20, T125

Type No. 866J are now in Stock. Write to Veall's, Victorian Distributors, for further particulars.

# VEALLS

*Mail Orders* 243 SWANSTON ST., MELBOURNE Telephone  
 BOX 22417 299 CHAPEL ST., PRAHRAN R33145

## FEDERAL NOTES

The Rules of the DX Century Club have been approved and will be published in the forthcoming issue of "Amateur Radio." All DX contacts made since the return of licenses will be eligible for inclusion.

Federal Executive is considering the entries submitted for the design of a membership certificate and its decision will be announced shortly.

The Rules of the VK-ZL Contest to be held during the four week-ends in October next, have been completed and have been transmitted overseas for publication. Phone and c.w. participants will each be allotted two week-ends.

As directed by the last Convention, consideration is being given to the rules, etc., for an annual Interstate Contest to perpetuate the names of Amateurs who lost their lives during World War II. Suggestions as to an appropriate name for such a contest will be appreciated by Federal Executive.

Application has been made to the P.M.G.'s Department for a license for the Official Station of the Federal Council. Schedules will be announced later. It is understood that the call sign will be VK3WIA.

A sum which is estimated to cover six month's operation of the Federal QSL Bureau was passed for payment.

The manufacturers have advised that delivery of badges will be effected not later than the 2nd week in July, 1947. IF no industrial troubles are encountered.

### NEWS FLASH!

Official Bulletin No. 91, from the A.R.R.L. Headquarters, West Hartford, Conn., 2nd June, 1947, to all Radio Amateurs:—

Allocation studies are now in full swing at Atlantic City in a sub-committee considering 3 to 25 Mc. Matters are progressing normally with no more than the expected difficulties. The Amateur position is strong and is supported by numerous Countries, all the Americas particularly holding a solid front. In respect of the 7 Mc. band the United States has told the Committee quite plainly that it can never give up a single Kilocycle. The new 21 Mc. band is taking satisfactory initial form. Some weeks must elapse before definite allocation pattern is visible. A satisfactory definition of the Amateur Service has been adopted by an Atlantic City sub-committee defining it as a Service of Self-training, intercommunication and technical investigations carried on by Amateurs.

## FEDERAL QSL BUREAU

RAY JONES, VK3RJ, MANAGER

The first post-war cards from Rumania have recently arrived. This batch from YR5X, Box 326, Bucharest, has been anxiously awaited by a couple of DX C.C. aspirants.

VU2CW, "Tony" Timme, of G.H.Q. Signals, New Delhi, India, advises that from middle of May, the station will close and he will return to his home QTH in England. Desires all outstanding wallpaper to be sent via R.S.G.B.

The following QTHs may be of interest:—

EK1AA, A. K. Deviney, c/o RCA Communications, British P.O. Box 57, Tangier.

16USA, U.S.A.R.S., Asmara, Eritrea. WOMCF/C1, Box 2497, Shanghai, China.

Louis White, W6WLY, heard to advantage on 28 Mc. c.w., was a member of the 2nd A.I.F. and underwent a radar school at Ingleburn, N.S.W. Louis, who is a seaman, hopes to visit VK shortly and recently sat for his ship operator's ticket. He has vivid recollections of the quality and strength of a certain amber fluid purveyed in VK and hopes to renew

## TECHNICAL BOOK & MAGAZINE CO.

297-299 SWANSTON STREET, MELBOURNE

(Opposite Old Melbourne Hospital)

Central 2041, Melbourne, C.I

We can arrange subscriptions to any of the following magazines:

### AMERICAN.

RADIO: . . . . .	25/- year	COMMUNICATIONS: . . . . .	24/- year
Q.S.T.: . . . . .	27/- "	RADIO NEWS: . . . . .	40/- "
C.Q.: . . . . .	25/- "	RADIO CRAFT: . . . . .	22/- "
SERVICE: . . . . .	24/- "	SCIENCE DIGEST: . . . . .	23/6 "
F.M. & TELEVISION: . . . . .	48/- "	PROCEEDINGS INST. OF RADIO ENGINEERS . . . . .	88/- "
ELECTRONICS: . . . . .	97/6 "	POPULAR SCIENCE: . . . . .	23/6 "
SPECIAL RATE FOR THREE YEARS: . . . . .	195/-	POPULAR MECHANICS: . . . . .	23/6 "

### ENGLISH AND AUSTRALIAN.

WIRELESS WORLD: . . . . .	25/- year	WIRELESS ENGINEER: . . . . .	42/- year
PRACTICAL WIRELESS: . . . . .	13/6 "	ELECTRONIC ENGINEERING: . . . . .	33/- "
AUST. RADIO WORLD: . . . . .	10/6 "	RADIO AND HOBBIES: . . . . .	6/6 "
AMATEUR RADIO: . . . . .	6/- "	SHORTWAVE MAGAZINE (English): . . . . .	25/6 "

FOREMOST IN AUSTRALIA FOR TECHNICAL BOOKS.



his acquaintance with the above substance soon after reaching Australia.

"Stinky" Green, ex-TG9FG, is a clipper pilot and is now back in the U.S.A. flying on home routes. TG9JK from whom this information comes, stated that his station is the sole remaining TG on c.w. This is not correct, however, as writer heard TG9BA on 28 Mc. c.w. a few moments after concluding the contact with TG9JK.

The recently licensed Canal Zone bunch—about 60 licenses have been issued so far—are very active on 28 Mc. and put good c.w. signals into VK. They can be heard working Li2B—the raft Kon Tiki on schedule most any day. Most prominent among the bunch are Ollie, Tommy and Kim.

Gene, W4JQT/MM aboard the vessel National Victory, has been heard regularly from East African ports on 28 Mc. One day during late May Gene had a visitor aboard in the shape of Bill, W3WTQ, whose ship was anchored alongside the National Victory when at Port Elizabeth. Many VK Hams have made this interesting contact.

A keen philatelist soliciting VK contacts is Dr. Angel Mora, EA9AI, Canalejas 1, 1st Melilla, Spanish Morocco.

A complete list of the license holders in Holland has just come to hand from V.E.R.O.N., their national Society. The list, which shows that Amateur Radio is booming in the Netherlands, contains many well known pre-war call signs and names but alas a number of just as well known names are missing.

A brochure is to hand from a body styled The World Friendship Society of Radio Amateurs, Archers Court, Stonestile Lane, The Ridge, Hastings, Sussex, England. Its objects are to promote World Friendship per medium of Amateur Radio, to provide education and holiday facilities at home and abroad, to maintain a social and technical service, journals and QSL bureau, language services, library, laboratories and other facilities. Membership is open to everyone who is interested in Amateur Radio, and the annual subscription is 7/6 (English).

An interesting brace of cards are to hand from D4TAO (pre-war) confirming a contact in 1939 with VK2TF. Accompanying it is another card from DEM1829 to which status D4TAO has now been reduced, giving VK2TF a listener's report and stating it was impossible to forward earlier the card relating to the pre-war contact.

An interesting visitor turned up in Melbourne early in June in the shape of Jim Wetherell, G5UB/P. Jim also has a Canadian call sign. His ship has now left for Sydney at which port he expects to remain for some weeks (wharf laborers permitting). Jim desires all wallpaper relating to past and future contacts to be sent to his home address: 4 Park Villas, Wetherby, Yorkshire, England.

Remember a par in February "A.R." relative to the claim of PK6HA that VKs were treating him badly in the shape of QSLs? Well gents the par bore fruit thanks, as the following letter from PK6HA testifies:—

"I hurry to write you to thank you for helping me to get the QSLs. Just today (15/5/47) I received the February issue of "A.R." and noticed the par in the QSL notes. I am glad to be able to tell you that I think the VKs still are good sports, perhaps only a bit slow because after the par appeared I received two letters, also today, containing a lot of QSLs."

An interesting journal in mimeograph form is to hand from the F.E. A.R.L. and is the official journal of the Far East Amateur Radio League. Many interesting items of local interest are included and many worth recounting if space permitted.

## What You have been waiting for TAILOR TRANSMITTING TUBES

Very Low Driving Power Required.

T20 TRIODE, 42 watts output, Class C .. .. .	£2	2	6
T40 TRIODE, 150 watts output, Class C .. .. .	£2	18	6
T55 TRIODE, 168 watts output, Class C .. .. .	£4	0	0
TB35 TETRODE, 130 watts output, Class C, to 250 M.C. half power to 400 M.C. ..	£6	10	0
TZ20 ZERO BIAS MODULATOR .. .. .	£2	2	6
866 JUNIOR RECTIFIERS .. .. .	£1	4	0



Full data forwarded on request.

Crystals as illustrated. 40 or 80 metre AT or BT cut.  
Accuracy 02% of your specified frequency, £2/12/6.  
20 Metre Zero Drift £5/0/0

Large unmounted 80 or 40 metre, zero drift, £2.

Crystals Reground, £1 each.

Filament Power and Modulation Transformers made to order. Reasonable Prices  
Prompt Deliveries.

T.C.C. 1.5 MFD. 5000 volt Working Condensers .. .. .	£2	5	0
EIMAC 35T TUBES .. .. .	Each	£3	8 6

**BRIGHT STAR RADIO VK3UH** Late R.A.N.  
1839 LOWER MALVERN RD., GLEN IRIS, S.E.6., Victoria.  
Phone: UL 5510

WHERE EXTREMELY HIGH ACCURACY IS DEMANDED

FIFTY AND UP

FLASH—50 Mc. OPENS AGAIN

On Sunday, 22nd June, in the middle of a most satisfactory field day in VK3 the 50 Mc. band opened from 1500 hours to 1630 hours and VK4PG in Bundaberg was worked by 3GG, 3HT, 3ED, 3BW, 3RZ, 3CP and later 3DA. 4PG also heard 3BD and 3BD heard 4PG but no contact was made. 4PG also worked 3ZL and 3WD in Ballarat.

Signals were fair to good with QSB mostly both ends but not as good as in December last. It is a great pity that there were not more VK4 stations on. If there were more general activity on 50 Mc. it is almost certain there would be more DX contacts made.

VICTORIA

The V.H.F. Group held the usual monthly meeting on the Wednesday following the general meeting. Good attendance of Hams and visitors attended. VK3YS did a good job as Chairman.

Arrangements for field day were finalised and publicity on other bands arranged for. 3LS displayed some of his 166 Mc. gear, a p.p. CV6 linear oscillator with parallel lines in cathode and plate circuits. Reg explained circuit of same, together with power output, frequency stability, etc. This was his portable rig and was well made. He uses a pair of 834s with 20 watts input in same circuit, at home, on 166 Mc.

3NW displayed a "Hi C" 166 Mc. oscillator coupled to a 832 p.p. final. Oscillator included a DET<sub>3</sub> (7193-CV6) with a one turn  $\frac{1}{8}$ " diameter copper tube 2" diameter as inductance tuned with 50 pfd. variable condenser; 832 p.p. final used all "poly" insulation and silver wire for coils, etc., and copper chassis; construction was very neat and compact.

After meeting closed general discussion followed and several Hams present wanted "dope" on how best to go on 50 Mc.

Band was rather quiet in June. Stations active include 3BD, 3CP, 3MJ, 3BQ, 3HK, 3YS, 3EH, 3HT, 3XA, 3ABA, 3QR, 3GG, 3DA, 3QZ, 3AN, 3HZ (Warrigul), 3BW (Port-arlington). Also sundry 7 Mc. harmonics and key clicks (3JP especially). Also one or two vicibus super-regens.

VK3BD worked a station signing LU2CP on Saturday, 2/6/47, at 1615. After several overs, with 3BD on i.c.w. and LU2CP on phone, stations managed to exchange call signs and signal strengths. Signals were S1-5 and as LU2CP was not speaking English, the going was tough. Subsequently a letter from the Radio Club Argentino stated: "With respect to above we are pleased to advise that

**IRC**

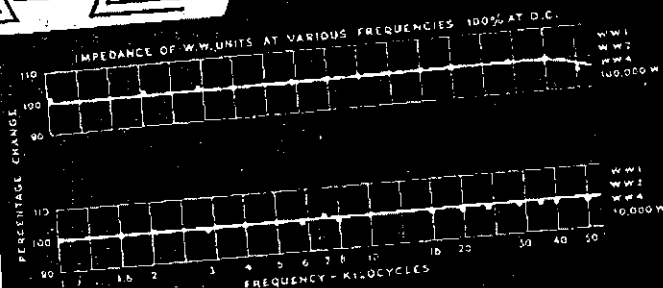

**PRECISION WIRE WOUND RESISTORS**

Available in all Resistance Values up to:



WW2 to 1.3 meg.

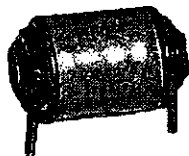

WW5 to 750,000 ohms.

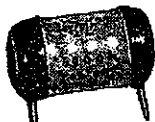

WW4 to 350,000 ohms.



WW3 to 125,000 ohms.

They have been developed to meet the exacting demand called for in Talkie Equipment, Multipliers and Shunts for Meters, Attenuation Controls, and all applications where low temperature co-efficient, stability and a high degree of accuracy are essential.

Because of the special sectional construction and impregnation, which permit the winding of adjacent sections in opposite directions, a non-inductive winding of low distributed capacity is made possible. The impedance characteristics of these units are practically uniform and independent of frequency up to 50,000 cycles, as shown in graph above.

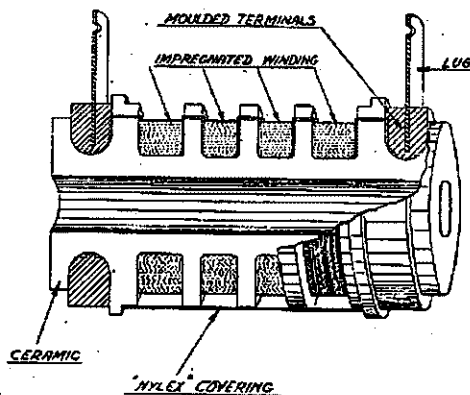

Sectional view of Type WW.

Sole Agents for Australia

(Note new Telephone Number)

**Wm. J. McLELLAN & CO.**

BRADBURY HOUSE, 55 YORK ST., SYDNEY • PHONE BX2508

**LU2CP does not exist in this country, and further that the call is unknown in the Argentina."**

The writer of these notes has heard several signals on the 50 Mc. band with QSB on them recently, during the day time. Only modulation has mostly been "hello test, hello test," whistling, etc., and, most exasperatingly, never a call sign. Would it be asking too much for stations testing to say (example) "VK 3XYZ testing on 50 Mc." instead of "hello test, 1-2-3-4-5-6-7," etc. DX conditions do not as a rule last long on 50 Mc. and you don't know how far you may be "getting out."

Listening on the 50 Mc. band one often hears a station come on and call CQ once or perhaps twice and disappears; a short time later another station comes on and calls CQ in turn and disappears; this may go on all the evening. It has been suggested that if stations made it a rule to call "on the hour" or half hour, more contacts may be made. Running tone for say five minutes before calling CQ does no harm either. "It is easier to find a needle if it has a long thread on it."

Stations active on 166 Mc. include the following (by courtesy of 3MJ who has a 15 tube receiver working on that frequency):—3MB, 3NB, 3NW, 3YS, 3MJ, 3LS, 3OF, 3ACM, 3XA and 3XM.

### QUEENSLAND

Most of the locals are suffering from that well-known malady "beam fever," and arrays of various sorts are sprouting on all sides. The first victim in the present scourge seems to have been 4PG in Burdaberg, who came to light with a 4 element horizontal. Arthur has arranged skeds with Brisbane in an effort to break through, the times of transmission being 2000 and 2010 hours, the signal being m.c.w. and on for five minutes at each of the above times with a listening period at the end of each transmission. The frequency is 52 Mc.

4FB and 4RY have constructed 2 element rotaries, while 4ZU has one on the drawing board. Funny thing, there's that much thought gone into the thing that it's now possible to light a neon bulb by touching the base of the board. 4KB has fitted an S meter to his super and the lads have lost no time in getting checks off Pat with little details such as front to back ratio, etc.

Queensland's Secretary (4RT) has made his debut on the band, and as the result of some 20 odd DR106s finding new owners we are permitting ourselves the luxury of thinking that there will soon be a few more operating on 50 Mc. 4ES and 4XG found the job of conversion fairly easy, and Herb was also heard to remark that they didn't seem to be too heavy on batteries.

Paying a brief visit to Brisbane, 4LP (alias 2YQ) found that a healthy

## MONTH'S DX

### WESTERN AUSTRALIA

28 Mc. Phone, Europe.—Very spasmodic this month but when band has been open it has produced a good choice. Gs 8SY, 2BMZ, 2CDI, 8FH, 5OV and 3WH from the old country, and from the Continent HB9CV, F8TY, OIX7, and PA0FB were good QSOs. As the winter draws on it is expected that this Continent will be heard even less from 1600-2000 hours.

Africa.—Conditions, this month, have favoured this continent very well and some excellent QSOs have resulted. ZSs 6IG, 6EB, 6EK, 1AX, 6JB and 5DA were worked with S8 signals or over and these boys from the Union have had a rare time working ZLs the same way as we in VK6 try to work South America. From the northern half of Africa VQ2PL, VQ3EDD and VQ4TDB have provided good contacts. Times have been from 1300-2000 daily.

North America.—Ws and VEs on this band are becoming rare DX during the morning, but a few east coast contacts have been made around 1900 the long way around across South Africa. Conditions this way have been very spasmodic.

Central America.—A few of these elusive birds have put in an appearance during the mornings, but the only contact made was XE1KE.

South America.—Some of these boys are being heard quite regularly these days, but it's a different story trying to get in ahead of the ZLs and VK3s. However, CE1AH was worked by VK6KW a few Sundays ago at 1000 while HK4FX has had the strongest signal in VK6 for some time.

Asia.—All usual VS1, VS2, J and C boys still about, and it's interesting to note that Hong Kong has now relicensed its amateurs a few months ago. VS6AM was worked the other Sunday and the contact proved most interesting.

Oceania.—VK (east side), ZL, KH6, KA and PK pound through with the

programme of antenna adjustment had been arranged for him but Les rose to the occasion like a true VK4. Up in Ipswich 4AB has succeeded in pushing a signal into Brisbane but hasn't been able to hear the locals. The whole thing was strangled at birth by Ramsay's temporary absence from home, which was a little disconcerting, but we hope to resume again shortly.

4ZU has built his rig up into rack and panel, and added a new 28 Mc. transmitter. 4HR is sporting a new microphone and as a result now has "broadcast quality." 4ZU is getting writer's cramp and is closing down.

advent of winter during daylight hours and may be worked easily.

14 Mc. Phone, Europe.—As winter draws on this continent is proving more elusive from 2300-0300 but during the afternoons from 1400-1700 quite a few put in excellent signals the long way round across the Pacific. ON4PW, G5CI and F8NT were worked the long way, while fair QSOs resulted with LILV, G8AC, and G5DQ the short way across India.

Africa.—Activity from here has also fallen off lately and is not as consistent as past month's notes have shown. The few QSOs which resulted have been good on the rare occasions the band opened. ZS2X, ZS5M, ZS2CI and ZE2JD filled in a few hours between 2000-2300.

North America.—A few "punk" evenings with this continent, but generally speaking it's been wide open from 1600-2200. Ws worked are too numerous to mention but amongst the Canadians were VEs 4RF, 3AGB, 4QV, 3HC, 7AAD, 3AIU and 4RP who were all worked S8 and over both ways.

Central America.—These QSOs are becoming more frequent lately as XE1FB, XE2HY, XE1LE, VP9F and CO7CX were worked with good signals from the South East from 1900-2100.

Asia.—A good variety of VU, VS, J, etc., to choose from, although contacts this month have not been frequent as conditions have to be very poor from other directions for the writer to turn his beam.

Oceania.—Some good contacts from the South Pacific have been made, the best being W6WDN/KW6, J9LG and KH6KK. It's interesting to note that a few ZLs have turned up again in the W phone band after no activity for three months or so.

News from the Danish Amateur Society, E.D.R., states that their summer camp will be held this year at Funen and a large number of visitors from abroad are expected. This camp is an annual event and a transmitter is invariably installed on the main bands. The camp will cover the period July 6 to 13 inclusive. The frequency allocations to the Danish Hams and their compulsory division is of great interest to VK where a similar division could well be instituted. Phone frequencies are shown in brackets: 3.5-3.565, 3.685-3.8 (3.69-3.795), 7-7.2 (nil), 14-14.4 (14.1-14.25), 28-30 (28.5-29.7), 58.5-60 (58.7-59.7) Mcs.

\* \* \* \*

J2AHI ordered a batch of QSL cards from a Jap printer and on the card included the statement "on the air since 1929." The printer in his wisdom amended this to read "no air since 1629." What do the Japs use to fill their lungs.

## STATION DESCRIPTION

# VK4XG

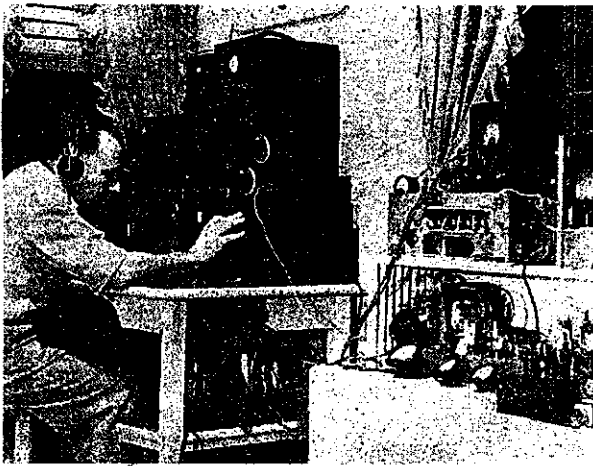

Old-timers may remember Gordon Augustensen better as holder of the pre-war call VK4JN of Mitchelton, Brisbane. VK4XG now operates mostly on 50 Mc., but puts in occasional appearances on 7 and 28 Mc., having separate transmitters for each band.

On the left of the operating table is the 7 Mc. Transmitter, with a signal generator sitting on top. Above the H.R.O. is an eight tube 50 Mc. super (XG's prize baby), with a C.R.O. reposing on top of this last unit for the dual purpose of keeping an eye on modulation, etc., and also to prevent the locals making the receiver dance about. On the right of the picture the 50 Mc. Transmitter is on the top shelf with another C.R.O. visible on the extreme right. Below all this sits a 100 watt 28 Mc. rig with 829 p.a., the unit on the right being a bias supply. Modulator and power supplies are just visible under the operating table. Antennas include a folded dipole for 50 Mc. and a half-wave vertical on the 28 Mc. band.

Dealing with personal angle, 4XG's interest in Radio is not confined to Hamdom, as he is associated with a well-known radio firm in Brisbane. Not so long married, he still finds time to keep the 50 Mc. band warm and indeed is one of the stalwarts of that band. "Gus," as he is more familiarly known to VK4s, served with a radar unit during the war and perhaps this fact is responsible for the change from a pre-war low frequency man to a post-war high frequency Ham.—4ZU.

## Such Nice People

By "GREMLIN"

To the Hams who expressed their appreciation through the May issue, I say thanks, but I'm not too certain about this "blue orchid" stuff. I guess the VK6 gang reckon I'm a pretty vile weed far removed from that noble bloom. MY, OH MY, VK6s your remarks re commercialism make me think—a painful process! What's more I think you might be right. There is much to be said on both sides.

Thanks also to the VK5 who posted me a free copy of a local Radio Club's mag. Sorry o.m., I haven't heard of your Club, probably because I'm a dyed in the wool W.I.A. bloke. As a matter of fact you might call me "W.I.A. Gremlin" and as such my thoughts gush. As 6MU might say on the old adage basis "united we stand, divided we fall." So let's grasp mits across the sandy waste and dig for Amateur Radio, OK?

Heard 3DQ again with a rough note, complete with clicks, chirps and backwave. 2EL told him and then stood by with the helping hand. Nice work Doug and Stan, that's how it should be—the co-operation angle I mean. Have heard you since Doug, with a T9 note so all is well:

3BP your note is worse than ever. To your roughness and chirps has

been added a considerable frequency drift plus a parasitic up the other end of band. About 1945, 12th June, 7 Mc., fundamental low end, parasitic high end, when the foul deed was committed—if it's any help. Say o.m. I'm on your back aren't I? Three mentions in two months is almost worth a "gong."

To the fore with clicks early in the month—2ALG, 5JS, 2BK, 2DO and 2PA.

Heard a chap on 14 Mc. complaining about harmonics from 3MS and 3IW working on 7 Mc. Apparently had been calling his head off without much success. I couldn't hear them, possibly because of distance, but I pass it on for your benefit.

3TO, you have a rather hefty parasitic on approximately 4500 Kc. Better have a look before the axe falls.

4CK's note would qualify for the suggested "abrasive" section.

Pleased to hear 3WI sponsoring an open season on "pirates." Undoubtedly a lot of the poor sigs and punk operating emanates from these para-

sites and we owe it to ourselves to assist in ridding the air of them. Wish I could catch up with the user of my call—have been after a modulation trannie for a long time.

Incidentally, 3WI's phone is a big improvement but I gather harmonics are still occupying the thoughts of George. One way of spreading the news!

Splashers all—3OG, 5CR, 2ALE, 3FU, 5CH, 3IK and 3AO.

3RW has turned to phone. Must be after my disparaging remarks on his c.w. You have a pretty solid hum there Reg, so I guess it's the same old r.f. generator. Boy how you must hate me.

2AMZ also has a bad hum present.

3AIR, your phone is pretty poor quality stuff.

3YL joins in with clicks. Wasn't always there.

Before I pull the switch for this month I must thank 6MU. You know o.m., you are the first chap I've struck who even considered for one moment I'm wise. Keep this chappie in mind Editor, he wields a mighty slick crayon and may be good for a few lines for "Amateur Radio" one day.

WHEN YOUR SPARE PARTS COLLECTION DECREASES

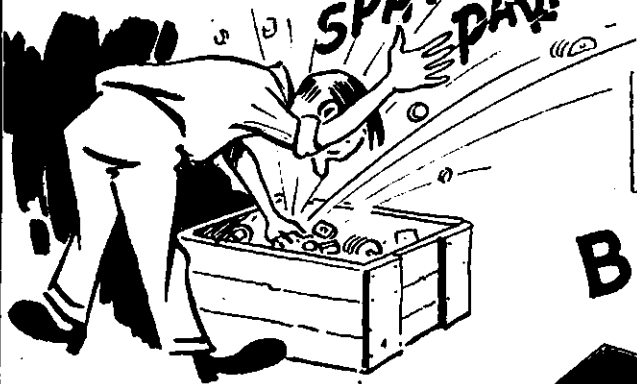

Replenish with  
**EDDYSTONE**  
BITS and P/ECES

**ALUMINIUM CHASSIS**

This Die-cast chassis provides a strong foundation for all kinds of small equipment, such as receivers, power packs, R.F. and A.F. amplifiers, etc. It measures 8½" by 5½" and is 2½" deep. Cot. No. 643 ..... 16/9

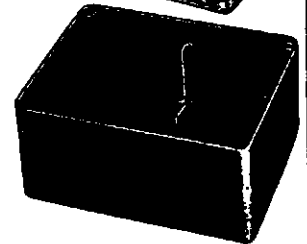
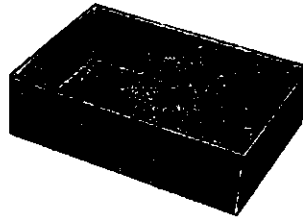

**I.F. TRANSFORMER**



This highly efficient 450/465 Kc/s. I.F. Transformer is wound with litz wire and is permeability tuned. The brass case, which measures 1½" x 2" x 2½" high (above chassis) provides very complete screening. The band width for a pair of transformers in a normal circuit is 5 Kc/s. at 20 dB down. Two stages (i.e. three transformers) result in a bandwidth of 5 Kc/s. at 30 dB down. Connections are brought out through ceramic bushes and mounting is by means of two 4BA tapped inserts in the base. Cot. No. 645 ..... 27/-

**DIE CAST BOX**

This small zinc alloy die-cast box measures internally 4½" long, 3½" wide and 2" deep. It is supplied complete with close fitting flange lid and will be found invaluable for many purposes, including wave meters, screened oscillator, screened pre-amplifier, etc.

Cot. No. 650 ..... 8/5

**MOULDED INSULATOR**



This moulded insulator will be found extremely useful as "Stand-off" Insulator, "Lead through" or "Terminal Post." It is supplied in two colours, red or black. Construction is such that neither the insulator portion nor the screw will revolve when wires are attached and tightened. It is made with reversible fittings so that it can be mounted above or "through" the chassis. Each insulator is provided with two 2BA nuts and shake proof washers. They are satisfactory for 1,000 volts working. 1½" high, 1½" between fixing screws.

Cot. No. 564 Red ..... 2/11  
Cot. No. 564 Black ..... 2/11

**LEAD-THROUGH INSULATOR**

This insulator is designed primarily for carrying high frequency leads through metal chassis with a minimum of loss. The insulator cones are of glazed Frequentite and are flanged at the bottom, to fit into the chassis. A.N.P. 4BA brass rod is used as the conductor. Lead washers are supplied to prevent breakage of the cones. Cones 1½" long, 1½" maximum diameter.

Cot. No. 1018 ..... 3/10

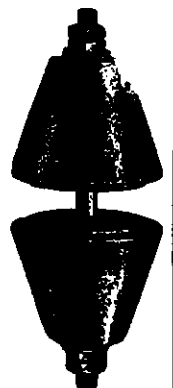

These and other bits and pieces are available from  
**Your Distributor**

- ★ VICTORIA: J. H. MAGRATH & CO.  
208 Little Lonsdale Street, Melbourne
- ★ N.S.W.: JOHN MARTIN PTY. LTD.,  
116-119 Clarence Street, Sydney.
- ★ QUEENSLAND: CHANDLERS PTY.  
LTD., Cnr. Albert and Charlotte Sts.,  
Brisbane.
- ★ WEST AUSTRALIA: CARLYLE & CO.  
Hay Street, Perth and 397 Hannan  
Street, Kalgoorlie.
- ★ STH. AUST.: GERARD & GOODMAN  
LTD., 192-196 Rundle St., Adelaide.
- ★ TASMANIA: W. & G. GENDERS PTY.  
LTD., 53 Cameron Street, Launceston.

Australian Factory Representatives:

**KEITH HARRIS & CO. PTY. LTD.**  
51 William St., Melb.  
Telephone: MB 2119.



## DIVISIONAL NOTES

### NEW SOUTH WALES

Secretary: Peter H. Adams, VK2JX  
Box 1734 G.P.O., Sydney.  
Meeting Place: Science House, Gloucester and Essex Streets.  
Meeting Night: Fourth Friday of each month.

The annual general meeting, adjourned from April, was held at Science House on 24th May, 1947, with the now customary attendance of well over 100 members. The Annual Report read to members by the President was well received and showed that considerable progress had been made in the Division's activities during the past 12 months particularly with regard to increase in membership. A copy of the Report and Balance Sheet is to be mailed to each member.

Following on the return of a record number of ballot papers, the under-mentioned officers were elected to Council, which at its first meeting, made the appointments as under:—

President: Mr. M. H. Meyers (2VN); Vice Presidents: Messrs. P. H. Adams (2JX), J. Moyle (2JU); Federal Councillor and QSL officer: Mr. J. B. Corbin (2YC); Membership Secretary: Mr. W. Dukes (2WD);

Social Officer: Mr. R. Anthony (2TR);  
Councillor: Mr. C. Hutcherson (2YP).

The undermentioned additional appointments have either been made or confirmed by the new Council:—

Treasurer: Mr. D. Reed (2DR);  
Delegates to Bushfires Advisory Committee: Messrs. Meyers (2VN), Moyle (2JU) and Treharne (2IQ); V.H.F. Officer: Mr. C. Fryar (2NP); War Service Census Officer: Mr. C. Hicks (2ADV).

It will be noted that at the time of writing a new Secretary has not yet been appointed, Mr. Adams continuing to act in that capacity.

During the counting of votes, the Federal Councillor (Mr. Corbin) gave members a brief resume of proceedings at the recent Federal Convention. It is obvious to all that during the next few months considerable attention must be paid to the future organisation of our Institute and to this end a sub-committee of Council has already been appointed to deal with matters affecting the adoption of a uniform constitution. It is felt by Council that the creation of a sub-committee to handle social activities under the guidance of a Councillor will fill a long standing requirement. Preparations are at present being made for the Annual Dinner which of necessity had previously to be deferred.

The attendance at meetings of the V.H.F. Section is rapidly increasing— at the Section's last meeting no less than 65 members and visitors were present. A most interesting lecture was delivered by Mr. Gil Miles on equipment used for the radio control of models. The lecture was illustrated with working sections of the equipment used on the epidiascope.

Although response has not quite reached expectations, several articles have been received as entries in the Division's monthly contest for technical material for "Amateur Radio." The prize for the month of May has been awarded Mr. Alf Barnes (2CE). The opportunity is again taken of pointing out to members that the magazine is in your hands and like any machine, one may only expect results commensurate with the work put into it. The monthly prize of £1/1/- allotted by the Division for the best technical article received for "Amateur Radio" is to continue for a further four months so set to it chaps and see if you can take out that prize.

All equipment, including crystals, made available from the Liquidations Commission has now been distributed and whilst many members had their wishes fulfilled in this respect, it is regretted that resort to allotment by ballot was found to be necessary in so many cases.

The advertisement features a detailed illustration of a rectangular transformer unit. On top of the unit, there are several vertical pins or terminals. A banner is draped across the front of the unit, with the text "ALL-ROUND EFFICIENCY" written on it. Below the banner, the word "TRIMAX" is printed in large, bold, block letters. To the right of the transformer, another banner curves upwards, containing the text "TRANSFORMERS". The transformer unit itself has some technical specifications printed on its side, including "TYPE 2U", "TA17", and "MELBOURNE AUSTRALIA".

Available in Line to Grid, Plate to Line, Interstage — Single and Push-Pull types, Trimax Transformers are constructed of the finest materials and feature high Permeability, Nickel Iron Alloy core—heat treated in our own factory for Optimum results.

Also for Amplifier enthusiasts  
... Standard or Custom built  
Chassis, Speaker Flares, Power  
Transformers, Microphone  
Stands, Filter Chokes, etc.

## TRIMAX TRANSFORMERS

(Division of Cliff & Bunting Pty. Ltd.)

29-35 FLEMINGTON RD., NORTH MELBOURNE

## NORTH COAST AND TABLE- LANDS ZONE

2ZX puts out a quality signal on 7 Mc., uses a vee beam with success. — 2LH recently gave a "get-together" for the district Hams, all enjoyed themselves; expects to have the new rig going shortly. — 2AGM often heard on 7 Mc. and he should have the beam on the tower by this. — 2NY has just completed a new modulator. — 2GI working plenty of ZLs on 3.5 Mc. and sometimes on 7 Mc. — 2SH consistent on 7 Mc. phone and c.w. — 2PA heard trying out his ATs, works some DX on 7 Mc. — 2AEY with an inductively coupled dipole on 7 Mc. — 2RK is QRL building a new rig, consistently on 7 Mc. phone. — 2CJ no-news, maybe fitting the gear in the new home. — 2AIH operating on 7 Mc. and busy revamping the big rig. Please send notes to 2AFP at South Sasno.

## COALFIELDS ZONE

2KZ on 28 Mc. again after being right off for a few weeks; toying with idea of 50 Mc. He reports a new Ham in Kuroi, no call sign yet. — 2YO heard on 14 Mc., talks of beam antenna but no details. — 2XT mostly on 7 Mc. phone, has lots of gear and should be active soon. — 2DG in his new home at Maitland but not heard on. — 2TY no news, give me a tingle some day. — 2PZ mainly on 7 Mc. fone. Hopes to have a nice noise limiter going soon. — 2LB has left Cessnock, back in the city.

2MK is active on 28 Mc. and revamping the receiver. — 2ADT still getting the rare ones on 28 Mc., latest is a QSO with Malta on 28 Mc. fone and confirmation the next day; yes, a cable from Malta a few hours after the QSO did the trick. Has 73 countries now up on 28 Mc. phone, 94 all told. He has been heard by 2BZ in Newcastle on 50 Mc. — 2YL QRL writing up card index system, mainly on 28, 27 and 14 Mc. phone and c.w. Cessnock boys had a visit from ZL4HS who was brought along by 2FP and 2AGD of Newcastle. Please send notes along to 2YL of Cessnock.

## WESTERN ZONE

2II has a new 14 Mc. rotary and judging from the stations that call him, it surely works. W.A.C. much trouble Max? — 2NS working on c.w. and is contemplating new 14 Mc. rotary. — 2OF has left Parkes for the bright lights, best of luck Jack. — 2EL, a new Ham at Narromine, has nice phone and c.w. on 7 Mc. — 2AMR very QRL rebuilding, has tried some disposals gear but says n.g. — 2ACU and 2DO journeyed to 2WH to try and get the AT20 going on some 14 Mc. DX, slight trouble, something

to do with oscillator. — 2BT still pounding out c.w. on 7 Mc. — 2DQ last heard of visiting VIS. — 2IE heard occasionally on 7 Mc. phone, just can't seem to get on permanently. — The Orange gang are still chasing DX on 28 and 14 Mc.

2TA and 2TC getting going on 50 Mc. Results have been i.b. we believe. — 2JC heard one night long ago. — 2ACT buying and selling. — 2QA pottering along on 28, 14, 7 and 3.5 Mc. phone with band switching xmitter (one switch). Working out system to change bands by voice control (beat that Max). Send your Zone notes to 2QA of Nyngan.

## SOUTHERN ZONE

2ANQ skiing around mountains instead of finishing rig. — 2APW like an Eskimo went south for his vacation, returned with new vigour. — 2VK hopes for contacts now that job has cut out, finds ripple with 6L6 instead of 6V6 c.o. — 2EU heard occasionally on 7 Mc. phone. — 2OJ returned from holiday with time available and is revamping xmitter and receiver. — 2GG working mostly on 14 Mc. c.w. also getting phone ready. More notes please chaps to 2OJ Albury.

## VICTORIA

Secretary: A. B. D. Evans, VK3VQ, Box 2611 W G.P.O., Melbourne.

Meeting Night: First Wednesday of each month.

Meeting Place: Radio School, Melbourne Technical College.

## "FOOD FOR R.S.G.B." APPEAL

Since this Appeal commenced on the 2nd April, 24 food parcels and two soap parcels have been despatched to the Secretary of the R.S.G.B. for distribution. This represents two cwts. of urgently-needed foodstuffs for our brother Amateurs in Britain. Another 24 food parcels will be on the way when this appears in print. The original objective of one cwt. (12 parcels) per month has already been exceeded.

The Committee gratefully acknowledge the following donations:—

£25 from the W.I.A. Victorian Division.

£7/14/6 from 3YV, North-East Zone Organiser, as result of Zone donations.

£2/10/6 from 3QC, South West Zone Organiser, as result of South-West Zone Convention collection.

Many thanks, fellows, and keep up the good work.

Organisers are still required in the North-West Zone, Eastern Zone and Western Zones. Any Amateurs in these Zones who would be willing to

# Low Drift Crystals

FOR  
**AMATEUR  
BANDS**

ACCURACY 0.02% of  
STATED FREQUENCY

3.5 M/C and 7 M/C

Unmounted .. £2 0 0

Mounted .. £2 10 0

12.5 and 14 M/C Funda-  
mental Crystals, "Low  
Drift" Mounted only £5.

Spot Frequency Crystals  
Prices on Application

Regrinds . . . £1 0 0

THESE PRICES DO NOT  
INCLUDE SALES TAX.

## Maxwell Howden

VK3BQ

15 CLAREMONT CRES.,  
CANTERBURY, E.7.

act in this capacity, should notify VK3UM, the Appeal Secretary, without delay.

In order to officially conduct raffles of radio gear (which has been kindly donated), the Committee were required to apply for registration as a Patriotic Fund. They are now pleased to announce that approval has been granted, and the official designation of the Appeal is now the "Wireless Institute of Australia Food for Britain Patriotic Fund." The metropolitan Committee (VKs 3UM, 3UH and

# Concentration

Under the guidance of skilled hands, Australia's requirements of radio valves daily take shape at the Ashfield (N.S.W.) Works of Amalgamated Wireless Valve Company Pty. Limited.

Defiant fingers and delicate machines ensure efficient construction whilst critical eyes constantly scrutinize each progressive step in their assembly.

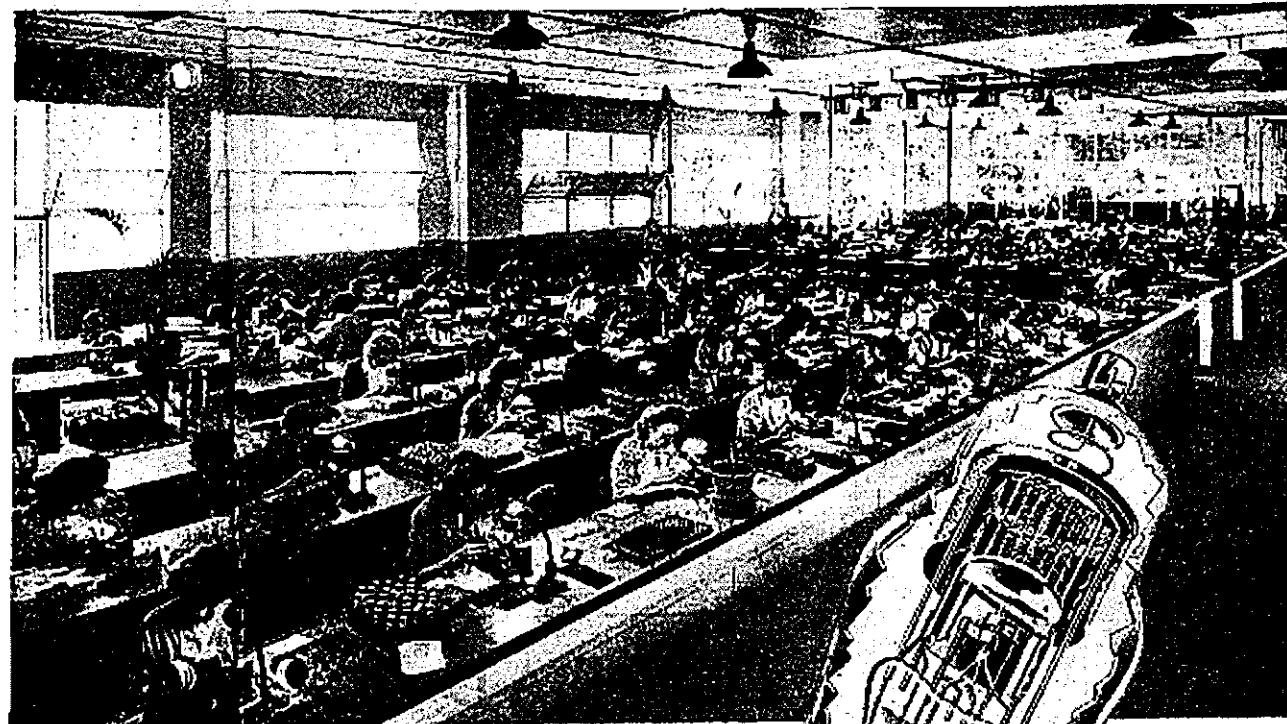
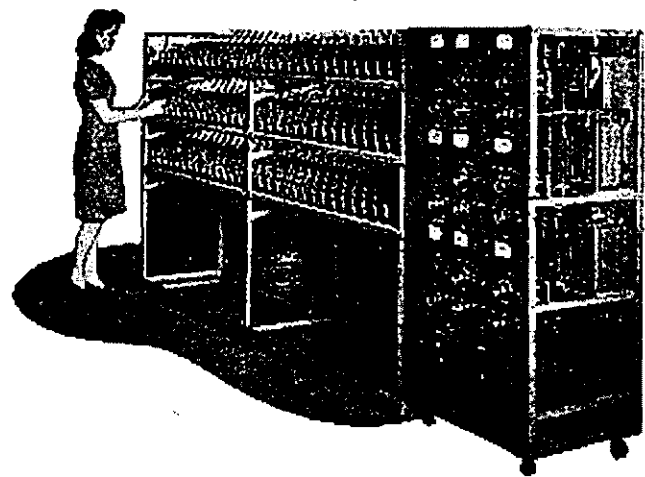

Assembling Australian-made receiving valves at the works of Amalgamated Wireless Valve Company, Ashfield.

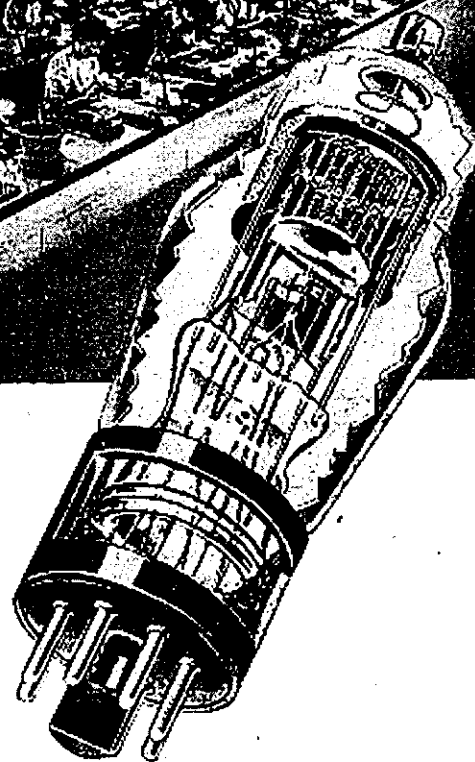

AMALGAMATED, WIRELESS VALVE COMPANY PTY. LIMITED

Administration: 47 York Street, Sydney — Manufacture: Parramatta Road, Ashfield



3AJE) have also been granted Attorney-General's permission to conduct raffles in Victoria in aid of the Fund.

The first raffle of a new 813 tube and socket will be held at the July meeting. A second 813 and socket will be raffled at the August meeting. Tickets are 1/- each and there is an unlimited supply available so any country Amateur who desires tickets should send a postal note, made payable to any of the abovenamed members of the Committee.

Total receipts to the Fund to date are £84/2/6, expenditure on food parcels £46/16/4, and cash in hand £37/6/2. Tune into VK3WI every Monday night at 7 p.m. for further news of the Appeal.

#### T.A.C. NOTES

**Committee.**—The executive meeting of the T.A.C. is held on the third Tuesday of each month at the Institute Rooms. The Committee are seeking ideas on the modification of the Type 3 Mark II for incorporation in a combined article on this equipment. A practical article on a completely Ham-built Amateur-band receiver is also required. Anyone who can supply these items are urged to forward same to Editor "A.R."

**V.H.F. Group.**—At the last meeting of this Group, 166 Mc. gear was exhibited by Reg Busch (3LS) and Ken McTaggart (3NW). After an explanation of the salient points and operation, an interesting discussion took place. Arrangements were also finalised for the combined 166/50 Mc. Field Day which was held on 21st June.

**Receiver Group.**—A meeting of this Group was held on 25th June, when a demonstration of the operation and aligning of Crystal Gates was given.

**Communications Group.**—Standard frequency transmissions (S.F.T.) and band edge location transmissions (B.E.L.T.) are now a regular monthly feature through 3WI, on the fourth Tuesday on 7 Mc. Spot frequency checks are available whenever 3WI is on the air. The Bush Fire Emergency Net frequency of 6984 Kc. will be covered in these transmissions.

**Library Group.**—Arrangements have been made for the issue of Library Books and Instruments at the general meetings in future, providing a request is received on the day before the meeting. If there are sufficient demands for a modulated oscillator for receiver alignment, the T.A.C. will obtain one for the use of members. Let your wishes be known to a member of the T.A.C.

**General Meetings.**—At the general meeting held on the 4th June, a very interesting and informative wire-recorded lecture of Professor Oliphant on Atomic Energy was presented. This lecture was appreciated by all, and whilst covering a large

scope, in simple language, gave everyone a better insight into the implications and possibilities of this intriguing scientific subject. Mr. E. P. L. Wall, Chief Navigation Instructor of A.N.A., will deliver a lecture on the Orientation of Beams and Great Circle Routes at the next meeting on the 2nd July.

#### S.-W. ZONE CONVENTION AT COLAC

The Convention was held in the auditorium of the local broadcast station and those present were VKs: 3AMP, 3JA, 3ZV, 3QC, 3BE, 3ALM, 3SE, 3BI, 3PD, 3KJ, 3KX and 3ZY. The meeting opened with 3AMP in the chair and before the office-bearers were elected it was decided that associate members would be permitted to vote on zone domestic matters only and not on any matter connected with operating or allied subjects.

Office-bearers were then elected and resulted as follows:—President: T. M. Palmer (3AMP); Vice-Presidents: S. Widgey (3SE), J. Anderson (3JA); Secretary-Treasurer: B. Scetrine (3BI); Committee Members: W. Brownbill (3BU), F. O'Donnell (3ZU), J. Ferrier (3MC).

In order to cover the rental of the auditorium and cost of postage and incidental expenses likely to be incurred during the year, zone membership was fixed at five shillings for

the first year and to be subject to review at a later date. Would those members not present send their membership fee along as soon as possible to the following address: B. Scetrine (3BI), 17a Raglan Street North, Ballarat.

3QC spoke on behalf of the Appeal for G Hams and it was agreed to ask zone members for donations and also to take a collection up at the end of the afternoon; this resulted in the sum of £2/10/6 being donated and 3QC is anxious for others who would like to contribute to this worthy Appeal to send donations direct to him at Terang.

The matter of field days was held over until the weather became a little more reasonable and predictable. It was decided that a zone hook-up should be held on the first Sunday in each month at 11 a.m. on 7 Mc.

To stimulate interest among members it was agreed to hold two DX contests. The phone section will be held on Sunday, 13th July, and the c.w. portion on Sunday, 27th July. Duration of both is six consecutive hours between 1400-2000 E.A.S.T. on previously mentioned days. All contacts outside VK to be counted as DX and number of contacts, multiplied by the number of continents worked, will be the score. The committee

# G L O - R A D

## SOLVES YET ANOTHER PROBLEM!

The experimentally minded Amateur has always been faced with the problem of getting special parts, etc., made at reasonable cost. Recent progress in V.H.F. and Micro-wave Techniques has further complicated this problem.

"GLORAD" is now in a position to cater for YOUR requirements, large or small.

Send sketches and full details to:—

**GLORAD ENGINEERING SERVICES**  
186A Riversdale Road (Cr. Robinson Road)  
**HAWTHORN ————— VICTORIA**

Phones: Day—WA 3819. Night—WX 3440

will rely on the "Ham honesty" of entries; confirmation of contact is not required and copies of the logs of competing stations are to be in with the secretary by Sunday, 3rd August.

3KJ very kindly donated two meters as prizes for the contests, one a 150 m.a. d.c. meter, and the other a 0.5 amp. r.f., so get busy fellows. Dud also offered a pair of 813s as a stimulous to zone members to break into the V.H.F. region for the first authenticated contact on 166 Mc. of 20 miles or over between zone members. They are to be the bait on the hook, so again go to it. Dud was thanked from the chair and a motion of thanks carried overwhelmingly.

3QC stressed the desirability of Hams, living reasonably handy to each other, getting together to form regular discussion groups which would help the chaps keep in touch with each other and be a source of knowledge to associate members. It was thought that a YF or YL Club should be formed too and probably these occasions could be combined with all joining forces for supper and any other social activity which would follow. The secretary would appreciate information from any such group so that it can be published and used as impetus to the formation of others.

The matter of an emergency network was brought up and it was thought that the zone should go ahead immediately and organise along lines as outlined below, members wishing to participate should be prepared to provide means of working on a spot frequency in a Ham band, viz.: 3.5 or 7 Mc. (this frequency to be decided upon by the committee later), then this frequency could be used for zone hook-ups and they themselves would become good practice in message handling, etc.

Finally it was decided that two conventions should be held annually—early in April and November, the first week-end in these months was chosen, Easter permitting! The next convention then will be at Warrnambool on the first week-end in November. The meeting then broke up with most of the fellows commenting on the bracing effect of the Colac climate.

Visits by those present were paid to the shacks of 3AMP and 3KX and were all impressed at the way DX rolls in at Ron's location, but they gathered Murray may be a serious competitor in the DX game if the number of aeriels in the Palmer back yard can be taken as any indication.

Remember the first S.-W. Zone hook-up will be on Sunday, 6th July at 11 a.m. on 7 Mc.

## QUEENSLAND

Secretary: R. Thorley, VK4RT, Box 638J, G.P.O., Brisbane.

Meeting Place: State Service Building, Elizabeth Street, City.

Meeting Night: Last Friday in each

The May general meeting of the Queensland Division was held on the 30th of the month at the usual QTH, the State Service Rooms. The President (4AW) occupied the chair, and Secretary (4RT) and Treasurer (4ES) also shared the official dais. It was most gratifying to hear the Secretary announce that our numbers have now passed the century mark. We feel sure that this is largely due to the service now being given to country members by 4WI, or should we say 4FN? One membership application recently received was from 4MU, a blind amateur, living in Mackay. The meeting unanimously approved 4RT's suggestion that he be awarded Honorary Membership whilst an Amateur.

Herb. Sprenger (4ES) reviewed the recent work of the Executive in obtaining Disposals Gear, and also announced that a quantity of Ground Plane Antennas were available. These are designed for 74 Mc. work, but are easily adaptable for 50 Mc. and even for 28 Mc.

By purchasing a quantity of these, the Institute has obtained them for approximately 6/- each. Intending purchasers are asked to contact the Secretary. Another buy, and a particularly good one at that, is the Combination known as the "522." We only had 24 hours to clinch this deal, but in that time managed to dispose of seven of them. The unit is a transmitter-receiver designed for the 112-150 Mc. range but is easily convertible to 50 Mc. Some power supply equipment is on its way over the horizon, but no further details at this sitting. At all events as everybody listens to 4WI these days these gems have rather lost their lustre.

To revert to the general meeting once again, the lecture programme was given a flying start by 4FN, with his excellent presentation entitled "Broadcast Studio Technique." Frank was well qualified to speak on this subject and Pat Kelly (4KB), in thanking 4FN on behalf of the meeting, surely echoed the sentiments of most of those present in saying that some of the B.C. station practices were a revelation, notably the fairly common practice of pouring all one's gain down the sink (to achieve an end, we hasten to add). The lecture was subsequently re-delivered over 4WI on the following Sunday morning and was met with enthusiastic approval.

4AW outlined the programme for the D.F. field day on the 22nd June and seven members offered their cars

for transport service. In an effort to find out the individual preferences of those present in regard to lectures, circulars were handed around and members asked to indicate their particular choices. In order to finance future Disposals purchases, it was suggested by 4KB that a pool be formed of interested members each of whom would contribute to a fund to be used for Disposals "buys." Some half dozen members announced their

## Australia's Largest Stock of All Radio Components

Chokes  
Coils  
Condensers  
Dials  
Intermediate Transformers  
Mose Equipment  
Potentiometers  
etc., etc.  
Resistors  
Soldering Irons  
Speakers  
Test Equipment  
Valves  
Pick-Ups  
Power Transformers  
etc., etc.

Obtainable from

## Bloch & Berber Ltd.

with which is associated  
the

## WELDON ELECTRIC SUPPLY CO.

## 46-48 YORK STREET, SYDNEY

G.P.O. Box 2282 M

Phones: MA 6291 (10 lines)

willingness to help. The Institute's resources at present do not permit of indiscriminate spending, hence the advantage of the scheme above.

In closing, it is the hope of the V.H.F. Section of the Executive (namely 4AW, 4RT, 4ZU and 4KB) that the glut of DR106s will see a little more activity on the band closest to their hearts, namely "Gud ole Six." On the day after their acquisition of same, 4ES and 4XG had them going on 53 Mc., which shows that it is not by any means a big job to convert the things.

## SOUTH AUSTRALIA

Secretary: E. A. Barbier, VK5MD,  
Box 1234 K, G.P.O., Adelaide.  
Meeting Place: 17 Waymouth Street,  
Adelaide.  
Meeting Night: Second Tuesday of  
each month.

The monthly general meeting for June was held at 17 Waymouth St. and the following visitors were present. Messrs. Kelly, Hampel, Little, Millard, Baxendale, Shultz, Wright, Moyle, VK2OX and PK6XA. The lecturer for the night was Mr. Cliff Moule (VK5CX) who chose as his subject "The Use of the Decibel," and judging by the interest and questions asked both during and after the lecture, Cliff did a good job with a subject that did not lend itself to interest.

Mr. Moule began by giving the derivation of the name decibel and sketched its growth and application whilst explaining and describing the various technical terms it superseded. Cliff gave a short blackboard example of logarithms for the benefit of those present, explaining that without at least a working knowledge of "logs" it would be impossible to appreciate the use or application of the decibel. The lecture was rounded off with a practical demonstration of d.b. increase and decrease on amplifiers, simple peak limiters, etc. He was assisted by Mr. Rogers who maintained a sphinx-like attitude throughout thus creating the necessary "atmosphere." Joking aside the practical demonstration was extra good and some of the phone men present must have blushed internally at some of the "S9 plus 40 d.b." reports they have been in the habit of giving. A vote of thanks was ably proposed by Mr. Ramsay (5GD) which was received with acclamation.

Following this lecture Mr. Ross Harris (5FL), with the aid of a build-up by Mr. Hal Austin (5AW, the President), gave an interesting talk on operating procedure. This talk was received with more than usual interest and whilst it was evident that members present did not wholly agree with Ross, the benefits of such a talk were apparent, and Ross is to be congratulated on his sincere and

praiseworthy attempt to raise the standard of Amateur operating. Interstate members please copy.

Finally, Lt. Bert Krygsman (PK 6XA) gave a short talk on his and other PK activities. This talk was very interesting and amusing, as Bert is an unconscious humorist, and but for the lateness of the hour the members would have appreciated more from Bert. To round all this up "Yours Truly" took the floor and gave a short explanation as to why the Amateur Notes were missing from the local paper on Saturdays. A petition was prepared immediately and signed by all members present bar one, who is to be congratulated on at least having the courage of his convictions. My closing remarks regarding the Women's Croquet Club were entirely misunderstood by the members, much to my embarrassment and their delight. The meeting closed at 10.50 p.m. with definite signs that all had enjoyed themselves once again.

VK2OX, who was present at the monthly meeting, gave members an indication that he would probably be a VK5OX. Welcome o.m. and if we can help in any way, don't hesitate to ask. Noticed new Council member George Ramsay (5GD) very busy at the general meeting. A decided acquisition to the Council.

"Nobby" Prince is busy working any DX available on 28 Mc. The DX is coming in so well to him one would be inclined to think they were locals.

Noticed young Michael Palk, brother of Brian Palk (5FQ) was one of the contestants in a quiz show over the air recently. Michael is often heard from 5FQ and has a very pleasing voice. Brian, what about "biting" Michael for his quiz prize money for a new tube?

Great activity in Seafield Avenue, Kingswood. The new three foot water main was being laid at record speed in this avenue until it reached number 12. Surely the water cooled tube doesn't use that much water Cecil?

The mad scramble between VK2 and W Hams for a contact with VR6AA during late afternoons recently did nothing to aid Amateur Radio. Say chaps, this game is a hobby not a fight for existence.

The appointment of Mr. John Allen (5UL) and Mr. Sheard to the Students' Class, as theory and code instructors respectively has met with the approval of all VK5 Hams. Mr. Allan's professional knowledge plus the varied experience gained during the war in the R.A.A.F. made him an ideal choice for the theory, and Mr. Sheard's ability with the code dates back 40 or 50 years to his association with the P.M.G.'s. Department. During the war the R.A.A.F. co-opted his services as code instructor at Parafield and his success with chaps who found the code hard to master

was phenomenal. The Council feels that in these two instructors they are giving the prospective Ham a solid foundation.

Mr. George Ramsay (5GD), who is the guiding hand behind the newly formed disposals scheme, reports business as good. George has a long list of bargains for sale, and members are advised to contact him if they have any radio gear to buy or sell. Country members will find that a letter to George might be the means of saving them a few pounds. Just write and say that you have to sell or want to buy and George will do the rest.

Where the rumour started that city members were getting issues of Commonwealth disposals gear to the exclusion of country members is hard to say, anyway it is all "hokey" and country members can rest assured that with the present Council the interest of the country Ham is given 100% consideration. By the way, if anybody hears any rumours why not contact Doc Barbier or any Council member and give them the opportunity to deny it. This is the only way to scotch rumours.

The official publication of the Professional Radio Employees' Institute of Australia "QTC" has decided to carry "Ham" notes in future because it is obvious that a large number of its members are keenly interested in Amateur Radio. My, my, we are beginning to be appreciated.

## WESTERN AUSTRALIA

Hon. Secretary: W. E. Coxon,  
VK6AG, Howard St., Perth, W.A.  
Meeting Place: Builders' Exchange,  
St. George's Terrace, Perth.  
Meeting Night: Second Monday in  
each month.

The June meeting was held on the 9th of the month, and was very well attended. 6GM presided, and welcomed visitors, A. Mead (VK2AJA), Hal Lee (ex-WIIRJ) and Harry Simmonds (VK6KX). After the business had been dealt with an interesting evening was spent. A debate on modulation was held, entitled "Quality versus Quantity," and was enjoyed by all present.

6KX was the Independent Adjudicator, and pronounced the winning side "Quality." The sides were:—"Quality"—6EV, 6FC; "Quantity"—6HL, 6PX.

6WG demonstrated Modulation Envelopes from a Flying Doctor Voice-Operated Carrier Transmitter, on a C.R.O. which was a good follow-on to the previous subject.

6WS followed with a demonstration of his little Transceiver of British design, and in conjunction with 6FR, explained it in detail.

The W.I.A. news is broadcast by 6WH on 7165 Kc. each Sunday at

0900. Please keep this channel clear boys. After the broadcast has finished 6WH will call country stations only who want any further information about the news notes, and when he goes over please call for three minutes. This will give him a chance to tune from one end of the band to the other to log stations calling 6WH. Don't call a dozen times before signing.

### PERSONALITIES

6DF has his brand new 50 ft. tower crowned with 3 antennas (3 element close-spaced 14 Mc., 3 element close-spaced 28 Mc., and 4 element wide-spaced 50 Mc.). A real fine effort. — 6HL has his new tower erected, and it is graced with a 2 element 14 Mc. beam plus a 3 element 28 Mc. — 6CB heard regularly now on 14 Mc. phone. Bert is now a QRM merchant with the rest of the boys. — 6NL has altered his modulator and now puts out a very fine signal. We believe Vic is cathode ray minded, and will soon be installing this type of monitoring. — 6EV is a very busy man these days with the Exchange Bureau. He is doing a fine job and is to be congratulated on his efforts. — 6RU is receiver building again. Jim is on a "super-duper" coil unit, one that he reckons will even out-do the Atom Bomb in its sensational results.

6WH is still heard regularly on 7 Mc. keeping that band warm, and

also from the wolves who would like to tear it away from the Amateurs. — 6KW has been a busy man of late, fitting an electrically driven turning mechanism to his beam. Results are excellent, and it's turned out how he expected it would. Even the Selsyn Indicator is working O.K. — 6WS not heard as regularly as usual. Are those country trips keeping you off Skipper? Anyway you're not missing much. — 6FL has reached the stage of painting his tower. Guess the skyline of Subiaco has yet undergone another change. — 6KE regularly heard keeping VK6 on the map and making a hole in the ether from Cottesloe way. — 6GM is a nightly pounder of "brass." What's happened to the phone Cliff? You have to think of the status of QRM (Inc.) of Subiaco so what about it?

### SURPLUS GEAR AND EXCHANGE BUREAU

Great activity in the Surplus Gear and Exchange Bureau lately, particularly in the way of tubes. The Division has been fortunate in acquiring quite a range of new Disposals tubes and a large quantity have been sold. There are still a few types available, though the 1852 at 12/6 have greatest surplus.

If you require anything, including assistance in purchasing, especially if you are an out-of-town member, just

drop a line to 6EV, at 272 Crawford Road, Maylands, or the W.I.A., Box N1002, and he will do what ever he can for you.

NOTE.—When ordering equipment, order should be covered by remittance made payable to W.I.A. and sent to 6EV. Some stuff has to come from the East, so don't be surprised if you have to wait a couple or three weeks. This applies mainly to tubes.

## TASMANIA

Secretary: J. Brown, VK7BJ  
12 Thirza Street, New Town.  
Phone W 1328.

Meeting Place: Photographic Society's Rooms, 163 Liverpool Street, Hobart.

Meeting Night: First Wednesday of each month.

Council meeting for May was held at T. Connor's (7CT) home, 285 Elizabeth Street, North Hobart, at 8 p.m. on Friday, 7CT, 7BJ, 7CJ, 7CW, 7RF, 7PA. Minutes of previous meeting were read and confirmed. Secretary reported business quiet, quite a let up after the pressure of Convention. General Business: the items referred back from Convention and the general meeting's decisions were reported.

Secretary read a copy of a letter sent to A.R.R.L., C.Q. and R.S.G.B.

# RED LINE TRANSFORMERS & CHOKES

For the F.F.R. Amplifier

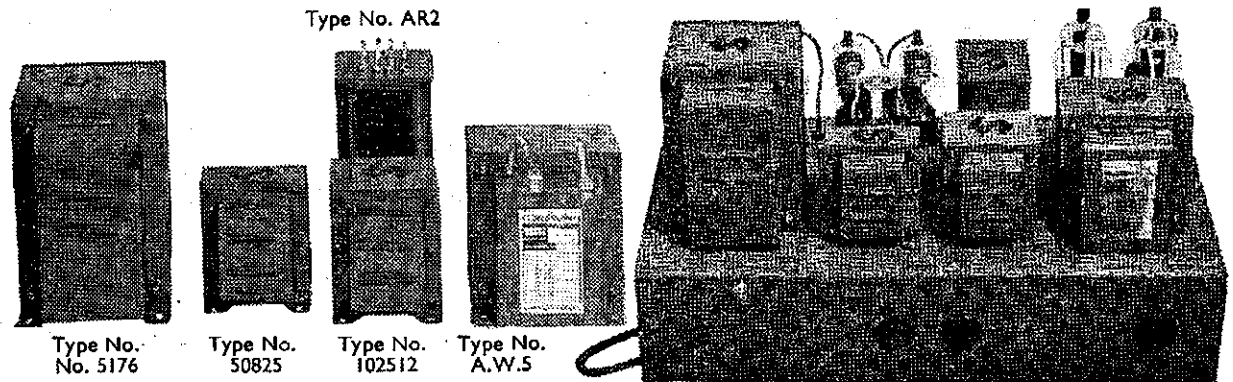

Pamphlet describing design and construction of the Full Frequency Range Amplifier available from:

## SWALES & SWANN

Technical Service, A. T. SWALES, Cent. 4773  
Wholesale and Manufacturers: 2 Coates Lane, Melbourne.

Trade Sales: ALLEN SWANN  
MU 6895 (3 Lines)  
157 Elizabeth St., Melb.

# A.G. HEALING

LIMITED

MANUFACTURERS AND  
DISTRIBUTORS FOR . . . . .

Electrical and Testing Instruments for all purposes made to British Standard specifications. Each instrument is accurate, + or -, to 2 per cent., and parts are heavily plated to prevent corrosion even under tropical conditions. "Healing" Electrical Meters equal the best imported types and will give accurate service for long periods under the most exacting conditions.

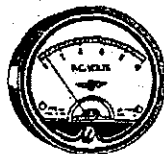

No. 10A round production mounting Black Bakelite Case.

Type No. 30A 4" square semi-flush Black Bakelite Case.



No. 20A 2½" round flush mounting Black Bakelite Case.

These, and all other Healing Radio Electrical Testing Units, are manufactured in our own factories and available from A. G. Healing Ltd.

**OTHER INSTRUMENTS INCLUDE:**

Oscillators — Multi-Testers — Signal Tracers, etc.

**ALSO MANUFACTURERS AND DISTRIBUTORS FOR**

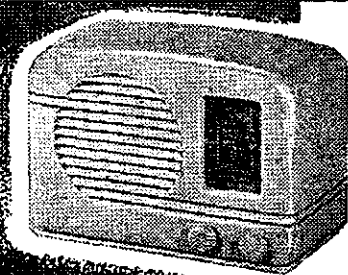

## Golden Voice RADIO

A. G. HEALING LTD., MELBOURNE, SYDNEY, ADELAIDE

re the listing of VK7 in countries' list.

**New Members.**—Applications from F. J. Evans, full city; D. G. Peck, city associate; M. J. Ruper, Burnie, and P. J. Crawford, Launceston, country associates, were received and passed on for next general meeting.

The main item, Mrs. Connor's supper, was then attended to and with the saying of thanks for her attention, the meeting closed.

**General meeting at the Rooms at 8 p.m. on 4/6/47.** Correspondence: Radiograms re VK3 and LU 50 Mc. working and new Federal Executive, letters from VK7 to Federal Secretary re decisions on Convention items which were all in the affirmative. Increased cost of "A.R." to 6d., inclusion of "A.R." in subscription of full members with 5/- increase in subscription, paid secretary for Federal Council and alteration of end of financial year to 30th March. The meeting endorsed the action of Federal Council in the selection of new officers to fill the vacancies; moved 7CL and seconded 7AL. New members were elected.

The chairman in welcoming the new members present said he hoped they would find pleasant association with members of the Division, he

also welcomed Mr. Aschmann as a visitor and suggested a nomination card for him. Mr. Aschmann said he hoped to receive a station license any time and then become a full member. Dinner committee reported that all was well only that a hotel was not to be had, a local cafe had accepted the job.

**Food for Britain.**—A report from 7XA was to the effect that with more funds he would be happy so a hat around realised £5/11/6 to satisfy temporarily his needs, this making it possible to complete another batch of 25 parcels. Here are the figures promised last month: cash received to date £30/19/3½, parcels forwarded 26, preparing 25. Since this scheme was started and advertised in our monthly bulletin to members, cash has been received from throughout the State including Waddamana and Launceston.

**General Business.**—The main item arose out of the International Telecommunications Conference and some lively discussion ensued and after thrashing the subject soundly a couple of motions eventuated. (1) That this Division do what they can to promote interest in the Ham ideals amongst influential bodies—the Services, Parliament, etc.; moved by 7AL and seconded by 7KA and carried.

(2) That the above matter be left to the incoming Council to take the necessary action; moved 7TR, seconded 7XA, carried.

7TR gave some information on the alterations to allocations arising out of a contact he had with a W and his complaint made to said W re VK7 alteration. Seems he has been doing a bit of personal correspondence with Goodman, of A.R.R.L., which has already started the ball rolling. He outlined how the change came to be made; something about political areas but seems that the Gs concerned forgot England, Scotland, Wales, etc., which seems to annull the political divisions argument.

The idea of making a documentary film of amateur activities for general circulation is being investigated and some progress has been made; this is a matter that should interest most divisions and we would like to hear other impressions on it. We have a special committee working on the idea with 7LJ at its head, being an ardent photographer himself and a member of the Photographic Society, Lon., should know the "right people."

**ANNUAL GENERAL MEETING**

This meeting was held at the Rooms at 6 p.m. on Saturday, 14th

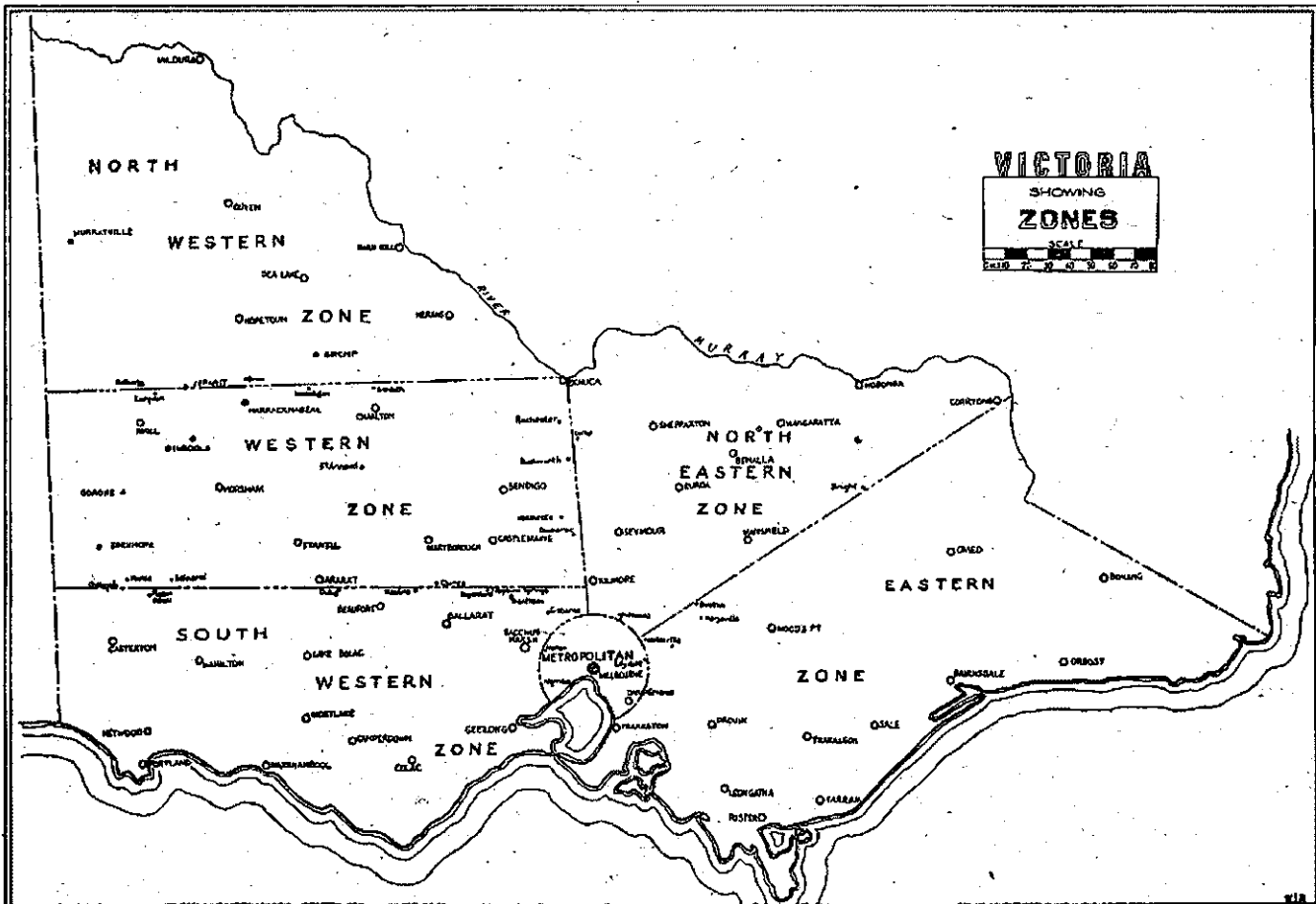

June, to a large attendance. The President read the annual report which showed a year of remarkable progress and activity. On a proposal by 7AL, seconded by 7TR, the report was adopted. The treasurer's report showed a financial improvement in keeping with the rest, the balance having increased from £8/9/2 last year to £22/10/11 this year.

During the year £69 had been handled including "A.R." subscriptions, stationery, rental of rooms, notices, postage, etc., were the main items of expense. On the motion of 7PA, seconded by 7CT, this report was adopted.

The following appointments were made:—Patron: F. W. Medhurst (7AH); QSL Manager: T. A. Allen (7AL); Publicity Officer: 7YY; Traffic Manager: 7YY; Vice-Presidents: 7PA, 7CW and 7BQ.

Northern members for Council were 7LZ (C. W. Wright of Launceston) and 7AB (D. Fisher of Burnie) who were re-elected unopposed. 7LZ agreed to arrange for notes to "A.R." to be supplied from the northern end, a much needed addition.

Some discussion took place about the present "Ragchewing Sessions" and the previously reported suggestion that alternate evenings and mornings be adopted was agreed to and set out as follows:—second Friday 8 p.m. and fourth Sunday 9.30 a.m. each month either phone or c.w.

It was agreed to hold the annual general meeting and dinner on the long week-end in March when better weather and longer days should be an advantage to all.

7LJ was elected President again and 7BJ, 7CW, 7LJ, 7CJ, 7RE, 7CT and 7TR were elected as Councillors. Thus the Council and officers for the ensuing period (nine months) are, with one exception (that of 7TR replacing 7PA), unaltered. One addition has been made to the Vice-Presidents, the inclusion of our northern old-timer, Len Crooks (7BQ). Auditors are 7NL and 7OM. At the close of the meeting an adjournment was made to the Windsor Café where dinner was partaken.

#### ANNUAL DINNER

The fare provided was good as was the amber fluid and all were satisfied. The toasts of the evening were along the usual lines and many good and interesting points were made and anecdotes told by the speakers.

Regrets were expressed at the news of Mr. Burbury's intended transfer to Adelaide and the good wishes of the members were tendered him through his deputy, Mr. Carroll. We trust that his successor will be as understanding as he has been.

Before concluding the programme, Mr. J. Brown moved a vote of thanks to the committee for the able way the dinner arrangements had been carried out and Mr. F. Gee replied stating that it was really nothing.

#### DX BOOK-KEEPING

(Continued from Page 7)

**Entries.**—As new countries are contacted, the Station Log page number should be entered opposite the country and under the appropriate band.

The country contacted may be underlined, as well as prefix and zone. The log page number under band is underlined when a QSL is received from that country. By totalling the

"underlines" for each page, under:—

- (1) Prefix—the total countries QSOed is known.
- (2) Individual Bands—the total country QSLs for each band is known.
- (3) Total (under Bands)—the all-band total QSLs are known.

A single page summary of all pages, A to Z, may be included at the front of the log, where progressive totals are made.

## FOR SALE, EXCHANGE, WANTED

9d. per line, minimum 2/-.

**FOR SALE, A SPECIAL!**—One 100 watt Ham phone transmitter absolutely complete, relay operated, with all tubes, power supplies, modulator, band-switched exciter, all in rack and cabinet construction. Details on application. B. M. Plowman, 111 High St., Terang, Victoria.

**FOR SALE.**—Eight Tube Super, coils all bands to 28 Mc., xtal filter, £25. VK3JA, Nullawarre, Victoria.

**FOR SALE.**—New 813 tube and socket, CV6 tubes; one FS6 receiver converted to a.c. with tubes, no power supply; one U.H.F. modulated oscillator, bandswitched from 17.5 to 160 Mc.; two pairs 120 ohms phones, new. B. M. Plowman, 111 High St., Terang, Victoria.

**FOR SALE** pair RCA 801s, as new, £2 pair. VK3UJ, 48 Baker Parade, Ashburton, E.13.

**FOR SALE** pair 805s with sockets, £6 pair. Pair of 801s, £1/10/- pair. These tubes have been little used, are in good condition and can be tested if desired. J. Symons, VK3JT, 30 Eleanor St., Burwood, E.13, Victoria.

**WANTED URGENTLY.**—One Trip-let 0 to 50 or 0 to 100 m.a. meter, model 326, square dial type. Will pay £3 or swop gear for one. H. G. Wohlers, VK3YV, Wangaratta.

**FOR SALE.**—Six only new Type A Mark III Transceivers, 5 watt c.w., 3.2 to 9 Mc., a.c. or 6 volt; complete with vib. unit, 3 spare valves, phones, instruction book, etc., £10.

One only Piezo Astatic T3 Microphone, new, £8/5/-.

Ten-line U.C. Switchboards with magnetos, no handset, £1/10/-.

K. V. Scott, VK3SS, Johnson St., Maffra, Victoria.

**FOR SALE.**—13 Tube A.W.A. Communication Receiver, 2 r.f., 3 i.f. stages, xtal filter, S meter, complete with a power supply and speaker, cont. freq. coverage 2.5 to 22 Mc., £79/10/- or near offer. J. Miles, Wireless Stn., Ballan, Phone 61.

**WANTED.**—Class "C" Wavemeter, any condition. Power supply and valves not essential. VK3LL, 4 Beech St., East Malvern, Phone UL 1642.

**WANTED TO BUY.**—Kingsley AR7 Receiver in good order and condition. S. E. Widgery, 703 MacArthur St., Ballarat, Victoria, VK3SE.

**WANTED TO BUY OR EXCHANGE.**—Genuine National H.R.O. Coils, any frequencies. B. M. Plowman, 111 High St., Terang, Victoria.

#### OPTIMUM OPERATING CONDITIONS FOR TYPE 807 VALVES (AUDIO)

Anode Volts	Screen Volts	Peak A.F. Volts	Fixed Bias	Cathode Resistor	Anode Current Ma.	Screen Current Ma.	Load Ohms	Output Watts
PUSH PULL CLASS AB <sub>1</sub>								
360	270	45	—22.5		88-140	5-11	3,800	18
400	250	43.8		190	96-110	5-11	8,500	24
360	270	45	—22.5		88-140	5-11	6,600	26.5
400	300	57		200	112-128	7-16	6,600	32
400	300	50	—25		102-152	6-17	6,600	34
500	300	50	—25		102-156	6-17	8,600	44
600	300	55	—27.5		80-149	5-17	10,000	54
PUSH PULL CLASS AB <sub>2</sub>								
400	300	78	—25		102-240	5-10	3,200	55
500	300	78	—25		102-240	5-10	4,240	75
600	300	78	—30		60-200	5-10	6,400	80



**REMEMBER** . . . you get the **MOST** satisfaction  
from

**LAWRENCE & HANSON**

• **RADIO PARTS** •

**Need We Remind You**

. . . that during the years of Radio history we have followed with much interest and pride the remarkable progress, ingenuity, skill and enthusiasm of you—the Amateur Broadcasters of Australia.

As enthusiasts of a fascinating hobby, you have perhaps graduated to bigger and better things in radio, or maybe, you're quite content to remain enthusiasts and get the most from your set.

And that's what interests us—**getting the most from your sets!**

Ever since radio was in its infancy, many amateurs have relied solely upon

**LAWRENCE & HANSON RADIO PARTS**

— the high quality radio components renowned for their long years of unflinching, dependable service. Moreover, L. & H. have the widest possible range of radio parts found anywhere. Look around town—you just can't get a more selective, more reliable, more satisfying range!

For dependable radio broadcasting equipment  
rely on—

**LAWRENCE & HANSON RADIO PARTS**

Obtain latest lists and prices from your radio house!

Here's a list of  
**L. & H. Radio Components** that's sure to  
interest you!

- \* Microphones
- \* Batteries
- \* Switches
- \* Vibrators
- \* Chokes
- \* Condensers
- \* Coils
- \* Meters
- \* Valves
- \* Transformers
- \* Chasses
- \* Speakers

Technical Advice given  
on request.

**LAWRENCE & HANSON**  
**ELECTRICAL PTY. LTD.**

33 YORK STREET, SYDNEY.  
120 COLLINS STREET, HOBART.  
87 ELIZABETH STREET, BRISBANE.

172 WILLIAM STREET, MELBOURNE.  
60 WAYMOUTH STREET, ADELAIDE.  
20 PATERSON STREET, LAUNCESTON.



# Are You Looking for **SELECTIVITY?**

## Then Try the New **"AEGIS" HI-CORE I.F. TRANSFORMERS**

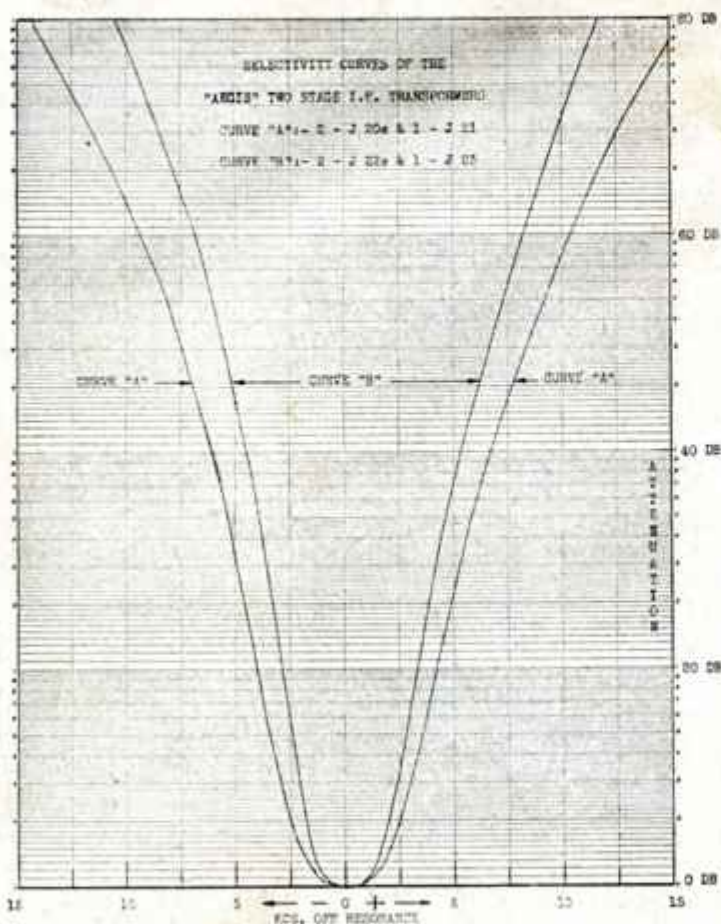

Scientifically Designed  
Expressly for the  
Two-Stage I.F. Channel

**INCORPORATING  
THESE FEATURES**

1. Maximum Stability
2. Excellent Selectivity, particularly types J22/J23.
3. Effects of Tube Loading reduced to a minimum.
4. "Miller Effect" Detuning eliminated.

Medium Selectivity	
Type J20 Interstage	Price 13/9 ea.
Type J21 Diode	Price 13/9 ea.
Maximum Selectivity	
Type J22 Interstage	Price 15/- ea.
Type J23 Diode	Price 15/- ea.

NEW AEGIS D/W COIL ASSEMBLY  
Type K15 and K25.

Specially designed for the new  
**G.S.A.7 SINGLE-ENDED TUBE**

No extra for this advanced feature!  
FROM ALL DISTRIBUTORS OF . . .

**AEGIS MANUFACTURING Co. PTY. LTD.**  
208 LITTLE LONSDALE ST., MELBOURNE

# AMATEUR RADIO

AUGUST  
1947

JOURNAL OF THE WIRELESS INSTITUTE OF AUSTRALIA



*full steam  
ahead*

TO BETTER RADIO

with

**PHILIPS**  
*VALVES*

PHILIPS ELECTRICAL INDUSTRIES OF AUSTRALIA PTY. LTD. Sydney, Melbourne, Perth, Adelaide, Brisbane



FOR THE EXPERIMENTER & RADIO ENTHUSIAST

Registered at G.P.O., Melbourne. for transmission by post as a periodical.

**6**<sup>d.</sup>

*On the beam...*  
*with KINGSLEY*  
*radio equipment*

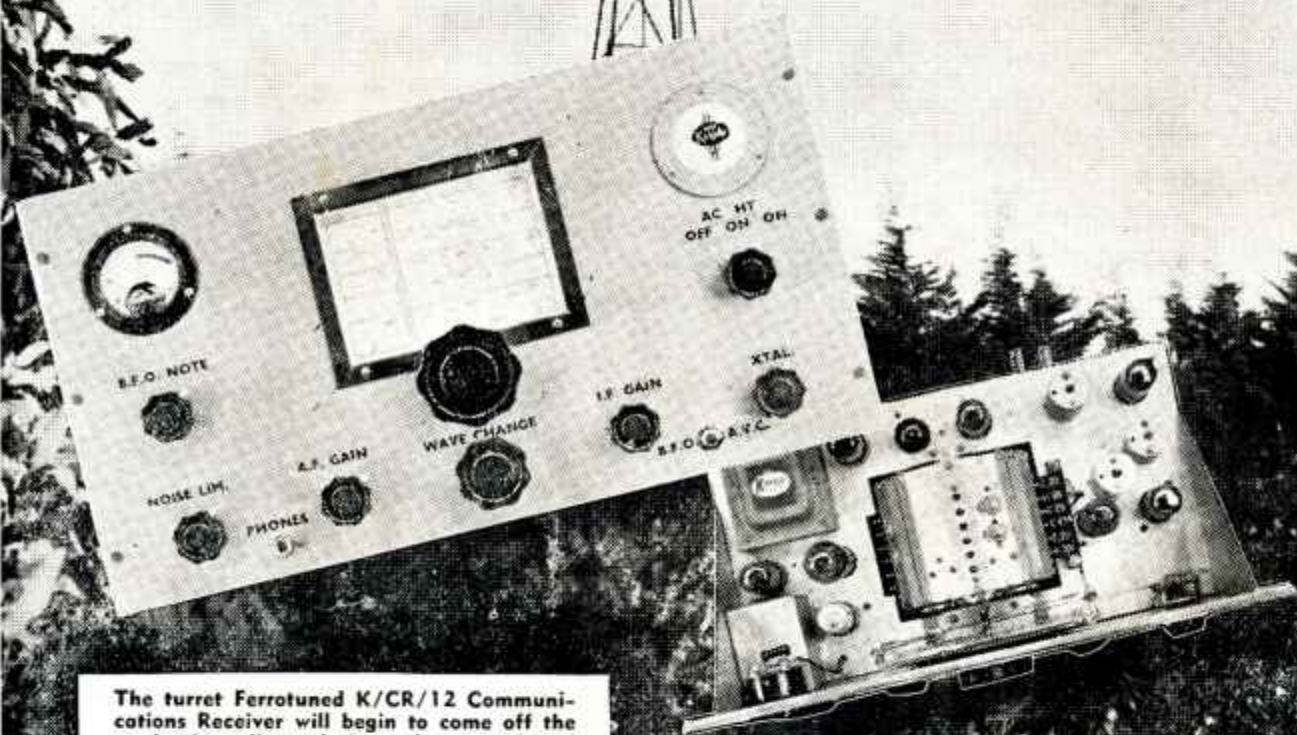

The turret Ferrotuned K/CR/12 Communications Receiver will begin to come off the production line during the month of August. Production will be limited, and supplies to customers will be strictly in accordance with date of order.

Supplies through all Kingsley Distributors.



**KINGSLEY RADIO**

KINGSLEY RADIO PTY. LTD.

380 St. Kilda Road, Melbourne, Victoria . Phones: MX 1159, MX 3653

AUGUST — 1947

Vol. 15

No. 8

# AMATEUR RADIO

Published by The Wireless Institute of Australia,  
Law Court Chambers, 191 Queen Street,  
Melbourne, C.1

**Editor:**

T. D. HOGAN, VK3HX.

Telephone: UM 1732.

**Technical Editor:**

J. K. RIDGWAY, VK3CR.

**Notes Editor:**

R. W. HIGGINBOTHAM, VK3RN.

**Distribution:**

H. N. STEVENS, VK3JO.

**Business Manager:**

J. G. MARSLAND, VK3NY.

**Advertising Representative:**

W. J. LEWIS,

20 Queen Street, Melbourne, C.1.

Telephone: MU 5154.

**Printers:**

H. HEARNE & CO. PTY. LTD.,

285 Latrobe Street, Melbourne.

MSS. and Magazine Correspondence should be forwarded to the Editor, "Amateur Radio," Box 2611W, G.P.O., Melbourne, on or before the 15th of each month.

Subscription rate is 6/- per annum, in advance (post. paid).

— IN THIS ISSUE —

Variable Frequency Oscillator ...	3
W.I.A. International DX Contest ...	7
Australian DX Century Club ...	9
Such Nice People ...	11
Federal Notes ...	12
Federal QSL Bureau ...	14
Divisional Notes ...	15
Fifty and Up ...	22
Telegraph Manipulating Key Design ...	24

## EDITORIAL



A recent announcement by the Postmaster General, Senator Cameron, has indicated to Amateurs that their Services during the war were appreciated and recognised in official quarters.

At the same time it was announced that the regulations governing Radio Amateurs were under revision and would permit many Amateur Stations to increase their power, to use frequency modulation and pulse transmission. The Postmaster General thus made public some of the important changes to existing regulations which have been under discussion between the Radio Inspector's Department and the Wireless Institute of Australia during the past twelve months.

It is a fact that the cordial relations existing between the Radio Inspector's Department and Amateurs generally has been developed as a result of a keen desire to improve and widen the knowledge of the radio art by both parties.

It is also a fact that Officers of the Radio Inspector's Department have shown a deep personal interest in the administration of the regulations governing Amateurs, in ways best calculated to encourage the devel-

opment of technical knowledge and experimentation, thus enhancing the national value of a section of the community whose knowledge has, and can be, extremely valuable in these days of scientific warfare and electronic development.

Naturally in the post war period of changing conditions, international telecommunication conferences, new methods of communications etc., it is not difficult to understand why new regulations must be carefully considered before promulgation.

It is the more difficult therefore to understand why various individual Amateurs have made approaches to Parliamentarians, to seek their aid in obtaining permission to use additional methods of communication and increased power, when such facilities were in process of being granted by the Postmaster General's Department.

Such approaches, however well intentioned, do nothing to strengthen and maintain the satisfactory relations which have always existed between the authorities concerned with the administration of Amateur affairs and the Amateur's representatives.

W.R.G.

# Leaders in RADIO Since 1908

# HOMECRAFTS

## Offer these Outstanding After Stocktaking BARGAINS

★ COMBINATION CABINETS,  
Beautiful Piano finish (uncut) **£15/19**

★ 40 MA Power TRANSFORMERS  
Vertical Mounting with Terminal Strip. **14/11**

Unassembled Crystal  
DETECTORS **1/3**

Iron Cored 2 Stage DUAL  
WAVE UNITS **29/11**

Single Circuit Small PHONE  
JACKS **1/6**

455 KC BOBBINS. Suitable for  
Modulated Oscillators **1/6**

Capitol Homebroadcaster  
or MICROPHONES **7/11**

200 MFD 12volt ELEC-  
TROLYTIC CONDENSERS **1/6**

6 Volt 4 Amp. Selenium Recti-  
fier BATTERY CHARGERS **4 Gns**

Imported Bradley POTENTIO-  
METERS 10,000, 20,000,  
30,000 Ohms **1/11**

BATTERY CHARGERS—6 only—Shop  
Soiled. 4 Battery Size  
Complete with Amp-  
meter. **£14/10**

★ VALVE CANS suitable  
for 1.4 volt valves **4d.**

★ D.C. MULTI-  
METERS. 10 **£6/19/6**  
Changes.

*Homecrafts* THE RADIO SPECIALISTS  
PTY. LTD. Central 4311

Head Office: MELBOURNE, 290 Lonsdale Street, and at 211 Swanston Street, Melbourne.  
139 Moorabool Street, Geelong. 307 Sturt Street, Ballarat. 100 Clarence Street,  
SYDNEY. 26 Hunter Street, Newcastle. Hobart, Launceston, and Burnie, TASMANIA.

# A VARIABLE FREQUENCY OSCILLATOR

By J. C. DUNCAN, VK<sub>3</sub>VZ\*

Intelligently used, a v.f.o. can be the means of reducing QRM on our bands, and increasing your operating pleasure. Thoughtlessly used, it will increase QRM and bring down wrath on you and your station from all fair minded Amateurs. The category into which you are placed by your fellow Amateurs will depend on you.

Since our return to the air, it has become more and more evident that the QRM situation is very much worse than pre-war.

It was felt therefore that if a flexible method of frequency control were used, quite a lot of the QRM on the radiated signal could be eliminated. This has since proved to be the case, and a reduction of 80% in reports of QRM have been experienced at this station, since the v.f.o. has been in operation.

Quite a large proportion of amateurs are wary of v.f.o., because they fear out of band operation, and therefore it was considered a necessity that a built in crystal check circuit be available. The following specification was drawn up, and after three months of spare time experimenting, a unit which satisfied all these requirements was evolved.

## The v.f.o. must have:—

- 1—Complete isolation of the oscillator from output circuit loading.
- 2—Stabilisation against line and plate voltage variations.
- 3—Satisfactory keying of the oscillator without clicks or chirps, for break-in operation.
- 4—Built-in crystal check circuit.
- 5—Compensation against changes in frequency due to temperature variations.
- 6—V.F.O. note available in the receiver, without radiation from the transmitter, for netting and choosing the operating point in the band.
- 7—Mechanical stability.
- 8—Dial accurately calibrated, directly in frequency, for all bands to be used.
- 9—Unit small, self-contained, with own power supply, and located on operating desk.
- 10—Switches on unit to relay-control operation of the transmitter.
- 11—Three stage speech amplifier with 600 ohm output, suitable for input to a driver stage for class "B" modulators.

\*23 Parkside Av., Balwyn, Victoria

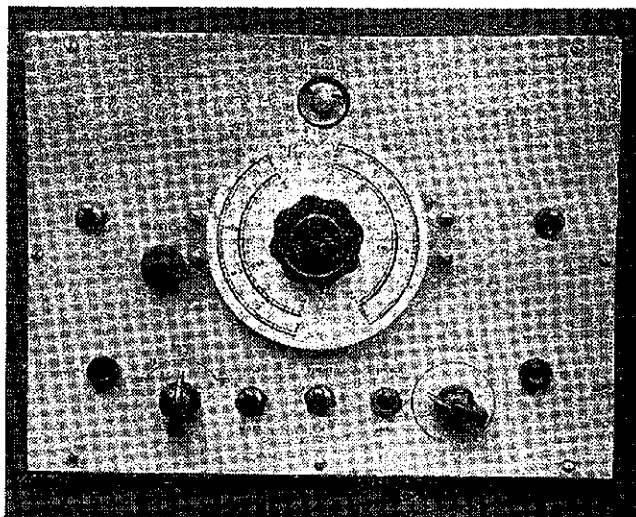

## ELECTRON EYE, CRYSTAL RESONATOR CIRCUIT

An electron eye, crystal resonator circuit is used, and at the resonant frequency of the crystal the shadow angle of the eye increases sharply as the v.f.o. is tuned through this point. This circuit can be used with two crystals connected in parallel, and indication of resonance will be obtained with both, however the sensitivity of the eye is decreased with the circuit values given here, and it may be necessary to experiment with resistance values to obtain a good indication with two crystals. This would enable two band-edge crystals to be used, an obvious advantage. However one crystal located in the frequency range of the oscillator is all that is necessary, and in practice a small red line is drawn on the dial calibrations at the crystal resonance. The v.f.o. dial is set to this red line, and the small correction condenser adjusted to give maximum opening of the eye.

This electron eye circuit is used in the SCR274N aircraft transmitter, and its operation is as follows: The triode section of the 6U5G acts as a "biased detector" and at the resonant frequency of the crystal, draws plate current, causing an increase in the voltage drop between target and plate, thereby increasing the shadow angle of the eye.

A tap is taken from the e.c.o. coil one turn from the cold end, and after passing through the 50,000 ohm isolating resistor, connects to the electron eye grid. The crystal is connected from this point to earth. The isolating resistor is fairly critical and should be of such value that there is no pulling of the v.f.o. when approaching the crystal frequency. The cathode resistor controls the off resonance shadow angle of the eye, large values decreasing this angle. The sensitivity of the eye, i.e. the opening of the eye on resonance is controlled by the 1 meg. and 0.5 meg. plate resistors, large values making the eye more sensitive. If two crystals on the band

Provision has been made for item 11, but as this amplifier is not required with the present transmitter, it will be wired at a later date.

The circuit diagram is shown in Figure 1.

## OSCILLATOR CIRCUIT

The oscillator circuit is entirely conventional in design, and operated originally on 160 metres, but tests showed that results were just as good when used on 80 metres, and as more amateurs are in possession of 80 metre crystals (for the resonator circuit), it was felt that this frequency would be of more use generally. However coil data is given for both bands.

The oscillator is very high "C," the total capacity being in the region of 850 pfd., this reduces the effects of tube interelectrode capacity changes to a very small amount, during the initial warming up period.

With such large amounts of capacity, changes of frequency with rising temperatures, becomes an important factor in the stability of this oscillator, and therefore portion of the lumped capacity in the circuit is made up of a negative co-efficient condenser. The method of temperature compensation is discussed later. The screen and plate of the oscillator are supplied from a voltage regulator type VR150/30, the screen having no dropping resistor with this low plate voltage.

Keying in the screen lead has been most effective, without any trace of chirps, and nearly all reports on c.w. are T9X. Clean keying is mainly due to the following points. (1) Voltage stabilisation of the oscillator. (2) Voltage regulation (entirely separate to item (1) and discussed later). (3) Use of an isolator following the oscillator. (4) Screen keying. (5) Small values of screen and plate bypasses.

The one disadvantage of screen keying is the high voltage on the key, however a relay could be used here if desired.

edges are used, by choosing a suitable value of isolating resistor, it should be possible to cause the v.f.o. to lock to the crystals at each end of the band with this circuit, an interesting possibility.

### ISOLATOR STAGE

The isolator stage is untuned and has two important functions. Firstly it prevents changes in tuning and loading of the buffer amplifier from effecting the oscillator frequency, and secondly because the interelectrode capacities of the oscillator, isolator and buffer amplifier are in series between the two tuned circuits, it is possible to use a tube in the buffer amplifier having relatively poor grid-plate isolation.

A 5,000 ohm plate resistor is used in the isolator output circuit, to avoid any possibility of resonance with the r.f. choke in the oscillator plate circuit. This happened in the original circuit, and substituting the resistor cured the oscillation, and did not decrease the output of the unit.

### BUFFER AMPLIFIER

The buffer amplifier is conventional except for the output tank circuit which is slug tuned over its full range with only a slight falling off of output at each end. Output is through a co-ax connector to the transmitter.

A 6V6G can be used in this stage with a slight increase in output, but a 6F6 was chosen because of its better grid-plate isolation. The output tank consists of 80 turns of 35 s.w.g. enamelled wire wound on a  $\frac{3}{8}$ " Polystyrene former, with a  $\frac{3}{8}$ " brass disk tuning slug mounted so that it screws into the centre of the coil. The secondary winding is 7 turns of 29 s.w.g. enamel wound  $\frac{1}{16}$ " below the primary winding.

### POWER SUPPLY

The power supply is entirely conventional and needs few comments. It is necessary to use two sections of filtering to obtain a pure crystal note from the oscillator, and also the values of isolator and buffer amplifier screen and cathode resistors were chosen so that, under key up and key down conditions, an almost constant current is drawn from the power supply, in this case the variation is 3 Ma. With an output of 275 volts from the power supply the currents drawn by the three stages are: oscillator 8 Ma., isolator 10 Ma., and buffer amplifier 30 Ma. The voltage regulator takes 22 Ma., and 30 Ma., key down and key up respectively.

### CONTROL CIRCUITS

The transmitter is relay controlled and to change from send to receive on phone it is only necessary to throw the send-receive switch on the receiver. The relays used are the type commonly available from disposals, having a 75 ohm coil and d.p.d.t. and d.p.s.t. contacts. They are powered from a supply consisting of a step

down transformer, and a 12 volt 1.5 amp. dry metal rectifier. This supply is simple, needs no attention and will operate up to 10 relays if required. The toggle switches on the v.f.o. are manufactured in Sydney, and have four connecting lugs each end. The control circuits are operated as follows:—

**Filaments and Bias Switch** closes primaries of filament and bias supplies in transmitter, also powers time delay relay in h.t. primary, and a.c. to v.f.o.

**H.T. Switch** supplies a.c. to h.t. primary, if h.t. time delay has already closed.

**Phone-C.W. Switch** connects relay contacts of relay in v.f.o. into circuit. This relay is connected to operate from send receive switch on receiver. In phone position, the relay contacts are connected, one pair of contacts closes screen of oscillator and as the transmitter is biased to cut off, gives r.f. output, and second pair of relay contacts closes modulator relay in transmitter. With toggle switch in c.w. position, relay contacts are disconnected, and keying is done from key jack on v.f.o.

**V.F.O. Note Switch.** In the on position, one pair of switch contacts closes the screen of the oscillator, and second pair of contacts opens the buffer amplifier cathode. With voltage stabilisation and voltage regulation, there is no change in oscillator frequency with the rise in power supply voltage. The v.f.o. note is then of sufficient signal level in the receiver to make netting or selection of a clear spot in the band quite easy.

### CONSTRUCTION

The unit is built on a 10" wide x  $10\frac{1}{2}$ " deep x 3" chassis, with a  $11\frac{1}{4}$ " x  $8\frac{1}{2}$ " front panel, and enclosed in a  $11\frac{1}{2}$ " wide x 11" deep x  $9\frac{1}{2}$ " high metal case. There are three outlets at the rear of the chassis for mains, r.f. co-axial, and a twelve pin connector for the relay circuits. The oscillator and isolator, complete with associate components, are mounted on a  $6\frac{1}{2}$ " x  $6\frac{1}{2}$ " x  $\frac{3}{8}$ " dural, or hard aluminium plate, which is mounted by three rubber grommets to the chassis. The main condenser and corrector condenser shafts protrude through the front panel and care must be taken to see that these shafts do not touch the front panel, so fairly large holes are cut to avoid this.

The main tuning condenser C1 is a double spaced job and has 11 plates, the two outer rotor plates were removed, giving the oscillator 3.5-3.61 Mc. coverage on the fundamental range. This condenser is a disposal job and originally had a spring loaded gear train on the front. The gear train was removed and a 3:1 planetary reduction drive (also disposals) substituted. By removing the old fashioned bakelite knob on the reduction drive, the back flange

which had holes for two mounting screws, was exposed and a celluloid dial fitted as shown in the illustration. It can be seen therefore that the main condenser, reduction gear and celluloid dial are mounted on the rubber mounted dural plate, and do not contact the front panel at any point.

The small corrector condenser C2, mounted on a small angle and located to the left of the main condenser, is a 4 plate double spaced disposals job. Behind these two condensers is a strip of Polystyrene  $5\frac{3}{8}$ " long x 2" wide x  $\frac{1}{4}$ " thick mounted on four  $\frac{3}{8}$ " high pillars. This strip carries the main trimmer condenser C3, coil former, crystal, resistors and condensers for the oscillator. The oscillator and isolator valve sockets are mounted near the rear edge of the mounting plate and are also on  $\frac{3}{8}$ " high pillars.

All wiring for these two stages is done in 18 gauge tinned copper wire, with spaghetti sleeving where necessary. A strip of Polystyrene  $5\frac{3}{8}$ " long x  $15/16$ " high x  $\frac{1}{4}$ " thick is mounted on the rear edge and drilled to take the connections from power supply, etc. Two covers shield this section, a small one covering the oscillator and isolator sockets, shown in position in the illustration, and a larger cover, which covers the remaining components on the dural plate.

The 6U5G is mounted horizontally on top of this second cover and takes its grid input from the terminal strip, and its other connections from under the chassis of the main unit. Visible in the illustration is the white negative co-efficient Ceramicon which compensates against temperature drift, and is located in front of the main trimmer.

Across the chassis from left to right is the power transformer, rectifier, buffer output tank in its shield, with the buffer amplifier immediately in front, and the VR150/30 regulator at the extreme right. The three valve sockets on the right hand side are for the three stage pre-amp not yet wired.

The front illustration shows: top left, filaments and bias switch, corrector dial, main dial, and h.t. switch at the top right hand corner. Bottom row, key jack, automatic band switch (to be attempted later), v.f.o. note switch, phone-c.w. switch, speech amp. h.t. switch, speech gain control, and microphone jack. The filter chokes and send-receive relay are mounted under the chassis, the relay being rubber mounted.

Flexible earthing leads connect the dural plate carrying the first two stages to the main chassis, to ensure adequate ground.

### ADJUSTMENT

After wiring and testing, comes the all-important and generally neglected point of adjustment. First check the

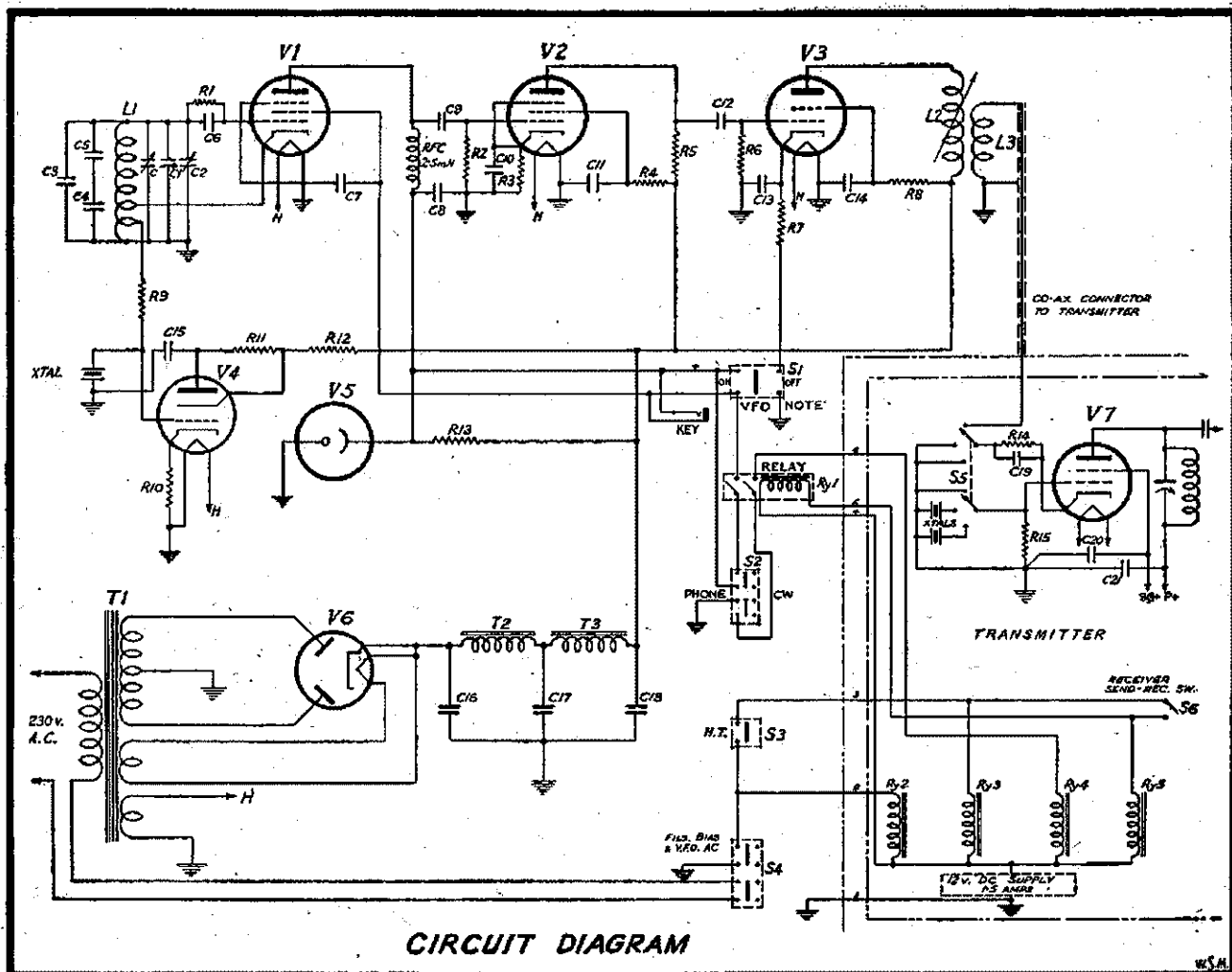

CIRCUIT DIAGRAM

- C1, C2—See text.  
 C—5-100 pfd. Hammuland trimmer.  
 C3—750 pfd. Simplex mica.  
 C4—100 pfd. N750 Ducon Ceramicon.  
 C5—200 pfd. Simplex mica padder (80 metre coil only).  
 C6—50 pfd. silvered mica.  
 C7—.002 mfd. mica.  
 C8—.0003 mfd. mica.  
 C9, C12—100 pfd. mica.  
 C10, 11, 13, 14, 15, 19, 20, 21—.01 mfd. mica.  
 C16, 17, 18—8 mfd. electrolytic.  
 R1, 9, 15—50,000 ohms.  
 R2, 4, 6—100,000 ohms.  
 R3, 7—250 ohms.  
 R5—5,000 ohms.  
 R8—40,000 ohms.  
 R10—10,000 ohms.

- R11—1 megohm.  
 R12—500,000 ohms.  
 R14—250 ohms.  
 R13—5,000 ohms, 20 watt.  
 S1—d.p.d.t. toggle switch.  
 S2, 4—Four way d.t. toggles.  
 S3, 6—s.p.s.t. toggles.  
 S5—Three position 2-pole rotary.  
 T1—Power transformer 300-0-300 v., 100 Ma., with 5 v. and 6.3 v. filament windings.  
 T2, 3—Filter chokes, 30 h., 100 Ma.  
 Ry1—d.p.s.t. d.c. 75 ohm relay.  
 Ry2—Filament and bias supply d.c. relay.  
 Ry3—h.t. supply d.c. relay.  
 Ry4—Mod. supply d.c. relay.  
 Ry5—Antenna relay.

- V1, 2—6SK7.  
 V3—6F6.  
 V4—6U5G.  
 V5—VR150/30.  
 V6—5V4G.  
 V7—6V6G.  
 L1—160 metre coil: 27½ turns 24 t.p.i., 25 b. and s. enamel, ¾" diam. Polystyrene, cathode tap 8 turns, xtal resonator tap 1 turn. 80 metre coil: 12½ turns 14 t.p.i. 20 s.w.g. tinned, ¾" diam. Polystyrene, cathode tap 4 turns, xtal resonator tap 1 turn.  
 L2—80 turns closewound 35 s.w.g. enamel, ¾" diam. Polystyrene.  
 L3—7 turns closewound 29 b. and s. enamel, spaced 1/16" below L2.

oscillator for covering the band and also check to see the electron eye is functioning correctly—the eye should be almost closed off resonance, and open to almost 90° at resonance.

**Voltage stabilisation of the Oscillator.**—Remove the VR150 regulator and connect a 10,000 ohm resistor in the common plate and screen h.t. lead to the oscillator. Wire a switch

across this resistance. Close the switch so that the resistor is out of circuit. Now with b.f.o. on the receiver in operation, zero beat to the e.c.o. output. Open the toggle switch across the resistor and retune the receiver to zero beat, noting whether the e.c.o. went higher or lower in frequency with a drop in h.t. voltage. If the frequency increased the cath-

ode tap on the oscillator is **too high**. If it has decreased in frequency the cathode tap is **too low**. Adjust the cathode tap accordingly until no audible change in beat note occurs.

With this simple method of voltage stabilisation the oscillator is made immune from frequency changes due to voltage variations up to 100 volts change. The voltage regulator was



on hand and was included to maintain the voltage at 150 volts, to enable the screen and plate supplies to be tied together, without exceeding the safe dissipation of the 6SK7 oscillator.

The oscillator coil which is wound on a  $\frac{3}{8}$ " diameter Polystyrene former should now be rewound with permanently connected taps, as altering cathode taps whilst adjusting mutilates the coil. The final winding was on a former threaded 14 turns per inch, consisting of 12½ turns of No. 22 gauge tinned copper wire. Where taps are required, at one turn, and approximately 4 turns, from the cold end of the coil, the wire is formed into a loop as shown in the small inset in Figure 1, and bound at the neck of the loop with a strand of tinned copper wire from a piece of Belden. This loop is then soldered and flattened on an anvil making a nice solder lug to solder the tap to.

The keying of the oscillator can now be checked and will be found to be clean and free from chirps, provided the circuit has been adhered to. Do not connect the isolator to the output of the voltage regulator, or raise the values of screen and plate bypasses on the oscillator, or chirps will occur. If you do not wish to key the oscillator, key in the buffer amplifier cathode, not in the isolator, or again you will have a chirpy note.

The whole unit can now be checked for output and drive to the transmitter, and if it is required to feed into an 80 metre crystal oscillator tube in the transmitter, such as a 6V6G, ground the grid of the crystal oscillator, and connect the cathode to the co-ax line of the v.f.o. Operating as a grounded grid amplifier the 6V6G is quite stable, and will easily drive an 807.

**Temperature compensation** is commenced now and use is made of the new Ceramicons made by Ducon. These condensers are white in colour, and resemble a resistor in appearance. The dielectric is a ceramic with the plates of silver, and by varying the degree of titanium dioxide, these condensers can be made to either increase or decrease in capacity with a rise in temperature. The negative co-efficient condensers have, in addition to the capacity, the designation N750, indicating that a reduction in capacity of 750 parts in one million will occur as the temperature of the condenser increases. These condensers also have a small green dot on one end. The zero co-efficient Ceramicons have N.P.O. and a black dot.

The method of temperature compensation is as follows:—

Firstly, the total lumped capacity of the oscillator is made up of ordinary mica condensers. The v.f.o. is then put in its case and switched on. After allowing about five minutes initial warm-up, to allow the oscillator tube to attain operating

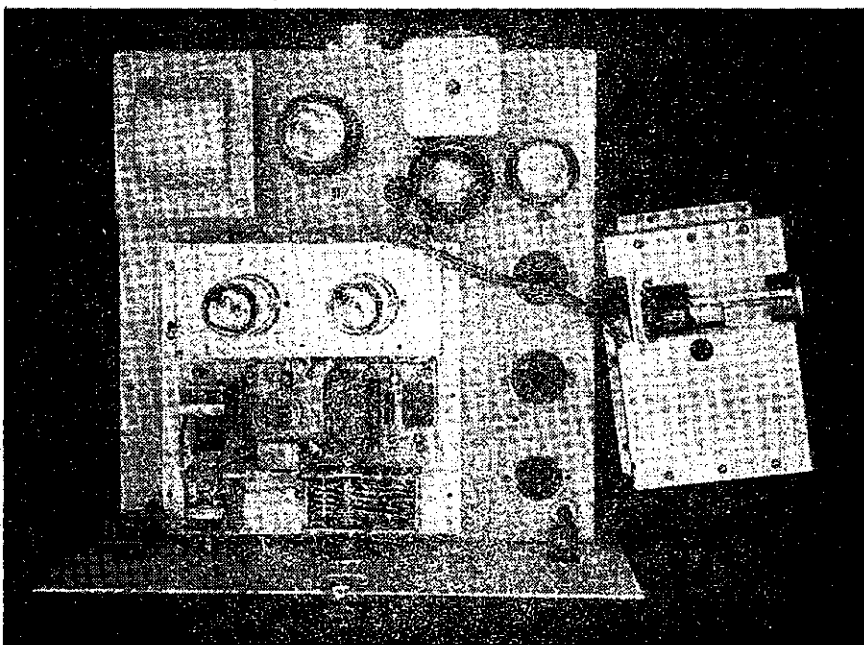

temperature, the v.f.o. is tuned to the crystal frequency, indicated by maximum opening of the eye. After running for about fifteen minutes, it will be found the eye has closed, so carefully retune the main dial to resonance, noting whether the main tuning condenser has to be increased or decreased in capacity, it will most certainly need decreasing, indicating an increase in capacity with a rise in temperature somewhere in the circuit. Connect the 100 pfd. N750 Ceramicon in circuit and remove 100 pfd. of ordinary mica condensers and try again. It will probably be found that the main condenser will need to be increased in capacity, indicating over compensation. Smaller values of Ceramicons should be used until exact compensation is attained. In the writer's case values under 100 pfd. were not obtainable, so it was necessary to introduce a series padder of ordinary mica, and by varying the value of this padder exact temperature compensation was obtained.

#### CALIBRATION

The celluloid dial is rubbed with fine glass paper to make it suitable for Indian ink, and two small holes are pricked in the two celluloid cursors. It is here that a 100 Kc. oscillator and 10 Kc. multi-vibrator is required. If you have an alignment oscillator which will cover 100 Kc. it will only be necessary to connect the multi-vibrator and an untuned output amplifier.

Alternatively an alignment oscillator on 500 Kc. and two multi-vibrators on 100 Kc. and 10 Kc. are needed, but unfortunately it is unnecessary to have, or make, a unit of this kind to calibrate successfully.

The 500 Kc. or 100 Kc. oscillator is tuned to zero beat with WWV on 5, 10 or 15 Mc., and resistor values of the multi-vibrator varied by means of the potentiometer until the beats between the 100 Kc. points are correct, that is nine points in between. The receiver is now tuned to the beat indicating exactly 7.2 Mc. and with the receiver b.f.o. on, the v.f.o. is tuned to zero beat also. Next tune the receiver to the beat note indicating 7.19 Mc., and again tune v.f.o. to zero beat, pointing the dial through the hole in the cursors at each step, and so on, until the range 7-7.2 Mc. is covered. The 3.5 and 7 Mc. scales will now have 5 Kc. and 10 Kc. points, respectively. Start again with the receiver at 14.4 Mc. and mark points every 10 Kc. from 14 to 14.4 Mc., at the same time marking the 28 Mc. scale, which will give 20 Kc. divisions. The dial is now inked in and figured, thereby completing the calibrations.

#### NOTE THESE POINTS

During the building and experimental work on this v.f.o., several faults occurred, which resulted in the note of the oscillator being unstable, and are noted here to illustrate the care that is necessary in building a unit of this kind.

(1) Reduction drive of main condenser touching the front panel. This trouble was eliminated by enlarging the hole in the front panel, and putting additional earth straps from the dural plate to the chassis, thereby bringing these parts to the same earth potential.

(2) Loosening the screws holding the rear cover plate over the oscillator and isolator sockets, caused in-

(Continued on Page 23)

# W.I.A. 1947 INTERNATIONAL DX CONTEST

**R. H. CUNNINGHAM, VK3ML,**

The 1947 Federal Convention of the W.I.A. directed the Federal Executive to organise and conduct a 1947 International DX Contest to be held over the four week-ends in October.

The co-operation of amateurs throughout the world is sought through their respective Radio Societies to ensure that the contest is successful not only from the stand point of VK stations but as a means of providing an interesting series of week ends for overseas stations.

This contest is similar in nature to those previously held and which were very familiar to the pre-war gang with the exception that allowance has been made this year for single band operation in addition to the "open" all band trials.

Both the open and single band sections are subject to awards and participants are only asked to endorse their logs with the particular section they are contesting.

It hardly seems necessary to have to explain the formulation of serial numbers, but, without this knowledge, some few Hams might miss the enjoyment of the contest, so here is

a brief resume of the method. Each participating station allots himself three figures, anything between 111 and 999. These figures form half the six-figure serial number that he hands over to the station he contacts. The other half, at the first QSO, consists of three noughts, 000. Therefore, for example, 453,000 may be a station's number that he passes on to his first contact. In exchange he will receive a similar number, say, 687,989, which shows that that station has worked another station before, because the three 000s have been substituted by 989. The second half of the six-figure serial number is taken from the first three figures of the number received at the previous QSO, and is added on to a station's own three figures. Then this combination is given to the next contact, and so on throughout the test. Always retaining the first three figures, adding the second and trans-

mitting them in that order.

The Executive of the W.I.A. invite amateurs all over the world to participate in this contest and can guarantee you some thrills—especially as the V.H.F.s. should be opening-up around this time of the year!

## RULES AND CONDITIONS

1. There shall be three contests:—
  - (a) Transmitting c.w.
  - (b) Transmitting phone.
  - (c) Receiving.
2. Contestants may compete in the "open" events, that is, on all licenced amateur bands, or in any one or more individual bands by submitting a log for each band. There shall be awards for the "open" as well as for the winners of each band.
3. The Wireless Institute of Australia Contest Committee shall be the sole adjudicators, and their rulings will be binding in the case of dispute.
4. The nature of the contest requires the world to contact all States of VK.
5. The contest is to be held from 0001 E.S.T. Saturday, 4th October, till 2359 E.S.T. Sunday, 5th October (from 1401 G.M.T. 3rd October, till 1359 G.M.T. 5th October) and will continue over the following three week-ends in October at the same times.
6. The first two week-ends are to be devoted to PHONE operation

## ELECTRICAL SPECIALS

**TRANPRO VALVE  
AND CIRCUIT TESTER  
MODEL 862.**

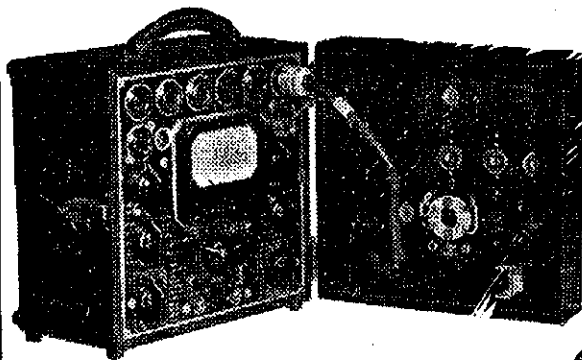

**Vealls Are Now Victorian Distributors of  
"TAYLOR" VALVES**

Type No. 866 J are now in Stock. Write to Vealls for further particulars.

**SOUTH OF THE YARRA HAMS.**

Keep on the beam by making our Prahran Store your Headquarters. Contact VK3FR (Fred Smith)

This compact and convenient tester will be found not only necessary to Radio Servicemen, but also to Radio experimenters.

Reads Milliamperes, D.C. and A.C. Volts, output volts and tests resistors, condensers and valves.

New model incorporating Button and Local sockets. Operates from 230 A.C. or 6 volt battery.

Cash Price £32/19/6 plus tax. Terms available.

**KINGSLEY**

KFT3 Kingsley Ferratone 4 Valve Kit Set  
Complete with cabinet £16/3/0 Retail.  
(Subject to usual HAM Discount)

# VEALLS

Mail  
Orders  
BOX 2141T

243 SWANSTON ST., MELBOURNE Telephone  
299 CHAPEL ST., PRAHRAN VK3145

whilst the latter two for C.W. The receiving contest is open at all times and incorporates both phone and c.w. reception.

7. The contest is open to all licenced transmitting amateurs and receiving stations in any part of the world. Unlicenced ship and expedition stations are not permitted to enter the contest. Financial members of the W.I.A. and its affiliated societies only will be eligible for awards in VK.

8. Only one licenced station is permitted to operate any one station under the owner's call sign. Should two or more operators operate any particular station, each will be considered a competitor and must enter his own call sign and submit, in his log, the contacts established by him. This debars persons from entering who have not a HAM licence.

9. Each entry must be signed by each competitor as a declaration of the above statement.

10. Each participant will assign himself a serial number of three figures, as detailed in the contest description. When two or more operators work the one station, each will assign himself a separate number.

11. All amateur frequency bands will be used.

12. Only one contact with a specific station on each of the bands during each week-end will be permitted.

13. Contacts may be repeated on each of the succeeding week-ends with the same stations in accordance with Rule 12.

14. Each contact must be accompanied with an exchange of serial numbers and signal strength reports, including readability, strength and tone.

15. The judges reserve the right to disqualify any station whose tone report is consistently less than T8.

16. Scoring. Three points will be allotted for every contact completed with an exchange of serial numbers and signal reports.

17. VK stations will multiply their total score by the number of countries worked on each band and stations outside Australia by the number of Districts worked on each band in Australia; there being eight in all: VK2, 3, 4, 5, 6, 7, 8, and 9. The onus of establishing the identity of new countries will rest with the participants.

18. No prior entry need be made for the contest, but each contestant is to submit a log at the conclusion of the test showing: date, time (in G.M.T.), band, station worked, in and out serial numbers, in and out signal strength reports, and points claimed for each QSO. Finally a summary of points and multipliers claimed must be shown at the conclusion of the log.

19. Entries from VK stations must reach the W.I.A., 191 Queen Street, Melbourne, C.I, Victoria, Australia, not later than 14 days after the conclusion of the contest and overseas logs should reach that address by 31st December, 1947.

20. Awards. Attractive certificates will be awarded to the station returning the highest total in each State of each participating Country. Special prizes, donated by our advertisers, will be awarded, in addition to certificates, to section winners in Australia. There will be no world winner.

21. Overseas stations should call CQ VK, and VK stations CQ DX TEST. It is especially requested that c.w. stations refrain from operating during the phone contest and likewise, the phone stations QRT during the c.w. trials.

#### RECEIVING

1. The rules for the receiving contest are the same as for the transmitting contest, but is open to members of any Short Wave Listeners' Society in the world. No transmitting station is allowed to compete in the receiving contest too.

2. Only one operator is permitted to operate only one receiver.

3. The dates, scoring of points, and logging of stations once on each band per week-end are subject to the same rules as for the transmitting contest.

4. To count for points, the call sign of the station being called, and the strength and tone of the calling station, together with the serial number and signal strength report sent by the calling station, must be entered on the log.

5. The above items must be filled in before points can be claimed, that is, it is not sufficient to log a station call-  
(Continued on page 21)

## TECHNICAL BOOK & MAGAZINE CO.

297-299 SWANSTON STREET, MELBOURNE

(Opposite Old Melbourne Hospital)

Central 2041, Melbourne, C.I

We can arrange subscriptions to any of the following magazines:

### AMERICAN.

RADIO: . . . . .	25/- year	COMMUNICATIONS: . . . . .	24/- year
Q.S.T.: . . . . .	27/- "	RADIO NEWS: . . . . .	40/- "
C.Q.: . . . . .	25/- "	RADIO CRAFT: . . . . .	22/- "
SERVICE: . . . . .	24/- "	SCIENCE DIGEST: . . . . .	23/6 "
F.M. & TELEVISION: . . . . .	48/- "	PROCEEDINGS INST. OF RADIO	
ELECTRONICS: . . . . .	97/6 "	ENGINEERS . . . . .	88/- "
SPECIAL RATE FOR THREE YEARS: . . . . .	195/- "	POPULAR SCIENCE: . . . . .	23/6 "
		POPULAR MECHANICS: . . . . .	23/6 "

### ENGLISH AND AUSTRALIAN.

WIRELESS WORLD: . . . . .	25/- year	WIRELESS ENGINEER: . . . . .	42/- year
PRACTICAL WIRELESS: . . . . .	13/6 "	ELECTRONIC ENGINEERING: . . . . .	33/- "
AUST. RADIO WORLD: . . . . .	10/6 "	RADIO AND HOBBIES: . . . . .	6/6 "
AMATEUR RADIO: . . . . .	6/- "	SHORTWAVE MAGAZINE (English): . . . . .	25/6 "

FOREMOST IN AUSTRALIA FOR TECHNICAL BOOKS.

# AUSTRALIAN DX CENTURY CLUB

We are pleased to announce that applications will now be received for membership of the Australian DX Century Club, in accordance with the Rules, which are set out hereunder.

## RULES

1. The Australian DX Century Club is open to Australian Amateurs only with confirmed Contacts with one hundred or more Countries.

2. All Contacts must be made with Amateur Stations working in the authorised Amateur Bands, or with other Stations licenced to work Amateurs.

3. In cases of Countries where Amateurs are licenced in the normal manner, credit may be claimed only for Contacts with Stations using regular Government-assigned Call Signs.

4. All Stations contacted must be "Land Stations," Contacts with Ships, anchored or otherwise, and Aircraft cannot be counted.

5. All Stations must be contacted from the same Australian Call Area, and by the same licensee. Contacts may be made from the same Call Area under different Call Signs, if the licensee is the same person.

6. The A.R.R.L. Countries List, as published from time to time in QST shall be used in determining what constitutes a Country.

7. Contacts, to count for eligibility in the Club, may be made at any time after the return of Australian Amateur licences following the end of the 1939-45 War.

8. A Certificate will be issued for Club membership, and Call Signs of members will be listed in "Amateur Radio." Listing will be in three Sections, "Phone," "C.W." and "Open," and the number of Countries will be shown against each member's Call Sign.

9. Following the first listing in "Amateur Radio," confirmation of additional Countries may be submit-

ted, but not less than five at a time, and the listing will be changed accordingly.

10. Confirmations, i.e. QSLs, must be submitted for all Countries claimed, exactly as received from the Stations worked. Altered or forged confirmations may result in the applicant being disqualified. Confirmations must be accompanied by a list of Countries and Stations claimed, to aid in checking and for future reference.

11. Applications for membership shall be addressed to the Secretary of the Division of the W.I.A. in the State in which the applicant resides, and shall be accompanied by the necessary Confirmations and List of Contacts as required by Rule 10, together with a sufficient remittance in postage stamps to cover return of the Confirmations by Registered Mail.

12. Applications and Confirmations shall be examined by an Officer of the Division, appointed for the purpose by the Council of the Division, who shall, if satisfied that the applicant is eligible for membership in accordance with these Rules, notify the Federal Traffic Manager of the Applicant's Name, Call Sign, Address and number of Countries confirmed. The Federal Traffic Manager shall in turn arrange for the listing of the necessary particulars in "Amateur Radio."

13. The decision of the Federal Traffic Manager shall be final and binding in respect of any matter pertaining to these Rules.

14. Notwithstanding Rule 13 above, these Rules may be amended from time to time by decision of the Federal Council of the W.I.A.

Brunei	VS5
Bulgaria	LZ
Burma	XZ
Cameroons, French	FE8
Canada	VE
Canal Zone	KZ5
Canary Islands	EA8
Cape Verde Islands	CR4
Caroline Islands	—
Cayman Islands	VP5
Celebes and Molucca Ids.	PK6
Ceylon	VS7
Chagos Islands	VQ8
Channel Islands	GC
Chile	CE
China	XU, C
Christmas Island	ZC3
Clipperton Island	—
Cocos Island	TI
Cocos Islands	ZC2
Colombia	HK
Comoro Islands	—
Cook Islands	ZK1
Corsica	—
Costa Rica	TI
Crete	SV
Cuba	CM, CO
Cyprus	ZC4
Czechoslovakia	OK
Denmark	OZ
Dodecanese Islands, e.g. Rhodes	SV5
Dominican Republic	HI
Easter Island	—
Ecuador	HC
Egypt	SU
Eire	EI
England	G
Eritrea	16
Ethiopia	ET
Faeroes, The	OY
Falkland Islands	VP8
Fanning Is. (Christmas Is.)	VR3
Fiji Islands	VR2
Finland	OH
Formosa	—
France	F
French Equatorial Africa	FQ8
French India	FN
French Indo-China	FI8
French Oceania, e.g. Tahiti	FO8
French West Africa	FF8
Fridtjof Nansen Land, (Franz Josef Land)	—
Galapagos Islands	—
Gambia	ZD3
Germany	D
Gibraltar	ZB2
Gilbert & Ellice Ids. and Ocean Island	VR1
Goa (Portuguese India)	CR8
Gold Coast (and British Togoland)	ZD4
Greece	SV
Greenland	OX
Guadeloupe	FG8
Guantanamo Bay	NY4
Guatemala	TG
Guiana, British	VP3
Guiana, Neth. (Surinam)	PZ
Guiana, French, and Inini	FY8
Guinea, Portuguese	CR5
Guinea, Spanish	—
Haiti	HH
Hawaiian Islands	KH6
Honduras	HR
Hong Kong	VS6
Hungary	HA

## THE A.R.R.L. LIST OF COUNTRIES

(From "QST" February 1947)

Aden and Socotra Island	VS9	Baker Is., Howland Is., & Am. Phoenix Islands	KB6
Afghanistan	YA	Balearic Islands	EA6
Alaska	KL7	Barbados	VP6
Albania	ZA	Basutoland	ZS4
Aldabra Islands	—	Bechuanaland	—
Algeria	FA	Belgian Congo	OQ
Andaman Ids. & Nicobar Ids.	—	Belgium	ON
Andorra	PX	Bermuda Islands	VP9
Anglo-Egyptian Sudan	ST	Bhutan	—
Angola	CR6	Bolivia	CP
Argentina	LU	Bonin Ids., & Volcano Ids., e.g. Iwo Jima	—
Ascension Island	ZD8	Borneo, British North	VS4
Australia	VK	Borneo, Netherlands	PK5
Austria	OE	Brazil	PY
Azores Islands	CT2	British Honduras	VP1
Bahama Islands	VP7		
Bahrein Island	VU7		

# A.G. HEALING

LIMITED

MANUFACTURERS AND  
DISTRIBUTORS FOR . . . . .

Electrical and Testing Instruments for all purposes made to British Standard specifications. Each instrument is accurate, + or —, to 2 per cent., and parts are heavily plated to prevent corrosion even under tropical conditions. "Healing" Electrical Meters equal the best imported types and will give accurate service for long periods under the most exacting conditions.

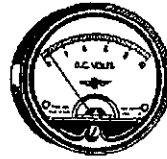

No. 10A round production mounting Black Bakelite Case.

Type No. 30A 4" square semi-flush Black Bakelite Case.

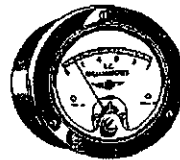
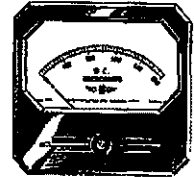

No. 20A 2½" round flush mounting Black Bakelite Case.

These, and all other Healing Radio Electrical Testing Units, are manufactured in our own factories and available from A. G. Healing Ltd.

OTHER INSTRUMENTS INCLUDE:

Oscillators — Multi-Testers — Signal Tracers, etc.

ALSO MANUFACTURERS AND DISTRIBUTORS FOR

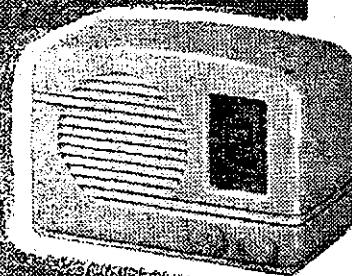

## Golden Voice RADIO

A. G. HEALING LTD. MELBOURNE, SYDNEY, ADELAIDE

Iceland	TF
Ifni	—
India	VU
Iran	EP, EQ
Iraq	YI
Ireland, Northern	GI
Italy	I
Jamaica	VP5
Jan Mayen Island	—
Japan	J
Jarvis Island, Palmyra Group, (Christmas Is.)	KP6
Java	PK
Johnston Island	KJ6
Kenya	VQ4
Kerguelen Islands	—
Korea	—
Kuwait	—
Laccadive Islands	VU4
Leeward Islands	VP2
Liberia	EL
Libya	LI
Liechtenstein	HE1
Little America	KC4
Luxembourg	LX
Macau	CR9
Madagascar	FB8
Madeira Islands	CT3
Malaya	VS1, VS2
Maldiv Islands	—
Malta	ZB1
Manchuria	—
Marianas Islands (Guam)	KG6
Marshall Islands	—
Martinique	FM8
Mauritius	VQ8
Mexico	XE
Midway Island	KM6
Miquelon and St. Pierre Ids.	FP8
Monaco	—
Mongolia	—
Morocco, French	CN
Morocco, Spanish	EA9
Mozambique	CR7
Nepal	—
Netherlands	PA
Neth. West Indies	PJ
New Caladonia	FK8
Newfoundland and Labrador	VO
New Guinea, Neth.	PK6
New Guinea, Territory	VK9
New Hebrides	FU8, YJ
New Zealand	ZL
Nicaragua	YN
Nigeria	ZD2
Niue	ZK2
Norway	LA
Nyasaland	ZD6
Oman	—
Palau Islands	—
Palestine	ZC6
Panama	HP
Papua	VK4
Paraguay	ZP
Peru	OA
Phillipine Islands	KA
Phoenix Islands, British	—
Pitcairn Island	VR6
Poland	SP
Portugal	CT
Principe and Sao Thome Ids.	—
Puerto Rico	KP4
Reunion Island	FR8
Rhodesia, Northern	VQ2
Rhodesia, Southern	ZE
Rio de Oro	—
Roumania	YR

Ryukyu Islands, e.g. Okinawa	—
St. Helena	ZD7
Salvador	YS
Samoa, American	KS6
Samoa, Western	ZM
Sarawak	VS5
Sardinia	—
Saudi Arabia (Hedjaz & Nejd)	HZ
Scotland	GM
Seychelles	VQ9
Siam (Thailand)	HS
Sierra Leone	ZD1
Sikkim	AC3
Solomon Islands	VR4
Somaliland, British	VQ6
Somaliland, French	FL8
Somaliland, Italian	—
South Georgia	VP8
South Orkney Islands	VP8
South Sandwich Islands	VP8
South Shetland Islands	VP8
Southwest Africa	ZS3
Soviet Union:—	—
European Russian Soc.	—
Fed. Sov. Rep.	UA1-3-4-6
Asiatic Russian S.F.S.R.	UA9-0
Ukraine	UB5
White Russian S.S.R.	UC5
Azerbaijan	UD6
Georgia	UF6
Armenia	UG6
Turkoman	UH8
Uzbek	UI8
Tadzhik	UJ8
Kazakh	UL7
Kirghiz	UM8
Karelo-Finnish Rep.	UNI
Moldavia	UO5
Lithuania	UP
Latvia	UQ
Estonia	UR
Spain	EA
Sumatra	PK4
Svalbard (Spitzbergen)	—
Swan Island	KS4
Swaziland	—
Sweden	SM
Switzerland	HB
Syria	AR
Tanganyika Territory	VQ3
Tangier Zone	EK
Tannu Tuva	—
Tibet	AC4
Timor, Portuguese	CR10
Togoland, French	FD8
Tokelau (Union) Islands	—
Tonga (Friendly) Islands	VR5
Trans-Jordan	ZC1
Trieste	—
Trinidad and Tobago	VP4
Tristan da Cunha and Gough Is.	ZD9
Tunisia	FT4
Turkey	TA
Turks and Caicos Islands	VP5
Uganda	VQ5
Union of South Africa	ZS
U.S.A.	W, K
Uruguay	CX
Venezuela	YV
Virgin Islands	KV4
Wake Island	KW6
Wales	GW
Windward Islands	VP2
Wrangel Islands	—
Yemen	—
Yugoslavia	YT, YU
Zanzibar	VQ1

## SUCH NICE PEOPLE

By "GREMLIN"

Got a nasty chip on my shoulder. Those unlicensed, misguided individuals who use our bands and our call signs for their pleasure, cluttering up our limited space with their playthings, put it there. In polite conversation we call them "pirates."

In scanning the daily paper have not noticed many prosecutions against these imposters, although we have been getting our share of publicity, haven't we? I thought that cunning box of tricks, nicely portrayed in a daily, apparently possessing the clairvoyant power of detecting the unlicensed BCL, would have found the pirate a push-over. Apparently no. Why not? Maybe these pirates are cunning lads—they say rats are. Maybe that box of tricks must rest sometimes, or maybe you and I just growl about the fungus on our hobby and leave it at that. Was it a Ham who inspired some gent to say we British are a far too tolerant race?

The time has come for us—in the words of the classics—to get really stuck into these pirates and track them to their lairs. After all, we have the best opportunities for recognising these individuals and that is probably half the battle. An up to date call book would also help. If you know a pirate, point the finger at him—or get him to pass that simple examination I read about!

Some will probably say, where do we start? I don't know, maybe the disposal joints, but I do say, let's get organised and protect our domain. So, into battle Hams, and when you see a piratical head, kick it!

Now for the meat—or as some prefer—tripe, ever remembering, "no hand-claps for VK3 and kicks for VK2." Sorry I can't be diplomatic, wasn't born that way.

To 2GH (Chas.) goes the prize of the rottenest sig to date, never to be regained, I hope. Boy, what a note. The "T" system was never designed to cope with your effort spreading over 75 Kc. of the 7 Mc. band. I heartily agree with Phil (2GS) who suggested it sounded like a TNT and to try it out on a dummy aerial before turning it loose on the mob again. Was I surprised, Phil, when you got a full QTH in reply to your query? I guess our thoughts were on similar lines. Let's hope Chas does not drop the odd dit and point the bone at you Phil!

Talking of dits, 5HN flings them around with gay abandon when finagling that bug.

(Continued on Page 24)

## FEDERAL NOTES.

# I.A.R.U. CALENDER NEWS EXCERPTS

The 1947 International Telecommunications Conference opened in Atlantic City, New Jersey, U.S.A., on 16th May last, at which about 70 countries and independent colonies are represented by about 600 attendants. The tremendous task of revising the world's radio regulations, complicated by the many war-born strides in techniques, the development of many new services needing frequencies, and the fact that no conference has been held for nearly ten years, is well recognised by the delegates. The conference therefore decided to set up ten committees to deal with the many matters requiring attention.

Obviously the most important to us—indeed to all the conference—is the committee on allocations, headed by Colonel Sir Stanley Angwin, Chairman of the United Kingdom delegation, who was the leader of this work at Madrid, Cairo and Moscow. You will be interested in a summary of the original proposals by the various nations as they affect present or proposed amateur frequencies:—

Australia.—3.5-3.8, 7-7.2, 14-14.4, 21.1-21.5, 28-30, 50-54, 166-170, and higher bands beginning at 1215 Mc.

Canada.—Same as U.S.A., below.

Chile.—(In a limited proposal covering 2-6 Mc.) 3.5-3.75 Mc.

China.—3.5-4, 7-7.3, 14-14.4, 21-21.5, 28-29.7, 50-54, 144-148, 220-225, 385-414, and higher bands beginning at 1215 Mc.

Czechoslovakia.—A limited proposal, but indicating 7.1-7.3 for broadcasting, and a V.H.F. allocation allowing but little for the amateurs.

Denmark (with Iceland, Norway and Sweden).—1.715-2 (shared, 10 watt limit), 3.5-3.6 Mc., proposal ends at 4 Mc. but indicates that 7.2-7.3 should go to broadcasting.

Ecuador.—Proposes retention of all Cairo amateur bands, plus 21-21.5 Mc. and a 27 Mc. band on a world-wide basis.

Egypt.—100 Kc. at 7 Mc., 250 Kc. at 14 Mc., 500 Kc. at 21 Mc., nothing else below 25 Mc.

France.—3.5-3.6, 7-7.15, 14-14.4, 21.1-21.45, 28-29.7, 70-71, 144-148 shared, 420-460 shared, and higher bands beginning at 1215 Mc.

India.—1.715-2 Mc. (shared, 10 watts limit); no indication of intentions as to other bands.

Ireland.—No indication of amateur intentions except back Loran in the 1.8 Mc. region.

Netherlands.—3.5-3.7, 7-7.15, 14-14.4, 21.25-21.45 and 28-29.7 Mc.

Netherlands Indies.—No indication of amateur intentions, except 7.2-7.3 Mc. for broadcasting.

Rumania.—3.5-3.7, 7-7.3, 14-14.4, 21-21.5 Mc.; proposals end at 23.8 Mc.

Soviet Union.—3.5-3.9 (shared), 7-7.15, 14-14.4, 21.1-21.5, 28-29.7, 70-72.8, 174-178, and higher bands beginning at 1145 Mc.

Switzerland.—1.925-2, 3.65-3.95, 7-7.2, 14-14.4, 21-21.45, 28-30 Mc.

United Kingdom.—1.715-2 (shared, 10 watts limit), 3.5-3.6, 7-7.2, 14-14.4, 21.25-21.45, 28-29.7, 166-168, 400-415 (shared), and higher bands beginning at 1215 Mc.

United States.—3.5-4, 7-7.3, 14-14.4, 21-21.5, 28-29.7, 50-54, 144-148, 220-225, 420-450, and higher bands beginning at 1215 Mc.

Venezuela.—1.8-2 (shared), 3.5-4, 7-7.3, 14-14.4, 21-21.5, 28-29.99 Mc.

It is painfully evident from this tabulation that there is a great deal of initial pressure on the Cairo amateur bands. While there has been no actual decision as yet the following is the complexion of things with respect to the amateur service, in the 2.85 to 25 Mc. region, emphasising that the discussions are STILL in their preliminary phases.

The 3.5 Mc. band is very likely to suffer a reduction in the European region, as is indicated by the proposals of those nations. Present suggestions vary from an exclusive band of 100 Kc. to a mixed-shared band of about 300 Kc. The 3.5 Mc. band will be available in the Americas in its Cairo width of 3.5-4 Mc. only if a regional agreement is possible, as seems likely.

The 7 Mc. band is causing us the greatest concern. Practically all the nations of North and South America propose a 300 Kc. band, but Australia, India, the Scandanavian countries and the United Kingdom insist on only 200 Kc., the remainder to be broadcasting exclusively; France and the Soviet Union are firm in their proposals of 150 Kc. for amateurs, the remainder for broadcasting exclusively. While the top 100 Kc., of this band has not been particularly useful for amateurs outside the Americas since Cairo, it may be that a further cut in the European region will be made so that broadcasting can have more space, and the change may even affect the Americas if the Governments on this hemisphere do not insist upon a regional allocation as at Cairo.

So far, as is again evident from proposals, there is general agreement to a figure of 400 Kc. on our 14 Mc. band. We expect the Cairo allocation to be continued.

There has been a surprising amount of support for a new band of frequencies for the amateurs at 21 Mc.,

so much so that at this point sincere appreciation is expressed to the officers of the various member societies (of which the W.I.A. is one—Ed.) who obviously have contributed much to Government thinking with respect to the new band. While the end result may not furnish the full 500 Kc. width, it seems certain that we shall get some new frequencies at 21 Mc., the tentative figure at the moment being 450 Kc.

From proposals it is evident that there is general agreement, so far, in 28-29.7 Mc., which we may expect as exclusively amateur. In the higher frequencies, there are great differences in the proposals and we cannot safely make any estimate of the probabilities beyond saying that we may expect to obtain a small share of the range above 30 Mc.

It is advised that by unanimous vote of all member societies, the Union Beige des Amateurs-Emetteurs (U.B.A.) has been admitted as a member of I.A.R.U. Also applications have been made by the Chinese Amateur Radio League (C.A.R.L.), China; Radio Club de Chile and Radio Club Paraguayo.

Following the approval of all European Societies the Netherlands (V.E.R.O.N.) is to proceed to inaugurate the first combined DX contest rather than a number of small individual contests.

## AMENDMENTS TO REGULATIONS

Federal Executive have been negotiating with the Department for some time with the view to having some of the restrictions in the present regulations removed. Some of these restrictions have already been deleted, and further privileges announced. The most recent of these are (1) the abolition of the six months probationary period and (2) the use of frequency modulation and pulse transmission on certain frequencies. The following frequencies are available for use of frequency modulation:—27.187-27.455 Mc., 50-54 Mc. Both frequency modulation and pulse transmissions are permitted on 166-170 Mc., 1345-1425 Mc., and other amateur bands to 10,000 Mc.

## NEW APPOINTMENTS

New South Wales Division.—Traffic Manager: VK2ARE, R. A. Egan.

Tasmanian Division.—V.H.F. Officer: VK7CW, C. A. Walsh; Publicity and Sub-Editor of "A.R.": VK7YY Watson.

Mr. J. MacIntosh (VS2AA) would be extremely grateful to receive replacement of cards which the Japanese looted. The two call signs affected are VS2AF and VS1AA and the period is 1934 to 1939. Mr. MacIntosh will be delighted to receive a card confirming any of his old con-Intosh, Postal Dept., Kaula Lumpur, tacts. The address is Mr. J. Mac-Malaya.

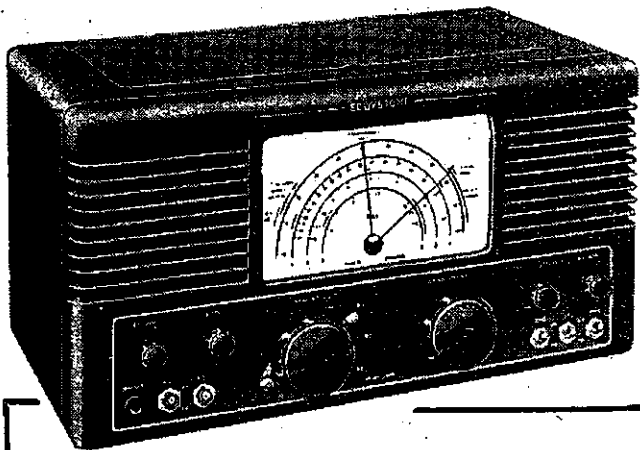

## EDDYSTONE AMATEUR BANDS COMMUNICATIONS RECEIVER MODEL 604

### MAIN TECHNICAL FEATURES

1. Receiver has been designed primarily for Amateur Communication purposes, tuning range from 31 Mc/s to 1.7 Mc/s.
2. Designed to operate from Standard AC Mains with Inputs of 110 volts 200/240 volts; 40/60 cycles as well as from a 6 volt battery by the use of a separate vibrator unit.
3. Inclusive all valves, the "640" is a 9-valve job with one tuned RF stage, FC, two IF stages, detector-AVC-1st audio, 2nd audio output, noise limiter, BFO and rectifier. The valves used, in that order are EF39, 6K8, EF39, EF39, 6Q7, 6V6, EB34, EF39, and 6X5. These are all international octal based on the Mullard or Brimar versions and are therefore easily replaceable.
4. INPUT IMPEDANCE—400 ohms.
5. TUNING RANGE—
  - (1) 31 to 12.5 Mc/s.
  - (2) 12.5 to 5 Mc/s.
  - (3) 5 to 1.7 Mc/s.
6. TUNING. An electrical band-spread arrangement is used for this purpose. Fly-wheel control is utilised on the band-spread condenser drive. The scale is clearly marked with all amateur bands, and is so arranged to enable accurate re-setting to a spot frequency.
7. I.F. FREQUENCY—1600 Kc/s.
8. CRYSTAL FILTER is vacuum mounted to provide a high degree of stability. Phasing control and "in/out" switch are brought out to the front panel.
9. Sensitivity is better than 2 microvolts input, for 50 milliwatts output, at all frequencies.
10. OUTPUT. Audio frequency output exceeds 3.5 watts.
11. "S" METER. A socket is provided for an external "S" Meter.

# This is it! the "640"

## ALREADY ACCLAIMED IN ENGLAND AS THE FINEST 'HAM' SET YET DESIGNED

### ● READ THESE TRIBUTES ... FROM THE "G's" OVERSEAS

● "Your claims are fully justified, the performance being excellent in every way. The outstanding feature is of course the Wonderful signal to noise ratio, and this, together with its excellent sensitivity, should satisfy the most confirmed critic.

On the 10 metre band I have compared received signals using the "640" and a 3 element beam, with the same received signal of other stations using 3 element beams, time and time again (hence the delay in sending my report), and I have proved to my satisfaction that the "640" has the advantage, taking an average over a large number of contacts, which practical report you will probably appreciate more than most laboratory reports. The excellent signal to noise ratio of the "640" has enabled me to carry through a QSO which, with my previous Station receiver, would not have been completed, under similar conditions. I have spent quite a lot of time on these comparative checks, and have proved these points conclusively.

The noise limiter is extremely effective, as is the crystal filter. In conclusion, I state that the "640" is a really fine job, which fills a long felt want for a standard British Amateur Communications Receiver, which will have my hearty support, and I hope that this is the first of a new series of Amateur Instruments by Eddystone.

I might add that the "640" is now my own station receiver, and I'm rather fussy."

● "It proves it to be a most remarkable receiver and you are to be congratulated on producing such an outstanding 'Ham' set, and we wish you every success in this market."

● "Having fully tested the model "640", it fully comes up to the standards required for a Communications receiver of this nature, especially on the 'Ham' bands we were able to separate stations working almost on top of each other.

The signal to noise ratio is extremely good. We have great hopes for this set during the coming season. You are to be warmly congratulated on the production of a very fine model."

● "The "640" was tried out over the week-end by our Mr. W. and J. B., an ex-Merchant Navy Radio Officer of some ten years operational experience. The latter was delighted with the sharp and clear C.W. note obtained by this receiver. We compared general sensitivity, selectivity and ease of control with two highly rated USA RX. "640" compared more than favourably with either model. Noise level for a given signal in fact was much lower in either case and the measured carriers of very weak signals were in several instances slightly superior on the "640". The appearance is really a fine job and altogether we feel that if this set was exported even to the USA it would readily find enthusiasts who still believe we in Britain can produce the goods without a lot of unnecessary trimmings and yet efficient and exacting standards."

These are extracts from just a few of the numerous congratulatory letters received by the makers of the "640."

**THIS FINE SET IS ON THE WAY . . . BUT SUPPLIES WILL BE LIMITED  
SO . . . PLACE YOUR ORDER NOW WITH YOUR AUTHORISED DISTRIBUTOR**

Australian Factory Representatives:

**KEITH HARRIS & CO. PTY. LTD. 51 William St., Melb. - - - Phone MB 2119**



## FEDERAL QSL BUREAU

RAY JONES, VK3RJ, MANAGER

The Postmaster General's Department advises that the second issue of the list of Experimental Stations in Australia, Papua and New Guinea will be on issue approximately 15th August. The Department intends to issue quarterly supplements and the new issue will also contain the first supplement. The price of the list (supplements included) remains at two shillings per annum.

The P.M.G. Department also announces that the policy of issuing VK4 call signs to experimental stations in Papua and New Guinea has been reversed. From 1st June stations in Papua and New Guinea have been issued with VK9 call signs. Up to the moment of writing approximately 15 licences had been issued. The list of VK9 stations will appear in the new list mentioned in the first paragraph of these notes.

The Department states that pre-war call signs that have been held awaiting the application of pre-war owners, are now available for general issue and are being allotted new licencees and applicants.

An interesting description of the purpose and apparatus at OIX7 (Finland) has just come to hand. The station which was designed and operated by pre-war OH2NM belongs to the Finnish Broadcasting Com-

pany and was installed to compile data on reception at regions where the normal Finnish Shortwave stations were being poorly received. OIX7 had an input power to the final of 600 watts. The line up is as follows 6V6G c.o. on 7 Mc., two 807 doubling stages to 28 Mc., 814 buffer amplifier and two Amperex HF300s final. The antennas used were of the Lazy H type and gave excellent results with practically worldwide contacts. Contact with VK and ZL was the most difficult as signals from VK and ZL were very weak in Finland during the spring of 1947.

G5UB/P (Jim Wetherill) has again left these shores after a short stay in Melbourne and a longer, and equally as pleasant, stay in Sydney. He can be contacted on most bands on his trip back to Vancouver. His QTH in Vancouver is 4910 East Hastings St., Vancouver.

Due to a typographical error in these notes in June "A.R." the A.P.O. number of the new J QSL Bureau was given as 800. The correct address is repeated: Major Lloyd Colvin, 71st Sig Ser. Bn., APO500, U.S. Forces, Japan.

Len Burston (ex-VK3BV I think) is operating a station with the forces in Japan under the call sign J4AAD. Len says Japanese printing is so bad that he has been forced to send to Australia for decent cards.

G. Warner (VK3ABW) has now moved on to Port Moresby and oper-

ating under the call sign of VK9GW. His QTH is care Overseas Tele Communications, Port Moresby, Papua. Quite a change of climate from Ballan, Victoria, I should think. I am endeavouring to persuade him to accept the appointment of QSL Manager for VK9, but no reply so far.

The R.E.F. advises of an International Scout Jamboree to be held in France from 4th to 25th August and desires prompt advice of any intending visitors from Australia. That is the best my meagre knowledge of the French lingo can extract from the letter.

Dr. Jose Polak (XE1SE), of Mexico, D.F., at considerable expense airmailed a number of sarapes to stations in Australia with whom he had phone contacts. The customs' notifications, etc., arrived in advance of the sarapes and caused quite a little speculation among the custom officials and also myself. We could not ascertain whether you ate them, wore them, or took them to bed with you. However they proved to be highly ornamental hand-woven affairs about 14" x 8", with a silk fringe at either end and were of bright and variegated colors. In the centre was woven in large letters, the call sign of the recipient. They probably are intended to be slung over the left shoulder at hamfests, etc., but methinks they would find better and more frequent use as a table runner. The Customs Department

**"ALL-ROUND" EFFICIENCY**

**TRIMAX TRANSFORMERS**

TYPE 2 UNO  
TA17 457  
MAX. W. 1000W  
UNBALANCED FULL  
TRIMAX TRANSFORMERS  
MELBOURNE

CS 6 67  
CS CFS  
TRIMAX TRANSFORMERS  
MELBOURNE

Available in Line to Grid, Plate to Line, Interstage — Single and Push-Pull types, Trimox Transformers are constructed of the finest materials and feature high Permeability, Nickel Iron Alloy core—heat treated in our own factory for Optimum results.

Also for Amplifier enthusiasts  
Standard or Custom built  
Chassis, Speaker Flares, Power  
Transformers, Microphone  
Stands, Filter Chokes, etc.

**TRIMAX TRANSFORMERS**

(Division of Cliff & Swirling Pty. Ltd.)

29-35 FLEMINGTON RD., NORTH MELBOURNE

graciously forewent any duty on the consignment. Trust the recipients have received them safely and acknowledged the gift.

Here you are philatelists—OZ7NJ, Jorgen Nielsen, 7 Falkonervaenget, Copenhagen, V. Denmark. States he is "very urgent stamp collector."

The following was copied from W1AW towards end of June:—"The Radio Operator of LI2B expedition Kon Tiki advises that excellent co-operation is being received from amateurs in relaying traffic from the raft to points in the U.S.A. To avoid interference it is requested that amateurs who wish to call wait until LI2B is clear of traffic. LI2B will CQ at 1200 GCT for 14 Mc. contacts.

"The Ro— antarctic expedition is operating from land base on 14 Mc. phone and c.w. using the call W3LYK/Antarctica. Traffic may be routed to the expedition via the REBEL and PELICAN nets on 7160 Kc."

Bill Wright, of South Plympton, S.A., a listener, goes in for the game properly. Bill had a lot of signals experience in the R.A.A.F. and often wonders why he doesn't lift out a call sign. Uses a Philips receiver with converter ahead for some frequencies and has a nice three element rotary which is doing its stuff in no mean style. Also owns an AR8 and a decent frequency meter.

Up bobs Eric Trebilcock again and still at Wynyard, Tasmania, helping himself to a large share of receiver DX. Has now heard 156 countries and confirmations from 81. Quotes he heard W4FU stating that his station had contacted 160 post-war countries. These Ws must dream up new ones. Eric has heard the following countries on 7 Mc. during June: G, OK, D, OE, GM, PA, LI, UA, UB, SM, HB, KM6, VR2, KL7, W, ZL, I, ON, and ET. As Eric says there's still DX to be had on 7 Mc. for those who care to listen. Thanks for your helpful and informative notes Eric.

The VK3 QSL Manager, Graham Roper, VK3ZB, 26 Lucas St., Caulfield, S.E.8, Victoria, would be grateful if stations not attending the monthly hand-out, and who are not country W.I.A. members, would send a large stamped addressed envelope.

## DIVISIONAL NOTES

### NEW SOUTH WALES

Secretary: Peter H. Adams, VK2JX  
Box 1734 G.P.O., Sydney.

Meeting Place: Science House, Gloucester and Essex Streets.

Meeting Night: Fourth Friday of each month.

The usual large attendance was present at the monthly general meeting held on Friday, 27th June. After the large crowd milling around the QSL officer, Jim Corbin (2YC), had been persuaded to take their seats, the chairman, Morrie Myers (2VN), opened the meeting. A warm welcome was extended to G5UB-VE7ALG, yet another Ham operating mobile marine, who met with a ready response to his request for "skeds," particularly on 54 Mc.

During general business, the Membership Secretary gave notice of his intention to move, at the July meeting, that the Articles of the Institute be amended to allow of up to one thousand members in the N.S.W. Division. The present limit, five hundred, has almost been reached. This augurs well for the future of the Division.

Honorary Life Membership was extended to Messrs. Bill Moore (2HZ) and Bill Zech (2ACP) for their services to the Institute.

The main business of the meeting was a lecture by Mr. Neville Williams (2XV), whose talk on "Rectifiers and Power Supplies," was listened to with keen interest. At the conclusion of his lecture, Mr. Williams replied to numerous questions and received an enthusiastic vote of thanks.

Don't forget those articles for "Amateur Radio." Send yours to the Technical Officer, N.S.W. Division. It may win for you the £1/1/- prize.

### NORTH COAST AND THE TABLELANDS

2ADN on 7 Mc. phone again after an absence of several years. — 2AHI has clipper and filter circuits in his modulators and uses only seven watts input to a sloping V. —

2SL occasionally on 7 Mc. phone, would like to return to 3.5 Mc. but power leaks too vicious. — 2WQ is QRL with new rig, should be on shortly. — 2NY also QRL with new receiver. Works some nice DX. — 2SH has been on holidays and visited several Hams around Orange, Bathurst and Sydney.

2GH, new Ham at Kemsey, puts a nice signal on 7 Mc. — 2DS recently received call sign; QRL with gear. — 2WC is generally heard on 14 Mc. using 807 p.a. to a co-ax fed doublet; new gear under way. — 2JK another new call at Coff's Harbour, on 7 Mc. and will soon run 50 Mc. tests with 2PA. — 2PA's activities are limited until new home is completed. Has new lazy H antenna on Europe. 50 Mc. receiver completed, transmitter under way. — 2XO, "Garden of Eden" inactive due to sickness, sends 73 to all the gang. — 2RK on 7 and 14 Mc. with v.f.o. An 807 feeds centre fed zepp. — 2ADE reports good DX. Post-war total now 137 countries, experimenting with clipper and filter circuits. Please send your notes to Zone Officer Bob Gream (2AFP) at Casino.

### NEWCASTLE ZONE

2BZ has a new 14 and 28 Mc. beam on 36 foot telegraph pole ready to go up, when the local gang supply the necessary push. — 2AHA very pleased with 100 countries post-war, uses twin 28 and 14 Mc. beam. — 2PQ a new Ham with a fine xtal signal getting to W and G with 25 watts. — 2AGD puts remarkable signals into ZS and G with a unique five element beam. — 2CS has the receiver built and the transmitter is about to receive attention. — 2KB enjoys a good rag-chew on 14 Mc. and makes a pleasure out of Ham Radio. — 2UF has broken the long silence, back on 28 Mc. with nice phone. — 2AMM now a poor married man so we may hear him on again sometime. — 2FP still chasing DX on 28 Mc. phone; 74 countries up with 35 watts. — 2CI has nice quality phone on 14 Mc. — 2ZC heard on 14 Mc. c.w., giving the phone a rest. — 2AGY heard frequently on 14 Mc. phone. Please send your notes to Ernie Baker (2FP), Hamilton.

## John Martin Electrical & Radio Co.

"MELBOURNE HOUSE," 360 POST OFFICE PLACE, CITY  
(Also 116 Clarence Street, Sydney)

Distributors—Aegis Kits, Components, University Test Equipment, Diamond Batteries,  
Erma Automatic Wire Strippers.

Contact us for your every requirement of Radio and Electrical Spares

- Role Speakers.
- IRC Resistors.
- Simplex Condensers.
- Potentiometers.
- Chokes.
- Speaker Transformers.
- Power Transformers.
- Radiotron Valves.

COMING—ENGLISH RAYMART CONDENSERS.

For Friendly and Satisfying Service, Telephone FJ 4052, MU 5423.

### COALFIELDS ZONE

The gang has not been as active; conditions a little patchier than usual. Yanks have been heard calling 2YO but no sign of George. — 2XT can be found on 7 Mc. most week-ends. — 2KZ is a 28 Mc. man except for an occasional excursion to 27 Mc., talks of winding 14 Mc. coils. — 2MK is mainly on 28 Mc. and talks of trying 50 Mc. — 2ADT very QRL during last month. Has 70 countries on 28 Mc. phone. — 2PZ still to be found on 7 Mc. phone. — 2YL still busy and little activity. Please send your notes along to Harry Hawkins (2YL) in Cessnock.

### WESTERN ZONE

2EL is located in a fowl shed at Narromine. Has 33 countries up and W.A.C. in four hours with an 807 in the final. — 2NS has a two element rotary up, results to date not too good. — 2II had a little modulator trouble now f.b. — 2AMR heard on 7 Mc. using old rig; phone very good. — 2WH had a little modulator trouble in the AT20; reports DX very good. — 2BT heard on phone, sounds like a No. 11. Believe another rig under way. — 2JC on 3.5 Mc. with really fine phone. — 2ACU and 2DO seem to be in trouble with antenna, hum, motors in wells, etc. — 2AP, late of Parkes, and his XYL (ex-VK2YW) were home in Richmond on leave. — Glad to

hear 2KR is on the mend after his accident. — If any of the western gang have any news please send it along to Jack Russell (2QA) of Nyngan.

### SOUTHERN ZONE

2EU had some trouble with lack of audio in the modulators; re-built amplifier with improved results. — 2APW building v.f.o. using 6SK7, 6F6, 6F6 with satisfactory results, next job is a heterodyne frequency meter. — 2GG and 2OJ still working on receivers, leaving little time for activity. — 2ANQ progressing slowly with his rig. — 2VK having a few contacts on 7 Mc. c.w. — Send your notes to Noel Arnold (2OJ) Albury.

## VICTORIA

Secretary: A. B. D. Evans, VK3VQ, Box 2611 W.G.P.O., Melbourne.

Meeting Night: First Wednesday of each month.

Meeting Place: Radio School, Melbourne Technical College.

### "FOOD FOR R.S.G.B." APPEAL

The acting Secretary of the R.S.G.B. has notified the Appeal Committee that the first 16 parcels have arrived in England, and by now will be distributed by ballot to members. Another 26 parcels have been sent, making a total of 76 parcels despatched to date. Each of these parcels

contain about 8 lbs. of foodstuffs making over a ¼ ton of food sent.

At the general meeting held on the 2nd July, donations by the box collection totalled £10/15/6. The raffle of a new 813 and socket was won by VK3KM and yielded a sum of £12/4/—a very excellent effort for the night. During the meeting two very generous offers of radio gear were made for the raffles. The Committee wish to express their gratitude to both VK3TO and the other donor (whose name is not known at present) for these very generous gestures.

The following raffles will be held at future general meetings:—

- (1) A new 5BP1 (5" c.r.o.) and socket—August 5.
- (2) A new 813 and socket—September 3.
- (3) A Disposals Transmitter—October 1.
- (4) 9002, 9003, 6J6, two 1N34s and 455 Kc. crystal—November 5.

Tickets for each of these raffles are 1/- each and Country Amateurs interested should send postal notes, made payable in Melbourne, to VK3UM, the Appeal Secretary, indicating the raffle for which the tickets are required.

The following country organisers have been appointed to conduct the Appeal in their Zones:—

- VK3YV, North Eastern Zone.
- VK3QC, South Western Zone.
- VK3QZ, Eastern Zone.

## What You have been waiting for

AVAILABLE FROM STOCK

## TAYLOR TRANSMITTING TUBES

Very Low Driving Power Required.

T20 TRIODE, 42 watts output, Class C	£2 2 6
T40 TRIODE, 150 watts output, Class C	£2 18 6
T55 TRIODE, 168 watts output, Class C	£4 0 0
T810 TRIODES 475 watts output, Class C	£4 0 0
TB35 TETRODE, 130 watts output, Class C, to 250 M.C. half power to 400 M.C.	£6 10 0
TZ20 ZERO BIAS MODULATOR	£2 2 6
866 JUNIOR RECTIFIERS	£1 4 0
866 RECTIFIERS	£1 5 0

Full data forwarded on request.

Crystals as illustrated. 40 or 80 metre AT or BT cut.

Accuracy 02% of your specified frequency, £2/12/6.

20 Metre Zero Drift £5/0/0

Large unmounted 80 or 40 metre, zero drift, £2.

Crystals Reground, £1 each.

Filament Power and Modulation Transformers made to order. Reasonable Prices Prompt Deliveries.

T.C.C. 1.5 MFD. 5000 volt Working Condensers . . . . . £2 5 0



## BRIGHT STAR RADIO VK3UH Late R.A.N.

1839 LOWER MALVERN ROAD, GLEN IRIS, S.E.6, Victoria. Phone: UL 5510

Organisers are still required in the Central Western and North Western Zones, and any amateur who can undertake the organising is asked to communicate with VK3UM without delay. This is a very worthy cause and the Committee desire all Amateurs in Victoria to be represented in the contributions to our English brother Amateurs, so send in your donations. All cheques or money orders should be made payable to the "W.I.A. Food for Britain Patriotic Fund."

The total donations to the Fund are now £110/15/4, the total expenditure on parcels £70/13/- and cash in hand and bank £40/2/4. Tune into VK3WI every Sunday morning at 1130 hours on 7 Mc. for further news of the Appeal.

#### TECHNICAL ADVISORY COMMITTEE

The Committee is preparing plans and estimates for proposed alterations at the Institute Rooms for a laboratory test bench. The implementation of this plan will make full test facilities available for receivers, instruments, transmitters and meters.

It is again requested that any Amateurs who have a Ham-built Amateur-band receiver of their own design, are asked to send details of it through the Magazine Editor. The T.A.C. will prepare the article, if necessary, for publication. Meeting night is third Tuesday in each month.

#### V.H.F. Group

At the last meeting of this group, the results of the recent Field Day for 166 and 50 Mc. gear was discussed. It was decided to hold the next Field Day on 7th September, and the co-operation of other States and New Zealand have been sought. It was also decided to hold Field Days every two months to promote a greater interest in the "very highs."

The next three meetings of this group, will be devoted to discussions of equipment used on 166 and 50 Mc. and the results of these discussions will be published in "A.R." The discussions will be on Aerials, Transmitters and Receivers. For a detailed diary of V.H.F. doings, see notes elsewhere in this issue. Meeting night is first Wednesday in month.

#### Receiver Group

The last meeting of this group was a great success, and a greater interest is now being shown in the group's activities. All interested are cordially invited to be present. The meeting held on 23rd July consisted of a demonstration of modulation envelopes, using the c.r.o. in conjunction with the i.f. stages of a receiver. Meeting night is fourth Wednesday in month.

#### Libraries

At present, very little interest is being taken in the very fine reference technical book or instrument libraries by members. The range of both books and instruments available are contained in past issues of "A.R." Use this service—it is yours. Books and instruments are available on any meeting night providing the Secretary of the T.A.C., VK3UM, is notified the day before the general meeting.

#### General Meetings

Unfortunately, the lecturer for the last general meeting, Mr. Wall, Chief Navigation Instructor for A.N.A., was unable to be present owing to absence from the State, but instead, three very interesting and instructive

films were shown; two on the electro-chemical action of batteries and the other of general interest on farm mechanisation in Britain. As the next general meeting on the 6th August is the Annual General Meeting, the time will be spent in W.I.A. business and election of office-bearers.

#### S.W. ZONE NOTES

The first S.W. Zone hook-up took place on Sunday, 6th July, and proved to be very popular; so much so that it took quite a long time to get over the first round.

3AMP assures the gang that the next will be a more snappy affair and ideas gleaned from the experience of the first hook-up will be put into operation. A time limit will be put upon transmissions and it is possible that the time of commencement may have to be altered to dodge QRM. We want your ideas on that matter and also whether you favour 7 or 3.5 Mc., so let us know fellows.

Some personal paragraphs have been received from 3HG for which the writer (VK3BI) offers thanks and wishes some others had sent in some news too.

Bill Ross, of Grassmere, has offered to donate some gear, for Zone trophies in contests or other activities, for which we thank him very much.

3AMP has new transmitter in operation for 7 and 3.5 Mc. Sounds OK too Murray. — — — 3MC has big new rhombic which is working very well indeed and is rebuilding rig to rack and panel. — — — 3NC working nightly skeds with VE2AX still with only six watts, and has new two tube super working well. — — — 3HG recently lost two antenna poles in one night as a result of sabotage by one Hereford bull!! Also did in two genemotors. — — — 3MH is receiving a huge stack of QSLs so must be working DX well. — — — 3BI has new v.f.o. working experimentally and is pleasantly surprised at stability.

By the time you read this the Zone DX contests will be over and I hope you have sent in your entries. I would also be pleased to receive your 5/-

## QUEENSLAND

Secretary: R. Thorley, VK4RT, Box 638J, G.P.O., Brisbane.

Meeting Place: State Service Building, Elizabeth Street, City.

Meeting Night: Last Friday in each

A large number of members rolled up to the general meeting of the Queensland Division held on Friday, 27th June. The number present constituted a third of the present membership, which is a round-about way of announcing that we now have 115 members, the highest ever, we believe. Mr. Frank Nolan (4FN) spoke on a suggestion by 4LN of Gympie that something might be started along the lines of a Food for Britain cam-

# Low Drift Crystals

FOR

## AMATEUR BANDS

ACCURACY .002% of  
STATED FREQUENCY

3.5 M/C and 7 M/C

Unmounted . . . £2 0 0

Mounted . . . £2 10 0

12.5 and 14 M/C Fundamental Crystals, "Low Drift" Mounted only £5.

Spot Frequency Crystals  
Prices on Application

Regrinds . . . £1 0 0

THESE PRICES DO NOT  
INCLUDE SALES TAX.

# Maxwell Howden

VK3BQ

15 CLAREMONT CRES.,  
CANTERBURY, E.7.

paign. Mr. Argeat (4KH) also spoke at length on the subject and outlined his own experiences in handling Food Parcels and so on. At all events a fair degree of success resulted from the President's appeal for contributions, and £8/15/- was collected and the sum of £5/10/- was promised each month in addition to stray donations. Any members wishing to assist should contact the Secretary who will pass the matter on to the Committee formed to handle the project, the members being 4FN, 4KH and 4RC.

The President (4AW) regaled members with an account of the recent D.F. Field Day. The hidden transmitter was operated by 4ES, and Herb hid it to such good effect that nobody found the thing at all during the morning. It seems that 4RY's party, comprising 4FB, 4JP and himself, might have found it in the morning but a "gremlin" had tampered with the coils of the receiver and the calibration was astray. The local 50 Mc. lights, 4RT and 4KB, won the event in the afternoon, and the runners-up also happened to be V.H.F. men, being none other than 4RY and company anxious to make amends for the morning. The event we might add was held on 7 Mc. It seemed that a good time was had by all, the writer regretting that he was not able to attend.

To return once more to the general meeting which we left a few moments ago, a most interesting lecture was presented by Mr. Vince Jeffs (4VJ) who chose for his subject "Frequency Modulation." Vince had evidently gone to considerable pains in the preparation of his talk and those present were treated to a most comprehensive account of F.M., its advantages, disadvantages and of the gear used for transmission and reception. At the conclusion of the lecture Vince demonstrated the action of a limiter when used with a conventional superhet.

4WI listeners are being well catered for these days as regards lectures. On Sunday, 6th July, 4KB presented the first of a series of talks of V.H.F. character, the title of the first being "An Introduction to Micro Wave Technique." Pat dealt mainly with the Cavity Resonator and Transmission Lines or Wave Guides. Charts with appropriately numbered diagrams had been distributed to those members in the country requesting them, and the clarity of the lecture was thus materially assisted. It seems that 4WI has quite a large audience as many reports are received from non-members and other listeners. The transmissions on 14 Mc. are worth keeping in mind if you are having trouble on 7 Mc. in receiving 4WI. Reception in various parts of the city area is considerably better on the higher frequency and between one or the other we are sure you will enjoy good reception, not perhaps as

excellent as that spoken of by 4VJ when dealing with F.M., but good not-with-standing.

It is hoped shortly to issue to country members a monthly bulletin or leaflet giving the latest Divisional dope. Contents will probably include details of forthcoming Field Days, etc., the results of ones just held, ionospheric tips, outstanding DX that happens to be about, Council report or a summary of same, and in general any news that we think will be of interest. The scheme has barely seen the light of day at this writing, but it has so much to recommend it that we feel justified in mentioning it here. It will be realised that in lots of cases it is impossible to publish in "A.R." any such material, for the simple and obvious reason that the news is very much out of date when published, or to take the other extreme, plans for Field Days, etc., are never finalised so far in advance as to permit of their insertion in "A.R." in time to be of use.

Although the matter is primarily a V.H.F. one, and is dealt with in that Department, some 24 Ground Plane Antennas were disposed of at the June general meeting, every one being of the opinion that they were an extremely good buy (7/-) for those V.H.F. bent. The frequency these antennas were designed for was 74 Mc. but conversion to 50 Mc. is very simple.

## SOUTH AUSTRALIA

Secretary: E. A. Barbier, VK5MD,

Box 1234 K, G.P.O., Adelaide.

Meeting Place: 17 Waymouth Street, Adelaide.

Meeting Night: Second Tuesday of each month.

The monthly general meeting of the W.I.A. was held on Tuesday, 8th July, and an all-time record attendance was reported. Some estimates gave it as 300 members, some as 200, but I will be conservative, and give it as 230. The attendance was in theatrical terms a "sell out," in fact at the commencement of the meeting there were a large number of people still out in the street trying to get in. Using a great deal of persuasion they were eventually squeezed in and all were happy.

Among the visitors, many of whom could not get near the visitors' book to sign, were Keith Bun (VS1AV) and Johnny East (ex 2nd op. at ON4RM) who were both from the visiting aircraft carrier "Glory," Arthur Evans (VK3BQ), Inspector I. Delderfield, Chief Police Technician Mr. Gosse, and many members of the police force who are interested in F.M. To the many visitors who have unfortunately been missed, we apologise and can only blame the huge crowd.

The lecturer was Mr. Frank O'Grady of the P.M.G.'s Department, who spoke on Frequency Modulation.

# G L O - R A D

## SOLVES YET ANOTHER PROBLEM!

The experimentally minded Amateur has always been faced with the problem of getting special parts, etc., made at reasonable cost. Recent progress in V.H.F. and Micro-wave Techniques has further complicated this problem.

"GLORAD" is now in a position to cater for YOUR requirements, large or small.

Send sketches and full details to:—

**GLORAD ENGINEERING SERVICES**  
186A Riversdale Road (Cr. Robinson Road)  
**HAWTHORN ————— VICTORIA**

Phones: Day—WA 3819. Night—WX 3440

Mr. O'Grady could have been pardoned for blinding with science the entire gathering, as the subject F.M. lent itself to an array of formulae and mathematics far beyond the comprehension of all members present. However, as has often been said, the secret of greatness is the ability to bend to the common touch, and Frank (if I may be pardoned) bent to the subject and applied it to amateur radio. He prefaced his lecture by saying that he had not expected such a large audience, but it was evident that everybody was becoming F.M. conscious. He then said that many people imagined that F.M. was something new, but many old timers in Ham Radio were using it when they were on "loop" phone many years ago, accidental but true.

During spark days the Poulsen Arc people tried F.M. but experienced considerable difficulty in applying it to the arc system. The original idea behind F.M. was an endeavour to save space in the radio spectrum and to eliminate QRM. Unfortunately mathematicians were able to show that whether F.M. or A.M. was used the crowding of the spectrum and the QRM was about equal. Dr. Armstrong in 1929, endeavouring to reduce static and noise in radio reception, combined a number of separate conclusions and tests to achieve results and thus came across all the ingredients for successful F.M. When we consider that in a short space of three years there has sprung up in America 300 F.M. stations and 500 under construction, with a host of applicants ready and willing to take out licences for F.M. as against some 900 odd A.M. stations over a period of the past 20 years, we begin to realise that F.M. is definitely on the way to oust A.M. as applied to broadcasting. Frank said at this point that he could not hope to cover all phases of F.M. as applied to broadcasting in one or many nights, but would confine his remarks to the amateur viewpoint only.

For high quality broadcasting, F.M. demanded the wide deviation system whereas in amateur work where high quality was of secondary importance a narrow band system of F.M. was quite satisfactory. He emphasised the point that a definite distance from a station the signal to noise ratio drops suddenly with wide band F.M. but narrow band F.M. holds up past this point and is therefore more applicable to amateur radio. In A.M. two stations working on a shared channel principle required only a one per cent variation in strength or frequency to cause trouble to listeners situated midway or so between the two stations. With F.M. the interfering station would have to be at least 50% stronger to cause interference due to what is known as "capture" effect. This has advantages for amateur work which cannot be denied, as although the

present high frequencies may be wide open spaces, the same could be said of the 28 and 14 Mc. bands several years ago.

Early F.M. was used experimentally on 40 Mc. because it was considered that no reflection trouble was likely to be encountered. When police cars in Los Angeles began answering radio calls from New York it was necessary to revise this fallacy and attempt a move to 100 Mc. or higher. This mooted move was greeted with open hostility by Dr. Armstrong and the "battle" is still in progress, somewhat halting the march forward of F.M. At this point Frank resorted to the blackboard to explain several points which naturally stops the trend of this re-write. However the above has, I hope, helped the country member to realise that the lecture was a huge success and the vote of thanks (which followed question time) proposed by 5BY was received with prolonged and enthusiastic applause. The meeting adjourned at 10.45 p.m. but it was well after 11 p.m. that the lights were turned out in an endeavour to shift the blighters. "Doc" personally pushed the last one into the street and when I left they were still going strong.

The A.O.C.P. classes opened to a full house this month. Never before have the applications come so thick and fast, resulting in the classes being 100% overfilled. Most pleased man of all was "Doc" Barbier (5MD) who fought the Council almost lone handed when a move was suggested to the School of Mines, thus possibly losing an obvious recruiting ground for the Institute. He is wearing that look of the cat who swallowed the canary these days and almost exudes "I told you so."

The official W.I.A. station (VK5WI) operating on 7 Mc. each Sunday at 10 a.m. and 3.5 Mc. each Sunday at 7.30 p.m., is doing a real good job and full credit must go to R. G. Harris (VK5RR) and second op., Joe McAllister, for an extra good job.

Two new junior ops reported this month. Geoffrey Ross Harris aged 5½ weeks whose Pop is 5FL, and Roslyn Jean McLean aged 3½ weeks and the proud Pop is 5ME. Both fathers are doing as well as can be expected!

Brian Palk (5FQ) must be putting in a good signal into W on 14 Mc. W4TM called CQ the other evening at 1800 and I personally counted 27 stations from all States in VK calling him, but he went back to Brian, saying that 5FQ was the best of all the stations calling him.

Regarding my paragraph last month re 5RT and the super regens, Bob tells me that he did not say anything against super regens as he uses one himself. What about it now Mr. Anonymous.

5BG and his offside 5AM (from Murray Bridge) were in attendance at the meeting. Shows the enthusiasm, coming all the way from Murray Bridge.

We secured some nice publicity in "Radio Call" this month when 5GF and 5LW figured in a record making contact on 166 Mc. Mount Lofty Summit to the Hummocks was the distance, approximately 72 miles.

Two matters of interest considered by Council this month were that of increased seating capacity for the general meetings, and the purchase of some form of recording apparatus, preferably a ribbon recorder, with a view to recording lectures, matters of interest, etc., for re-broadcasting to country members over the official W.I.A. station (VK5WI) on Sundays.

## Australia's Largest Stock of All Radio Components

Chokes  
Coils  
Condensers  
Dials  
Intermediate Transformers  
Mose Equipment  
Potentiometers  
etc., etc.  
Resistors  
Soldering Irons  
Speakers  
Test Equipment  
Valves  
Pick-Ups  
Power Transformers  
etc., etc.

Obtainable from

## Bloch & Gerber Ltd.

with which is associated  
the

### WELDON ELECTRIC SUPPLY CO.

46-48 YORK STREET,  
SYDNEY

G.P.O. Box 2282 M

Phones: MA 6291 (10 lines)

## WESTERN AUSTRALIA

Hon. Secretary: W. E. Coxon,  
VK6AG, Howard St., Perth, W.A.  
Meeting Place: Builders' Exchange,  
St. George's Terrace, Perth.  
Meeting Night: Second Monday in  
each month.

As the July meeting fell later in  
the month, notes from this meeting  
were too late for this issue, but will  
appear in the September copy.

A very successful 7 Mc. "QSO Day"  
was held on the 29th June. The com-  
petition opened at 10 a.m. and from  
then on until 5 p.m. the 7 Mc. band

was like 14 Mc., a real QRM band.  
Approximately forty-five VK6 sta-  
tions appeared and as some were  
only operating for a short period the  
competition was keen.

The day was a preliminary try out  
for a 7 Mc. field day to be held in  
September when portable stations  
will be able to gain extra points. The  
weather will be right for a good out-  
ing so everyone that can possibly get  
some portable gear together is asked  
to make the day a success.

### PERSONALITIES

6MU was heard on 7 Mc. during  
"QSO Day" with his FS6 transceiver  
mobile. A good job Malcolm. — — —  
6MW is doing some fine DX with  
that long wire antenna, even during  
the present poor conditions. — — —  
6GM made his official debut on the  
29th with a f.b. sig on 7 Mc. George  
was using a small portable ex-Army  
type transceiver. — — — 6AG also  
heard making a hole in the ether on  
the "QSO Day." It is pleasing to hear  
so many of the old calls coming back  
on the air again. — — — 6RU is  
temporarily in retirement. Bad luck  
that the 80 m.p.h. gale blew the  
rotary beam down Jim, however, is  
building bigger and better beams so  
will soon be back again. — — — 6FL  
another sufferer from the gales.  
Frank, however, can be heard using  
another antenna and still working  
them. — — — 6KW still heard  
regularly, but with conditions so  
poor Ron doesn't spend the time on  
the air that he used to. — — — 6DF  
had a bad sinking feeling within the  
abdomen when he came home to see  
his 50 ft. tower lifting inches out  
of the ground. Maurie was seen  
frantically guying and shovelling for  
many hours. The result is "the tower  
still stands."

6SA not heard so regularly these  
days. The Government must be  
working poor old Jim too hard.  
— — — 6BC appears on the 14 Mc.  
band occasionally but finds time to  
use the new rig in between his num-  
erous other interests. — — — 6LW  
not heard on very much lately. May-  
be Wally is building an f.m. rig now  
this type of emission is permitted?  
— — — 6WH is a stalwart on 7 Mc.  
What about 14 and 28 Mc. Ted? They  
are still there you know. — — —  
6WT has some f.b. phone now and is  
looking for his VK3 friends to have  
a real chin wag. — — — 6TW just  
returned from a "flying" trip to the  
East. Bill shifting QTH and hasn't  
been heard much lately. — — —  
6HM a quiet man lately. We wonder  
what Charlie is cooking up? — — —  
6DD temporarily "off the air," also  
shifting QTH. We believe from one  
room to another; if he can find one!  
— — — 6GB was tempted from the  
higher frequencies around 50 Mc. in-  
to the 7 Mc. band on the 29th.  
— — — 6WS another "cat walk"  
builder. Skipper finds lowering tow-  
ers to the ground every time an ad-  
justment is to be made is "not so  
easy."

## TASMANIA

Secretary: J. Brown, VK7BJ  
12 Thirza Street, New Town.  
Phone W 1328.

Meeting Place: Photographic Soci-  
ety's Rooms, 163 Liverpool Street,  
Hobart.

Meeting Night: First Wednesday of  
each month.

This month's meeting was notable  
for a lecture given by Charlie Old-  
ham (7XA) based on ionospheric re-  
search, an interesting follow-on after  
the visit made by members to the  
station at Cambridge.

Not less welcome was his an-  
nouncement that a total of £35 has  
been reached by the Division's Food  
for Britain Fund, only recently es-  
tablished. Acting on a letter received  
from the R.S.G.B., it has been de-  
cided to concentrate mainly on the  
shipment of fat, to which end satis-  
factory arrangements have been  
made with local tradespeople. Char-  
lie's work in adding our drop to a  
worthy bucket is much appreciated.

With an eye to the changes through  
which the old hobby may yet have  
to pass, and the fact that the public  
still as no reason to believe that a  
Radio Amateur is anything but a  
struggling soprano sponsored by  
Somebody's Soap, it is hoped that a  
member of Federal Parliament may  
shortly be conducted around some  
representative shacks. Just to sort  
of brighten up, the boys might well  
get in some practice on commercial  
programme accents in order to pro-  
vide him with some "trans-Pacific"  
contacts—DX may be poor that day!

It's inconsiderate and all that,  
helping to swell the QRM, but the  
Hobart Technical College has for  
some time now been running A.O.  
C.P. classes, with Terry Connor  
(7CT) at the blackboard. Four new  
Hams have resulted so far and more  
are in the offering. And they are all  
in the W.I.A.

The bi-monthly 7WI broadcast and  
intra-state ragchew on 7 Mc. have  
been making heavy weather of it  
lately, due to long skip on that band  
at night. 3.5 Mc. phone raises the  
BCL bogey for many of us, so Sun-  
day mornings on 7 Mc. are becoming  
more popular as an alternative. These  
ragchews, as mentioned before, fill  
a need which is peculiar to VK7.  
Most know each other personally,  
but seldom click on a random QSO  
owing to the variable conditions en-  
countered; and numbers are still  
small enough to keep a state-wide  
QSO from becoming too cumbersome.  
Or are they?

7AB, 7XL and families, together  
with 7BQ and occasionally 7DS are  
putting fine signals at present into  
Hobart from the north-west and  
north. 50 Mc. is receiving plenty of  
attention from 7XL and 7AB, and,  
judging from other building going  
on, we may even see some north-  
south contacts on this band before  
long.

Eighty's oldest inhabitant, 7AG, is

AMATEUR RADIO; AUGUST, 1947

## COMMUNICATION RECEIVERS

AMR—200

15 TUBES

Frequency Range

1250 K.C. to 30 M.C.

in 5 bands.

Crystal Filter

Variable Selectivity I.F.'s

3-16 K.C. Band Width

## NOISE LIMITER

110-240 Volt A.C.

or

12 Volt D.C.



## D & S

## Radio Service

1014 HIGH STREET,

MALVERN, S.E.3

Phone: U 9537

still raising the echoes around Gretna and doing all right with ZLs on phone. One can hear an occasional European on 3.5 Mc. in the mornings, but from all accounts the Kiwis have it all sewn up—W.A.C. between them during the past year.

Our wild weather, with attendant floods, brought memories to Hams in two places recently. To 7CW who, with a Launceston station, established an emergency traffic link handling thousands of words for the Post Office when, during a similar period in 1929, all line communications with the northern city were severed for some days. And to the northern gang, memories of home and mother while stuck in the mud somewhere out along the road on their way home from last month's annual dinner.

#### NORTHERN ZONE

As these are the first northern district notes to be written post-war I will first of all explain the set up now functioning in the north of the Island. Most of the stations in Tasmania are, broadly speaking, grouped into three localities, namely southern, northern and the north west coast. It is now considered advisable to in future publish the activities of the northern members separately so as to more fully cover the activity of these members.

Active amateurs in this area at present are 7BQ, 7RK, 7DS, 7GD and 7LZ, whilst Mr. P. Crawford ably fills the position of second op. at 7BQ. In the north west sector 7AB, 7XL and 7LT appear to be the most active. Although meetings are not being

held as yet in this area all members are friendly and co-operate to a degree that promises well for the future of amateur radio and with several prospective Hams in our midst the future looks better than ever before.

A party consisting of 7BQ, 7GD, 7RK, 7LZ and Mr. P. Crawford travelled to Hobart for the annual meeting of the Institute. We were entertained in a manner far beyond anything we thought possible, an itinerary having been arranged that showed us everything in wireless, both amateur and professional that was to be seen—even if it wasn't supposed to be seen.

7BQ and 7LZ were extremely interested in the 50Mc. gear at 7CW and 7NC's. It looked so easy down there too. We know better now; believe 7AB has similar views on this subject.

7BQ is busy getting a 50 Mc. rig on the air. Also does a lot of listening and is often heard on 7 Mc. The 28 Mc. band is also occasionally used with the help of a three element rotary. — — — 7DS is having trouble with an 807 in his 14 Mc. rig. Complains that DX isn't what it used to be. — — — 7GD on 7 Mc. with a converted Army job on low power. — — — 7RK uses c.w. on 14 Mc. and has worked quite a bit of good DX lately. If you don't believe me ask his wife. — — — 7LZ at present building a 50 Mc. rig, also active on 14 and 28 Mc. using both phone and c.w. — — — Have not heard from 7AB and 7XL lately, however understand that both are putting in a lot

of time with 50 Mc. gear. Tasmania should be extremely well represented on this band in the near future.

DX during June and early July has been very patchy and the few good stations heard were being eagerly sought after by the multitudes from W land.

Constant listening on 14 Mc. lately has given the impression that the latest American idea, as used by the less responsible members of the fraternity, is to use a T7 note—with or without chirps. Coming on top of the bad use of the v.f.o., this just about puts the lid on things.

With respect to the donation of £2/2/- which the South Australian Division made available to the Broken Hill Boys' Club, to assist them in their radio work, a splendid letter of appreciation was received from the Superintendent, Rev. Guthberlet. What about it you other Divisions, two guineas will not send you broke!

#### W.I.A. 1914 International DX Contest

(Continued from page 8)

ing CQ or TEST. Verification of reception must be made in accordance with the conditions in Rule 3 above.

6. VK receiving stations cannot log any VK stations—only overseas stations. Overseas stations will enter up VK stations heard only.

7. The awards for the receiving contest will be similar for the winners in the transmitting tests.

8. Receiving logs are to be similar to transmitting logs.

## RED LINE TRANSFORMERS & CHOKES

For the **F.F.R.** Amplifier

Type No. AR2

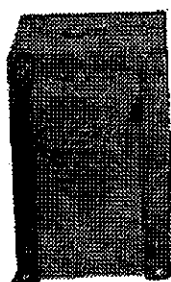

Type No. No. 5176



Type No. 50825



Type No. 102512

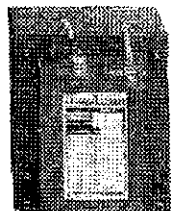

Type No. A.W.5

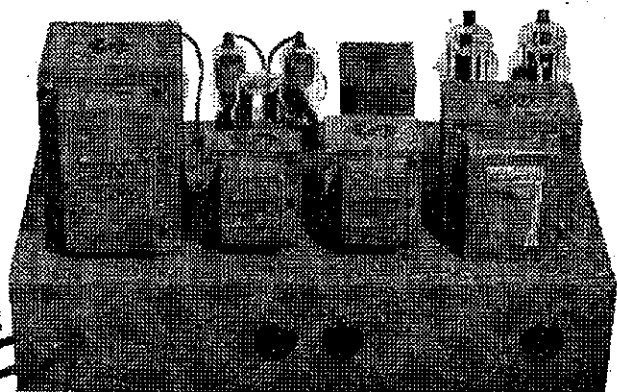

Pamphlet describing design and construction of the Full Frequency Range Amplifier available from:

## SWALES & SWANN

Technical Service, A. T. SWALES, Cent. 4773  
Wholesale and Manufacturers: 2 Coates Lane, Melbourne.

Trade Sales: ALLEN SWANN  
MU 6895 (3 Lines)  
157 Elizabeth St., Melb.



# QUIET

PERMANENTLY

Silent Spiral  
Connector...



NO SLIDE  
NO FRICTION  
NO NOISE

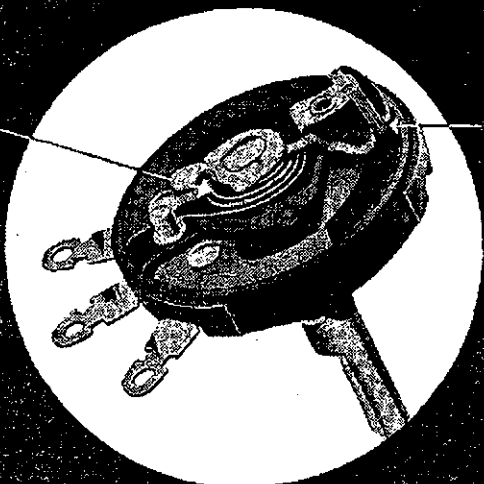

5-Finger  
"Knee Action"  
Contact



AMAZINGLY  
SMOOTH...  
PERMANENTLY  
QUIET

## FIFTY AND UP

OPEN AGAIN

The 50 Mc. band opened again on Sunday, 6th July. VK4SN, 4HA, 4RT and 4KK were heard in VK3, while VK3HT, 3ZL, 3BD, 3DM, 3X?, 3BN and a station 10 miles from Geelong, were heard in VK4. VK4SN, of Tambourine, worked VK3HT, near Melbourne, while VK4KK, at Millmerran, worked 3ZL at Ballarat. There is good reason to believe the band was also open for longer DX—eastwards.

On 24th June, J9ACS worked 400 miles to J2AAO in Tokyo on 50 Mc. for a 4 hour contact and on the same night 50 Mc. opened in ZL from 1800 to 2000, ZL2 working ZL3s.

VK3ZL, in Ballarat, worked 3HK, at Mitcham, on 19th July at 2115-2215. Signals were R4 S3 at start, rising to R5 S5. This is the first time a Ballarat station in the Ballarat "bowl" has ever worked a Melbourne station on 50 Mc. The distance was 77 miles, and definitely not line of sight.

### NEW SOUTH WALES

Interest in the V.H.F. section continues to grow. At the meeting held on Friday, 11th July, an extremely interesting lecture was given by Mr. T. W. Kinsella (2FK) who took as his subject "The Conversion of Disposals A.S.V. Equipment for 166 Mc. Operation." The enthusiasm of these chaps is amazing, Mr. Bill Hill (2XT) for instance, came from Kurri Kurri, well over one hundred miles, to attend the meeting.

### VICTORIA

V.H.F. Group meeting was held as usual on 2nd Wednesday in month. Good attendance of both 50 Mc. and 166 Mc. Hams as well as visitors. It was decided that field days in future be held every two months on the Sunday following the main general W.I.A. meeting. The next Field Day is to be held on 7th September, and at the next V.H.F. meeting proposed locations, etc., will be discussed. Publicity through W.I.A. channels to all VK States, ZLs, and Ws.

That at next V.H.F. meeting main topic to be "V.H.F. Antennas" including a lecture on Ground Plane Antennas." Colin, 3ACM, to be Chairman.

166 Mc.—General interest and discussion about gear. Main problem was grid drive, and lack of suitable tubes for 166 Mc. final. 3LS displayed his 166 Mc. Ground Plane Aerial and explained the construction and operation.

VK3ANW was present and made a very handsome offer of V.H.F. tubes for the best local DX worked while he is over in England. Ken, who was wished "bon voyage" and a safe return by all, said "Au Revoir" and shook hands all round. He will be away for 18 months.

# IRC VOLUME CONTROLS

IRC HAS SPARED NO EXPENSE SO THAT  
YOU CAN BE SURE

Study the design of IRC Metallized Controls. Note in particular the precision construction of the 5-finger "Knee Action" Silent Element Contact and the new Silent Spiral Connector.

Each of these exclusive features means thousands of pounds in research by IRC engineers. Each means additional manufacturing expense—yet IRC Controls cost you no more than ordinary controls having neither of these noise-eliminating features.

It is "plus" values such as these that have made IRC resistance products famous the world over. By giving you the greatest value for your money, by doubly insuring you against customer complaints, we protect our reputation by helping you protect yours. That is good business for both of us.

Sole Agents for Australia:

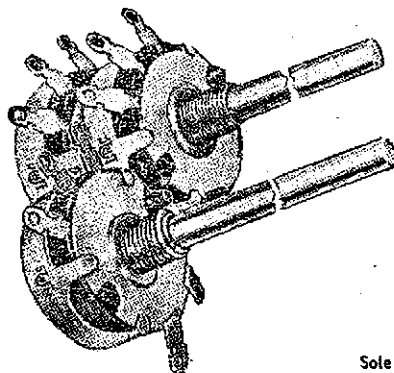

## Wm. J. McLELLAN & CO.

BRADBURY HOUSE, 55 YORK ST., SYDNEY • PHONE BX2508

**Field Day Notes.**—Weather was poor, the boys up on high places did a freeze in the fog, rain, snow, etc. The only station to do the writer the courtesy of sending in a report was 3LS who was with 3MN and 3AKI at Arthur's Seat and only worked on 166 Mc. The best contact of day was 3LS and 3YS, 73 miles airline. The gear at 3LS was tx: two CV6 tubes linear line p.p. 7 watts and 6V6 mod.; rx: 958 and 1Q5 audio, while the antenna was a ground plane 12 feet high.

3XA went to Macrae, near Dromana. The 50 Mc. gear consisted of 6AK5, 6AK5, 6C4 into AMR200. Tx EF50 c.o., EF50, 832, 20 watts input. The 166 Mc. gear was a 6 stage Tx: 6V6 c.o., 6U6, 7C5, CV6, 832 with 25 watts input. Rx: 6C4 super regen.-audio worked on 166 Mc. Everything went wrong even soldering iron blew out.

3YS and 3ABA at Macedon worked on 50 and 166 Mc. Tx: 6V6 c.o., 6V6, 6V6, 832 final for 50 Mc. with 3 watts input. The 832 was used as tripler with  $\frac{1}{4}$  watt out on 166 Mc. Rx for 50 Mc. was 1852 converter, while for 166 Mc. a 9002 and two audio did the job.

3MJ and 3ANW went to Mt. Donna Buang. 3MJ on 50 Mc. used a modified Type 3, 6V6 c.o. and 807, 20 watts and cathode mod. Rx was 6AK5 mixer and 6C4 into Type 3, antenna was a doublet. 3ANW on 166 Mc. used a CV6, m.o. into 832 p.a. with 8 watts input, mod.: 6C6, 6C6, 6A6 class B and xtal mike. The antenna was a vertical co-ax dipole 16 feet high. Rx: 9 tube super. Best DX was 3YS at Mt. Macedon, 64 miles. Signals were S9 to S7.

3HK and 3YJ at Mt. Dandenong used 3HK's c.c. portable on 50 Mc. and a super regen on 166 Mc. The 50 Mc. rig was 6V6 c.o., 6V6 into 807, 7 watts, and 79 mod. Rx: 6AK5, 6AK5, 6C4 into FS6 Rx.

3IV, 3YT and 3SE were at Mt. Buninyong near Ballarat. No details to hand except that 3SE worked 3HK.

Best 50 Mc. contact was 3HK at Dandenong to Ballarat City, 3ZL. First time this has ever been done. Best 166 Mc. was 3LS at Arthur's Seat to 3YS at Macedon, 73 miles.

#### QUEENSLAND FIELD DAY

VK4SN took his DR106 set up to the mountains near Tambourine (50 miles from Brisbane) on 6th July where he worked all locals and 3HT and 3ZL. This was his first appearance on 50 Mc.

On 22nd June, all the locals were out hunting down 4ES's hidden transmitter.

#### SOUTH AUSTRALIAN RECORD

On 166 Mc. VK5NG on Mt. Lofty worked VK5GF at the Hummocks 70 miles away, line of sight. This contact took place on 25th June. Rigs used were mod. osc. and super regens. 5NG used 32" matched impeded dipole, tapped 3" off centre and 4

watts input. 5GF used  $\frac{1}{2}$  wave doubler. 5NG wore three overcoats and still shivered.

#### WESTERN AUSTRALIA

VK6SA and 6LW provide the portable activities on 50 Mc. 6SA takes his portable on the boat during weekend fishing trips to Rottnest and Rockingham, while 6LW visits higher points within car distance of Perth. Best distance was 73 miles portable to fixed location. 6SA expects to go to Rottnest West and 6LW to Northam for new DX.

#### PERSONALITIES AROUND THE STATES

No notes from N.S.W. Poor show, all busy working DX?

3NW, referring to the field day, says that on 166 Mc. the first hour produced a solid mass of stations which showed clearly the need for stabilised transmitters and more selective receivers. In fact QRM was a trouble all the afternoon although we had four megacycles to use. The extremely low power used by many of the stations gave surprisingly good signals.

DR106s are popular. VK4CT, 4HA, 4RT, 4KK, 4SN, 4ES and 4XG all use them. Fitting xtals to transmitter helps stability. Disposal ground plane antennas are used by 4KB, 4ZU, 4FB, 4RT and 4HB. "QST" for May gives good dope on ground planes.

5GB and 5JD have proved that crosstown QSOs on low power are 100% OK on 166 Mc. and suggest that V.H.F. should be used to reduce congestion on lower frequencies. 5GB is trying out parabolic 166 Mc. reflector.

Those trying out receivers etc. on 50 Mc. in VK6 should listen between 8 and 8.15 p.m. If you don't hear anything its time to check receiver. Country boys—call us on 7 Mc. on Sunday—pleased to help you.

No notes to hand from VK7. Believe 7XL is still busy drying out his wax. 7AB has new xtal. 7BQ uses 6L6 trip. to 807 doubler to 807 buffer to 807 final.

#### A VARIABLE FREQUENCY OSCILLATOR

(Continued from Page 6)

stability of the note. The sockets used were of a type which had a large area of the contacts near the shield cover, and were therefore forming a capacity to ground, particularly at the oscillator grid pin. Changing the type of sockets cured this trouble, so take particular care that the oscillator and isolator have the best quality Ceramic sockets.

For those Amateurs who prefer to operate the oscillator on 160 metres, the coil data is as follows:—

27 $\frac{1}{2}$  turns of 30 s.w.g. on a  $\frac{3}{8}$ " diameter former, threaded 24 turns per inch. The cathode tap is determined experimentally, but will be about 8 turns from the cold end, and

the crystal resonator tap will be 1 turn from the ground end. The fixed capacity is made up of 700 pfd. of Simplex mica, and 100 pfd. N750 Ducon Ceramicon. The value of the Ceramicon was found to give correct temperature compensation in this oscillator.

Do not try and wind the coils without the former being threaded, because it will be impossible to make a satisfactory coil. If you do not possess a lathe, or know of a friend who has one, the local garage man will oblige for a few pence.

## SPECIALS! WHILE THEY LAST

O—.5 Amp. Thermo  
Ammeters, 17/6

### METER SCALES

Suitable for Pullin "Disposal" meters. Volt-M.A.-Ohm or special Multi-meter scale.

Either type, 2/-, post free.

### POWER TRANSFORMERS

Wound on extra large core. Any voltage or amperage—Reasonably priced.

7-DAY DELIVERY SERVICE

Multi-Match modulation Transformers. 75-watt. In die-cast metal clamps.

Write for full details.  
£4/19/6. DELIVERY EX STOCK.

### CHASSIS — RACKS — PANELS

Any size, any gauge. Write enclosing full particulars. Quotation forwarded by return mail.

VK3NU

## Major Radio & Electrical Co.

189 GLENFERRIE ROAD,  
MALVERN

WM 1814

U 9354

# Telegraph Manipulating Key Design

In a paper by H. J. H. Wassell in "The Marconi Review," for July-September, 1946, on the above subject, general consideration was given to problems of hand keying, together with some detailed observations of keying methods.

The factors which influence good keying are:—

(a) Transit Time.—That is time required to move from upper contact to lower contact. This should be less than one tenth of the dot time.

(b) Transverse vibrations in the bar of the key.—These may be set up "following" the moment when impact occurs at the contact and tend to confuse the operator.

(c) Natural period of oscillation as a pendulum.—This should be long in comparison to the transit time experienced at the slowest speed of sending.

(d) Placement of contacts at the centre of percussion.—This ensures that the reaction on the pivots at the moment of the impact between the contacts is a minimum.

(e) Locus of the knob.—Since in keying the movement of the hand tends to be in a circular arc centred on the wrist or elbow, it is desirable that the locus of the knob should coincide with this arc. The nearest mechanical feasible approach to this ideal is a vertical up-and-down motion, which can be approximated by the use of a large radius from pivot to knob.

These factors lead to the following conditions, which should be met by a well-designed key:—

- (i) Small mass of moving arm.
- (ii) The use of a "dead" metal for the arm, so as to damp out transverse vibrations.
- (iii) The use of an arm length not less than  $2\frac{1}{2}$ " , but not greater than is necessary so that transverse vibration amplitude is low.
- (iv) Small gap, having regard to electrical loading.
- (v) Contacts at or near centre of percussion.

**Comments of Operators.**—A considerable number of keys of different types were set up and adjusted by individual operators who were asked to comment on each key and state reasons for their preferences.

Most operators said they preferred a key which had a "definite" feel and disliked a key which had a "woolly" feel. This definiteness would seem to be a mixture of a desire for little or no follow through of the key once the contact has been reached, combined with an absence of spurious vibrations.

Thus from this point of view a really bad key would have a large

mass with spring supported contacts. Another property which operators appreciate is that of "liveliness." This would seem to be a property given to a key by minimum mass and minimum frictional resistance. Another expression used by operators was that at high speeds "the key should send for you." By this it is thought that the operators mean that there should be no disturbing resonances which would introduce forces in opposition to those necessary to manipulate the key, and that if the force applied to the key is not truly vertical, the movement of the key should still substantially be in the right direction.

**Details of a New Key Design.**—Having regard to the above considerations a new key was designed. Some details of this key are as follows:—

- Total weight—1 lb. 3 oz.
- Mass of moving arm (less pivot bar)—2 oz.
- Length between knob and pivot— $3\frac{1}{4}$ "
- Height of knob skirt above the bench— $1-1/16$ "

Some of the design features are outlined below:—

(1) Bearings.—Spring loaded knife bearings are used as these do not require adjustment for wear, and bearing friction is satisfactorily small. The contacts are so placed that the pressure on the bearing surface is maintained irrespective of whether the knob is pressed down or pulled up.

(2) The gap adjustment is controlled by means of a nut on the actual knob mounting. This nut is turned by moving the skirt of the knob which carries a scale on its periphery to allow rapid re-setting to a predetermined value. The skirt is locked in position by the knob itself.

(3) Knob Height and Shape.—The knob shape was chosen as a result of the preferences expressed by operators using previous keys. There was an overwhelming preference for a skirt to be fitted to the knob. The top of the knob is patterned to avoid slipping in damp climates.

(4) Click Suppression Filters.—Except for the operating knob and the tension adjusting knob, the key is completely enclosed by a streamlined casing. It has been possible to incorporate within this casing a filter which supplies the minimum amount of filtering necessary to satisfactorily suppress any spark interference.

(5) Bench Mounting.—A bottom plate is provided for the key which can be screwed down to the bench and to which the key can be fastened by a single securing screw.

## SUCH NICE PEOPLE (Continued from Page 11)

Henry, 3EN, had fire in his eye one night on 7 Mc., splashing a fair treat. Not usual for you OM, what was it, homework?

\* \* \* \* \*  
Pretty chirpy stuff from 3NJ on 7 Mc. 2GS not quite so bad, but room for improvement.

\* \* \* \* \*  
Those with clicks to a varying degree, but otherwise OK—3JP, 2ML, 3BP, 2VW, 3FH and 3AIR. While on clicks, the Type 3 Mk. 2 is not immune. Click filter built in I know, but it's not 100% pure.

\* \* \* \* \*  
Now the fone blokes. 3GK, a solid hum plus a splash. 3ABJ pretty rough. 2NJ, a very solid hum, one of those jobs that stops when you speak. Bit hard to talk all the time so I guess the only thing to do is clean it up. 3FW, your background music was solid at 1415 on July 6. You and the music just about broke even at times.

\* \* \* \* \*  
Those that just splash—3AO, 7MR, 2AIK, 2ML, 3FW, 4FW, 3BU, 3ZU and 2NL.

\* \* \* \* \*  
You've gotta be quick these days. Couple of months back I mentioned I wouldn't be surprised if the Federal President took to the air. Between the time of writing and hitting print, a new hand was holding the reins from the Federal seat. I know everyone will join with me and say how sorry we are to see you go Vaughan. Thanks for guiding us through difficult times. To the new chief, greetings. We should have no worries—nothing like an old dog for a hard road, you know!

---

Unofficial Q signs used by 6WH so that he does not get the OM in trouble with the XYL are: QWG (weeding garden), QWC (wood chopping), QWD (washing dishes), QMT (meal time).

---

**FOR SALE,  
EXCHANGE, WANTED**  
9d. per line, minimum 2/-

---

**WANTED TO BUY.**—QSTs, September 1942, August 1943. R. Graf, 27 Anderson St., Newport, Victoria.

---

**WILL EXCHANGE** new 100TH for quantity of 7193s, 9072s, 2C22s or CV6s, or best offer. Ring R. J. Bell MB 1995 (during business hours).

---

**FOR SALE.**—Azimuthal Map of the World, 12 inches diameter, centred on Sydney. Just the thing for VK2, 3, 5, 7 and south VK4 Hams and SWLs, especially for directing those beams. Price 7/6 each. Postage free, delivery within 14 days. J. L. Lewis, 810 Ligan St., Ballarat, Vic.



**REMEMBER . . .** you get the **MOST** satisfaction  
from

## **LAWRENCE & HANSON**

# **• RADIO PARTS •**

### **Need We Remind You**

. . . that during the years of Radio history we have followed with much interest and pride the remarkable progress, ingenuity, skill and enthusiasm of you—the Amateur Broadcasters of Australia.

As enthusiasts of a fascinating hobby, you have perhaps graduated to bigger and better things in radio, or maybe, you're quite content to remain enthusiasts and get the most from your set.

And that's what interests us—**getting the most from your sets!**

Ever since radio was in its infancy, many amateurs have relied solely upon

### **LAWRENCE & HANSON RADIO PARTS**

— the high quality radio components renowned for their long years of unflinching, dependable service. Moreover, L. & H. have the widest possible range of radio parts found anywhere. Look around town—you just can't get a more selective, more reliable, more satisfying range!

**For dependable radio broadcasting equipment  
rely on—**

### **LAWRENCE & HANSON RADIO PARTS**

Obtain latest lists and prices from your radio house!

Here's a list of  
**L. & H. Radio Com-  
ponents that's sure to  
interest you!**

- \* Microphones
- \* Batteries
- \* Switches
- \* Vibrators
- \* Chokes
- \* Condensers
- \* Coils
- \* Meters
- \* Valves
- \* Transformers
- \* Chasses
- \* Speakers

Technical Advice given  
on request.

## **LAWRENCE & HANSON**

### **ELECTRICAL PTY. LTD.**

33 YORK STREET, SYDNEY.  
120 COLLINS STREET, HOBART.  
87 ELIZABETH STREET, BRISBANE.

172 WILLIAM STREET, MELBOURNE.  
60 WAYMOUTH STREET, ADELAIDE.  
20 PATERSON STREET, LAUNCESTON.

# Here's **PORTABLE** pleasure



It's a little beauty! The Aegis Voyager is a compact, efficient 4-valve battery-operated portable supplied in kit set form. Every part, including the miniature valves and Mini-Max batteries, comes to you in a well packed carton, all ready for assembly—and it's so easy to do with the complete instructional details. When finished it is only 8" x 6½" x 7" and every feature is typical of Aegis quality and ingenuity of engineering. This is the first kit set to be fully licensed by A.R.T.S. & P. which gives you full use of all patents... yet another triumph for Aegis.

with the  
**AEGIS 'VOYAGER'**



#### FEATURES OF MODEL KP4.

**WEIGHT** 12 lb. assembled  
(packed for despatch—  
14 lb.)

**BATTERIES:** Genuine Ever-  
ready Mini-Max B. Bat-  
teries giving approx. 240  
hours life.

**RADIOTRON** miniature  
valves allowing for extra  
sensitivity and space-  
saving.

**ROLA** 3½" Per-Mag. Spea-  
ker.

**CABINET** durable Leather-  
ette covering.

**AEGIS** special Loop Aerial  
for high Q.

**AEGIS** J10 I.F.'s.

**CHASSIS:** Cadmium plated

# AEGIS

MANUFACTURING CO. PTY. LTD.  
MELBOURNE · AUSTRALIA

RETAIL PRICE  
in all Capital Cities  
**£16/17/6**  
(including Valves  
& Batteries)  
Attractive Discount  
to Amateurs.

Distributors in all States include:—

MELBOURNE: Replacement Parts Pty. Ltd.  
J. N. Magrath & Co.  
Lawrence & Hansen Pty. Ltd.  
John Martin Radio and Electrical  
Pty. Ltd.

SYDNEY: John Martin Pty. Ltd.  
Geo. Brown Pty. Ltd.

# AMATEUR RADIO

SEPTEMBER  
1947

JOURNAL OF THE WIRELESS INSTITUTE OF AUSTRALIA

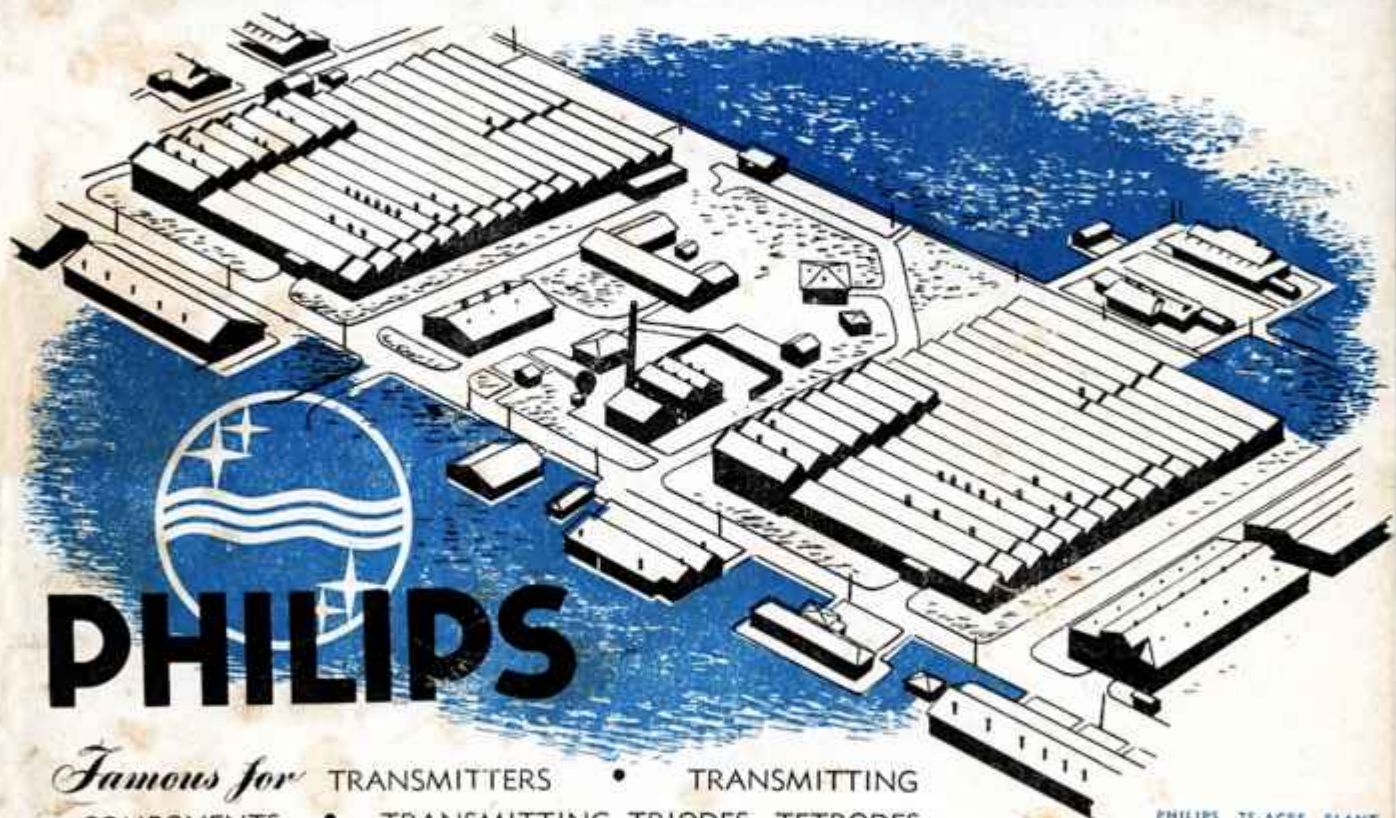

# PHILIPS

*Famous for* TRANSMITTERS • TRANSMITTING  
COMPONENTS • TRANSMITTING TRIODES, TETRODES  
AND PENTODES • HIGH VACUUM AND MERCURY  
VAPOUR RECTIFIERS

PHILIPS 35-ACRE PLANT  
AT HENDON, SOUTH AUS-  
TRALIA. THREE PHILIPS  
FACTORIES ARE COM-  
BINED IN THIS MODERN  
PLANT.

PHILIPS ELECTRICAL INDUSTRIES OF AUSTRALIA PTY. LTD.

SYDNEY

MELBOURNE

ADELAIDE

PERTH

BRISBANE



FOR THE EXPERIMENTER & RADIO ENTHUSIAST

Registered at G.P.O., Melbourne, for transmission by post as a periodical.

6<sup>d.</sup>

# *Kingsley again with something NEW!*

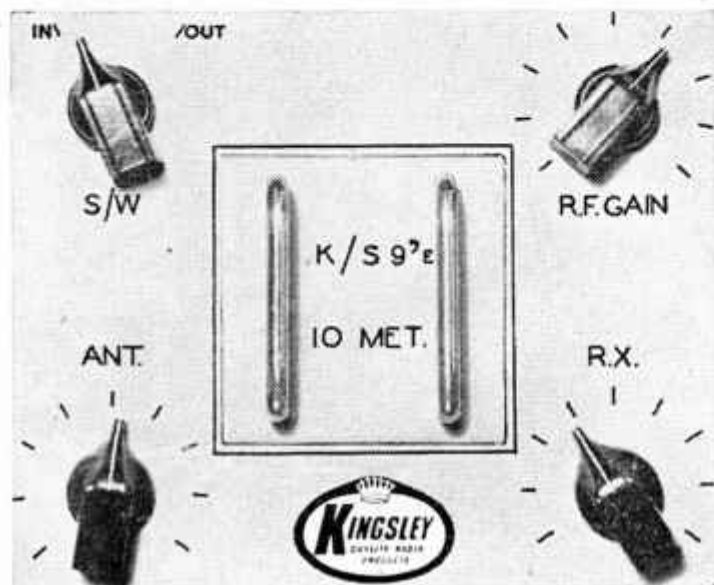

Typical of Kingsley's progressive post-war programme, is this outstanding signal-strengthening unit. Kingsley's forward vision in radio has produced some of the most outstanding advancements in Australian Radio, and will continue to do so. For the very best in radio equipment — keep your eyes on Kingsley.

**The 'KS' 9'er.** This unit is designed to bring weak signals to the 9 level. The circuit consists of a system permitting matching to the antenna and to the receiver . . . this match is adjustable. Two inductances for each band are tuned with Iron Cores. A worth-while addition to the 'Ham' Station . . . designed with two coil boxes—one for 10 Metre operation and one for 6 Metre. May be ordered either with or without Coil Boxes.

**ORDER FROM ANY KINGSLEY DISTRIBUTOR.**



## **KINGSLEY RADIO**

**KINGSLEY RADIO PTY. LTD.**

**380 St. Kilda Road, Melbourne, Victoria . Phones: MX 1159, MX 3653**

SEPTEMBER — 1947

Vol. 15 No. 9

**Editor:**

T. D. HOGAN, VK3HX.  
Telephone: UM 1732.

**Technical Editor:**

J. K. RIDGWAY, VK3CR.

**Notes Editor:**

R. W. HIGGINBOTHAM, VK3RN.

**Distribution:**

H. N. STEVENS, VK3JO.

**Business Manager:**

J. G. MARSLAND, VK3NY.

**Advertising Representative:**

W. J. LEWIS,  
20 Queen Street, Melbourne, C.I.  
Telephone: MU 5154.

**Printers:**

H. HEARNE & CO. PTY. LTD.,  
285 Latrobe Street, Melbourne.

MSS. and Magazine Correspondence should be forwarded to the Editor, "Amateur Radio," Box 2611W, G.P.O., Melbourne, on or before the 15th of each month.

Subscription rate is 6/- per annum, in advance (post. paid).

— IN THIS ISSUE —

Clearing the Ether .....	3
Amateur Television .....	5
Federal Notes .....	11
"Such Nice People" .....	12
Federal QSL Bureau .....	12
Fifty and Up .....	13
Correspondence .....	14
Divisional Notes .....	16
Care of Indicating Meters .....	27
Plastics in Television Optical Systems .....	28
807 as High-Mu Triode .....	28
Selection of Valves for use as Cathode Followers .....	28

# AMATEUR RADIO

Published by The Wireless Institute of Australia,  
Law Court Chambers, 191 Queen Street,  
Melbourne, C.I.

## EDITORIAL



Now that Frequency Modulation and Pulse Transmission is available to the Radio Amateur, it is important that those who intend to make use of these types of transmission, be cautious in their approach to the technical questions involved, before constructing equipment which may not be suitable for operation with other stations.

Whilst the technical problems associated with Frequency Modulation are fairly generally known, the technique of Pulse Transmission is not so simple nor are there many technical references available on the subject to facilitate experimental work in this field. It is important therefore that we determine standards of operation such as deviation ratios, audio-frequency limits, frame sizes, pulse lengths, pulse synchronizing, peak powers and other important details, as become apparent to those who really study these fascinating fields of experimental activity.

Apart from the necessity for determining standards of operation, it is vital for the Radio Amateur to provide himself

with an accurate method of frequency measurement for the bands concerned, together with suitable test equipment, to ensure that his transmitting and receiving equipment is functioning correctly.

A great deal of time and effort, as well as considerable money, will be saved by those who think carefully, study diligently, and plan sensibly before commencing to use such methods of operation.

Your Federal Executive is seeking a definition of British and American standards of operation, and will endeavour to set out in next month's editorial, suitable standards of operation for Australian Radio Amateurs, which will be in line with the methods adopted in other countries.

In succeeding issues of Amateur Radio, we will also provide food for thought in regard to Frequency Modulation and Pulse Transmission, by the provision of technical articles on both subjects, together with descriptions of suitable test equipment for use with each method of operation.

W.R.G.



# Homecrafts

## FOR BETTER VALUE

### DISPOSAL VALVES AT REDUCED PRICES

- ★ E.F. 50 High Gain R.F. Pentode ... 17/3
- EA50 Single Diode ... 17/3
- VCR 87 6" Cathode Ray Tube 37/6 plus Sales Tax
- 41 MXT Output Pentodes ... 14/-
- 807 Beam Power Pentodes ... 16/6
- VCR 112 5" Cathode Ray Tubes 30/- plus Sales Tax

### ★ JUST LANDED! American Universal MICROPHONES

- The following types are ready for immediate delivery.
- 212 A Dynamic ... £11/0/0
  - D 20C Dynamic ... £11/12/6
  - 308 Dynamic ... £9/15/9
  - 808 Velocity ... £9/15/9
- All complete with 40,000 Ohm Matching Transformers

### ★ TELEPHONES

READY FOR IMMEDIATE DELIVERY Brand New Army type Intercommunications. Will give perfect 2-way communication from home to outbuildings—from house to garage or to neighbouring farm—ideal too for factories, large buildings, etc. Write for leaflet.

**£2/2/-**  
Batteries, 5/-

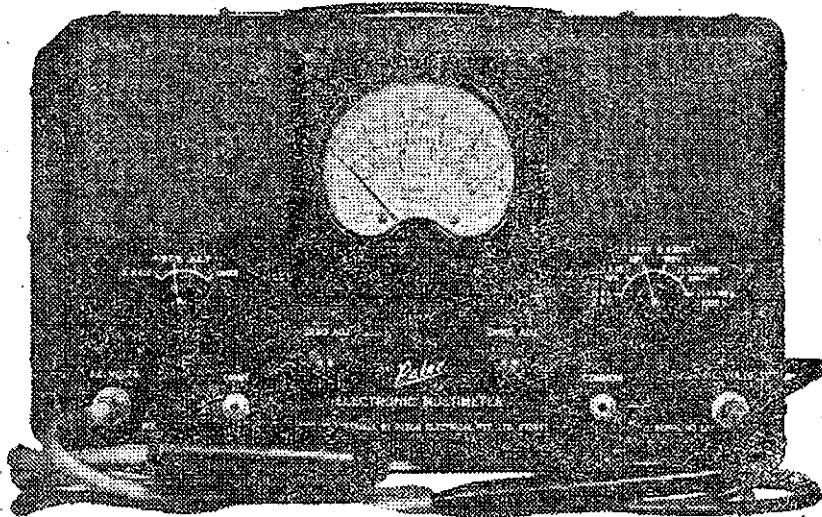
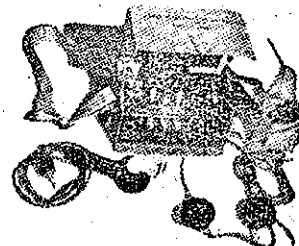

### THE LATEST IN RADIO TESTING EQUIPMENT "PALEC" VT (Probe) MULTIMETER MODEL V.T.M. As Illustrated at left

Every Amateur will find this the most useful test instrument yet devised. Write us for full particulars. This is a Winner! **£29/10/-** and only plus Sales Tax

**MAGNETIC PICK-UPS 25/6**  
5-way Battery Cable  
6d per yard.

10,000, 20,000 and 30,000 Ohm.  
**BRADLEY**

**POTENTIOMETERS, 1/11**

### PORTABLE AMPLIFIERS, £22

Complete with Valves, 8" Speaker and Microphone and Stand.

12 Volt GENERATORS 12 Gns.  
Will charge up to 100 Amps. Output

### 2 Gang Condensers, 7/6 MULTIMETERS

with 10 Ranges housed in Black Crackle Finish Cast Aluminium Case  
£6/19/6

Dry Battery POWER supply UNITS for MCRI Commando Receivers 12/6

## HOME CRAFTS PTY. LTD. The Radio & Electrical Specialists

Head Office ... MELBOURNE, 290 Lonsdale Street, and at—

211 Swanston Street, Melbourne. 307 Sturt Street, Ballarat. 139 Moorabool Street, Geelong. 121 Pirie Street, ADELAIDE.  
100 Clarence Street, SYDNEY. 26 Hunter Street, Newcastle. Hobart, Launceston and Burnie, TASMANIA.

# CLEARING THE ETHER

## Series II, Part XI

By G. GLOVER\*, VK3AG

### THE MODULATOR UNIT

The major requirements of the ideal modulator are:—

(a) It must be capable of reproducing faithfully, in amplified form, all signals fed into its input terminals. Thus, in order to provide wide scope for experimentation the modulator unit, unlike the speech amplifier, should be designed to provide uniform response over the widest possible frequency band.

(b) Output impedance must be sufficiently flexible to allow unit to be coupled to modulated amplifiers having a wide range of input impedances, thereby facilitating experimentation.

(c) It should be possible to read cathode currents of individual tubes by means of switch and common meter.

(d) Unit must be capable of easy removal in order to facilitate its use either in rack or on bench as required.

in the region of nil distortion; however this is hardly economical or necessary unless special requirements have to be met.

There are several ways in which we can attack the problem of providing required modulating capacity, such as:—

- (1) Using tubes large enough to cope with power requirements under Class A conditions.
- (2) Using smaller tubes in push-pull-parallel arrangement under Class A conditions.
- (3) Using small tubes in push-pull and driving same into Class AB<sub>1</sub>, AB<sub>2</sub>, or B region, in order to obtain required power.

**Output Impedance.**—The best method of attacking the variable output impedance problem is by using a multi-ratio transformer, provided that the transformer is properly designed, and due allowance has been made for unbalanced d.c. flowing through secondary, loss of fidelity should be within permissible limits.

modulator unit, and the writer now proposes to outline one method of attacking the problem.

### THE PRACTICAL MODULATOR UNIT

Figure 17 is schematic circuit diagram of modulator unit about which our discussion will be focused. In this case four 807 type tubes are employed in push-pull-parallel circuit capable of fully modulating 100 watt transmitter. Wasteful you think, may be insofar as tubes are concerned, but in view of the comparatively low cost of type 807 tubes and freedom from distortion, quite warranted. Naturally for 50 watt rig only one pair of 807s will be required. It is with a view to allowing for flexibility of power output rating, that the individual tubes are self stabilised and adequately isolated. Furthermore the circuit lends itself to easy changes, for instance, if so desired the resistance-capacity coupling network between stages may be replaced by transformer.

In practice it is questionable whether the use of beam-tubes in modulator unit is warranted, because although the driving power required is much less than that required for triodes under normal circuit conditions, by the time adequate negative feed-back has been applied to counter inherent distortion of former, much of this gain disappears; still

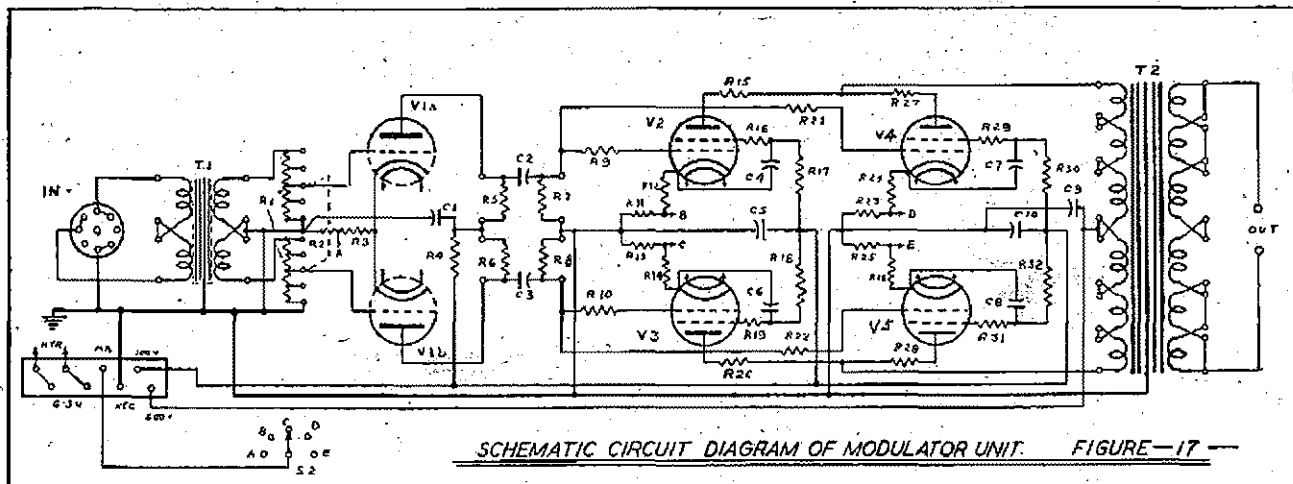

T1—600/100,000 ohm Input Transformer.  
T2—50 or 100 watt Multi-Match Modulation Transformer.  
V1—6SN7.  
V2, 3, 4 and 5—807.

C1, 5, 10—8 mfd. Electrolytic Capacitors 525 v.w.  
C2, 3—0.1 mfd. 600 v. tubular paper.  
C4, 6, 7 and 8 see text.  
C9—4 mfd. 1,000 v.w. paper.  
R 1 and 2 see text.

R3—700 ohms, 1 watt, Carbon.  
R4—10,000 ohms, 1 watt, Carbon.  
R5, 6—50,000 ohms, 1 watt, Carbon.  
R7, 8—0.1 Megohm, Carbon.  
R9 to R32 see text.

**Power Capabilities.**—The modulator unit must have sufficient power handling capacity to provide 100% modulation of modulated amplifier before distortion exceeds permissible value. Naturally if we have a large pocket and are idealists we may construct our modulator with large enough power margin to operate it

By employing a number of pies in both primary and secondary, and connecting same either in parallel or series, it should be possible to incorporate the highest inductance possible for a given impedance ratio, while at the same time eliminating the necessity for unused pies.

the 807 seems to be the popular choice at present, so our story has been built around same.

The simple stabilisation circuit shown will not provide sufficient feed-back for wide-band operation, but does provide effective stabilisation of individual tubes over normal operating range; furthermore as previously mentioned one pair may be

\*Glorad Engineering Services.

**Summary.**—To date we have considered general requirements of the

removed without upsetting operation of circuit, apart from change in plate to plate impedance, which is naturally doubled when one set of tubes is removed.

Where wide band operation is required it is suggested that recourse be made to circuit employing pentode type tubes, such as 6SJ7G, in first stage and applying feedback to screen circuit thereof. The object being to allow more scope for frequency correction circuits.

If operation of output tubes in Class AB<sub>2</sub> is contemplated, for the purpose of increasing output, then two modifications must be borne in mind. Firstly, as fixed bias will be required the stabilisation circuit depicted will have to be replaced by type discussed in foregoing paragraph. Secondly, resistance-capacity interstage coupling will have to be replaced by transformer, and value of grid stopper resistors reduced. The necessity for change to transformer being brought about by the presence of grid current during the positive excursions of the driving voltage. Sounds awfully simple does it not? But, there's a catch in it! You've guessed it, the transformer is the nigger in the wood pile. Apart from the necessity of cross connecting the feed-back circuit to cope with 180° phase reversal in the transformer, it is necessary to employ network to correct phase-shift at extremities of frequency range. The same story applies to Class B operation. All of which adds up to the fact that attacking the problem from a conservative angle pays dividends in simplicity and bug free operation.

**Electrical Aspects of Unit.**—By referring to figure 17 the reader will note that the first salient feature is the balanced step by step gain control. For simplicity sake the drawing depicts same as having only five contacts, in practice an eleven position, two pole, two section wafer switch is employed in conjunction with  $\frac{1}{2}$  watt carbon resistors. Each step representing a change of 2 db, giving a total of 18 db variation prior to cut-off or infinity position, sufficient to cope with most needs. In fact if greater range is required it is desirable to insert small fixed attenuator pads in line between the speech amplifier and modulator. The value of 2 db quoted above is merely arbitrary as it may not be possible to select carbon resistors of exact value required, in which case the nearest value should be employed and the value of next resistor modified to maintain total resistance of "stick" at selected value. The experimenter who insists on a high degree of accuracy will find his time fully occupied selecting resistors of the correct value; however provided corresponding resistors in each "stick" have a value within 5% of each other, slight modifications in other directions will not be troublesome.

Table below gives exact and suggested values for 50,000 ohm "stick."

Resistor	Exact Value	Suggested Value
Top	10,285 ohms	10,000 ohms
2nd	8,165 "	8,500 "
3rd	6,490 "	6,500 "
4th	5,155 "	5,000 "
5th	4,095 "	4,000 "
6th	3,250 "	3,500 "
7th	2,585 "	2,500 "
8th	2,050 "	2,000 "
9th	1,630 "	2,000 "
Bot.	6,295 "	6,000 "

From the above table it is obvious that we have been able to rationalise values of required resistors with an error of less than 0.5 db. This fact is mentioned for the benefit of those experimenters who insist on regarding anything associated with the humble db as black magic.

**Interstage Coupling** is drawn in such a manner as to readily indicate how transformer connections would appear. When using transformer, R7 and R8 are replaced by resistors of the correct value required for the impedance of transformer chosen. Even when output tubes are operating in Class B or AB<sub>2</sub> condition resistors are required, in order to reflect finite loading during negative swing of driving voltage, otherwise parasitic oscillation is apt to start in the quiescent tube. In general a step up transformer will be required for Class A or AB<sub>1</sub> operation; whereas a step-down transformer will be required for Class AB<sub>2</sub> or B operation. In the latter case the power handled by the driver tube is considerably greater; therefore low impedance triodes of the correct power rating operating in Class A are to be recommended for driver stage. Unless of course the user, through sheer cussedness, insists on trying cascaded Class B stages, with consequent risk of much splatter.

**Grid Stopper Resistors R9, R10, R21 and R22.**—These items are very important factors in the suppression of parasitic oscillation, and their value for Class A and AB<sub>1</sub> operation may be as high as 10,000 ohms, on the other hand for Class AB<sub>2</sub> and B operation value must be kept as low as stability will permit, under no circumstances should the value exceed 500 ohms.

**Screen Stopper Resistors R16, R19, R29 and R31** are connected right at the tube socket to prevent parasitic oscillation in the screen-anode circuit and have a value of from 50 to 100 ohms.

**Anode Stopper Resistors R15, R20, R27 and R28** should be incorporated in the anode lead right at the tube cap, in order to ensure maximum isolation of tubes. If any signs of splatter are noticed 100 pfd. high voltage mica capacitors may be connected between tee of the two stopper resistors and ground in each case. The value of anode stopper re-

sistors should be the same as for screen stoppers.

**Stabilisation Circuit.**—Each tube has associated with it a stabilisation network consisting of 500 ohm cathode and screen resistors, and feed-back capacitor of 0.5 mfd. (paper) value. The object being to feed back to cathode circuit sufficient out-of-phase energy from the screen circuit to stabilise the tube. For example the stabilisation circuit for V2 consists of R12, R17 and C4.

**Output Transformer T2.**—This item is drawn in the manner shown with a view to illustrating method normally employed for series or parallel connection of pies.

**Metering** is accomplished with the aid of five position single section wafer switch and shunts in the cathode circuits of individual tubes. In order to save the expense of including meter in modulator panel the wiring is so arranged that while tube to be metered is selected by switch on panel the actual meter may be located on the common control panel, or wherever it may be desired to locate same. R2 has a value of 11 ohms and provides full scale deflection of 10 Ma. on 0-1 Ma. meter having internal resistance of 100 ohms. R11, R13, R23, R25 each have a value of 1.0 ohm thus giving full scale deflection of 100 Ma.

If considered desirable the switch may be extended to read screen and anode supply voltage, in a manner similar to that shown for "Speech Amplifier." Furthermore a blank position can then be provided for switch; thus eliminating any possibility of feed-back due to it being left in position where energy can be transferred between panels.

**Mechanical Aspects of Unit.**—In general the layout and design of unit may follow closely the design depicted for the Speech Amplifier in Part X of this series. It is suggested however that the plug and socket connections for the power on this unit deserve careful consideration. If the usual tube socket and base type fitting is to be employed care must be exercised to use say 6 pin assembly with contacts in parallel for heaters, and 4 pin assembly for h.t. and metering circuits. The type of fitting depicted in diagram has particularly robust contacts.

**Final Summary.**—In some instances the writer has diverged from the actual unit under discussion to comment on other aspects of operation, the object being to kill two birds with the one stone; hence it is hoped that such divergence has clarified, rather than clouded, the atmosphere. One point which has not been mentioned and that is the possibility of r.f. creeping into the unit. In such cases the application of 0.01 mfd. mica type capacitor in shunt with existing capacitor will do the trick.

# AMATEUR TELEVISION

By G. S. B. HORROCKS\*, VK6GS

High Definition Television is an accomplished fact in England and America. It is a matter for conjecture as to how long it will be before we have it in Australia. It appears to be the general opinion among Engineers that Australia should select the best system that either England or America can devise. With this, I heartily agree. However, there seems to be an all or nothing idea about the whole business which I think is regrettable.

## HIGH AND LOW DEFINITION

Television overseas, started from very small beginnings, using the crudest of apparatus. Although a Low Definition Picture has very little entertainment value, from the broadcast listener's point of view, that should not deter the keen experimenter who is generally much more interested in the technical side. Also, by constructing Low Definition apparatus, it will be possible for the Ham to get some practical experience with Television, while waiting for the introduction of a High Definition Service.

Low Definition apparatus can be built by the Amateur, and, if certain parts were to be put on the market at a reasonable price, quite good pictures could be obtained. I have in mind transmitters of the mechanical optical type, which are fairly easy to construct. Fair definition is possible if the subject matter for transmission is restricted to either Film or Lantern Slides.

Television transmissions may be divided into two distinct types, namely, Direct Pickup and Telecine. Direct Pickup refers to the method of transmission, by which light reflected from the subject is directly converted into a television signal. A Telecine system requires the use of an intermediate film, upon which the scene or persons which have to be televised are first photographed by a movie camera, and the film after processing, is fed into the projector of the Telecine transmitter. The resulting video and sound signals are then broadcast in the same manner as those from a direct pickup transmitter.

Direct Pickup Transmissions are practically instantaneous, while there is a time lag with a Telecine Transmission. Standard cinematograph films may be broadcast by a Telecine Transmitter. If only still pictures have to be televised, lantern slides may be used in the place of film.

Direct Pickup Transmissions can be by either of two different methods; "Floodlight" and the so called "Flying Spot" system. With the first, the subject is illuminated by a powerful

flood light. Flood light transmission is invariably used with Electronic Pickup tubes, such as the Iconoscope. With Mechanical Transmitters, the flying spot (of light) method of scanning is generally used. In this case, the subject stands in semi-darkness. Some of the light, reflected from the flying spot which scans the whole field of view, line by line, is collected by the photo cells, which are arranged in such a manner, as to get a picture of suitable contrast.

Unfortunately, mechanical scanning is unsuitable for either high or medium definition, particularly when a large subject such as a living person or an extended scene has to be scanned.

In the case of low definition, where the picture is composed of less than, let us say, a hundred lines, mechanical transmitters can give good results and have the great virtue of cheapness.

With a mechanical transmitter it is possible to transmit, by direct pickup, a head and shoulders view with a definition of at least 60 lines. This may be done by using a Mirror Drum in conjunction with an oscil-

lating mirror for scanning. A car headlight globe may be used for a light source.

I am not at present interested in the radio transmission of television as in my case, the production of video has been a full time job, and it will be some considerable time before I am in a position to do so (Wireless Branch permitting).

Television has, of necessity, to be broadcast on very high radio frequencies, this is due to the very large bandwidth required if there is to be no loss of detail.

A 60 line picture, if transmitted by radio, would need a bandwidth of approximately 50 Kcs., while a little over a 100 Kcs. would be needed for a 90 line picture. This is a fair slice of any Ham Band, though I expect it would be no more than that required for a super-regenerative receiver. High Definition would require a very large bandwidth; 6 Mcs. for the American 525 line standard. This should rule out High Definition Radio Transmission by Amateurs on the present allocation of frequencies.

## RECORDED TELEVISION

It was around 1935-36 that I began to take a serious interest in television. The fact that I was unable to re-erect at my present address the 90' mast which I had at Naremben, did much to make me abandon Amateur Radio for something different. I was subscribing to "Television and Short Wave World" and the articles in that excellent magazine also helped to switch my interest to Television. In 1936, I bought from a local firm a Recorded Television Record. This was recorded on an ordinary gramophone record, of a television broadcast on the old BBC 30 line standard. To get a picture, it was necessary

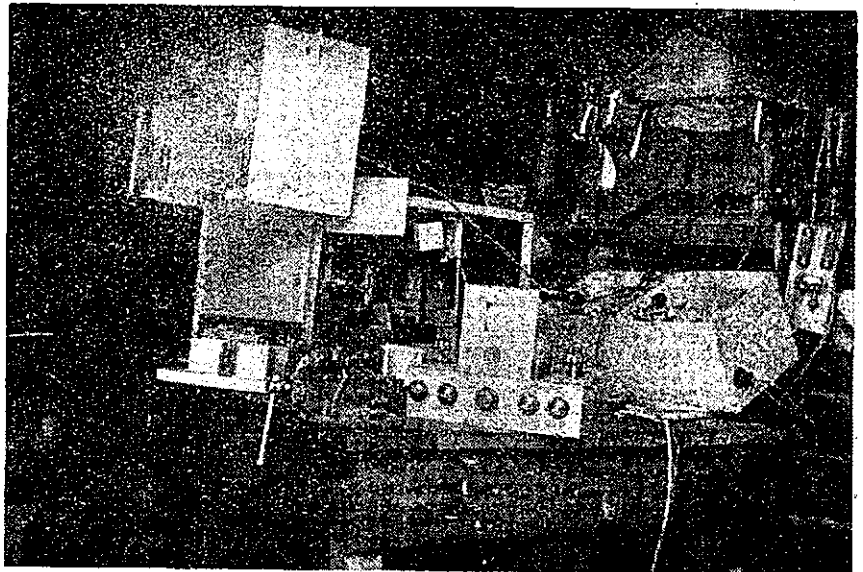

Direct Pickup Mirror Drum Transmitter in foreground. Transmitter Scanner is laying on its side to show the works.

\*Uduc Road, Harvey, W.A.

to run the record at a speed of 78 r.p.m. The output from the pickup and amplifier modulated a 5 watt neon lamp. In front of the neon lamp was placed a scanning disc. This scanning disc had 30 holes. These holes were arranged in the form of a spiral, with a spacing of 12° between the holes. This disc, when revolving at a speed of 750 r.p.m. and synchronised to the record, enabled the signals fed to the neon to be sorted out into their proper place in the picture, by only exposing the neon lamp, to that part of the picture which corresponded with the little bit of detail, that happened to be in the same part of the original subject matter scanned by the transmitter in the BBC studios, and then recorded on the record. This apparatus was designed to scan the picture in a vertical direction, and had a height to width ratio of 7 to 3. This record was synchronised to the scanning disc by carefully adjusting the speed of either the disc or the gramophone motor. With this record, and the very crudest of scanning apparatus and an amplifier designed for anything but television, I was able to get pictures which were at least recognisable as being those of men and women.

### TELEVISION WITHOUT SYNCHRONISING

But the question which I kept on asking myself was "Would it be possible to have Real Television and not merely the recorded stuff?" There was only one way to find out, and that was to try.

Most of the available literature on television was about how to receive Broadcast Pictures, and very little of it was written about the building of your own transmitter. The usual method was to use a Scanning Disc or a Mirror Drum for transmission, and a separate Disc, Mirror Drum or Cathode Ray Tube for reception. The Nipkow Disc was the obvious choice for me as a beginner.

The difficulty of synchronising two separate scanning discs, had me worried, as I had no suitable driving motors. One method of overcoming this difficulty would have been to mount both discs on a common shaft, and to drive them by an electric motor at the speed of 750 revolutions per minute. I then thought of an even simpler method. Why not use the same disc for both transmission and reception? The reader may complain that this would defeat the main object of Television—the ability to see at a distance. However this experiment was intended to ascertain the possibility of generating a signal which would give a picture when resolved by suitable receiving apparatus. Also, as both the transmitter and receiver would in this case be mounted on the same table, it was obvious that nothing would be lost by using one disc for both purposes, and the elimination of syn-

chronising problems would do away with many possible causes of failure.

I therefore proceeded as follows: The receiving side of the scanning disc, with its neon lamp, was arranged in a manner similar to that used for recorded television. On the diametrically opposite side of the disc I mounted a light condenser and a projection lens, both borrowed from a magic lantern. An electric light globe was used as a light source. With the lenses properly focused, and the disc revolving at 750 r.p.m. a scanning raster of 30 lines was visible on a screen, placed a few feet from the scanner. I found it necessary to add to the scanning disc an extra half circle of holes, as it is apparent that there is a displacement of half the picture width between any scanning strip, or line, in the transmitter and the corresponding strip exposed by the receiver.

For example, with a 30 line picture, No. 1 scanning aperture in the transmitter would be exposed at the same time as No. 16 aperture in the receiver. If an extra 15 holes are added to the disc, so as to continue the

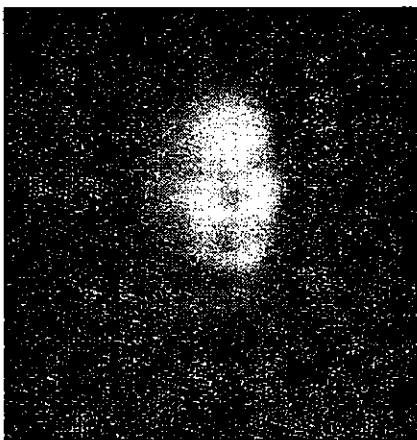

Unretouched approximately full size of image on 3" Philips DG71-G cathode ray tube.

spiral of aperture for another half turn around the disc, it is possible to use holes from No. 1 to 30 inclusive for transmitting, and holes No. 16 to 45 inclusive, for receiving. A mask was used to cut off the unwanted apertures, as only one aperture may be exposed at a time.

Having arranged the dual purpose scanning disc as described, I connected the neon lamp (Osglim 5 watt) in place of the loudspeaker of a public address amplifier and plugged a photo cell into the microphone input socket. An inverted jam tin, with a hole cut out in its side to admit light, was placed over the photo cell as an electrostatic shield.

Everything was switched on and the photo cell tested for response, by flicking a weak light into it. The photo cell was placed about a foot from where the scanning raster of the

transmitter came to a focus, so as to pick up light reflected from the flying spot. Everything was ready for the first test. I placed my hand in the scanning beam from the transmitter, nothing happened! I tried a piece of white blotting paper, still no result. I then tried a shiny piece of metal.

At last! A bright spot was seen when viewing the neon through the revolving scanning disc. This bright spot in the receiver moved across the field of view in sympathy with any movement of the shiny piece of metal held in front of the transmitter.

My first attempt to use reflected light for transmission by direct pickup was not a success, so my next idea was to try silhouettes.

A handkerchief was placed where the scanning beam came to a focus, to act as a diffusing screen. (A ground glass screen, such as can be bought from a toy shop, would have been better.) The photo cell was placed behind the screen. A 4" diameter lens between the screen and photo cell increased the light pickup. This arrangement gave sufficient response to fully modulate the neon, i.e. between black and white (actually between red and black).

The pictures obtained with this set-up were anything but satisfactory owing to a phenomena which I will now describe as it should prove of interest to anyone who may contemplate the construction of any television apparatus.

If the fingers of my hand were held apart and placed just in front of the screen so as to be in the scanning beam, they appeared as four shadows in the receiver. However, on bringing my fingers together until they touched, of the four fingers formally visible in the receiver, only one remained. The position of the first finger would be marked by a sudden change from red to black. This blackness, however, quickly faded out, and merged into the background about where the second finger should appear.

This made me realise that the low frequency response of the amplifier was quite inadequate. A specially constructed amplifier was need, with a level voltage output, down to below audio frequency.

### SPECIAL AMPLIFIER

After searching through the back numbers of "Television" I found what I considered to be a suitable circuit, which I modified, so as to enable me to use battery valves and batteries, for at that time I had no a.c. power supply.

The amplifier had three stages of R.C. coupling, screened pentodes with 30,000 ohm anode resistances and large coupling condensers. The output of this amplifier was fed to a triode, with the neon connected between B+ and the triode plate. The high tension supply for this latter stage was taken from the d.c. mains,

# FOR ALL HAM REQUIREMENTS VEALLS HAVE EVERYTHING

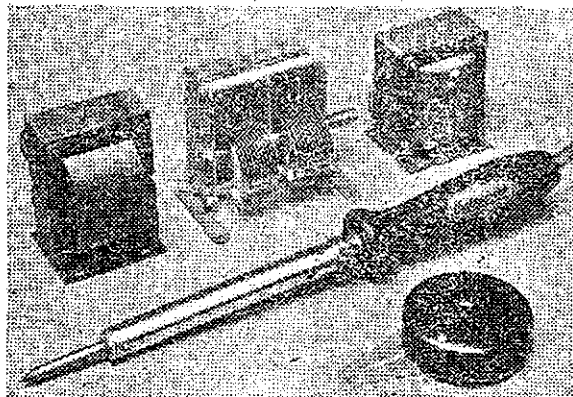

Vealls have it for you at the right price — Everything from knobs to receivers at Swanston Street or, if you're South of the Yarra, keep on the beam by making our Prahran Store your headquarters. — Contact VK3FR (Fred Smith):

**ITEMS ILLUSTRATED:** (Subject to Ham Discount) (Top left and right): **GLADSTONE POWER TRANSFORMERS.** 60 Mill. 275 V., 27/9 each. 40 Mill. 275 V., 26/- each.

(Top Centre): **STROMBERG-CARLSON GANG CONDENSER.** 1, 2 and 3 Gangs available. Priced at 11/9, 17/6 and 21/-.

(Centre): **HEATMONARCH SOLDERING IRON.** The ONLY soldering iron with a built-in thermostat. Fast heating element (120 watts). Heats in less than 2 minutes. Four interchangeable screw-in tips also available. Price 43/6.

(Lower right): **SLOW MOTION VERNIER DRIVE DIAL.** .55 to 1 ratio. Price 26/11. Vealls offer a complete range of modern type dials.

# VEALLS

243 SWANSTON ST., MELB. FJ 3145  
299 CHAPEL ST., PRAHRAN. LA 1605

Mail Orders—Box 2141 T, Melb.

with a 45 volt B battery connected up in series to boost the voltage.

There was approximately a constant voltage drop across the neon of about 180 volts. The plate voltage was therefore equal to the supply voltage less 180 volts.

The only trouble I had with this amplifier was due to it being microphonic, owing to the use of battery valves. The least shock caused a series of parallel lines to appear in the receiver. This trouble was largely overcome by mounting the amplifier on a pile of newspapers.

The low frequency response was ample. In fact three full scanning lines thrown onto the diffusing screen gave enough response to hold the remaining twenty seven lines completely blacked out, if they were prevented from falling on the diffusing screen and photo electric cell.

I was able to get excellent shadow graphs of my hand and other objects of similar size. The definition appeared to be considerably better than what I obtained with the gramophone record as a source of television signal. I expect the results with recorded television would have been much better had I used this amplifier, but this was not tried.

## LANTERN SLIDES

As mentioned previously, I was using the lenses out of a magic lantern. I also had a box of slides, so the next step was to use a lantern slide as the subject for transmission. The handkerchief screen was dis-

carded, and a slide mounted in its place. After bringing the scanning spot to a sharp focus on the slide, I was able to get a picture showing part of the slide.

It was after trying lantern slides that I realised that the 7-by 3 ratio was not the best for the average type of picture. Also, if a cathode ray tube were to be used for receiving, a large part of its screen would be wasted. Desiring a higher definition, a new scanning disc 18" in diameter was made out of a sheet of aluminium. The disc had two separate sets of scanning apertures, 60 in each spiral, making a total of 120 holes.

The first hole of the inner spiral of apertures being displaced half a turn around the disc from the first hole of the outer spiral. The inner spiral of apertures was used for transmission and the outer one for reception. This disc gave a definition of 60 lines, with a nearly square picture having  $60 \times 60 = 3,600$  picture elements, compared with  $70 \times 30 = 2,100$  elements of the old BBC 30 line standard.

Very much sharper pictures were obtained with this scanning disc, although the illumination on the receiving side was a little weak. To improve matter, I placed an Aluminium reflector behind the neon (Osglim) lamp. I also placed a piece of ground glass between the lamp and the scanning disc so as to give an even background. A very thin smear of oil increased the amount of light passed by the ground glass. I also

removed the ballasting resistance from the base of the lamp, as there was sufficient internal resistance in the output valve to keep the current through the lamp to a safe value.

## A SUITABLE STANDARD FOR THE BEGINNER

To anyone who would like to try this, the simplest possible television apparatus, I would recommend that they use a standard of 48 lines, being equal to 2,304 picture elements with a square picture. It is easier to divide a circle into 48, than it is to divide the same circle into 60 divisions. A 48 line picture would also be brighter than a 60 line picture.

With the transmitter and receiver placed on opposite sides of the scanning disc, there will be a displacement of 24 lines between what was transmitted and the picture as received.

Therefore, an extra 24 holes will be needed, making a total of 72 holes to be punched in a spiral of  $1\frac{1}{2}$  turns. The last hole, being nearer the centre of the disc than the first, by an amount equal to  $1\frac{1}{2}$  times the average distance between the holes, measured parallel to the circumference.

As only 48 holes will be used, it will be necessary to mask off the outer 24 holes on the transmitting side. Also the inner 24 holes on the receiving side of the disc.

As very little power is required to drive the disc at a speed of 750 r.p.m. care will be needed if a universal type of motor is used.

It is likewise necessary to elimin-

ate all interference from sparking brushes. A sparking commutator makes a pattern of either black or white spots on the receiver screen. Four, or six stages of amplification, will be needed.

This combined transmitter and receiver should be within the financial and technical resources of most Amateurs.

### CATHODE RAY RECEPTION

The next step was to use a cathode ray tube for reception. The scanning disc being retained for transmission. In all cases where a separate scanner is used for receiving, some form of synchronising is essential. Although the a.c. mains may be used to synchronise mechanical receivers, something better will be needed to synchronise the cathode ray tube.

As there will be two time base circuits, one for the horizontal, and the other for vertical scanning, two separate synchronising signals will be needed, one for each time base circuit.

The line synchronising pulses are best generated by electro-optical means. The same method may be used to generate the frame synchronising pulse; although magnetic or other methods may be used if so desired.

The synchronising pulses may be sent to the receiver through a separate line. However, it is better to mix them with the picture signals, and then separate them at the receiver, according to normal practice.

If the synchronising signal modulates the c.r.t. in the black direction, which is negative, the line and picture frequency flybacks will be suppressed, giving a clearer picture. Also, as the synchronising pulses will be what is called, blacker than black, they will not appear on the screen, so therefore there will be no need to separate the synchronising pulses, from the picture signals which are fed to the grid of the c.r.t. It is, however, essential to remove the picture signal from the synchronising pulses before they are fed to the time base circuits. Some form of limiter may be used for this purpose. Also, the negative synchronising pulses have to be changed to positive pulses before they are able to trip the grids of the 884 tubes in the time base circuits. It is possible to use the limiter valve to change the phase of the synchronising pulses in addition to suppressing the picture signals. The output from the limiter is fed to two filter networks. A high pass filter feeds the line synchronising pulses to the other 884.

Apart from the difference in the value of certain components, the modulation, filter, and time base circuits of Low Definition Apparatus are similar to those used in High Definition gear.

I will now describe some of my own efforts with a cathode ray receiver. Early in 1938 I purchased a 913 1" diameter tube, a couple of

884s, and an extra photo electric cell.

The 913 and 884s were used in a double time base type of oscilloscope, provision being made to modulate the grid of the 913. Power supply was taken from the d.c. mains. I found it necessary to add an extra 150 volts to the h.t. supply as 220 volts d.c. was insufficient. A 6K7 was used as the synchronising phase inverter and picture signal suppressor. The 6K7 had zero bias and a one megohm resistor in series with the grid. This prevented the valve responding to positive signals, although the negative synchronising pulses for the time base were allowed to pass.

In the transmitter, the synchronising pulses were generated by optical means. Each scanning aperture as it passed clear of the mask allowed a spot of light to fall on to a small mirror which reflected the light spot into the synchronising photo cell. This took place at the beginning of each scanning line. The light spot from the scanning aperture in the disc, after moving clear of the small mirror, passed out through the projection lens, scanned the lantern slide or other object, and then into the picture P.E. cell.

The scanning aperture thus produced its own synchronising pulse, thereby allowing for any slight variation in the distance between any two apertures. The synchronising pulse occurred during the first 10% of a scanning line.

For the frame or picture repetition frequency pulse, a long narrow slit, spanning a distance equal to that between three apertures, uncovered the light source, and weakly illuminated the synchronising P.E. cell for a period of three lines, once in every revolution of the scanning disc.

The synchronising P.E. cell has to be suitably phased to the picture P.E. cell by feeding the output from it to the amplifier, an odd number of stages after the picture P.E. cell.

I had apparatus of this type working in November, 1938. Using lantern slides for transmission, I was able to get steady pictures, bright enough to photograph on the screen of the 913. The method of synchronising which I have described is both simple and effective.

Although I used a 913, I think that the 2" 902 would be a better tube to start with. The screen is larger and the operating voltages are much the same as for a 913. There is also very little difference in the price.

### MIRROR DRUM TRANSMITTER

With a mirror drum in the transmitter it is possible to televise with a definition of 60 lines or more ahead and shoulders view of yourself or a friend, by means of direct pickup.

With a mirror drum, the constructional work is much more difficult. Considerable thought must likewise be given to the optical system. For when using either film or slides all the light which passes through the film can be utilised, but in the case

of the televising of opaque subjects only a fraction of the reflected light can be picked up by the photo cells. The amplifiers will therefore have to be run at maximum possible sensitivity. Both the photo cells and the early stages of the amplifier need very thorough screening. Any a.c. fields which may leak through the screening can completely spoil the picture. R.F. can be particularly troublesome, as a video amplifier has to cover the range from audio to radio frequencies.

I found that one of my amplifiers was particularly sensitive to the r.f. coming from 6TZ (frequency 1,340 Kcs), which is 20 miles from Harvey.

I have listened to 6TZ for hours on a resistance capacity amplifier with only 4 inches of aerial, one stage of the amplifier was used as a detector. I was using battery power supply at the time, so I can truthfully say that the only inductances in the set were the loudspeaker windings.

Owing to these and other difficulties, it took me about four years before I was able to televise people by means of direct pickup.

### HOW IT WAS DONE

A mirror drum with 24 mirrors was used for horizontal scanning. Vertical scanning was done by means of an oscillating mirror. A cam tilted the oscillating mirror once for every 2½ turns of the mirror drum. I therefore had a standard of 2½ x 24 = 60 lines. The cam operating the oscillating mirror was driven at 800 r.p.m., giving a picture repetition rate of 13½ frames per second, which was fast enough to eliminate flicker with the type of c.r.t. I was using. The mirror drum, which was eight inches in diameter and mounted between two ball races, was driven at a speed of 2,000 r.p.m.

Both the mirror drum and the oscillating mirror cam were belt driven from a series type of electric fan motor. Please note the belt drive. Machine cut gears, as were frequently specified, were found to be unnecessary. With electro-optical generation of the synchronising signal, the image on the c.r.t. screen remains perfectly steady, even though there may be considerable changes in the speed of the mirror drum. An induction motor would have been much better, but I did not have one.

The light from the exploring scanning spot, after being reflected by the subject, my face for instance, nothing better looking being available, was collected by two P.E. cells, housed on either side of the transmitter. The output from these P.E. cells was amplified by a three stage r.c. amplifier, mixed with the synchronising signals, line and frame, and then further amplified in another three stage r.c. amplifier.

The output from these amplifiers was then fed through a short transmission line to the receiver. I never attempted to measure the frequency range of the video signal output of

this amplifier but from a careful inspection of the televised test pattern I estimate that the output should include frequencies between about 15 cycles per second and 25 Kcs.

The video output from these two amplifiers, six stages in all, was used to modulate the grid, and hence the brilliance of the scanning lines on the screen of the cathode ray tube.

I later replaced the 913 1" tube with a Philips DG71-G 3" tube. This gave a larger and brighter picture.

Negative synchronising was retained, a limiter being used to remove the video signal from the synchronising pulses which were further amplified before being fed to the 884 grids, in time bases. A total of 17 tubes were used, comprising three photo cells, two 884 gas triodes, one cathode ray tube, ten r.f. pentodes, and one rectifier.

About this time I obtained a rotary converter. It was now possible for me to use an a.c. power supply for the amplifier, c.r.t. and time bases. High tension for the c.r.t. and time base circuits was obtained from a pair of H.T.9 metal rectifiers, in a voltage doubler circuit, giving 800 volts d.c. on load.

The picture on the 3" tube was about 1½" square. The scanning lines were hardly noticeable at a distance of a little over 2' from the c.r.t. screen. The picture was both bright and steady enough to photograph. A time exposure of less than half a minute at F16 was sufficient.

The receiver was placed on a shelf, a little to one side of the transmitter so as to enable me to see a head and shoulders view of myself in the receiver, whenever I stood within range of the transmitter.

Some means of self televising, such as this was essential, as it didn't take very long for the other members of the family to get tired of posing for me!

When using the flying spot method of transmission, the subject is in semi-darkness, hence I had no difficulty in seeing my own likeness on the c.r.t. screen, if I turned my head sideways.

Although direct pickup work is very interesting and considerable fun can be had by inviting your friends to see what they look like when they are televised, I would recommend the beginner to start with the Niphov Disc and lantern slides, as a small machine shop is almost essential for the construction of a high speed mirror drum.

Such were my efforts up to the end of 1942. With the war over and some hope now of getting parts, I have returned to television experiments.

During the past 18 months I have been doing a lot of constructional work on a Telecine Transmitter using cinematograph film as subject matter for transmission. I expect to have this transmitter in operation before the end of 1947. Most of the remaining work which has to be done is in connection with the optical system.

The projector and sound head were built last year. The amplifiers are now useable, while the c.r.o. and time bases, used in 1942, are to be rebuilt. The motor which I built for driving the scanner can only handle a 7½" diameter disc, so I expect that I will have to build a more powerful motor.

After dealing with the inevitable gremlins, I hope to raise the definition up to about 90 lines or so; By incorporating voltage regulated power supplies, I should sidetrack quite a few of the feedback problems from which I suffered in the past.

I hope that it will not be very long now before we Amateurs can purchase electronic pickup tubes. This would enable us to get much better definition than is possible with the best of mirror drums or scanning discs.

At this stage I would like to thank "Amateur Radio" for the opportunity of narrating to you my experiments and experiences. While writing this article I have re-lived many moments of pleasure, of doubts and of difficulties and disappointments.

Being domiciled in the country has prevented me from contacting fellow Hams. However should any of you be in Harvey, I would only be too pleased to meet you and, if not otherwise engaged, would enjoy a ragchew and if you so desire show you over the shack.

**"ALL-ROUND" EFFICIENCY**

**TRIMAX TRANSFORMERS**

Available in Line to Line, Line to Grid, Plate to Line, Interstage—Single and Push-Pull Types—Trimax Transformers are constructed of the finest materials and feature high Permeability, Nickel Iron Alloy core—heat treated in our own factory for optimum results. Also for Amplifier enthusiasts... Standard or Custom built Chassis, Speaker Flores, Microphone Stands, Power Transformers, Filter Chokes, etc.

**TRIMAX TRANSFORMERS**  
(Division of Cliff & Bunting Pty. Ltd.)

**29-35 FLEMINGTON RD., NORTH MELBOURNE**

Interstate  
Representatives:

N.S.W.:  
L. B. Graham,  
5 North York St.,  
SYDNEY

QUEENSLAND:  
Chandlers Pty. Ltd.  
Cnr. Albert and  
Charlotte Sts.,  
BRISBANE

S.A.:  
C. N. Muller  
Warando Buildings,  
Grenfell Street,  
ADELAIDE

W.A.:  
R. D. Benjamin,  
197 Murray Street,  
PERTH

TASMANIA:  
W. & G. Genders  
Pty. Ltd.  
53 Cameron Street,  
LAUNCESTON

ENQUIRE FROM YOUR NEAREST SUPPLIER



PHILIPS

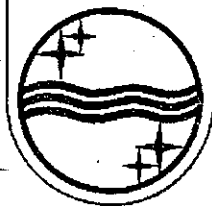

Calibration immediately pin-pointed

Replaceable Indicator Scale. Five ranges

Available NOW!

# PHILIPS LOG DIAL

for easy, accurate, individual calibration

Specially designed for transmitting radio amateurs, short-wave listeners and equipment engineers, the new Philips "Log-Dial" is the ideal control and indicator mechanism for VFO (Variable Frequency Oscillator) Transmitter application, Amateur Band HF Receiver bandspreading, VHF Receiver tuning, Frequency Meters, Monitors and for many other radio and electrical applications. The Philips "Log-Dial" mechanism provides positive, smooth running with no slip or backlash. It has an ample reduction ratio

for quick or slow tuning; calibration cannot be affected by mechanical troubles. The off-set Cursor provides instant logging without the need for scale reference or movement. The two-colour scale is removable, two are included with each "Log-Dial", and further replacements are available. It may be mounted on front of or behind instrument panel. The Philips "Log-Dial" is designed for  $\frac{3}{8}$  inch shaft drive but is adaptable to larger sizes. It is finished in attractive Florentine Bronze.

25/-

● The "Log-Dial" is available now from your nearest Philips branch; the price is only 25/- with special reduction for licensed amateur radio transmitters.



PHILIPS ELECTRICAL INDUSTRIES OF AUSTRALIA PTY. LTD.

Sydney • Melbourne • Adelaide • Perth • Brisbane

G23

# FEDERAL NOTES

At the 17th Annual Convention held in Melbourne last Easter, the Federal Executive was directed to approach the International Amateur Radio Union with respect to the desirability of sub-dividing the high frequency amateur bands into phone and c.w. (Motion 29a) and request that prior notification of all world contests so that amateurs will be familiar with operational procedure before the contest starts (Motion 43). A reply from the Assistant Secretary I.A.R.U. is to hand and is as follows:

"Commenting upon your Motion 29a, as requested, we are obliged to say we feel certain that very little, if any, practical results could be obtained from an effort to sub-divide the high frequency amateur bands on an international basis as between phone and c.w. The principal reason is that such an effort has been made several times in the past, without making the slightest progress. For example, A.R.R.L. representatives at the recent inter-American conventions have tried to effect such an agreement on the part of the various American countries, as a starter; but it turned out that there was no hope for such a plan, the principal difficulty in this case being that most of the South American nations are predominantly phone, and the amateur operating philosophies as between Canada and the United States on the one hand, and the rest of the Americas on the other, are simply too far apart.

"As a further complication of any effort which might be made now, it is probable that as a result of the Atlantic City conference now being held there will be a marked difference in overall band limits between various regions of the world.

"I think your Motion 43 is a good one, and we shall certainly include mention in the December Calendar of the desirability of giving advance publicity to international amateur contests. While I believe that it is true that post-war confusion has prevented the carrying out of good intentions, it certainly will do no harm to point out the thought."

## NEW PUBLICATION

The Federal Executive is about to prepare a companion publication to the Postmaster General's Department Handbook. This publication will contain:—

- (a) Guiding principles for the efficient operation of amateur stations.
- (b) Standards of station design and installation covering basic principles, fire insurance requirements, safety standards, etc.
- (c) Reasons why all amateurs should be members of the Wireless Institute of Australia.

As you all will agree the compilation of such a comprehensive publication entails considerable thought and effort by Federal Executive. Suggestions and comments on the material which you think should be included under the above headings are urgently required. Please send your ideas to the Federal Secretary, Bcx 2611W, G.P.O., Melbourne. Give us your comments NOW, not when the booklet is published.

## INTERSTATE CONTESTS

Motion 41 of the last Convention directed that Federal Executive arrange Interstate Contests on all bands annually to perpetuate the names of amateurs who lost their lives in the service of the country during the war of 1939-45 and that the trophies awarded carry the names of all such amateurs in accordance with Item 11 of the 1946 Convention.

In order that the list of names of those amateurs who paid the supreme sacrifice may be as full as possible we seek your earnest co-operation in furnishing any information in this connection to either your Divisional Secretary or the Federal Secretary.

In the July issue of "Amateur Radio" suggestions as to a suitable name for such an annual Interstate Contest were requested. To date no suggestions have been submitted, therefore Federal Executive has tentatively named the contest "The Remembrance Day Contest" which has been provisionally decided to take place during the week-end of 14th-15th August, 1948. The third

anniversary of the fall of Japan and the end of the war.

Whilst on the subject of contests, it has been decided to hold the following contests in addition to the VK International Contest:—

National Field Day—week-end  
January 24, 25 and 26, 1948.

Trans-Tasman—week-end May  
15 and 16, 1948.

Details of the latter contest are now under consideration by the Contest Manager from whom we shall hear more on the subject in the near future.

## ITEMS OF INTEREST

The Official Station of the Federal Council of the Wireless Institute of Australia is VK3WIA. It is anticipated that this station will be on the air in a few weeks time, so keep a lookout on the 7 Mc. band for the first broadcast.

The successful design for the W.A.S. 50 Mc. and Above Certificate was submitted by Malcolm McCartney, VK3KV.

New appointment: Sub-Editor of "Amateur Radio," Ron Hugo VK6KW.

Supplies of membership badges have been forwarded to all Divisions and enquiries should be directed to your Divisional Secretary.

Arrangements have been finalised with the Postmaster General's Department for regular lists of cancellations, alterations and new licences issued. This information will be supplied to the Federal Executive and will be communicated to the Divisions and if possible through this column.

# GLO-RAD

**CUSTOM BUILT EQUIPMENT**

**CAREFULLY ENGINEERED TO MEET**

**YOUR INDIVIDUAL REQUIREMENTS**

"GLORAD" is now in a position to cater for  
**YOUR requirements, large or small.**

Send sketches and full details to:—

**GLORAD ENGINEERING SERVICES**

**186A Riversdale Rd., (Cr. Robinson Rd.)**

**HAWTHORN ————— VICTORIA**

**Phones: Day—WA 3819. Night—WX 3440**

# SUCH NICE PEOPLE

By "GREMLIN."

Most times these days I just sit and listen. Reckon I know a lot of blokes much better than when I just swapped RSTs. Spiders are building around the old key and the rig is Amateur Radio, to say nothing of increasing the store of knowledge. One thing I have learned, VK is not inundated with poor signals and punk operating. Thanks gang! ——— Heard on 7 Mc.: "3RN do 2DO—give my regards to 'Gremlin'." "2DO de 3RN—do you like him or don't you?" Thanks OM, herewith my "R," and trust it saves 3RN some worries as to delivery. Yep, you can take it. Nice spot Yass, know it well—is that any help? ——— My apologies to the Type 3 Mk. 2. I gather a few blokes have removed the click filter for cathode modulation, hence my remarks last month. ——— Just when my coloured beads were getting all bunged up with fluff, up pops my old cobber Alf, 3VJ, 30 CQs, 8 signs, followed by 13 CQs and 4 signs!

Having any difficulty listening to the Sunday broadcasts of 2WI, 3WI and 5WI? Chaps who aren't interested could easily think of others and at least keep the channel clear during the broadcasts. Judging by the remarks addressed to the Divisional Stations, I'm not the only one with a grudge.

Methinks I whipped a bit of J and H business awhile back—you know, piratical stuff. 2100 hours 2/8/47 heard 3OZ with a very rough note and at 1000 10/8/47, 3FO very chirpy. Neither signals anything like the usual from you chaps. May have been dinkum but I have my doubts, for I heard you both a couple of days later with the usual signal. ——— 3TS, your phone splashes badly on the low frequency side. Don't know what you are using but I've noticed screen modulated signals sometimes splash badly on one side. Those screen modulating an 813 may be well paid to have a looksee. Take a peep at the screen current first. Sweet, isn't it? Next consult somebody who knows—I don't. ——— 5AV's c.w. is pretty chirpy. I believe you are up Darwin way and I can't really blame anything feeling a little elated in departing that clime. ——— 5QV and 3IS also chirpy, plus 3AIR adding thumps for good measure.

Clicking along—2EO, 2AIB, 3AH, 3ADH, 3UN and—this is beginning to hurt—3RW's abrasive job. You win Reg, I've had it. Not another mention until I hear you T9X. That's a promise so PLEASE put me out of my misery. ——— 5CW is another with a rough note. ——— "Even his best friend" gang—7MY, 3GK and 2EU. The latter plus splash. Nothing

# FEDERAL QSL BUREAU

RAY JONES, VK3RJ, MANAGER

Apropos of last month's par pre-war QSLs now coming to hand, among a further batch just received is one from PA0UN relating to a contact with VK3OC on 14 Mc. on 13th September, 1936! In those days VK3OC was a power in the DX land. Maybe the receipt of this card will provide Ray with the necessary inspiration to restore his call sign and station to its pre-war glory.

A card to the QSL Manager from CR7VAL bears the following superscription "I receive your orders in Mozambique." Can anyone offer an interpretation? From observations the QSL Manager formed the opinion that his "orders" were not even "received" in his own menage.

A listener report to hand from Germany states in, excellent English, that the sender was a P.O.W. in Australia at Murchison, Victoria, for over five years. He solicits receipt of any spare literature about radio as "it is the only thing that really interests me." QTH is Hans Linke, Tischbeinstrasse 10, (24) Hamburg 33, British Zone, Germany. Can anyone help out please?

A sticker from Sweden announces that their Field Day Station SM3XA was set up at Ostersund, 1,400 feet above sea level in one of Sweden's choicest countryside spots, from 25th to 31st July. Goes on to say "If you care for a QSO with the famous Monster of the Great Lake in Jamtland, Sweden, call SM3XA. A sketch of the "Monster" depicts three half waves showing above the surface of the Great Lake.

The new address of the Italian QSL Bureau is ARI-QSL Bureau, via S. Paolo, 10-Milano (Italy).

In a movement to regroup its services the R.E.F. have again changed the address of its QSL Bureau. The new address is Service QSL, 6 Rue du Pont de Lodi 6, Paris VI, France.

A change in the Bureau address for Fiji is also to hand. The new QSL Manager is VS2AS whose address is Mr. S. H. Mayne, Victoria Parade, Suva, Fiji. Licences in VR2 as at

personal mind you, just a little more care with the signal wanted. Now would that be considered diplomatic? Goody goody! ——— 4EJ and 2TE splash. 3ABJ just distorts. ——— 2AZ heavy background music 1940/18. ——— By the way 3TO, have heard you a few times and no sign of that parasitic. All's well. ——— And so into a new era when f.m. is cricket—on some bands (is that any better Editor?). Won't tell you what I said last month, must have been naughty for honourable gent cut it out. Cheers.

14th July, 1947, are VR2AG, 2AJ, 2AK, 2AL, 2AM, 2AO, 2AP, 2AQ, 2AR, 2AS, 2AT, 2AU and 2UH. Most of the stations are situate either with the R.N.Z.A.F. at Laucala Bay, or with Aeradio at Nadi Airport. The retiring QSL Manager VR2UH/ZL2UH, D. A. Leslie, has returned to his ZL address for a spell.

The Federal Secretary of the W.I.A. has requested publicity in these notes for the following motion (General Business No. 11) of the 1947 Federal Convention: "That it be a recommendation that all QSL cards be of standard postcard size and that the call of the addressee be written prominently on the back." It should be self-evident that failure to comply, results in damage to outsize cards and to delay in handling.

Glad to hear from Russ (VK3XK) once again. Russ, who does servicing at lighthouses, expects to be at Cape Wickham King Island for a couple of weeks during September-October. Will probably take along the Type 3 Mark 2 which he used with success while at Cape Schanck, Victoria, recently. Whilst at the latter lighthouse Russ renewed his acquaintance with 3.5 Mc. and found it a pleasant change from his DX activities of 14 and 28 Mc. from his home address. Russ received one card at Cape Schanck addressed VK3XK, Port Able, Cape Schanck, the sender having preserved the nautical atmosphere in the address. Russ further mentions that he needs verifications from only six American States to qualify for W.A.S. Don't want to discourage you Russ but writer has needed the same number since 1939. Suggest you contact Alan Brown (VK3CX), he found the knack of wringing out a card from the rarer States. Ask him how he finally got Delaware.

The Victorian QSL Manager, Graham Roper, VK3ZB, 26 Lucas Street, Caulfield, S.E.8, Victoria, again sends out an SOS for Victorian metropolitan stations to collect their cards. Graham says his sofa is only 5 feet long and cannot accommodate many more cards. Do the right thing chaps and help him to help you. QSL activity has reached an all time high and cards for VK stations are being handed at the Federal Bureau at the rate of 8,000 monthly. Each month sees the record being broken. Where will it all end?

The writer has made arrangements for VK9GW (ex-VK3ABW) to act as QSL Manager for VK9. His address is Mr. G. A. Warner, care O.T.C., Port Moresby.

## KEEP YOUR BALANCE

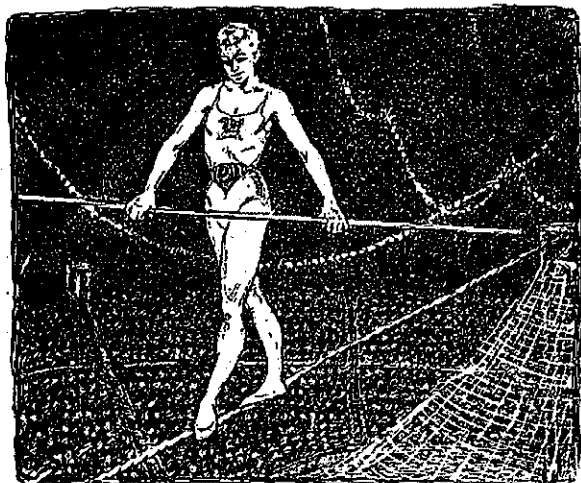

A skilful tight-rope performer was asked how he managed to succeed in his career. He replied: "I take one step at a time and keep my balance."

To keep one's balance at the present time is sound advice, especially one's Savings Bank balance, for with the partial lifting of wartime controls there comes the temptation to spend carelessly on fads, fancies, and luxuries.

Don't buy on the impulse unnecessary articles that attract you: keep your balance.

*Think carefully before you spend*

# THE STATE SAVINGS BANK OF VICTORIA

"SAVE AT THIS BANK"

## FIFTY AND UP

The old 50 Mc. band lived up to its reputation again by opening on the following dates and times.

Sunday, 27/7/47, 1330-1830.—Queensland to Victoria contacts were remarkably stable during the whole session. Stations making contacts included VK4ES, 4HR, 4RY, 4AW, 4TR, 4ZU, 4RT, 4KB, and 4CT in Brisbane, and 4SN, 4BJ, 4PG, and 4CU in th country. Victorian stations were 3HT (worked 13), 3BD (worked 7), 3EH, 3BW, 3CP, 3YP, 3YS, 3GG, and 3BQ.

On the very same day at 1900-1915 hours the band opened for first time since last year for contacts between VK2 and VK5 when VK5QR heard VK2OC calling "CQ Six" at 1850 hours, S9 with no QSB. He was unable to call as the 50 Mc. rig was tuned on 7 Mc. (3YS note!). A hurried retuning and a CQ DX call brought no response, but VK5CU heard the call and tuning the band heard VK2Y? (surely not VK2YC—Editor) calling CQ. VK5CU's CQ DX netted VK2FO who came back twice but unfortunately faded as he was about to give the signal report. Congratulations on the contact Cliff. Several VK2 stations were heard calling VK5CU, all at excellent strength.

VK5QR heard and called VK2NP R5 S8; VK2OC R5 S9, VK2WJ R5

S9, and also heard a VK2 calling on m.c.w. near 52 Mc. No contact was made however! It appears that the rig was running self-excited most of the time, due to the frenzied QSY from 7 Mc.

VK5GF made a belated appearance but the fade out had started. Max had been working on 28 Mc. and noticed the extremely short skip (VK2-VK3) and listened on 50 Mc. until 1815 hours but heard nothing.

VK7XL heard VK4CU, 4TR, and 4ZU calling and working VK3s at around 1730. Signals were fading S9 to S1, and 7XL called them to no avail. His converter uses 9003 r.f., 9003 mixer and 9002 oscillator in conjunction with a three element beam.

On Saturday, 2/8/47, VK3HT and 3KX worked 4KR and 4ZU in the afternoon. VK3ZL had a part QSO.

Sunday, 3/8/47 at 1500 hours, VK5GL heard 4PG working 3HX (VK3HX, being Editor of this Magazine, begs to be excused the honor as he has not yet made an appearance on this band—Editor) S4 on peaks, and same day, 1947 hours 5CU heard 3HZ S6 calling 5GL.

## NEW SOUTH WALES

N.S.W. V.H.F. Section is now well under way after four successful meetings with an average attendance of about 45. The 50 Mc. boys are looking forward to the expected DX.

Some multi-element horizontal beams are under construction, but the general idea here seems to be to use vertical for cross town rag-chewing.

## VICTORIA

VK3ZL, at Ballarat, provides some interesting reports of Melbourne stations. 3EH gets through the best. 3IG, with a plain horizontal dipole 50 feet high, gets through better than 3HK, 3HT, 3YS, etc., with their four element beams 25 feet high. 3HZ, at Warrigul hears 3ZL but no contact so far. 3GM at Ballarat gets through occasionally. Pleased to hear that ex-3IZ from Red Cliffs will be on soon. 3ZL hears 3KZ (Didn't know the BC stations were on 50 Mc.—Ed.). New stations 3IG, 3KX, 3AMP.

3BQ and 3GM, down from Ballarat, conducted some Rx tests using a portable low power oscillator placed some distance from Rx aerial. From the results, 3GM thinks Melbourne receivers are better than Ballarat's. VK3BD has f.m. receiver OK and his transmitter almost ready for f.m. also.

## QUEENSLAND

The 50 Mc. fraternity in Brisbane recently had the pleasure of a visit from 3MJ and we were all interested to hear Dave's account of doings down under and his views and experiences with horizontally polarised beams, and the great improvements noticed, particularly in reception.

## WESTERN AUSTRALIA

The usual gang still active from home stations but the week-end weather lately has been too unpleasant for portable work. 6SA and 6LW both waiting to try the Northam Rottnest route.

No new signals yet on the band but several of the country boys are very busy building. Hope to hear very soon from Geraldton and Albany that they are ready for tests.

Very successful tests have already been carried out with f.m. on this band using reactance modulations of an e.c.o. Earlier tests with xtal, although f.b. on 27 Mc. did not work out on this band owing to the poorer selectivity of the higher i.f. channels used in the 50 Mc. receivers. Up to the time of writing the f.m. transmissions have been carried out by 6LW with 6FC, 6GB and 6SA using detuned a.m. receivers, but several of the boys expect to have ratio-detectors ready soon.

## TASMANIA

7XL and 7AB have a reliable circuit between Devonport and Burnie on 50 Mc. now. 7LZ and 7BQ in Launceston, are preparing for a flutter in the near future.

## 166 Mc. ACTIVITIES IN VK

Approximately 20 stations are now active on 166 Mc. in Sydney. The majority are using superhet receivers. At least three stations are using xtal control. 2KI recently went portable to Bowral and was able to have several successful contacts with 2FK over 60 miles. 2AGL has been active with a "Handy Talkie" as well as the main rig on 166 Mc. In co-operation with 2AHG and 2PW he was able to demonstrate to the last V.H.F. meeting that the little job really works! Best DX to date is 10 miles.

Those active in VK3 are 3ACM, 3RR, 3EM, 3MB, 3MN, 3LS, 3MD, 3ARK, 3NB and 3KR will be on soon. Not many beams in use, only 3MB and 3ACM using them. Vertical dipoles and ground planes for the rest. 3NB is using a non-radiating super regen (cheers). Unintentional f.m. (via mod. osc.) is used extensively. 3WQ has nice 166 Rx and almost ready, it has 2 r.f. stages, mixer, and osc. all acorns, and six i.f. (1852) on 30 Mc. Very neat.

The efforts of 4FB and 4XG some months ago on 166 Mc. have at last yielded results, and it seems as though the band is about to receive additional occupants. 4TR and 4HR have been active and 4KB, 4ES, 4ZU and others are on the way up.

VK5GB makes a good job of re-transmitting W.I.A. news on V.H.F., both 50 and 166 Mc. But don't be a piker, Geo., give the "ergs" a chance, push your V.H.F. antennae to the top of the stick. — — — 5KZ indulges in "pirate-like" practices. Hides his antenna behind the garden fence. Doesn't cover as much territory as of yore. — — — 5RQ is a staunch club member, but his signals are not

## CORRESPONDENCE

Shepparton

The Editor, "A.R."

The decision to cancel the probationary period on c.w. will, we are sure, be regretted by all Amateurs who are interested in brass pounding, and especially the old-timers who were brought up on the belief that a Ham wasn't a Ham until he was a proficient c.w. operator, even though it was often a long and painful process. There is the undeniable fact that in times of emergency an efficient c.w. operator may be the means of saving life or providing communication where it is either impossible or undesirable to use telephony. The recent war and the work done by the R.A.A.F. Wireless Reserve members, especially in the early stages, is one instance. Going further back many will remember the traffic handled by Hams between Hobart and Melbourne for the P.M.G.'s Department during the 1929 Tasmanian floods. And there are other cases too.

We feel that the Institute should take a more active part in encouraging the use of c.w., as there is an increasing tendency among new licencees to take the line of least

so robust. How's about it Claude? JD would like to QSO. He's still after that "W.A.S." — — — 5NG still a keen mobile man. Believed to have something good on the bench. We'll be listening out! — — — 5GL got away to a nice start but faltered at the furlong post. Building a superhet. — — — 5RT likes wet weather, improves the impedance matching round the shack! — — — 5QR, congrats are the order of the day. Winner of the I.R.E. award. Still, what about getting off those laurels and making yourself heard on 166 Mc. 5RV works on the principle that low angle radiation is best obtained with the antenna half wave above an effective earth. Also believes in short transmission lines. The transmitter nests in the eaves! — — — 5JD QRL with various antennae. Latest addition being a GPA. 5JD has an 815 going well. — — — 5GF is also on this band.

VK6LW still waiting for somebody to join him—hearing his own signal over a distance of a mile does not afford him much pleasure.

Activities in VK7 on this band are unknown. If anyone is active please drop a few lines and let the gang know what is happening.

## 1300 MEGACYCLES

In New South Wales VK2NP is experimenting with broad band dipoles for 1300 Mc. How about sending along some more dope, OM?

VK3VM (Ted Marks) is using a cavity resonator and a 2C40 (?). Ted is a surgeon dentist so we can understand why he uses a CAVITY resonator. Some more dope from you would be appreciated also Ted.

resistance and go straight on phone, which means the loss of another potential c.w. operator. At that early stage constant practice is the only way to improve, and once it is neglected it is seldom one feels like starting all over again. To this end the Institute could well take a lesson from the A.R.R.L. who are always out to encourage the use of c.w., with code practice transmissions, official bulletins sent in c.w., etc. The A.R.R.L. HQ station operating times daily are 4½ hours c.w. and 1½ hours phone, whereas we have never heard of our official station being on anything but phone. And we would suggest that consideration be given to the revival of the "Five Point" Relay Contests, which were at least more a test of an operator's ability than present day contests.

And, if it is not compulsory for a station to come on the air on c.w. now, what is the point in having to pass a code test as part of the examination? Can it be that the Department realise that a man who knows the code may be of some practical use some day—if he sticks to it?

Yours, etc.,

C. HARRISSON, VK3CN.  
A. H. BUCK, VK3TM.

[VK3WI has conducted code practice transmissions. Federal Executive advise that the abolition of the regulation referred to was secured by the Institute in pursuance of its policy of reducing restrictive regulations to a minimum. Means of encouraging a greater use of c.w. is being examined by Federal Executive at the present time—Editor.]

## INSTITUTE BLOCKS

The Council of the Victorian Division of the W.I.A. has procured blocks of the Institute badge for use by its members on their stationery.



Two sizes as shown herewith are available free of charge upon application to the Secretary. Country members are requested to send their enquiries to Box 2611W, G.P.O., Melbourne.

## ISLE OF MAN—GD

As a result of representations made to the G.P.O. by the R.S.G.B. on behalf of radio amateurs resident in the Isle of Man, the separate prefix GD has been allocated to all Isle of Man amateur stations who are no longer authorised to use G.

Isle of Man will henceforth be regarded as a separate Dominion Zone for B.E.R.T.A. and the new Empire DX Certificate. The A.R.R.L. have also agreed to its recognition as a separate country for DX C.C.

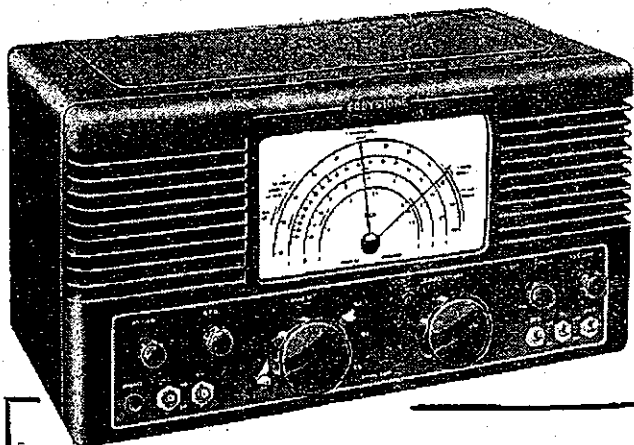

*This is it!*  
the "640"

**ALREADY ACCLAIMED IN ENGLAND AS THE FINEST 'HAM' SET YET DESIGNED**

**● READ THESE TRIBUTES ... FROM THE "G's" OVERSEAS**

**EDDYSTONE  
AMATEUR BANDS COMMUNICATIONS  
RECEIVER MODEL 640**

**MAIN TECHNICAL FEATURES**

1. Receiver has been designed primarily for Amateur Communication purposes, tuning range from 31 Mc/s to 1.7 Mc/s.
2. Designed to operate from Standard AC Mains with Inputs of 110 volts 200/240 volts, 40/60 cycles as well as from a 6 volt battery by the use of a separate vibrator unit.
3. Inclusive all valves, the "640" is a 9-valve job with one tuned RF stage, FC, two IF stages, detector-AVC-1st audio, 2nd audio output, noise limiter, BFO and rectifier. The valves used, in that order are EF39, 6K8, EF39, EF39, 6Q7, 6V6, EB34, EF39, and 6X5. These are all international octal based on the Mullard or Brimar versions and are therefore easily replaceable.
4. INPUT IMPEDANCE—400 ohms.
5. TUNING RANGE—
  - (1) 31 to 12.5 Mc/s.
  - (2) 12.5 to 5 Mc/s.
  - (3) 5 to 1.7 Mc/s.
6. TUNING. An electrical band-spread arrangement is used for this purpose. Fly-wheel control is utilised on the band-spread condenser drive. The scale is clearly marked with all amateur bands, and is so arranged to enable accurate re-setting to a spot frequency.
7. I.F. FREQUENCY—1600 Kc/s.
8. CRYSTAL FILTER is vacuum mounted to provide a high degree of stability. Phasing control and "in/out" switch are brought out to the front panel.
9. Sensitivity is better than 2 microvolts input, for 50 milliwatts output, at all frequencies.
10. OUTPUT. Audio frequency output exceeds 3.5 watts.
11. "S" METER. A socket is provided for an external "S" Meter.

● "Your claims are fully justified, the performance being excellent in every way. The outstanding feature is of course the Wonderful signal to noise ratio, and this, together with its excellent sensitivity, should satisfy the most confirmed critic.

On the 10 metre band I have compared received signals using the "640" and a 3 element beam, with the same received signal at other stations using 3 element beams, time and time again (hence the delay in sending my report), and I have proved to my satisfaction that the "640" has the advantage, taking an average over a large number of contacts, which practical report you will probably appreciate more than most laboratory reports. The excellent signal to noise ratio of the "640" has enabled me to carry through a QSO which, with my previous Station receiver, would not have been completed, under similar conditions. I have spent quite a lot of time on these comparative checks, and have proved these points conclusively.

The noise limiter is extremely effective, as is the crystal filter. In conclusion, I state that the "640" is a really fine job, which fills a long felt want for a standard British Amateur Communications Receiver, which will have my hearty support, and I hope that this is the first of a new series of Amateur Instruments by Eddystone.

I might add that the "640" is now my own station receiver, and I'm rather fussy."

● "It proves it to be a most remarkable receiver and you are to be congratulated on producing such an outstanding 'Ham' set, and we wish you every success in this market."

● "Having fully tested the model "640", it fully comes up to the standards required for a Communications receiver of this nature, especially on the 'Ham' bands we were able to separate stations working almost on top of each other.

The signal to noise ratio is extremely good. We have great hopes for this set during the coming season. You are to be warmly congratulated on the production of a very fine model."

● "The "640" was tried out over the week-end by our Mr. W. and J. B., an ex-Merchant Navy Radio Officer of some ten years operational experience. The latter was delighted with the sharp and clear C.W. note obtained by this receiver. We compared general sensitivity, selectivity and ease of control with two highly rated USA RX. "640" compared more than favourably with either model. Noise level for a given signal in fact was much lower in either case and the measured carriers of very weak signals were in several instances slightly superior on the "640." The appearance is really a fine job and altogether we feel that if this set was exported even to the USA it would readily find enthusiasts who still believe we in Britain can produce the goods without a lot of unnecessary trimmings and yet efficient and exacting standards."

These are extracts from just a few of the numerous congratulatory letters received by the makers of the "640."

**THIS FINE SET IS ON THE WAY . . . BUT SUPPLIES WILL BE LIMITED SO . . . PLACE YOUR ORDER NOW WITH YOUR AUTHORISED DISTRIBUTOR**

Australian Factory Representatives:  
**KEITH HARRIS & CO. PTY. LTD. 51 William St., Melb. . . . Phone MB 2119**

## DIVISIONAL NOTES

### NEW SOUTH WALES

Secretary: Peter H. Adams, VK2JX  
Box-1734 G.P.O., Sydney.

Meeting Place: Science House, Gloucester and Essex Streets.

Meeting Night: Fourth Friday of each month.

The last meeting of the N.S.W. Division was held at Science House on Friday, 22nd August, and the attendance was, as usual, quite large.

Following the general business, the evening was devoted to the holding of a "Quiz," which proved very popular and some very knotting problems were thrown into the ring for solution. The opinion of members present seemed to be that more of this sort of thing would be welcomed.

The Division held its 7th Annual Dinner on the 7th August and quite a large roll up of members attended. Mr. Armstrong was present to represent the P.M.G.'s Department, and representatives of the various Radio Clubs in the metropolitan area attended. It was most gratifying to see some of the boys from the country districts present and everyone voted the evening a success. The number of personal QSOs which were held during and after the dinner proved that the average Ham can talk just as well without the aid of a key or microphone, as with one.

The positions of Zone Officer for the South Coast and Newcastle Zones have been accepted by VK2ANN and VK2FP respectively.

An interim or progress report submitted to the last Council meeting indicates that the A.O.C.P. classes being run by this Division are proving very popular and assisting to swell the ranks in this State.

Permission has now been granted to make use of the 50 Mc. band for W.I.A. weekly broadcasts and these will take place until further notice on Sunday evenings, thus supplementing the transmissions on 7 Mc.

Membership of the Division is increasing at the rate of approximately 8 or 10 per month and usually the attendance at general meetings takes the capacity of the hall.

There is not much personal gossip this time chaps, but unless you let us have it we can't write it, so how about a ring or a note sometimes. Don't forget that the competition for the best technical article for the "Mag" is still running.

### NEWCASTLE AND DISTRICT ZONE

2BZ very pleased with results on 14 and 28 Mc., using twin beams on top of 36 foot telephone pole. — 2AHA working Europe on 14 Mc., sometimes on 28 Mc. Over 100 countries up. — 2PQ, a newcomer on phone, operates on 28, 14, 7 Mc. Gets good reports from U.S., Burma, etc. — 2AFS getting out in all directions with a two ele-

ment beam; over 36 countries with only 36 watts. — 2AE heard tuning up with an 813. Has some feedback problems, and is about ready to chase the DX. — 2CS about to go on with a temporary rig and has a f.b. receiver which is more than half the battle. — 2WU still on c.w. with that copy-book fist. — 2AGD has the 28 Mc. rig peaking and works into ZS and G with good reports. — 2AGY on 14 and 7 Mc. phone. — 2AMM has a change of QTH and reported on active list again. — 2XQ is leaving old QTH and going bush. Guess we will see him at the next Wyong field day though. — 2FP still on 28 Mc. and has new rx with two EF50 for r.f. 74 countries on 28 Mc. phone and awaits VR6AA. — 2CI has nice quality phone on 14 Mc. but in trouble grinding xtals for the 14 Mc. band.

### COALFIELDS ZONE

2KZ as usual exclusively on 28 Mc., not as active as usual, illness in family. — 2XT mainly on 7 Mc. Visited Sydney with 2PZ and 2MK for the W.I.A. Dinner. — 2MK is on 28 Mc. phone only. — 2PZ week-end 7 Mc. phone supporter. — 2DG and 2TY trying vertical antennae, using down pipe, not heard here. — 2ADT nearing his hundred countries post-war, 97 up. Using 14 Mc. more these days with bursts on 7 Mc. — 2YL 28, 14 and 7 Mc. worked recently, 116 countries post-war; conditions improving on 14 and 28 Mc.

### WESTERN ZONE

2IE now on permanently with v.f.o. driving p.p. 807s r.f. and mod., nice rack and panel job. — 2BT uses parallel 807s with p.p. 807s mod., xtal or with a FS6 as a v.f.o. — 2ACT gone a.c., using 110 volt alternator driven by petrol motor. A great improvement on batteries. — 2II, the old inimitable, has a panoramic adaptor, sees them as well as hearing them. The rotary went in a gale but now re-erected and works even better. — 2EL just had his phone going nicely on 7 Mc. and has moved to Earlwood, but gear still packed away. — 2NS says he has been busy re-building, but we suspect he has been scaring the boys at the waterworks?

2JC has nice phone on 3.5 Mc. — 2ACU has new antenna; has also been heard working QRP at Coonamble. — 2RV, the only one heard from Broken Hill, believe most of the others are on 14 Mc. — 2HZ building new receiver, will be nice to look at, even if it doesn't work. — 2LZ still exclusive to the very highs. — 2WH QRL polo, still finds a little time to work DX on 14 Mc. Almost W.A.C. in one hour, only wanted Africa. — 2TG still on 14 Mc. c.w., has 103 countries up. — 2PA seems to go in for marathon QSOs. Had one with 3VV for 2½

hours, then a three way with DX in two other Continents. Pete was either taking advantage of the YF's absence or wants to qualify for the Night Owls' Club.

### SOUTH COAST AND THE TABLELANDS

New Zone Officer for this Zone is VK2ANN, of Bega. The Zone includes that part of the State south of a line drawn across below Botany Bay and east of a line drawn north and south through Cootamundra. Main towns include Yass, Goulburn, Queanbeyan, Canberra, Tumut, Wollongong. Please

## Australia's Largest Stock of All Radio Components

Chokes  
Coils  
Condensers  
Dials  
Intermediate Transformers  
Mose Equipment  
Potentiometers  
etc., etc.  
Resistors  
Soldering Irons  
Speakers  
Test Equipment  
Valves  
Pick-Ups  
Power Transformers  
etc., etc.

Obtainable from

## Bloch & Berber Ltd.

with which is associated  
the

## WELDON ELECTRIC SUPPLY CO.

## 46-48 YORK STREET, SYDNEY

G.P.O. Box 2282 M

Phones: MA 6291 (10 lines)

forward your news to 2ANN, Box 66, Bega. —...— 2ADI who did good work with a few watts from a vibrator is inactive, pending a.c. being connected, only blessing so far is a super power leak at his door. —...— 2ANN is getting gear together for a grand re-build, rhombics and all.

### SOUTHERN ZONE

2JA expects to be active soon. —...— 2QD getting discharged from the R.A.A.F. and should be heard again. —...— 2EU found lost audio, modulates carrier better now, but still some feedback. —...— 2APW active on 7 Mc. Building frequency meter. —...— 2VK re-built xmitter and is active again. —...— 2ANQ had better burn those skis and exercise the ether. —...— 2OJ finished receiver consisting of 6AC7 r.f., 6K8, 6C6 h.f.o., 6SH7 i.f., 6C8 b.f.o., 76, 42, intends trying 6AK5 h.f.o. —...— 2VS now at 2CA Canberra and getting shocks in rx from local broadcast station. Solution Vic, move. —...— 2EH building v.f.o. —...— 2PJ left Wagga to take commercial class. —...— 2NE, new Ham, Mick Cooper is commercial operator at Wagga drome. —...— 2BW very active fixing up haywire. —...— 2TH active on 7, 14 and 28 Mc. and listens on 3.5 Mc. —...— 2AID active on 7 and 14 Mc., re-building sections of rig.

### VICTORIA

Secretary: A. B. D. Evans, VK3VQ, Box 2611 W G.P.O., Melbourne.  
Meeting Night: First Wednesday of each month.

Meeting Place: Radio School, Melbourne Technical College.

#### "FOOD FOR R.S.G.B." APPEAL

It is appropriate that after four months of existence, the Committee should look at the Appeal in retrospect and briefly recapitulate.

First and foremost, the object of the Appeal was to provide a steady flow of food parcels to the R.S.G.B. for distribution among its many members. To be truly representative of the feelings of VK3 Amateurs, the Committee wished that every licenced Amateur in Victoria would donate at least a small sum to the Fund. With the appointment of Country Zone Organisers, it was hoped to make this idea more workable.

Secondly, the Committee, in its operations, has achieved many of its original objectives. Food parcels have been sent at the rate of 20 per month, the Appeal is officially registered as a Patriotic Fund and the Committee have permission to conduct raffles anywhere in Victoria until June, 1948.

The greatest disappointment to the Committee has been the fact that only relatively few country Amateurs are represented in the contributions so far made. Special mention must be made to the North Eastern Zone, under the capable organising of Howard Wohlers (VK3YV), who are doing an excellent job.

Statistics show that the contributions per head for the four months



**I.R.C. Metallized**

# CONTROLS

*with the SILENT SPIRAL CONNECTOR because it's positive - it's positively NOISELESS*

For years servicemen have been looking for better controls — QUIETER controls for those extremely critical duplicate replacement jobs that cannot be handled with standard types. To-day, I.R.C. makes such controls available — backed with all the well known features of standard Metallized units — PLUS the exclusive 5-finger Silent Element Contact PLUS the Silent Spiral Connector which is supplied on all special replacement controls.

**It Eliminates the Most Common source of Noise in any Control.**

The outcome of years of engineering development, I.R.C. brings you this outstanding control improvement — positive and continuous electrical connection between the centre terminal and the adjustment arm. The Silent Spiral Connector spells complete elimination of sliding, metal-to-metal contact in the place where most control noises originate. It means that the I.R.C. Special Replacement Controls are unquestionably quietest because they are the controls having this feature.

The Silent Spiral Connector is made of special wire — sturdy and durable — constructed like a fine watch for a lifetime of the quietest service you can imagine.

**NO SLIDE**

**NO FRICTION**

**NO NOISE**

**QUIETEST!** Because they're the **CONTROLS** in which sliding metal-to-metal contact has been eliminated.

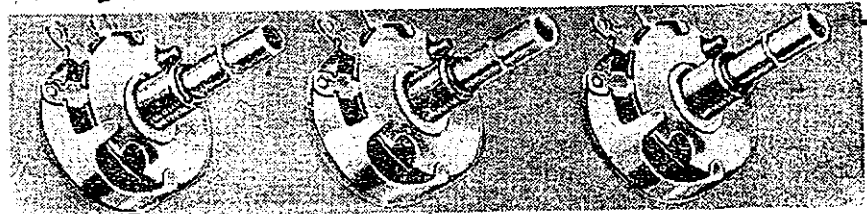

**Wm. J. McLELLAN & CO.**

BRADBURY HOUSE, 55 YORK ST., SYDNEY • PHONE BX2508



has. been.—N.E. Zone, 15/-; Metropolitan, 8/-; S.W. Zone, 3/6.

While these figures are good, the Committee feel that they can be bettered without hardship to anyone, and ask that in future, every Amateur endeavours to at least double his present subscriptions to the Fund.

At the Annual General Meeting on the 6th August, donations from the box collection were £9/0/7. The raffle, of the 5BP1 and a split-stator condenser was won by VK3MM and yielded the sum of £10/9/-. Total receipts to the Fund are now

# Bright Star Radio

VK3UH, Late R.A.N.

1839 LOWER MALVERN  
RD., GLEN IRIS, S.E.6  
Vic.

Phone: UL 5510.

TAYLOR TRANSMITTING  
TUBES. Full Range.

Crystals as Illustrated:

40 and 80  
Metre A to BT  
Cut.  
Accuracy  
.02% of your  
Specified  
Frequency  
£2/12/6  
20 Metre zero  
drift, £5.  
Crystals  
Reground,  
£1 each.

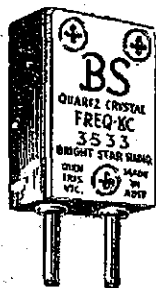

S.A. Hams may obtain crystals from A. G. Healing.  
Box 645 A'elaide

West Australian, Messrs.  
Atkins W.A. Ltd., Perth.

Filament, Power and Modulation Transformers made to order. Guaranteed.

Reasonable Prices  
Prompt Deliveries

£135/13/11, the total expenditure £93/8/8, and cash in hand and bank £42/5/3. The one hundredth food parcel has also been despatched to the Secretary of the R.S.G.B.

Zone Organisers are as follows:—3YV, North Eastern; 3QC, South Western; 3QZ, Eastern; Kevin Duff, Central Western.

Please send your donations, made payable to the "W.I.A. Food for Britain Patriotic Fund," to your Zone Organiser or to VK3UM, the Appeal Secretary.

All Victorian Amateurs are referred to the August issue of "Amateur Radio" for details of raffles, etc. Tune to the weekly broadcast from 3WI for further news of the Appeal.

## TECHNICAL ADVISORY COMMITTEE

**Executive.**—At the last meeting nominations were received for office-bearers for the forthcoming year for submission to Council. Victorian Council have approved the following appointments for 1947-48:—

Chairman, Mr. G. Glover (3AG); Vice-Chairman, Mr. C. Quin (3WQ); Secretary, Mr. W. Mitchell (3UM); Asst. Secretary, Mr. D. Gray (3ADG); Technical Editor, Mr. K. Ridgway (3CR); Council Representative, Mr. D. Gray (3ADG).

The Committee have laid down a programme of operation for the forthcoming year including the formation of a new Group, and details of T.A.C. policy will be given in later issues of the Magazine.

**Modulation Technique Group.**—It was decided to form a new Group this year which will deal with modulation, including the technique of the recently-released i.m. and pulse transmissions. Anyone interested in this Group should contact the T.A.C. Secretary, VK3UM. The meeting night has yet to be finalised, but would tentatively be the third Wednesday in the month.

**V.H.F. Group.**—At the last meeting of this Group, the problems associated with V.H.F. antenna design and operation were discussed by 3NB and 3XA. 3NB dealt with stub-fed and 3XA with folded dipole feeds for antennas. The next meeting will discuss V.H.F. transmitters and everyone interested is cordially invited to attend, bringing along their own rigs, if portable. Meeting night is the first Wednesday.

**Receiver Group.**—A very instructive demonstration with the c.r.o. attached to the i.f. stages of a receiver was given at the last meeting of this Group. Observations were made of 7 Mc. phone signals illustrating overmodulation and splutter. Its value was shown, as several stations who claimed clean modulation, were seen to be either overmodulating or to have a bad splutter present on their signals. Meeting night is the fourth Wednesday.

**Bush Fire Emergency.**—A confer-

on the 14th August, at which representatives from various Government Departments and the W.I.A. were present, did much to clear the air for future developments in this field. The conference was high in praise of the work done by the Amateur, and approved of the suggested W.I.A. plan of action. Crystals are now being distributed to base stations of the Network.

**Frequency Measuring Service.**—The T.A.C. are interested to know what the general feeling is regarding the use of phone as well as c.w. for these transmissions. Let the operator at 3WI know how you feel about this idea.

## NORTH EASTERN ZONE MEET AT SHEPPARTON

July, 1947, was the month we North Eastern Zone Amateurs decided to hold a Convention at Shepparton and endeavour to justify our present and future existence as members of the Amateur Fraternity.

The date—27th—was pleasant in its anticipation, and apart from the rather cold wind and the downpour of rain from 1800 hours onwards, Nature was with us all the way.

The boys began reporting at the Star Theatre Supper Room from 0930 hours and by 1000 hours we were ready to commence with the meeting to inaugurate activity in the North Eastern Zone.

Comfortably seated around a blazing log fire, we had present VKs 3ABG, 3APB, 3ASG, 3AT, 3CN, 3DW, 3GD, 3HP, 3JK, 3KR, 3SN, 3TM, 3TS, 3UI, 3WZ, 3XZ, 3YV, also Les Archibald (senior technician 3UZ), and Associate Members Les Taylor and Ron Anderson. Apologies were received from 3ACW, 3BP and 3DG who, although absent, were not forgotten (hope to see you next time chaps).

Howard Wohlers (VK3YV) was unanimously elected President with Ken Rankin (VK3KR), Secretary and Treasurer.

Business completed and meeting declared closed, we moved about two miles out of town for a demonstration of 50 Mc. gear by 3UI and 3ABG. Situated one and a half miles apart with lots of gum trees in between, S6/7 signals were received by 3UI after 3ABG had placed his antenna vertical to coincide with that used by 3UI. Prior to the change, the horizontal position of antenna at 3ABG's end was not satisfactory. 3UI's signals were received S9.

Brief description of gear used follows:—3ABG, Tx: 1K5 c.o., 1K5, 6SN7, 807 plate modulated with 1A6 and 6V6. Rx: 6AC7, ECH35 into FS6 at 5 Mc. Antenna: half wave doublet. Power input: one watt from vibrator. 3UI, Tx: 8370 crystal, 6G6 plate grid osc. tripler, 12A6 doubler, 832 final. Input 12 to 15 watts. Mod.: 6SS7, pair 12A6s plate modulation. Power supply: 12 volt battery and type 19

genemotor. Rx: 9003 r.f., 9003 mixer, 9002 osc. with 3 i.f. stages on 10 Mc. Antenna: quarter wave vertical.

Further interest centered around Type A Mark 3 equipment brought along by 3XZ and 3ASG, and although no contacts were made on 7 Mc. in the limited time on the programme for demonstrations, the only distractions were caused by "cameramen."

A six miles run to Congupna and inspection of 3SR under the capable direction of Chief Engineer Pat Bennett. (3APB), proved a very acceptable diversion from Ham Radio. The highlight of the day, the "one item up our sleeves," was the visit to the (QRP?) station Radio Australia. To call it an eye-opener is being just plain reticent, words fail to express just how "goggle-eyed" the gang became on entering the door of this outstanding achievement in radio.

Six amps. in plate circuit of one transmitter (50 KW) was one thing, but twelve and a half amps in the plate circuit of another transmitter (100 KW) was just too much for any dyed-in-the-wool Ham. An introduction to 20 kilowatts of audio left us spellbound. Maybe we haven't been around enough! Maybe some of you fellows would like to see it? You're welcome. The many directive antenna systems suspended from steel masts 210 feet in height did nothing to alleviate our amazement. The push button change-over of these antennas was just a dream.

Fluorescent lighting and air conditioning throughout the transmitter building were just insignificant accessories. Capably piloted throughout the maze of equipment both above and below ground level, and for the splendid commentary, our thanks go to Bert Buck (3TM) and Dud Bell (3SN)—both senior technicians in this north eastern masterpiece.

Time and tide wait for no man and the lads were looking homewards, rain threatened, so with sincere handshakes, "cheerios," "till we meet again," the party broke—so did the storm!

Ever known a Ham gathering without incident? 3KR lost a fan belt and realised his radiator was empty on his way over in the morning, but 3TS found his radiator dry inside on his return journey some miles from Shepparton, and the rain just pelting down.

Thanks are extended to all members for their splendid co-operation in making Convention Number One an outstanding success for Amateur Radio in general and North Eastern Zone in particular.

#### WESTERN ZONE CONVENTION AT STAWELL

The Convention was held on 10th August at the Wimmera Cafe, Stawell. Those present being VKs 3AGB, 3TA, 3ATR, 3DP, 3AX, 3AKP, 3AKW, 3FJ, 3SA, 3YW, 3GN, 3HL, Ray Jenks, Charlie Richardson, Kevin Duff, and Eric Hardinge.

The meeting opened with 3TA in the chair and after a short explanation of the purpose of the meeting by 3TA, the election of officers for the new Western Zone was proceeded with. Office-Bearers elected were:—President, Mr. George Turner (3GN), Ararat; Vice-President, Mr. Trev. Rodda (3ATR), Warracknabeal; Secretary-Treasurer, Mr. Cecil Waring (3YW), Stawell; Committee Members, Mr. E. Perkin (VK3EP), Bendigo; Mr. W. Holland (3XC), Maryborough; Mr. H. Peters (3AKP), Stawell.

Zone membership fee was fixed at 2/6 per annum to cover incidental costs in running the Zone.

3TA spoke on behalf of the Amateur Food Appeal for G Hams and Mr. Kevin Duff was appointed Zone Organiser (Kevin, by the way, is just waiting for his call sign).

Long discussion centered round a motion forwarded from the N.E. Zone to the effect that Zone membership fees should be subtracted from the W.I.A. annual subscription, but in view of the technical services provided by the W.I.A., and possibly not even dreamt of by country Hams it was unanimously agreed not to take any action in the matter.

Emergency network matters were discussed, but this matter was left over until further information was forthcoming from the Melbourne conference.

The matter of further Conventions was left in the hands of the Committee to arrange two Conventions

## TECHNICAL BOOK & MAGAZINE CO.

297-299 SWANSTON STREET, MELBOURNE

(Opposite Old Melbourne Hospital)

Central 2041, Melbourne, C.I.

We can arrange subscriptions to any of the following magazines:

### AMERICAN.

RADIO: . . . . .	25/- year	COMMUNICATIONS: . . . . .	24/- year
Q.S.T.: . . . . .	27/- "	RADIO NEWS: . . . . .	40/- "
C.Q.: . . . . .	25/- "	RADIO CRAFT: . . . . .	22/- "
SERVICE: . . . . .	24/- "	SCIENCE DIGEST: . . . . .	23/6 "
F.M. & TELEVISION: . . . . .	48/- "	PROCEEDINGS INST. OF RADIO ENGINEERS . . . . .	88/- "
ELECTRONICS: . . . . .	97/6 "	POPULAR SCIENCE: . . . . .	23/6 "
SPECIAL RATE FOR THREE YEARS: . . . . .	195/-	POPULAR MECHANICS: . . . . .	23/6 "

### ENGLISH AND AUSTRALIAN.

WIRELESS WORLD: . . . . .	25/- year	WIRELESS ENGINEER: . . . . .	42/- year
PRACTICAL WIRELESS: . . . . .	13/6 "	ELECTRONIC ENGINEERING: . . . . .	33/- "
AUST. RADIO WORLD: . . . . .	10/6 "	RADIO AND HOBBIES: . . . . .	6/6 "
AMATEUR RADIO: . . . . .	6/- "	SHORTWAVE MAGAZINE (English): . . . . .	25/6 "

FOREMOST IN AUSTRALIA FOR TECHNICAL BOOKS.

*There's always a leader*



**AMALGAMATED WIRELESS VALVE COMPANY**



In Polar exploration, only leadership, born of skill and experience, can be depended upon to win through. In electronic communication, valves are the cornerstone from which all research develops—Radar to seek out the safe channel; radio compasses to plot positions accurately; echo sounders to gauge ocean depths, and constant communication with bases to keep informed. In all these devices, Radiotron Valves provide the pulse beat, facilitating the work of pioneers and improving radio in all its applications.



PTY. LTD

per year, possibly to co-incide with field days of other Zones.

After the business meeting, a very enjoyable and instructive afternoon was spent in viewing 16 m.m. talkie films, kindly made available by 3KN, on the subject of f.m., all present voted the film the clearest and easiest understood explanation of f.m. ever put before them and expressed their appreciation of 3KN's generosity in making the film and the talkie projector available.

At the conclusion of the f.m. film, Mr. Eric Hardinge produced some

absolute gems in the way of 16 m.m. color films, these consisted of shots of the Grampians, and some marvelous works on flowers. They were quite the best color films seen to date, and Eric's interest in coming along and showing these reels to the gang earned our warmest thanks, although his efforts as a poet were noted to be unusual.

After the films the meeting adjourned to the dinner tables where an excellent repast was enjoyed by all those present. 3AX unfortunately could not stay for the dinner as he had to be back on shift at 3LK, but it was good to see Harold back with the gang again after all these years.

An animated discussion took place at the table as to the oldest Ham present; 3HL winning easily with a starting date of 1924. Allan remarked you only had to count the hairs in his head to see the oldest stick out.

The important subject of Zone hook-ups was considered, and it was decided to run it on the second Sunday of each month on 7050 Kc. at 10 a.m., it was suggested that other Zones might consider the idea of a spot frequency with the idea of cutting QRM.

The Convention ended about 1820 hours with a mass raid on 3AKP's shack, where a hectic discussion waxed and waned as to the merits of Keith's receiver.

Western Zone Members! Two important things to remember. (1) The Zone Hook-up 10 a.m. second Sunday in month on 7050 Kc. (2) Would those members of the Zone not present at the Convention please send their membership fee to C. C. Waring (VK3YW), 12 Skene St., Stawell.

#### Personalities

3GN at present time having a good time with a Type 3 Mark 2, getting such good results on 3.5 and 7 Mc. phone that the big rig is in the dust bin. Ask George how to make yourself heard on 3.5 phone. — 3TA still putting out clean phone on 7 Mc., can even be heard on 3.5 Mc. on rare occasions. Byron is a triode addict. If you want to hear some 150% modulation just ask him "why not use a beam tube." — 3DP a busy guy on 7 Mc. c.w., puts out a good signal and raises his share, like me thinks 7 Mc. is a crook band at night and has his eye on 14 Mc. — 3AX, good old Harold, 14 years' break and he still comes back. — 3AKP works some amazing DX on 7 Mc. with a horizontal 14 Mc. zepp. Has now moved to a new QTH and has a 7 Mc. zepp so we shall see.

3AKW between running the farm and busting up tubes at 3LK, Bill puts out a good cathode modulated signal on 7 Mc. — 3HL also up to his eyes in farm and has a peck at the DX on 14 Mc. with two nice long V beams. Has been on 7 Mc. c.w. lately. — 3YW at long last

has two masts up, pushed the 60 footer up about six weeks ago (plus assistance from 3AKP, etc.). Very f.b. on 3.5 and 7 Mc., however the old 14 Mc. vertical is still the goods on 14 and 28 Mc. — Kevin Duff will soon be giving 3GN a run for his money in Ararat, threatens to put r.a.c. on the plates if George takes up too much room. — 3FJ and 3SA are both at present living in Melbourne, however it was good to see them again and Charlie certainly puts out a nice phone on 7 Mc. — 3EP puts out a very nice signal on 3.5 Mc. phone, 12 watts and a P.M.G. mike, a good show Ted. — 3XC, well Willy (or is it Clive) will have to explain why he did not get to Stawell. (We heard all about it on 7 Mc.—Ed.)

Western Zone notes secretary is the unfortunate 3YW, so let's have all the news boys in time to catch the Magazine on the 15th of each month.

## QUEENSLAND

Secretary: R. Thorley, VK4RT, Box 638J, G.P.O., Brisbane.

Meeting Place: State Service Building, Elizabeth Street, City.

Meeting Night: Last Friday in each month.

The City-Country Contest held by the VK4 Division on the 3rd August was a notable success, if one may form an opinion on views heard aired on the Ham bands. At the time of writing VK4ER seems to be a comfortable winner, but all logs are not yet in.

What with the Royal National Show and everything, your scribe has very little news this month, but as the result of a change-in employment, hopes to be a more or less permanent resident of Brisbane now, and as a result should be more in touch with developments than hitherto.

Speaking of the R.N. Show it has been suggested that the W.I.A. run a stall at future exhibitions. The matter will be considered by Council, and if the scheme can be managed it will receive consideration for next year.

Reports on VK4WI's reception continue to flow in, several being received of late from New Guinea. The use of dual frequencies (7 and 14 Mc. bands) has made a material contribution to the effectiveness of the coverage over the State.

Observed Arthur Johnson (4PX) doing a good job at the ABC exhibit at the R.N. Show, likewise 4LT was also putting over a good line of sales talk for his firm.

Eric Lake (4EL) now has 130 countries up his sleeve. 4PR has become a temporary resident of Guam, with the U.S. Forces, while 4VR, late a PK, is once again in Brisbane.

# Low Drift Crystals

FOR

## AMATEUR BANDS

ACCURACY 0.02% of  
STATED FREQUENCY

3.5 M/C and 7 M/C

Unmounted .. £2 0 0

Mounted ... £2 10 0

12.5 and 14 M/C Fundamental Crystals, "Low Drift" Mounted only £5.

Spot Frequency Crystals  
Prices on Application

Regrinds ... £1 0 0

THESE PRICES DO NOT  
INCLUDE SALES TAX.

## Maxwell Howden

VK3BQ

15 CLAREMONT CRES.,  
CANTERBURY, E.7.

# SOUTH AUSTRALIA

Secretary: E. A. Barbier, VK5MD,  
Box 1234 K, G.P.O., Adelaide.  
Meeting Place: 17 Waymouth Street,  
Adelaide.  
Meeting Night: Second Tuesday of  
each month.

A fellow Ham told me this month that he was a full "wake up" to these W.I.A. Council chaps who were able to get disposal gear whenever they wanted it. In fact he told me that every Council member had at least one receiver and transmitter in his shack that had mysteriously arrived from disposals in Melbourne. This intrigued me and I immediately dashed off home to find my new receiver and transmitter which would be sent airmail from disposals. I was very disappointed as no disposal radio had arrived for me. I thought all this over and decided that my fellow Council members were holding out on me. I determined to keep my eyes open when I visited their shacks and when I discovered these mysterious disposal radios I would give them a piece of my mind. I am still keeping my eyes and ears open but so far I have not discovered anything. Should any of you chaps reading this discover any clues would you please contact me and blow down my ear, because so far all I have received from being a Council member is a lot of hard work and plenty of abuse, and I would so love a disposal re-

ceiver and transmitter all for myself, like other Council members.

You remember the Broken Hill Boys' Club and the fact that the VK5 Division had sent a two guinea donation to help them on their way with their radio section? Well, we received a very appreciative letter of thanks from the Rev. Guthberlet who is the Superintendent of the Club. This Club is doing a real job among the youth of Broken Hill, and one of the few Clubs in Australia carrying a course in radio which is available free to any youth interested. What about it Divisional Council Members? Your Division won't miss two guineas and it will help to keep Amateur Radio alive among the up and coming youth.

The general opinion among Hams in VK5 regarding the abolition of the probationary period for newcomers was that it is a retrograde step, but the newcomers were overjoyed and celebrated the abolition in no uncertain manner by coming on the air with phone in record time. One embryo Amateur said he did not think he would worry about the code part of the examination as it would be wiped out before long anyway, which would be all to the good as it was an old fashioned method of communication!

Several non-members of the W.I.A. cannot see any advantages in joining the Institute but the same non-members are not averse to using the frequency measuring facilities and

the post office box number for their QSL cards plus any other tit-bits available.

The "William Tell" antenna ("bow and arrow" to you) seems to be gaining in popularity in VK5. Quite a number of these installations can be seen around the suburbs, although I would not be "game" to put an apple on my head and let some of them have a shot at it!

The standing joke "that one does not have to be silly to be an Amateur, but it helps a lot," wears a bit thin when the people who say it the loudest are the first to ask the Ham to have a look at their broadcast receiver because "it is not as loud as it used to be, you know."

Radio in VK5 this month seems to be in the doldrums as very little activity has been apparent on any band. The wet and wintry weather probably has had a lot to do with it as the fire certainly has looked very inviting these nights. Methinks the first flush of enthusiasm of being on the air is fading, and everybody is finding their level again. This is all to the good as there is more in Amateur Radio than "Hello CQ, Hello CQ."

Realising that the prevalent QRM is at its height during week-ends on all bands, many Amateurs are spending their time in making adjustments and testing during these periods, thus unwittingly adding to the QRM. The answer is, of course, the dummy

## RED LINE EQUIPMENT for the F.F.R. AMPLIFIER

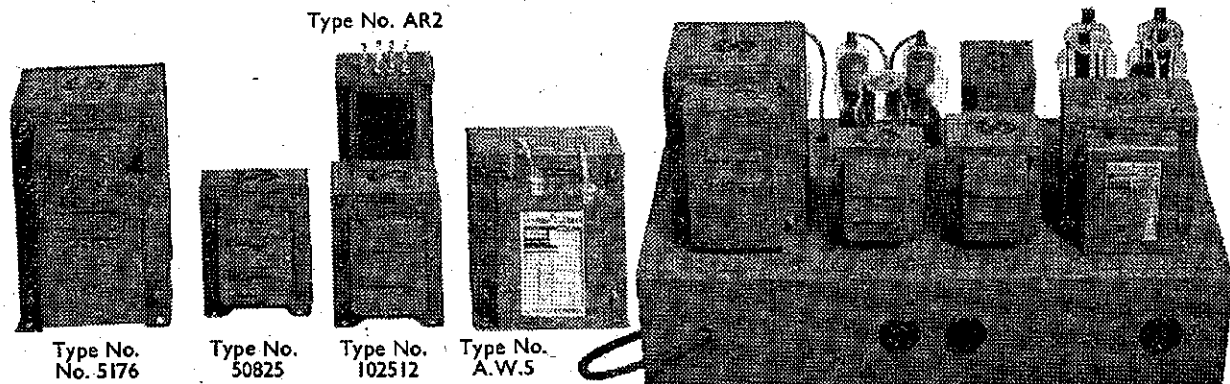

### RED LINE EQUIPMENT FOR THE AMATEUR INCLUDES:

- ★ High Tension Plate Transformers.
- ★ Low Tension Filament Supplies. (Insulated up to 4000 volts if required).
- ★ Class B Driver Transformers.
- ★ Multi Impedance Modulation Transformers.
- ★ Heavy Duty Power Supplies.
- ★ Swinging and Smoothing Chokes
- ★ Wide Range Audio Equipment
- ★ Frequency Dividing Networks

# SWALES & SWANN

Technical Service,  
Wholesale and Manufacturers:

A. T. SWALES, Cent. 4773  
2 Coates Lane, Melbourne.

Trade Sales: ALLEN SWANN  
MU 6895 (3 Lines)  
157 Elizabeth St., Melbourne

aerial, and it is surprising how few are in use for testing, etc.

It was quite pleasant to see "Tommy" (5IT) at the meetings again although he did look like a fish out of water down among the members. Somehow or other he always looks out of place anywhere but in the "chair." Whilst on that subject Hal Austin (5AW) is doing a swell job in the chair, and believe me, with the attendance lately it is a man-sized job.

The monthly general meeting for August took the form of an entertainment evening and over 100 members and visitors were given an opportunity to hear the BBC transcription titled "The Story of Radar." Most members attended with somewhat mixed feelings, as expecting a gathering of Amateurs to sit still without talking for an hour and a half was asking something from a BBC transcription. The members not only sat still, but at the conclusion of the disc they applauded to a man what was undoubtedly the finest one and a half hours lecture that has ever been delivered to the W.I.A. Mr. Colin Ferguson moved a vote of thanks to Mr. F. Wreford (5DW), the ABC and the P.M.G.'s Department to whom the success of the evening was due. Visitors present included Miss P. M. Hubbard (an ex-W.A.A.F.) who is keenly interested in Amateur Radio and desirous of honorary membership, Messrs. Leonard (5LT) Cunningham (3OV), W. Bland (representing the I.R.E.), Miller, Marshall (N.S.W.), Francis and Shultz. Apologies were received from Cliff Moule (5CX), I. Thomas (5IT) and Jack Lester (5LR).

The opportunity was also taken to present to Mr. Reg Galle (5QR) the I.R.E. trophy for his outstanding work on the V.H.F. bands. Mr. W. Bland (I.R.E.) made the presentation on behalf of the donors (The Institute of Radio Engineers), and Reg suitably replied, giving as the reason for his success the fact that he was just lucky to have been around at the time. Modestly put Reg, and you almost convinced me you were only waiting for a bus at the time! Anyway sincere congratulations from all members for a job well done.

It was announced at the meeting that a letter had been received from Johnny East in Singapore thanking the S.A. Division for the favours and kindness shown to him during his short stay in VK5 as a member of the H.M.S. "Glory."

It was also announced that Regulation 38 of the Wireless Regulations is very definite about the transmission of any matter that can be conveyed over or by any of the communication systems provided by the P.M.G.'s Department. In view of this the Council is obliged to abandon any further investigations of recording apparatus for the purpose of re-broadcasting lectures, etc., over 5WI for the benefit of country members.

The YL visitor at the meeting modestly sat at the rear of the room and it was not until the President, Hal Austin (5AW) announced Miss Hubbard that the gang knew of her existence. Most of them nearly fell over backwards trying to see the YL, and there was quite an uproar for a few minutes. After seeing the look on some of the "wolves" faces toward the front rows, I can now understand why Miss Hubbard sat at the back of the hall. Just in passing fellows, my talk with her was purely for the purposes of this magazine, after all I am the correspondent. Woo! Woo!

The practice of having visitors rise to their feet at the meetings to be introduced to members is creating favourable reaction, but apparently some of the visitors have guilty consciences or something judging by the look on their faces. Of course we could ask "Doc" to retire during this portion of the proceedings! Talking of "Doc" (5MD) there is no truth in the rumour that he had occasion to speak crossly to one of his "boarders" for doing a little overtime work with an hacksaw because the noise spoilt reception on 28 Mc.

The local commercial broadcasting stations' change of close-down hours from midnight back to 11.15 p.m. each night was greeted with whoops of delight from the BCL interference chappies, who may now come on phone or c.w. three quarters of an hour earlier. What about the ABC you say, well a little BCL interference would probably create a wider listening public.

The attendance at the monthly meeting was a little below average, due probably to the rain and cold. Old-time members will smile at this, remembering the time when 25 was a good attendance. Why we know the attendance was a little down is because only one or two members were sitting on the floor!

## WESTERN AUSTRALIA

Hon. Secretary: W. E. Coxon, VK6AG, Howard St., Perth, W.A.  
Meeting Place: Builders' Exchange, St. George's Terrace, Perth.  
Meeting Night: Second Monday in each month.

The July meeting held on the 14th was well attended, those present being:—6WH, 6RB, 6MY, 6LM, 6FW, 6AS, 6WT, 6RS, 6DN, 6CP, 6YZ, 6SD, 6RG, 6DF, 6BK, 6HL, 6WS, 6EV, 6DD, 6KW, 6SA, 6HT, 6MB, 6FL, 6DJ, 6GA, 6GB, 6PW, 6RU, 6OR, 6FR, 6AG, 6LS, 6TB, 6NL, 6GM.

A very interesting evening was held, during which 6HL showed an American made f.m. transmitter. As f.m. is in the "air" these days, this transmitter created quite an interest.

6RU demonstrated the use of the Class C Wavemeter and the correct procedure to adopt when calibrating it against known standards. 6SA showed an interesting a.c. power pack

that fitted in place of the vibrator pack for the same wavemeter. 6AG topped the evening with a demonstration of how to erect a 60 feet high, 1" diameter, water pipe mast. To assist in the explanation, Wally used a scale model approximately 8 feet long. This model proved the points stressed and all the VK6 gang present went home much the wiser for their evening spent at the W.I.A. meeting.

The August meeting was held on the 11th, and the attendance swelled to almost room capacity. Those

## SPECIALS! WHILE THEY LAST

0—5 Amp. Thermo  
Ammeters, 17/6

### METER SCALES

Suitable for Pullin "Disposal" meters. Volt-M.A.—Ohm or special Multi-meter scale.

Either type, 2/-, post free.

### POWER TRANSFORMERS

Wound on extra large core. Any voltage or amperage—Reasonably priced.

7-DAY DELIVERY  
SERVICE

Multi-Match modulation Transformers. 75-watt. In die-cast metal clamps.

Write for full details.  
£4/19/6. DELIVERY EX  
STOCK.

### CHASSIS — RACKS — PANELS

Any size, any gauge. Write enclosing full particulars.

Quotation forwarded by  
return mail.

VK3NU

## Major Radio & Electrical Co.

189 GLENFERRIE ROAD,  
MALVERN

WM 1814 U 9354

present were 6WH, 6HL, 6LW, 6DF, 6RU, 6DJ, 6WS, 6LS, 6EV, 6RF, 6TX, 6KW, 6SA, 6NL, 6DD, 6MB, 6GJ, 6JH, 6RJ, 6FR, 6CP, 6FW, 6YZ, 6AS, 6GA, 6RS, 6DN, 6FC, 6CM, 6GC, 6OR, 6PW, 6BG, 6KE, 6LM, 6JN, 6AG, 6GM and W6DJP. After a short business session reports were received.

6WH, Country Liaison Officer, reported a new country Radio Club being formed in Geraldton with 20 members. Encouragement for training A.O.C.P. candidates is being practically demonstrated by this Division by a donation of a suitably inscribed meter to the Club. This meter is to be held by the Club and presented at the end of the first A.O.C.P. class, to the best student.

6RU, QSL Officer, reported good business in QSLs and thanked 6MB for donating a new metal QSL box to the Division. 6EV reported on the function of the Disposals and Exchange Bureau. Valuable help to the members in purchasing gear has been obtained via 6EV since the inception of this section.

The rest of the evening was spent by listening to an interesting discourse by 6JH (J. Horne) on his travels as a wireless operator on a ship during wartime. Various chuckles and laughter were heard during this very interesting and at times humorous talk. 6RU rounded off the evening with a demonstration of his new double conversion band-switched superhet. Everyone went home again feeling that an evening had been well spent.

### LOG SHEETS

The new Log Sheets printed locally for this Division, along the lines of the A.R.R.L. Log Book, are available to members. These sheets, together with binders, are the answer to our Log Book problems. Sheets are priced at 2/6 per 100 and binders 1/10 each.

With a combination of these, a complete Log Book for any period (example 1 year's operation) can be bound in a few minutes and will last indefinitely. Supplies are obtainable from the Secretary: 6AG, 7 Howard Street, Perth.

### PERSONALITIES

6DD has been busy building a new v.f.o. around his Bendix Wavemeter.

John reckons to be on the air again shortly. — — — 6JS is busy building his new shack. Slow, but sure, is Jack's motto. — — — 6MW is not so active these days. The weather too cold Bill? We guess a fire is nicer these nights. — — — 6WT is keeping 7 Mc. warm with a f.b. phone signal. Congratulations Dave. — — — 6NL busy designing a new super blooper receiver. Vic is seen daily pondering over plans and weighing the 4-gang condenser he proposes to use. — — — 6GM is not heard much these days. We have reason to suspect he is cooking up some new contraption. — — — 6LW, the first VK6 to go f.m. Yes Wally was up to the early hours when word came through that f.m. was a reality and was on the air next morning with it.

6KW prefers the fire also these cold nights, and is not heard so frequently. — — — 6RU is back on again after a few weeks' retirement during building of his new super de luxe receiver. — — — 6BW is paying W.A. a visit again at last. That's how it seems to us: Mick seems to be away from VK6 more than in it these days. — — — 6RO still a "left at the post" Ham. Bert still listens and plays with the super blooper. — — — 6AW, a call well known to pre-war Hams. Andy Watkins is no longer the owner as he is in Cairns with Civil Aeradio. Sends his best regards to VK6 via VK6AX.

6TX is still a SWL and doesn't seem to be making the promised progress to put Mosman Park on the air. What about it Jack? — — — 6CM has been

### DISPOSALS GEAR RE-VAMPED

It may be of interest to "522" owners to hear of what 4HR has done with his. Tibby has retained both tuning condensers and has added a separate oscillator unit covering the range from 60-80 Mc. The gang condensers are used to tune 50 and 166 Mc. input r.f. and mixer channels with the second harmonic of the oscillator used for injection on 166 Mc. The oscillator, which fits in the space formerly occupied by the 12AH7 harmonic amplifier is a 6K7 electron coupled, with coupling to the mixer channels via a link through a condenser from the 6K7 plate. The result is a nifty dual band receiver with a choice of input from either band to the 12 Mc. i.f. channel,

on 7 Mc. lately with a much more fully modulated signal. Keep it up Bill. — — — 6MU very quiet these days. We haven't heard from Merredin lately. What's the news up there Mal. How about some notes for "A.R."? — — — VK3KU has promised VK6 another visit in early September. It's a case of the "wildflowers that bloom in the spring" and Howard hopes to see them in full bloom. Of course that's not all he's coming over for, is it Howard?

## PUBLIC SERVICE VACANCIES.

Applications are invited for the following position (all appointments are subject to the Public Service Act and Regulations thereunder): —

### DEPARTMENT OF PUBLIC WORKS.

**RADIO SUPERVISOR, Southern Electricity Supply, Goulburn.**  
Salary £495/14/8 to £595/14/8 annually (w.e) according to qualifications and experience.

Working hours normally will be 9 a.m. to 5 p.m. with no Saturday work. Applicants should be experienced in the construction, testing, adjustment and operation of radio transmitting and receiving apparatus, and preferably have had some experience of carrier telephone equipment. The possession of the Diploma of Radio Engineering of the Sydney Technical College or of any of the Certificates issued by the Postmaster General's Department or of other similar technical qualifications would be an advantage.

Employment in terms of Section 44 of the Public Service Act, 1902.

Applications should be made on a form obtainable at the Office of the Public Service Board, 19 O'Connell Street, Sydney, or from Clerks of Petty Sessions in country districts, or Commonwealth District Employment Offices, and should be forwarded direct to the undersigned.

A. D. WYLIE,

Secretary, Public Service Board.



# A.G. HEALING

LIMITED

MANUFACTURERS AND  
DISTRIBUTORS FOR.....

Electrical and Testing Instruments for all purposes made to British Standard specifications. Each instrument is accurate, + or - to 2 per cent., and parts are heavily plated to prevent corrosion even under tropical conditions. "Healing" Electrical Meters equal the best imported types and will give accurate service for long periods under the most exacting conditions.

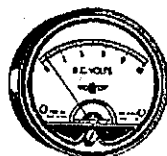

No. 10A round production mounting Black Bakelite Case.

Type No. 30A 4" square semi-flush Black Bakelite Case.

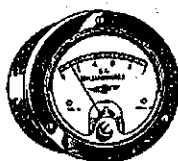
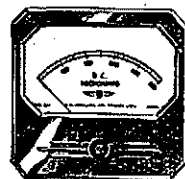

No. 20A 2½" round flush mounting Black Bakelite Case.

These, and all other Healing Radio Electrical Testing Units, are manufactured in our own factories and available from A. G. Healing Ltd.

OTHER INSTRUMENTS INCLUDE:

Oscillators — Multi-Testers — Signal Tracers, etc.



ALSO MANUFACTURERS AND DISTRIBUTORS FOR

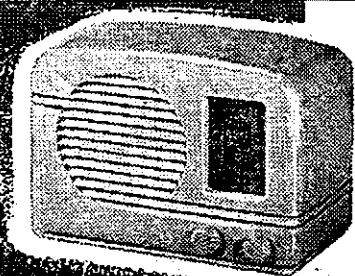

## Golden Voice RADIO

A. G. HEALING LTD., MELBOURNE, SYDNEY, ADELAIDE

H2.FP

## TASMANIA

Secretary: J. Brown, VK7BJ  
12 Thirza Street, New Town.  
Phone W 1328.  
Meeting Place: Photographic Society's Rooms, 163 Liverpool Street, Hobart.  
Meeting Night: First Wednesday of each month.

It may have been the firewood famine and the promise of 7CW's radiators, but the weather had no apparent effect on attendance at the last general meeting.

Proceedings opened with the announcement of, and much conjecture on, the imminent issue of new regulations, in the interpretation of which Tasmanians should soon have access to the "good oil." Peter Dunne, who fathered the first lusty but somewhat ambiguous infant is, we understand, to be the new Radio Inspector in these parts.

Particulars were given of a recent tour of three or four shacks by Mr. Duthie, M.H.R., who indulged in a QSO at 7CW and morning tea at 7LJ, thereby learning something of Ham Radio AND morning tea at their best. While on the subject of publicity, 7NC made some timely remarks on the need for press articles which give a true picture of our activities. A prepared release by the Institute would be less misleading to the public than some of the strange results of journalistic imagination we have all seen at one time or another.

The Secretary of the Tasmanian Division of the I.R.E., who is one of our members, suggested that as a local arrangement, the W.I.A. would be welcome to attend I.R.E. lectures in order to avoid duplication of material which is of interest to both Institutes. This met with immediate approval, and a reciprocal invitation was issued to I.R.E. members for such occasions as would be of interest to them.

Arising out of this, it was decided to re-open the question of affiliation with the Tasmanian Association of Scientific Societies, and 7LL was appointed to act as our delegate at their next annual general meeting.

7LL then put in a word on behalf of the Red Cross blood bank, at which he performs the rites, and was rewarded later by the appearance of several recruits.

Following the passing round of the Food-for-Britain hat, which netted something over five pounds, some films lent by the Education Department occupied the rest of the evening in place of the usual lecture.

Three of our Associate Members, Bob Fulton, Ted Cruise and L. Edgington, have received good news about the A.O.C.P. and are now preparing to add transmitters to their modulators—well, anyway they are getting ready to go on the air.

Someone who fell into the same error heard 7OM and 7CW getting all set recently for the VK7 fortnightly

ragchew—right time, right night, but the wrong week!

7YY wonders if there is a prize for the worst location. Every time he hangs out an extra foot of wire the hydro people promptly box it around with power lines, presumably to get their ergs back and sell them to someone else. And if the proposed V.H.F. converter goes up on a patient XYL's kitchen cabinet to join the Kingsley and 80 watt rig, it might well prove to be the straw that breaks the camel's back.

7KA (Syd Dahl, ex-4KA) has acquired a Type 3 Mark 2, a handy little job for his trips around in Big Bertha. He uses this vehicle to iron the humps out of Tassie in order to survey the place.

Lengthening daylight hours are bringing an improvement in DX conditions, and one also begins to think once more of field-days which, while not claiming to make profound contributions to science, are still among the best things we've seen in the way of healthy social functions.

### NORTHERN ZONE

There has been very little activity in this Zone since last month's notes were written. Most of our members have either been revamping existing rigs or building new gear.

7RK has spent considerable time perfecting a key click filter and tests have proved that the time was not wasted. Has also been having quite a lot of fun experimenting with antennas. Ray is now on phone once more. — — — 7DS is still having trouble with his rig and complains that he has insufficient time to chase the bugs out. — — — 7BQ is busy getting on to 50 Mc. in a big way.

The transmitter is completed and working well, and a three element beam is now being constructed, trouble however is being experienced with the converter. Len has just returned home after a week in Melbourne.

7LZ is still active on 14 and 28 Mc. Has now increased the height of his three element rotary beam to fourteen feet. The W8JK has now been discarded. Although 7LZ got his existing rig working on 50 Mc., it did not prove satisfactory and a separate transmitter is now being built. — — — Conditions in the North have been very poor for the last couple of months, however 14 Mc. is now more consistent and on 28 Mc. an occasional South American can now be heard. The South Africans are also proving good contacts after 4 p.m. — — — George Elliott (G5LI) advises that Ron Hope is sailing from England on the 29th of August. George also wishes to be remembered to 7CW, 7LJ and 7YL.

— — — Nothing has been heard of the coast gang, however stations have been heard calling 7XL and 7JT. We hope to be arranging skeds with 7AB and 7XL on 50 Mc. soon.

## CARE OF INDICATING METERS

**Handling.**—The movement of an electrical indicating instrument is supported between steel pivots whose points have a radius of about 0.001". These pivots bear on polished jewel bearings. In order to avoid damage to the movement it is important to avoid rough handling, so:—

(1) Carry instruments carefully and hold them by carrying handles, if provided.

(2) When placing a meter on a bench cultivate the habit of easing it down with your finger tips, and so avoid the possibility of unnecessary bumps.

**Cleanliness.**—The moving parts of a sensitive electrical instrument work with fine clearances; to ensure reliable operation the instrument should be kept clean. So:—

(1) If your multi-meter is provided with a carrying case, return it to the case and close the lid when instrument is not in use.

(2) If it is necessary to open the case enclosing the indicating mechanism cleanliness is very important. A layer of dust will soon settle on those fine air gaps, and sticky operation will result. Be especially careful to keep away from iron filings when opening the case of a moving coil instrument, as these will be attracted by the magnet and will stand on end in the air gaps, completely blocking the motion of movement.

**Accuracy.**—When it is necessary to get that last bit of accuracy for a particularly critical measurement, here are some of the points you should keep in mind:—

(1) Portable instruments are usually calibrated laying flat on a horizontal bench. Due to the effect of a small amount of unbalance of the movement, tilting the instrument will introduce small errors into the indication, even if the pointer is re-adjusted to zero by the zero adjuster.

(2) Moving coil instruments are affected by masses of magnetic material in their immediate proximity. The sensitivity of a flush panel type instrument is reduced 3 to 5% when mounted in a close fitting steel panel. Don't put a portable instrument on a steel bench or on other equipment mounted in steel cases. Avoid placing meters together under working conditions, as the magnetic fields can interact with each other and cause inaccurate readings.

(3) The rated accuracy of an indicating meter is usually expressed as a percentage of the full scale reading. Therefore the maximum possible percentage error in a given reading increases as the reading is reduced from the full scale value. Conversely, for maximum inaccuracy it is desirable as a general rule, that readings be taken as near to full scale as possible. One exception to this rule is to be observed when using the ohmmeter. With the common types of ohmmeter used for radio servicing

work, the reading of the ohmmeter is zero at one end of the scale and infinity at the other; for greatest accuracy readings should be taken at the CENTRE of the scale.

The above information was prepared by Duncan Gray (VK3ADG) who is leader of the "Laboratory and Calibration Group." If you have any special problems regarding instruments which you would like to see explained in "Amateur Radio," then drop a line to Duncan care of the Technical Advisory Committee of the W.I.A. (Victorian Division).

## Optical Plastics to Revolutionise Television Receivers

### Description of New System

Details of new plastic optical systems, which will revolutionise the design and performance of domestic television receivers, was described at a meeting of the Television Society in London on Thursday, 29th May.

The new systems, which have been evolved in the Optical Development Department of I.C.I. Plastics Division, at Welwyn, will render obsolete the present-day small curved screen, round which viewers are obliged to huddle in order to get an undistorted picture. In its place will be a large flat screen—approximately 16" by 13"—providing a well-lit picture of great clarity to a much larger audience.

The heart of the television receiver is, of course, the cathode ray tube. It is in television what the loud-speaker is in a sound system—the instrument by which the electrical impulses collected on the aerial are converted into something tangible.

With the design of television receiver at present in use, the viewing screen is, in fact, the curved end of the cathode ray tube. There are, however, definite limits to the size of the tube that can be employed and therefore to the size of the picture obtainable by this system. The type normally used is of 9" diameter, giving an image 7½" by 6" on its end, but the provision of a large picture by this system would demand a cathode ray tube so big that its incorporation in a domestic set would be physically impossible. For example, a picture large enough for comfortable viewing would demand a cathode ray tube two feet in diameter and very much longer.

The obvious solution has been to develop an optical system with large light-gathering power, so as to make the utmost use of the already weak picture on the cathode ray tube. Such a system has been available for some time. Consisting of a concave mirror plus a corrector plate of complex shape with a non-spherical surface to ensure absolute accuracy, it had been used for some years in astronomical work. In the I.C.I. laboratories this has now been adapted to television projection, and the

factor which has hitherto prohibited its widespread use—the enormous cost of the lenses and mirrors when made in glass—has been completely overcome by the perfection of a rapid and cheap method of casting accurate lenses in transparent plastics, known as "Transpex" I and II. The extreme accuracy demanded of a lens of this nature has been obtained by building up on their surfaces a skin of the same material until they constitute a perfect reproduction of the mould. This unique process, known as Surface Finishing, has paved the way to the widespread utilisation of such systems, and their mass production at a very moderate price for installing in domestic television receivers. Eventually, the bigger screen will not necessitate any increase in the price of receivers—if anything, the reverse. Moreover, the optical system is so compact that it will enable combined television and sound receivers to be produced in cabinets of quite moderate size.

The new plastic system reproduces pictures without any foreshortening or reflection of highlights in a room, which are ineradicable faults of the curved screen. Coloured pictures are reproduced with great fidelity.

Another interesting development is called a directional screen. This concentrates all light in the normal viewing area of the projected picture, enabling a large number of people in the normal living room to see it equally brightly, whatever their position with respect to the receiver. These screens, which are still in the experimental stage, are covered with tiny plastic lenses so minute that 40,000 are contained in the square inch.

Mass production of plastic optical systems by the Surface Finishing process will begin before the end of the year, and be in full swing by the middle of 1948. The necessary factory will be established in the London area.

## FOR SALE, EXCHANGE, WANTED

9d. per line, minimum 2/-

**WANTED TO BUY.**—QSTs for Sept., Oct., Nov. and Dec. 1940, and Jan. 1946—in good condition—fair price paid. VK3UM, W. Mitchell, 1946 Malvern Road, East Malvern, or ring MLXY 440, Ext. 6635, during day.

**WANTED TO BUY.**—Good 4 or 5 tube a.c. or battery receiver, must cover 80, 40, 20 with 10 optional, will pay freight. Eric Trebilcock, Box 12, Wynyard, Tasmania.

VK3SK wishes to dispose of quite a bit of transmitting gear, a tube checker, and communication receiver. Please telephone LF 7092 for information.

## TYPE 807 AS A HIGH-MU TRIODE

Not Recommended, says A.W.V.

We were recently approached for an opinion on the performance of a type 807 as a high- $\mu$  triode with control grid and screen tied together. Tests carried out on a few valves gave the following results at a plate current of 25 Ma.:

Amplification factor	.....	195
Mutual conductance	.....	4,500 umhos
Plate resistance	.....	43,000 ohms.
The plate current at zero bias was approximately as under:—		
Plate Voltage		Plate Current
200 volts	.....	1.9 Ma.
300	.....	2.9
400	.....	3.7
500	.....	4.8
600	.....	5.6
700	.....	6.7

The tests at positive grid voltage were very disappointing, owing to the heavy grid current. It can therefore be taken that type 807 as a high- $\mu$  triode, is not suitable for use as a zero-bias Class B Amplifier. It may, possibly, find a limited application as a high-gain resistance coupled amplifier operating in the negative-grid region.—Radiotronics No. 125.

## Selection of Valves For Use As Cathode Followers

Not all types of valves are entirely satisfactory as cathode followers, or even with an unbypassed cathode bias resistor. No trouble usually occurs with triodes, but care should be taken to see that a pentode should have the internal screen, if any, connected to some pin other than the cathode pin. It is important that the internal screen be effectively earthed and this cannot be done with a cathode follower if the screen is connected to the cathode inside the valve.

This is the case with types 6AG5 and 6AK5, so that neither of these types is desirable for use as a cathode follower. Types 6AU6 and 6BA6 are entirely satisfactory for use as cathode followers, since their internal screens are connected to the suppressor grid and not to the cathode. In this case the pin leading to the suppressor grid and internal shield should be returned to a point of approximately the same d.c. voltage as that of the cathode, but should be adequately bypassed to earth.

Radiotron types 6U7G and 6D5 differ from valves of the same type numbers by other manufacturers in that the internal screen is connected to pin number 5 (suppressor) as indicated on the A.W.V. data sheets. This is specially to permit the use of these valve types in certain equipment in which the cathode is not earthed.

Radio engineers are advised to pay careful attention to the connection of the valve internal screen in all cases in which the cathode is not effectively earthed.—Radiotronics, No. 124.



## Why 'drift about' looking for **RADIO PARTS**



Maybe, there'll come a time when you'll be needing urgent replacements or a special addition to that transmitting unit or receiving set. It's then that you remember

# LAWRENCE HANSON FOR **RADIO PARTS**

For many years L. & H. have been the regular radio suppliers to hundreds of amateur radio enthusiasts all over Australia.

The experienced 'ham' knows that the L. & H. components are the most efficient, the most reliable **AND THE MOST COMPREHENSIVE RANGE OF RADIO PARTS PROCURABLE ANYWHERE.**

If L. & H. can't supply those hard-to-get components, it is because they are simply **NOT** procurable. L. & H. components are guaranteed for years of quality service.

### CHECK THIS LIST OF PARTS RIGHT NOW !

MICROPHONES  
COILS  
BATTERIES  
METERS

SWITCHES  
VALVES  
VIBRATORS  
TRANSFORMERS

CHOKES  
CHASSES  
CONDENSERS  
SPEAKERS

RESISTORS  
LINEFILTERS  
Etc., Etc.

**TECHNICAL ADVICE GIVEN ON REQUEST.**

Obtain latest lists and prices from your radio house.

## LAWRENCE & HANSON ELECTRICAL PTY. LTD.

33 YORK STREET, SYDNEY  
120 COLLINS STREET, HOBART  
87 ELIZABETH STREET, BRISBANE

172 WILLIAM STREET, MELBOURNE  
60 WAYMOUTH STREET, ADELAIDE  
20 LAWSON STREET, LAUNCESTON

# Modern Miniatures

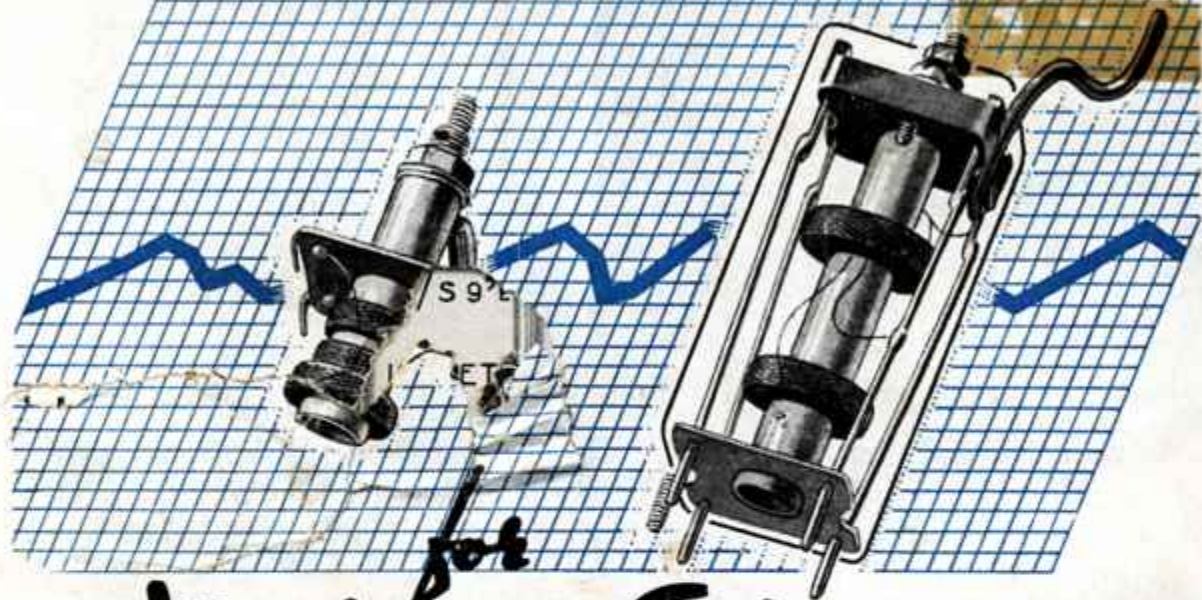

## for Maximum Efficiency

Save space in your set but never needlessly sacrifice efficiency! AEGIS present these popular versions of the smaller components — they're compact, yet they are big enough to avoid the troubles to which many midget parts are unavoidably subject.

### COILS

Illustrated actual size above is the new AEGIS Coil . . . of the unshidied variety, permeability tuned and having one-hole mounting ideal for under chassis fitting. These new Coils are Type M1 Aerial, M6 R.F., and M7 Oscillator. Retail price, each.

6/9

### I/F S

The new AEGIS releases are only 2 1/2" x 1 1/2" square (exact size as illustrated above). Scientifically designed to give optimum gain, these I.F.'s are particularly suitable for high fidelity receivers where maximum high frequency response is required and special features include Trolital Lo-Loss Trimmer Base and windings carefully treated and impregnated in special Lo-Loss Trolital. Type J1 is Interstage and Type J2 Diode. Retail price for both, each.

10/6

# AEGIS

MANUFACTURING COMPANY

208 LT. LONSDALE ST.,  
MELBOURNE, VIC.

Attractive Net Prices  
For Trade  
and Amateurs

#### VICTORIA :

Replacement Parts Pty. Ltd.  
Lawrence & Hanson Elec. Pty. Ltd.

J. H. Magrath & Co.  
John Martin Rodd & Elec. Pty. Ltd.

#### DISTRIBUTORS IN

Brown  
Green Martin Pty. Ltd.

#### ALL STATES

QUEENSLAND:  
Chandler's Pty. Ltd.  
W.A. :  
Nicholson's Ltd.  
Atkins (W.A.) Ltd.

#### S.A. :

Healings Ltd.  
Harris, Scarfe Ltd.  
Newton, McLaren Ltd.

#### TAS. :

Le Rossignol Pty. Ltd., Hobart  
Lawrence & Hanson Elec. Pty. Ltd., Launceston.

# AMATEUR RADIO

OCTOBER  
1947

JOURNAL OF THE WIRELESS INSTITUTE OF AUSTRALIA



## PHILIPS

*Famous for* TRANSMITTERS • TRANSMITTING  
COMPONENTS • TRANSMITTING  
TRIODES, TETRODES AND PENTODES • HIGH VACUUM  
AND MERCURY VAPOUR RECTIFIERS.



PHILIPS ELECTRICAL INDUSTRIES OF AUSTRALIA PTY. LTD.  
SYDNEY • MELBOURNE • ADELAIDE • PERTH • BRISBANE

G-21-43



FOR THE EXPERIMENTER & RADIO ENTHUSIAST

Registered at G.P.O., Melbourne, for transmission by post as a periodical.

6d.

# *Kingsley again with something NEW!*

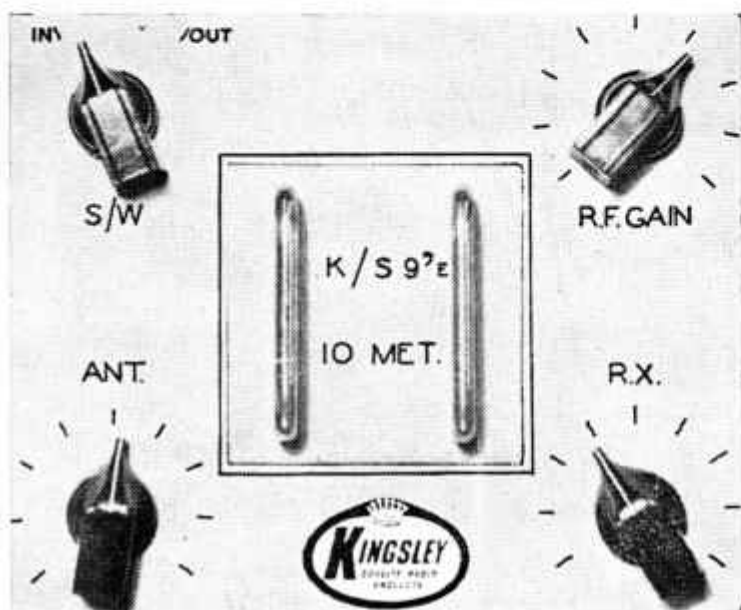

Typical of Kingsley's progressive post-war programme, is this outstanding signal-strengthening unit. Kingsley's forward vision in radio has produced some of the most outstanding advancements in Australian Radio, and will continue to do so. For the very best in radio equipment — keep your eyes on Kingsley.

**The 'KS' 9'er.** This unit is designed to bring weak signals to the 9 level. The circuit consists of a system permitting matching to the antenna and to the receiver . . . this match is adjustable. Two inductances for each band are tuned with Iron Cores. A worth-while addition to the 'Ham' Station . . . designed with two coil boxes—one for 10 Metre operation and one for 6 Metre. May be ordered either with or without Coil Boxes.

**ORDER FROM ANY KINGSLEY DISTRIBUTOR.**



## **KINGSLEY RADIO**

**KINGSLEY RADIO PTY. LTD.**

**380 St. Kilda Road, Melbourne, Victoria . Phones: MX 1159, MX 3653**

# AMATEUR RADIO

*Published by The Wireless Institute of Australia,  
Law Court Chambers, 191 Queen Street,  
Melbourne, C.I*

**Editor:**

T. D. HOGAN, VK3HX.  
Telephone: UM 1732.

**Technical Editor:**

J. K. RIDGWAY, VK3CR.

**Notes Editor:**

R. W. HIGGINBOTHAM, VK3RN.

**Distribution:**

H. N. STEVENS, VK3JO.

**Business Manager:**

J. G. MARSLAND, VK3NY.

**Advertising Representative:**

W. J. LEWIS,  
20 Queen Street, Melbourne, C.I.  
Telephone: MU 5154.

**Printers:**

H. HEARNE & CO. PTY. LTD.,  
285 Latrobe Street, Melbourne.

MSS. and Magazine Correspondence should be forwarded to the Editor, "Amateur Radio," Box 2611W, G.P.O., Melbourne, on or before the 15th of each month.

Subscription rate is 6/- per annum, in advance (post. paid).

— IN THIS ISSUE —

The Crystal Filter . . . . .	3
A Wide Range Crystal Filter for 455 Kc. . . . .	6
Correspondence . . . . .	8
Fifty and Up . . . . .	9
Federal QSL Bureau . . . . .	12
Such Nice People . . . . .	12
Federal Notes . . . . .	14
Divisional Notes . . . . .	16

## EDITORIAL



The Editorial for September advised you that your Federal Executive was seeking definitions of British and American standards covering frequency modulation technique. Information received from A.R.R.L. Headquarters indicates that two sets of standards are being adopted in U.S.A., namely:—

- (1) Use of all types of frequency modulation, including wide band, on the following bands: industrial heating or diathermy band 29-29.7 Mc., 52.5-54 Mc. all bands above 144 Mc.
- (2) Use of narrow band frequency modulation for one year's test on 3850-3900, 14200-14250 and 28500-29000 Kc. bands.

It is interesting to note that Federal Communications Commission (U.S.A.) has defined narrow band frequency modulation as a "system of frequency modulation where the peak deviation is limited to a value equal to or less than the maximum modulation frequency." In other words, the band width must not exceed that occupied by an amplitude modulated sig-

nal of the same audio characteristics.

Federal Executive recommends adoption by Australian Amateurs of the following standard:

- Maximum modulation frequency: 3500 cycles.
- Peak deviation:  $\pm$  5000 cycles.

Insofar as Pulse Technique is concerned, the setting up of standards must be deferred until such time as privileges are extended to pulse modulation. The only requirement for pulse transmission, for which stations are at present licenced, is that the combination of pulse length and repetition frequency selected should be such that "average power" does not exceed licenced value.

Once more those who intend to make use of these new types of transmission are advised to be cautious in their choice of technical equipment and methods. Consider carefully all the factors involved before plunging haphazardly along the wrong road. A little thought will pay big dividends.

G.G.



# LARGEST STOCKS IN AUSTRALIA

at *Homecrafts* PTY. LTD.

## Compare Our Prices!

★ English Cosmocord  
**PICKUPS 67/9**  
 CRYSTAL

★ Cosmocord Re-  
 placement  
**CRYSTAL 31/-**  
 CARTRIDGES

★ Air Force Quality  
**CO-AXIAL 3/11**  
 CABLE

★ 5" CATHODE RAY TUBES,  
 Type VCR112 Normal Price  
 £12. Our Price ... **30/-**  
 Plus Sales Tax.

★ 100 Watt Medium Duty  
**SOLDERING IRONS 22/6**

★ Write for CIRCUIT Blueprint of  
 Homecraft 5" Cathode Ray  
 Oscillograph **1/6**  
 Plus Postage

★ NEW MIDGET VALVES  
 Available for immediate de-  
 livery from stock!  
 3Q4 1L4 1S4  
 3S4 1T4 1B5  
 Prices on application.

★ 50 ft. Coils Insulated AERIAL  
 Wire . . . . . **1/3** Per Coil

★ 78 RPM Synchronous type  
 ELECTRIC  
 GRAMAPHONE **£7/15**  
 MOTORS . . . . .  
 Plus freight

★ 2 Volt 100 amps **27/10**  
 ACCUMULATORS

★ GRAEME  
 4 valve Reflex Super Het KIT-  
 SETS including Bakelite Cabi-  
 net, Valves and Speaker . . . .

### 13 Guineas

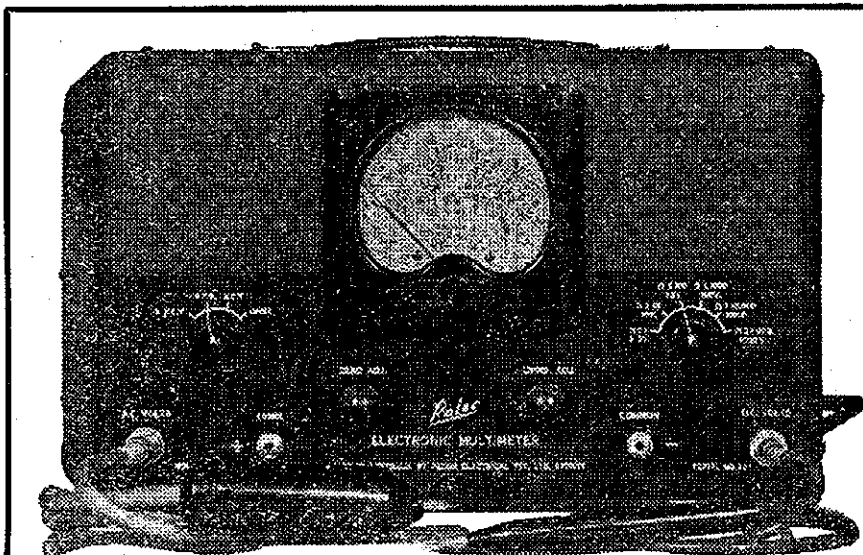

NOW AVAILABLE FOR IMMEDIATE DELIVERY—  
**PALECTRONIC V.T. (Probe) MULTIMETER**  
 MODEL V.T.M.

Every Amateur will find this the most useful instrument yet devised.  
 WRITE US FOR FULL PARTICULARS. This is a Winner! and only

### £29/10/- - - Plus Tax

**HOME CRAFTS** PTY. LTD. The Radio & Electrical Specialists

Head Office . . . . . MELBOURNE, 290 Lonsdale Street, and at—  
 211 Swanston Street, Melbourne. 307 Sturt Street, Ballarat. 139 Moorabool Street, Geelong. 121 Pirie Street, ADELAIDE.  
 100 Clarence Street, SYDNEY. 26 Hunter Street, Newcastle. Hobart, Launceston and Burnie, TASMANIA.

# THE CRYSTAL FILTER

By G. W. NEILSON\*

The development of the Quartz Crystal Resonator can be regarded as one of the milestones of Radio in general and of Amateur Radio in particular. The Quartz Crystal has many uses, not the least of which is the use as a frequency controlling device in Radio Transmitters. But perhaps its most remarkable attribute to Radio has been its development as a control of the selectivity of a Radio Receiver.

It was first suggested for this work by an Englishman by the name of Dr. Robinson but due credit must go to the American Lamb who was responsible for the first practical design of a Crystal Filter. Since Lamb's work, the Filter has gone through much developmental work and today is a device readily usable on phone as well as c.w. in contrast to the old Filters which were satisfactory on c.w. only due to their inability to supply selectivity variations to suit both types of reception.

## PRINCIPLE OF OPERATION

The Quartz Crystal can be represented electrically by the approximation shown in Fig. 1 as an inductance, capacitance and resistance in series shunted by an additional capacitance. The series element corresponds to the equivalent series resonance of the crystal, in other words the frequency at which it oscillates, the resistance corresponding to the losses caused by inertia, friction, etc., and of course governs the equivalent Q of the crystal. The shunt element corresponds to the capacity of the crystal holder and any other stray capacity which might be shunted across the crystal. Typical values for a 455 Kc. crystal as shown in Fig. 1 are: L1 7 henries, C1 0.02 mmfd., C2 10 mmfd., R1 3,000 ohms, which is equivalent to a Q of 7,000 approx. It will be observed that the reactance values are considerably different to those normally associated with frequencies of 455 Kc.

It is now necessary to arrange this somewhat complex and unusual resonant device in a circuit that will control the selectivity of a receiver. As the crystal is fundamentally a series resonant device it is invariably used as a selective coupler between two circuits—usually tuned. This is shown in Fig. 2. For the present the shunt capacity has been neglected and will be dealt with later. In the equivalent circuit it can be seen that it can be regarded as three impedances in series consisting of the input impedance, the crystal impedance and the output impedance. The input

\*34 Andrew Street, Northcote.

and output impedances will be dependent on the circuit arrangement and whether tuned or untuned. Over a range of about 10 Kc. on either side of resonance these impedances will only vary over about a 2 to 1 range, assuming reasonable Q. On the other hand the crystal impedance increases considerably off resonance. Calculated values are shown in Table 1—assuming constant crystal Q.

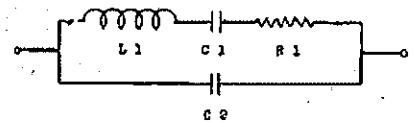
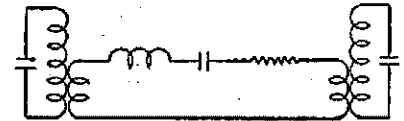
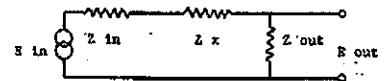

FIG. 1. EQUIVALENT CRYSTAL CIRCUIT



BASIC CRYSTAL FILTER CIRCUIT



EQUIVALENT ELECTRICAL CIRCUIT

FIG. 2.

TABLE 1

Frequency Resonance	Crystal Z 3,000 ohms	Output attenuation for various output Z			
		250,000 0.2 db	50,000 0.8 db	15,000 2.5 db	5,000 ohms 6.0 db
0.125 Kc. off	10,000 "	0.4 "	1.9 "	5.1 "	10.6 "
0.25 " "	20,000 "	0.7 "	3.2 "	7.8 "	14.6 "
0.5 " "	40,000 "	1.4 "	5.3 "	11.6 "	19.5 "
1.0 " "	80,000 "	2.5 "	9.0 "	16.0 "	25.0 "
2.0 " "	160,000 "	5.0 "	14.0 "	21.0 "	31.0 "
4.0 " "	320,000 "	10.0 "	19.0 "	27.0 "	36.0 "
8.0 " "	640,000 "	18.0 "	26.0 "	33.0 "	42.0 "

It can be seen that the output voltage can be calculated from the equation:—

$$E_{out} = \frac{Z_{out}}{Z_{out} + Z_{in} + Z_x} E_{in} \quad (1)$$

At resonance when  $Z_{in}$  plus  $Z_x$  is small  $Z_{out}$  can be varied over at least a 50 to 1 range with very little effect on the output voltage, when  $Z_{out}$  is equal to  $Z_{in}$  plus  $Z_x$  the output voltage is reduced to half or in other words 6 db. This is usually considered the maximum permissible. By varying this output impedance the selectivity of the filter can be controlled. If in Fig. 2 the input impedance is given a value of 2,000 ohms and the output impedance is varied over four steps of 250,000 ohms, 50,000 ohms, 15,000 ohms and 5,000 ohms the attenuation in db obtained at the frequencies shown in Table 1 is given.

This is the principle of the most popular filter of the present day. The input impedance consists of a low impedance secondary, which is untuned, coupled to a tuned primary, while the output impedance is a high impedance tuned coil. This high impedance is obtained by using reasonably high Q—about 70 to 100—and fairly low tuning capacity—about 70 to 100 mmfd. This output impedance is varied by switching

resistance in series with the coil, shunting resistance across the coil or detuning the coil. As the resistance in series with the coil is increased the Q is reduced, so lowering the impedance of the tuned circuit. Similarly as resistance is shunted across the coil the impedance is reduced. Thirdly, of course, the impedance of a tuned circuit is maximum when tuned to resonance. In early crystal filters the selectivity was controlled by varying the input impedance. The input coil was usually an i.f. transformer with tuned secondary and detuning this secondary controlled the selectivity. The main disadvantage of this type was the fact that as the secondary was detuned the voltage applied to the crystal was also reduced and quite often resulted in a serious loss in output.

## THE PHASING CONDENSER

The effects of the shunt capacity of the crystal must now be considered. Re-drawing the equivalent circuit it can be seen that the effect of the shunt capacity is to give a parallel resonant circuit instead of the usual series resonant, see Fig. 3. The frequency of parallel resonance is slightly higher than that of series resonance due to the two capacities being in series, the resultant capacity being slightly smaller—C2 is usually

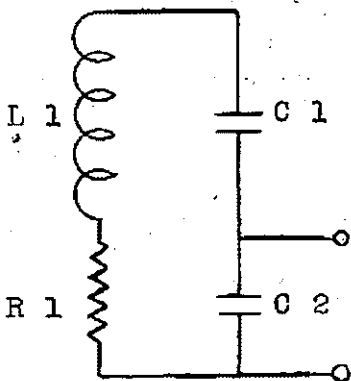

Fig 5—Equivalent Electrical Circuit, showing Parallel Resonant Effect

large in relation to  $C_1$ . Now while the impedance of a series resonant circuit is lowest at resonance the impedance of a parallel resonant circuit is highest at resonance. The parallel impedance of the total circuit may be many thousands of megohms:—

$$Z_{pnt} = 6.28 \times f \times L \times Q \dots (2)$$

and the impedance actually across the crystal will be some small percentage of this due to the voltage divider effect of the two capacities in series:—

$$Z_{x\text{ pnt}} = \left\{ \frac{C_1}{C_1 + C_2} \right\}^2 \times Z_{pnt} \dots (3)$$

The parallel impedance across the crystal can quite easily be 500,000 ohms or more. Thus a sharp dip will appear in the selectivity curve at the frequency of parallel resonance of the crystal. While the presence of shunt capacity causes an increase in attenuation on the high frequency side of series resonance, it also causes a corresponding reduction in attenuation on the other side.

By now arranging a capacitive bridge circuit the shunt capacity can be effectively neutralised. This is shown in Fig. 4. The balancing voltage is obtained by splitting the input circuit and coupling the out-of-phase voltage through an adjustable phasing condenser to the output of the crystal. By appropriate adjustment of this condenser the shunt capacity of the crystal is phased out and its effect eliminated. If the input circuit is centre-tapped  $C_5$  will equal  $C_2$  for balance. Now if  $C_5$ , which should be, say 10 mmfd. to balance out  $C_2$ , is only 9 mmfd., this is equivalent to having 1 mmfd. still in shunt with the crystal. This will mean that the frequency of parallel resonance will now be further away from the crystal frequency due to the capacity which is in series with the crystal resonant circuit being much smaller. If  $C_5$  is increased to 11 mmfd. this results in a residual inductance in shunt with the crystal. This gives an equivalent circuit shown in Fig. 5 and the parallel resonant frequency is now lower than the crystal frequency.

This effect can be explained by representing the 10 mmfd. capacity  $C_2$  as an 11 mmfd. capacity in parallel with a 1 mH. inductance. The inductive reactance cancels out portion of the capacitive reactance giving the resultant 10 mmfd. The 11 mmfd. capacity is phased out with the phasing condenser so that the 1 mH. inductance is left in shunt with the crystal.

So by adjusting the phasing condenser on each side of the balance point, it is possible to cause a rejection dip to appear on either side of the crystal frequency at the expense of loss of selectivity on the other side. It is well to note that the closer the rejection dip is required to the crystal frequency the further the phasing condenser must be adjusted away from the balance point, the limit being governed by the maximum and minimum capacity of the phasing condenser and the capacity across the crystal. Increasing  $C_2$  and  $C_5$  accordingly will enable the rejection dip to be brought closer to the crystal frequency.

$C_5$  is usually designed to balance when set at half scale and to have an equal amount of capacity change on either side. In some cases a trimmer is connected across the condenser which is first set at half scale and then the trimmer is adjusted to give balance. The capacity of the trimmer should be kept as small as possible as it limits the amount of capacity change of the phasing condenser.

Study of Fig. 4 will show that  $C_5$  is effectively in parallel with the output coil as one side of  $C_5$  is only a few thousand ohms above ground. Thus any change in the capacity of  $C_5$  will detune the output coil which is not desirable. This is usually overcome by using a differential condenser for  $C_5$ . This condenser has two sets of stator plates so arranged that the capacity of one increases as the other decreases. The other set of stator plates are earthed so that the total capacity across the output coil remains constant.

The complete filter is shown in Fig. 6. It should be remembered that the input capacity of the following tube is also across the output coil if connected right across it, and "Miller Effect" capacity changes and possible regenerative effects in the tube can upset the operation of the filter. Thus the tube must be carefully operated to prevent these effects and one effective way is to tap down the coil. When operated after a standard i.f. tube, these filters will give a stage gain of about 10 and it is good practice to reduce this gain to about unity by tapping down the output coil and operating the filter purely for that purpose and not to supply any stage gain.

#### ALIGNMENT PROCEDURE

This alignment procedure deals more or less with the variable sel-

activity filter as described above, but can be adapted to suit other types by studying the inherent circuit and applying the principles outlined. The secret in alignment of these Crystal Filters is in the use of the correct type of indicating equipment and if possible some form of vernier control of the tuning of the receiver or the test oscillator used. If not oscillator is available it will be necessary to rely on a steady carrier, preferably unmodulated. The necessity of a fine tuning is indicated by the extreme selectivity obtainable from these filters as this complicates the tuning of the signal and the indication of maximum gain.

The normal method of using a modulated signal from the test oscillator is not satisfactory as the selectivity is quite often sufficient to completely remove the modulation from the carrier on resonance and so resonance does not give maximum output.

The indicating device used must therefore be capable of indicating carrier level and not audio level. This can be an S Meter—the most convenient type of indicating device—a microammeter in the detector diode load, a magic-eye or some other form of carrier level indicator that would suit the individual receiver and operator.

Some form of fine tuning on either the receiver or test oscillator is also very desirable. Electrical bandsread will greatly facilitate this and if the receiver can be arranged to cover the broadcast band one very satisfactory method is to feed the test oscillator into the mixer tube at about 600 Kc. and then if the band spread condenser is about 15 mmfd., this will enable an exceedingly fine tuning control of the frequency. The test oscillator can be left fixed and all the tuning done with the receiver. In a set-up used like this,  $\frac{1}{4}$ " of dial travel was equivalent to 150 cycles per second change in frequency. When it is remembered that bandwidths of 100 cycles or less are easily obtainable, some form of fine tuning is desirable. It should be realised also that any receiver which incorporates a Crystal Filter should have an exceptionally good tuning mechanism and excellent frequency stability.

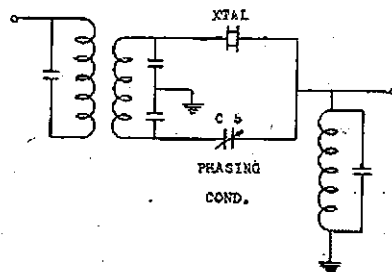

Fig 4—Crystal Filter Circuit, showing Method of Phasing Out Shunt Capacity

The actual procedure of alignment for a Crystal Filter now becomes:—

1. Switch Filter to **Minimum Bandwidth** (sharpest position).

2. Adjust the test oscillator or tuning device for indication on carrier meter. This should show a peak of an exceedingly sharp nature with possibly a rejection dip and another smaller peak fairly close. Note the frequency of maximum signal, this corresponds to the crystal frequency and is usually characterised by the typical crystal "ring."

3. Detune about 5 Kc. to one side of this frequency.

4. Adjust the **Phasing Control** for a rejection dip, increasing the oscillator input if necessary. If the Phasing Condenser has a trimmer across it, it may be necessary to adjust this trimmer to bring the rejection dip within the range of the Phasing Control. Note the position of the rejection dip on the Phasing Control.

5. Detune 5 Kc. on the other side of the crystal frequency.

6. Adjust the **Phasing Control** for another rejection dip. Note the position of this dip also.

7. The correct **Phasing Control** position should be approximately half way between these two points. This position should correspond to the centre position of the Phasing Condenser and if a long way out, due adjustment should be made to the capacity range of this condenser to bring it correct.

8. If there is a trimmer across the Phasing Condenser this should be adjusted to bring the correct position to the centre of the Phasing Control.

9. Retune for maximum indication as in 2.

10. Switch Crystal Out. This is very important at this stage.

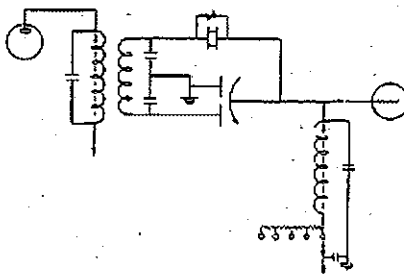

Fig 6—Complete Crystal Filter

11. Adjust all tuning circuits in the i.f. channel for maximum signal, including the **Crystal Input Coil** but excluding the **Crystal Output Coil**. The frequency which gives maximum signal with the Crystal in the **minimum bandwidth** position should also give maximum signal in the **Crystal Out** position. Any discrepancies will indicate either faulty alignment of the i.f. channel, unstable circuit arrangement or unsatisfactory i.f. transformers. This adjustment should be carried out at the weakest signal level possible in case the i.f.s. are susceptible to "Miller Effect" detuning.

12. Switch the Crystal to **Maximum bandwidth** (broadest position Crystal In).

13. Tune in a station preferably a broadcast station with music modulation.

14. Adjust the **Crystal Output Coil** for minimum distortion and minimum side-band cutting. This is due to the correct adjustment of this coil giving maximum bandwidth and so maximum high note response. Adjustment of this coil should have practically no effect on the carrier level. Any marked change in this level will indicate incorrect tuning of the signal and/or incorrect adjustment of the Phasing Condenser. Retune with the Crystal in the **minimum bandwidth** position and then switch to the **maximum bandwidth** position and recheck the adjustment of the **Crystal Output Coll.**

15. Switch Crystal to **minimum bandwidth**.

16. Tune for maximum signal as in 2.

17. Switch Crystal to **maximum bandwidth Crystal In**.

18. If it is necessary to retune for maximum signal level the **Crystal Output Coll** is not adjusted quite correctly and slight alteration to this will enable the point of maximum signal in the maximum bandwidth position to correspond with the point of maximum signal in the minimum bandwidth position.

19. Switch Crystal to **minimum bandwidth**.

20. If the b.f.o. is now switched on

it should beat with the receiver noise—do not feed in any signal—and adjustment of the b.f.o. Note **Control** should give a zero beat with this noise. Adjust the b.f.o. until this zero beat comes in centre of the b.f.o. Note **Control**. Adjustment of the **Phasing Control** on either side of the correct phasing position should cause a rise in noise level; the point of minimum noise corresponding to the correct position.

## Australia's Largest Stock of All Radio Components

- Chokes
- Coils
- Condensers
- Dials
- Intermediate Transformers
- Mose Equipment
- Potentiometers
- etc., etc.
- Resistors
- Soldering Irons
- Speakers
- Test Equipment
- Valves
- Pick-Ups
- Power Transformers
- etc., etc.

Obtainable from

### Bloch & Gerber Ltd.

with which is associated  
the

### WELDON ELECTRIC SUPPLY CO.

46-48 YORK STREET,  
SYDNEY

G.P.O. Box 2282 M

Phones: MA 6291 (10 lines)

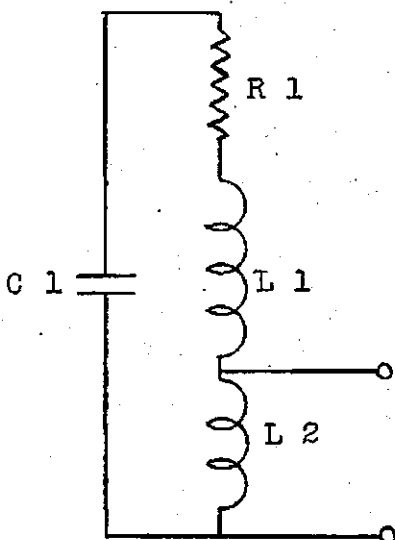

Fig 5—Equivalent Electrical Circuit, showing Parallel Resonant Effect. Phasing Condenser Too Large

# A WIDE RANGE CRYSTAL FILTER FOR 455 Kc.

By J. BROWN, VK7BJ\*

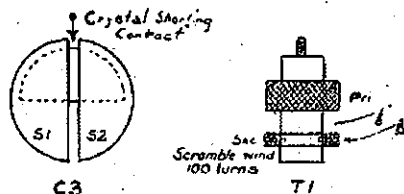

FIG 2

In these days of congested bands an efficient Crystal Filter is a vital necessity if QRM is not to spoil the majority of QSOs. The Filter to be described has adjustable rejector control which will eliminate a heterodyne too close for the selectivity of the filter to reduce, and a variable selectivity control.

In the sharp position the selectivity is truly single signal and will remove the modulation from a phone signal. In the broad position the selectivity, whilst still much sharper than the conventional three i.f. transformer arrangement, is wide enough to allow good speech intelligibility and cleans up phone reception considerably. Thus there is no need to switch the filter out of circuit and it may be left in all the time, although provision has been made for switching it out, if desired. Listening tests on 14 Mc. c.w. prove that a signal which cannot be identified in the mess may be Q5 with the filter in.

As the filter causes a fair loss of gain it is more suitable for those receivers having an r.f. and two i.f. stages, but is also useful on smaller receivers, as an R5 signal with little QRM is more readable than a R9 one buried in QRM from other R9 stations. The crystal frequency chosen was 455 Kc., as filters at this frequency are much simpler to get going than they would be at 1900 Kc. As I prefer a 1900 Kc. channel, to avoid images and pulling, the particular set that this filter was used in is a double conversion job but this does not effect the filter operation in any way.

## CIRCUIT DETAILS—ELECTRICAL

The circuit is as shown in Fig. 1. As some of the parts were not readily available they had to be made up and these will be described as we go along. Firstly, the input transformer T1 has a conventional tuned primary but a low impedance untuned secondary. This transformer is made by cutting a conventional i.f. transformer in two halves close to the bottom winding which is then removed complete and placed to one side for use as T2. Then a winding of about a 100 turns (not critical) is wound underneath the top half of the original transformer and spaced an 1/8" from it. The coil should be wound between two insulating washers, the wire gauge (about 30 S.E.) and width of winding should be chosen so that the new secondary coil

has a diameter approximately equal to the primary coil. An i.f. transformer should be chosen in which the iron trimming slug does not project below the top winding when aligned to 455 Kc. The addition of the two 100 mmfd. condensers C1 and C2, which should be small enough to be mounted inside the can, completes the assembly of T1. These two condensers are merely to provide a centre tapped output to enable the phasing condenser to work

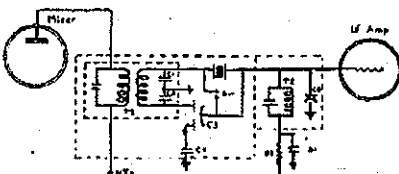

Fig 1

- T1—Input transformer, see text.
- T2—Output transformer, see text.
- C1, C2, C4—100 mmfd. mica.
- C3—Differential phasing condenser, 30 × 30 mmfd., see text.
- C5—Selectivity control, 25 mmfd. midget variable.
- Sw.—Shorting contact on C3 or separate switch.
- Xtal.—455 Kc. crystal.

and should not resonate the secondary to 455 Kc.

From the input transformer we pass on to the crystal phasing circuit. Owing to the fact that the crystal, plus holder, possesses a fair amount of capacity at off resonant frequencies (15 mmfd. in this case), considerable transfer of signal would occur which would mask the selectivity effect of the crystal. To compensate for this we use a neutralising or phasing condenser C3 which feeds another voltage 180° out of phase into the output circuit. When the capacity of this condenser is equal to that of the crystal no transfer, other than that due to the resonant effect of the crystal, will

occur. By slightly unbalancing this phasing circuit an interfering heterodyne may be greatly weakened but, for tuning, the condenser should be set to the balanced position. If the circuit is traced back it will be seen that C3 in series with C2 is across the output transformer T2 and thus variation of C3 would detune this circuit, which is undesirable. To avoid this a differential condenser must be used as shown. This provides another circuit via the second half of C3 to earth via a 100 mmfd. condenser C4. C3 is so arranged that when top half is increasing in capacity, the bottom half is decreasing and vice versa. Therefore the total capacity across T2 will not change and no detuning will occur. C4 is not entirely essential and may be omitted, the second set of fixed plates for C3 then going directly to earth.

Again, a differential phasing condenser was not available but they are easily made. The total capacity required is about 30 mmfd. with three fixed plates in each section and four common movable plates. An ordinary seven plate midget of the old Radiokes type was obtained. The insulating front plate was replaced by a larger piece of bakelite and the condenser re-assembled with another set of three fixed plates added as shown in Fig. 2.

To allow the crystal filter to be switched out, a separate switch across the crystal may be used or else an auxiliary contact mounted on the condenser frame so that it wipes on the moving plates when the phasing section of C3 has reached minimum capacity. The stunt of bending a plate of the phasing condenser so that the condenser itself will be shorted is not suitable. The crystal itself, if not purchased ready mounted, should be mounted in a holder with an air gap of about 0.001". This holder is easily made from a piece of hard rubber, which is ground to the required thickness on a sheet of emery paper and has screwed to each face a plate of brass which has been ground flat on the inside. The brass plates form the electrodes. The air gap can be varied by altering the thickness of the piece of hard rubber.

The output transformer T2 is simply the second half of the original input transformer and needs no al-

\*12 Thirza Street, New Town, Tas.

## SENSATIONAL NEWS FOR HAMS!

### DEBUT OF THE KINGSLEY K/S 9'ER Will REVOLUTIONIZE Your Short Wave Listening!

This new little unit is designed to provide a build up to an Amateur S/W Receiver, or any type of Communications Receiver. It exercises the function of matching the Aerial to the Receiver correctly, and building up the signal level whilst improving the SIGNAL to NOISE ratio.

The Panels are in black finish with white engraving, and the Case has a black crackle finish. (Front Panel illustrated).

In its most complete form, the unit is provided with two sets of coils—but only one set need be purchased, if you so desire.

Call in at Vealls—Swanston Street, or Prahran—and examine the revolutionary KINGSLEY K/S 9'er for yourself!

# VEALLS

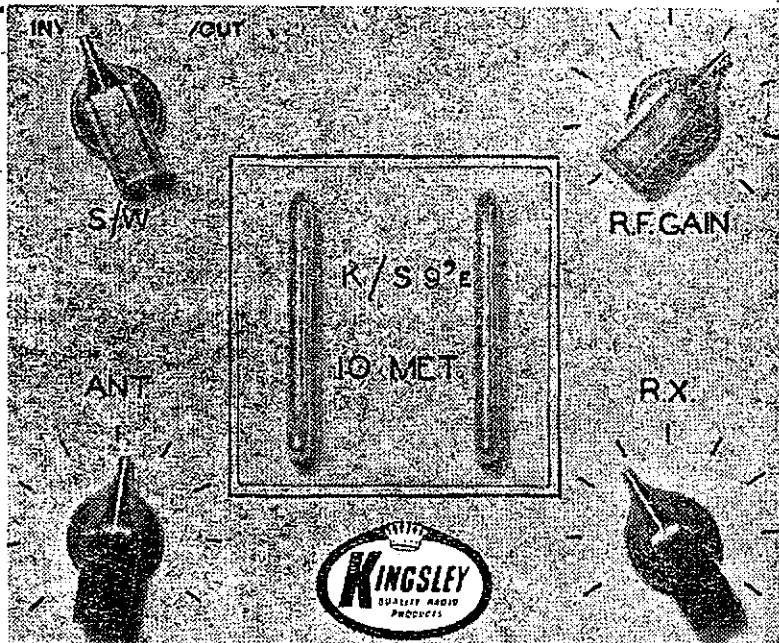

243 Swanston St., Melb. Phone: FJ 3145  
299 Chapel St., Prahran. Phone: LA 1605

teration other than a suitable mounting. The condenser C5, which is approximately 25 mmfd., serves as the selectivity control. When the output circuit is tuned to resonance it puts a large resistance in series with the crystal and so variations in crystal impedance do not have much effect on the voltage developed across T2 and the selectivity will be in its broadest position. When the output circuit is fully detuned it presents a low impedance and the variations in impedance of the crystal become very important and the circuit is now highly selective, intermediate degrees of detuning will give intermediate degrees of selectivity.

As the output circuit is detuned, the loss of the filter decreases at first and so the output of the set increases with increasing selectivity. However, for high degrees of selectivity, output will drop off slightly but does not drop below the crystal off position. It can be seen now why it was important that the phasing control should not effect the tuning of T2 as this would mean that altering the phasing would alter the selectivity. This type of circuit has a much wider variation in selectivity than the type which depends on detuning the input circuit.

#### MECHANICAL DETAILS

The most important thing to watch is that the output circuit should be shielded from any earlier portion of the circuit as any extra signal transfer would nullify the action of the

crystal filter. A shield to cut out the most likely source of stray coupling is shown in the diagram.

The best form of construction if a new set is being built, or sufficient space is available on an old one, is to build the whole filter up in one shield can, which would then simply replace an i.f. transformer. The can should be divided into two by a horizontal shield. The bottom portion should contain the input transformer, which should be individually shielded as well, the crystal and the phasing condenser. The top portion contains the output winding which need not be individually shielded and the selectivity control. The complete unit is mounted in the most convenient position and the control shafts extended to the front panel.

If this form of construction is not possible, the components can be arranged snugly on the chassis in the most convenient positions, but much more care must be taken to shield the output portion of the filter from the input circuit, and the output winding and selectivity control must be shielded. However the arrangement can be fully successful if care is taken in placement and screening. It is best for the input transformer phasing condenser and crystal to be mounted in one spot, but the output transformer and selectivity control may be mounted where most convenient and the connections made with shielded wire, as the capacity (up to a reasonable limit) can be

absorbed by the output circuit tuning. In both cases remember that the shaft of the phasing control is not at earth potential and insulating couplings and mountings must be used.

#### ADJUSTMENT

Tune in a steady signal with the crystal in and adjust the trimmer on T1 for maximum output. Align all other circuits, with the exception of T2, for maximum output. Tune in now to a spot where no signal but plenty of hash is being received and adjust the phasing condenser. When phasing is correct there will be a sharp drop in noise and the remaining noise will be low pitched. This is the setting for correct neutralisation. Mark this position for future reference.

With the circuit properly phased, now set the selectivity control at nearly minimum capacity and mark this for low selectivity. Now adjust the trimmer of T2 until the noise is at its loudest and is high pitched in character. If the selectivity control is now advanced the noise should be greatly reduced and become drummy in character. If the b.f.o. is switched on a ringing sound, due to shock excitation of the crystal, should be apparent, indicating a high degree of selectivity. If the trimmer of T2 has not sufficient adjustment to reach the broadest position, first of all try to reduce the stray capacities across T2 and, if this does not cure it, take some of the turns off the T2 winding.

# CORRESPONDENCE

A good check on stray coupling, which also serves to check the phasing action, is to plug a fixed condenser of 10-15 mmfd. in, in place of the crystal. On adjusting the phasing control a spot should be found where signals completely disappear. If only a dip in signal strength and not a complete cut out is obtained, then stray coupling is taking place and must be eliminated before correct operation of the filter may be expected. If no position is found where a dip occurs, then something is wrong in the phasing circuit. If the directions have been faithfully carried out, this will be extremely unlikely, but check it over just to make sure. A large amount of stray coupling could also cause this trouble and, with a sensitive receiver, it is surprising how little stray coupling will cause a large signal leakage.

Owing to its high selectivity, the crystal filter greatly reduces all noises of the continuous type and the signal stands out of a quiet background, thus then signal/noise ratio is greatly increased. This effect often makes the user think the gain of the set is greatly reduced as the selectivity is increased, but it is the noise only which is reduced and not the signal.

On the other hand impulse noise, such as ignition, is reduced, but not eliminated, and the selectivity of the filter broadens the pulses so that the common forms of noise limiter which follow the second detector are not very satisfactory. The only satisfactory way of eliminating ignition noise with a crystal filter is an i.f. silencer working before the crystal.

Some crystals have spurious responses, but with a good crystal these are unimportant. On tuning a signal in on an S meter, two peaks may sometimes be found. If the crystal is satisfactory, this indicates that the phasing condenser is not set to balance and correct setting of this condenser will eliminate it. Actually this second peak is due to the rejection effect of the out of balance crystal filter causing a wedge of no signal to be inserted in the pass band. This is the effect used for the rejection of an interfering heterodyne.

A lot of users waste so much time in adjusting their filters that the over is finished before the signal is properly tuned in. The way I have found best is to tune with the filter in and already adjusted to an approximate degree of selectivity for the conditions existing at the time, and the phasing condenser set at balance. The signal is then tuned in normally, although care must be taken not to pass over the signal when in the very sharp position. If a heterodyne is annoying it may be eliminated by slightly adjusting the phasing control. The phasing control should be restored before further tuning takes place. I find this method much better than tuning with the crystal out and then switching it in. (Continued on page 24)

Editor, Sir,

I note with interest the reference to the grounded grid amplifier in Mr. D. J. Medley's article on "V.H.F. Receiver Design," "Amateur Radio" of June, 1947.

The circuit given in this article for the grounded grid amplifier (Figure 2) has a number of features which may prove disadvantageous to an Amateur trying CV66 type valves on the 166 Mc. Amateur band.

(1) The circuit published shows one side of the heater connected directly to ground. This results in the cathode to heater capacitance of the valve being connected directly across the input circuit, which in the case of a CV66 places an unnecessary reactance in shunt. The cathode impedance (input impedance) of the grounded grid amplifier is low in any case, being approximately the reciprocal of the mutual conductance, but the reactance of the cathode heater capacitance will be low as well at 166 Mc. The serious effect of partial breakdown between heater is also obvious.

These troubles can be largely avoided by the insertion of chokes in each heater lead. This places a high impedance in series with the heater cathode capacity.

(2) The amplification obtainable from the stage is a function of the effective impedance in the plate circuit. Other things being equal the higher this amplification the better is the signal to noise ratio or noise factor ultimately obtainable. Thus for the best noise factor it is necessary to make the load impedance presented to the plate by the input circuit of the following stage the optimum value. Furthermore losses in the interstage coupling circuit must be as low as possible.

The circuit given by Mr. Medley shows a double tuned interstage coupling. This type of coupling is particularly unsuitable. It is difficult to adjust the transformation ratio and will have roughly twice the losses of a simpler tuned transformer.

Using the CV66 on 166 Mc. it will be found that the output capacity is so high as to virtually prohibit the use of additional shunt capacity for tuning purposes. Series tuning of the plate circuit is therefore indicated, provided steps are taken to ensure the correct matching between plate circuit and the following input circuit.

(3) The input circuit of the grounded grid amplifier requires special consideration. The circuit published by Mr. Medley shows the cathode virtually coupled directly to the cathode with a tuned circuit tapped directly onto this line. There is an

optimum transformation ratio from the aerial impedance to the input impedance of the grounded grid amplifier, for best noise factor, and in general this will not be unity. Furthermore it is difficult to adjust the parallel tuned circuit he uses and keep the losses in this circuit low.

This is due to the low impedance which damps the circuit, and makes tuning difficult if the cathode is tapped too far up the coil. The tuning can be sharpened by moving the tap down, the coil as shown in his circuit but this greatly increases the losses and consequently the noise factor.

This would appear to be a suitable application of a broadly tuned series circuit again.

Finally I would like to emphasise the benefit to be obtained on 166 Mc. from the adequate use of the grounded grid amplifier. An improvement of 6 db can be obtained using two CV66 amplifiers compared with acorn or miniature pentodes. This corresponds to a noise factor of 5 or 6 db above thermal limit. In terms of radiated power this is a factor of four times improvement.

It is important to note that the sensitivity of a receiver on short waves is limited mainly by atmospheric and by man made noise, not by the noise generated in the aerial and in the first amplifier stage by thermal agitation. This means that practically any sort of valve can be used on short waves to realise the ultimate in receiver sensitivity. This is not the case on the ultra short waves, and receiver performance is set by thermal noise in the aerial and the effectiveness of the receiver in being noise free.

Yours faithfully,

ROSS F. TREHARNE  
(VK2IQ)

(Mr. Medley points out that the above comments are quite in order in as much as they apply to the 166 Mc. band. The article, however, was written for the 50 Mc. band where these faults would not be so serious. The points raised by Mr. Treharne were referred to in the lecture from which the article was taken, but unfortunately missed publication—Technical Editor.)

A letter has been received, signed by a number of South Australian Amateurs, suggesting a Contest for 166 Mc., together with suggested rules for the running thereof.

This letter has been passed on to Federal Executive who will no doubt take some action on the matter.—Editor.

## FIFTY AND UP

### VK CONTACTS KH6

Attention, gentlemen, for C. H. Castle (VK5KL), who worked W7ACS/KH6 on 26th August, 1947. The following is his account of the contact.

DX on 50 Mc. is not a dream any longer, but like one of Jules Verne's creations, has come true. In all my 14 years of Amateur Radio nothing has thrilled me so much, not even that first QSO or working an elusive South American. Ever since 1934 when I first QSO'd VK5IT on the old 50 Mc. band using a battery operated super-regen. receiver and a ultra-audio circuit transmitter, I have dreamed, planned and strived for better equipment and more co-operation to popularise the band.

The war years intervening, then 1946 and back on the air. Allotted 50-54 Mc. and a real chance now of DX as 50 Mc. comes well within reach of M.U.F. prediction when high enough. Improved technique, super-het receivers, crystal controlled transmitters and multi-element beams all in the right trend to bring that dream true.

All set to go, when I was transferred to Darwin in my occupation. What hope now with nearest Ham on 50 Mc. at Katherine, 160 miles away

by air. Still, the mind persisted and a converter built to liven up the front end of the communications receiver. A transmitter followed and finally a three element beam.

December, 1946. The band looked like opening up. Interstate DX was achieved. Honors to VK2NO and VK3MJ. Unfortunately I was not to participate in any of it. Rushed to Melbourne for an operation and by the time I returned and sorted out the gear, the DX season had more or less passed.

Encouraged on by activity in Honolulu, Japan, Okinawa, Singapore and India, the chance of real DX might be achieved yet. Close study of M.U.F. prediction charts and ionospheric predictions issued from Mt. Stromlo followed. Each month when severe disturbances were reported a close watch has been kept on the band.

On 22nd August a severe disturbance took place and the usual watch was kept when at home, mainly around noon. Skeds were also being kept with VK5NR and VK3BQ. Arriving home at 1200 hours on 26th August, the beam was swung in the direction of VK3, a signal was heard weakly and fading rapidly, and on identification it was W7ACS/KH6,

Pearl Harbour, calling "CQ Six." The surprise and thrill of hearing a signal at last, and what's more an international signal, with the possibility of it, if contacted, setting a record, brought on reaction in the form of severe shaking from head to foot, and panic to get the beam around and lined up on him.

Rushing outside to manipulate the ropes on the beam I became entangled amongst them in my haste. Returning inside and frantic calling, though almost unable to hold the microphone and speak at the same time, I get no reply. At 1215 hours W7ACS/KH6 called CQ, R5 and S5 now. I call on 51.6 and 50.025 Mc. with no result. At 1230 while W7ACS/KH6 is calling CQ I peak the beam on his signal and call again. The perspiration stands out on my forehead as he answers QRZ? Again I call, long and loud. All at fever pitch now for the reply. Time was 1240 and the greatest moment in my life passes as W7ACS/KH6 answers calling VK5KL Darwin and saying Well! Well! this is one for the books and offering congratulations.

His signal was S7 now and gave me S3. We continue for several overs describing each others gear and arranging sked for 1200 CST each day. W7ACS/KH6 was now S8 and a beautiful signal, as VK5SA can vouch

**"ALL-ROUND" EFFICIENCY**

**TRIMAX TRANSFORMERS**

TRIMAX TRANSFORMERS  
MELBOURNE AUSTRALIA

**TRIMAX TRANSFORMERS**  
(Division of Cliff & Building Pty. Ltd.)  
29-35 FLEMINGTON RD., NORTH MELBOURNE

Available in Line to Line, Line to Grid, Plate to Line, Interstage—Single and Push-Pull Types—Trimax Transformers are constructed of the finest materials and feature high Permeability, Nickel Iron Alloy core—heat treated in our own factory for Optimum results. Also for Amplifier enthusiasts . . . Standard or Custom built Chassis, Speaker Flares, Microphone Stands, Power Transformers, Filter Chokes, etc.

Interstate  
Representatives:

N.S.W. :  
L. B. Graham,  
5 North York St.,  
SYDNEY

QUEENSLAND :  
Chandlers Pty. Ltd.  
Chr. Albert and  
Charlotte Sts.,  
BRISBANE

S.A. :  
C. N. Muller  
Waranda Buildings,  
Grenfell Street,  
ADELAIDE

W.A. :  
R. D. Benjamin,  
197 Murray Street,  
PERTH

TASMANIA :  
W. & G. Genders  
Pty. Ltd.,  
53 Cameron Street,  
LAUNCESTON

ENQUIRE FROM YOUR NEAREST SUPPLIER



PHILIPS

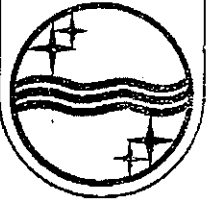

Calibration immediately pin-pointed

Replaceable indicator Scale. Five ranges

Available NOW!

# PHILIPS LOG DIAL

for easy, accurate, individual calibration

Specially designed for transmitting radio amateurs, short-wave listeners and equipment engineers, the new Philips "Log-Dial" is the ideal control and indicator mechanism for VFO (Variable Frequency Oscillator) Transmitter application, Amateur Band HF Receiver bandspreading, VHF Receiver tuning, Frequency Meters, Monitors and for many other radio and electrical applications. The Philips "Log-Dial" mechanism provides positive, smooth running with no slip or backlash. It has an ample reduction ratio

for quick or slow tuning; calibration cannot be affected by mechanical troubles. The off-set Cursor provides instant logging without the need for scale reference or movement. The two-colour scale is removable, two are included with each "Log-Dial", and further replacements are available. It may be mounted on front of or behind instrument panel. The Philips "Log-Dial" is designed for 1/4 inch shaft drive but is adaptable to larger sizes. It is finished in attractive Florentine Bronze.

25/-

● The "Log-Dial" is available now from your nearest Philips branch; the price is only 25/- with special reduction for licensed amateur radio transmitters.



PHILIPS ELECTRICAL INDUSTRIES OF AUSTRALIA PTY. LTD.

Sydney • Melbourne • Adelaide • Perth • Brisbane

for because he lives next door and came in to witness the closing over. The contact lasted for 10 minutes and closed with both of us looking for any other stations. I relaxed with radiant joy as I realised that I may have that coveted honour of being the first VK to work outside Australia on 50 Mc.

**DX on 50 Mc?** Yes it is an accomplished fact and no telling what the next six months will bring as the M.U.F. rises. W.A.C. maybe. Who knows. Time will tell.

We wish to point out that, up to the time of going to press, no official confirmation of above contact has been received.

#### VK8 FIELD DAY

On the pleasant, but cloudy, afternoon of 7th September, a Field Day was held in VK3 (maybe in other States also, but no notes to hand, save VK4s). The portable stations in VK3 were SABA-3YS, 3RR-3XA, 3UI-3BG, 3MB, 3HK-3YJ, and 3ABU.

SABA and 3YS could not go to Mt. Tarrangower as planned, but worked from a spot 600 feet high north of Warrandyte (25 miles N.E. of Melbourne). Fred and Jim used their c.c. portable with 832 in the final and 3 watts input. 50 Mc. received was 1852 and 6J5 into Type 108 and half wave horizontal antenna. On 166 Mc. the 832 was used as a tripler with output of 1/2 watt. Antenna was half wave vertical; receiver a super-regen. Stations worked were all on 50 Mc., being VKs 3ADF, 3MJ, 3HT, 3PG, 3BD, 3HK, 3DA. Heard 3RR, 3BW, 3CP, 3MN, 3RO, 3VL. No contacts on 166 Mc. due to low power possibly but heard 3EM, 3AKI, 3MN all S8.

3UI (with 3GD and 3TS) went to 3ABG's, thence to a 1600 feet high hill, 12 miles east of Avonell (70 m. N.N.E. of Melbourne). The two separate rigs were set up 20 yards apart. 3ABG used 12 watts to 807 class B linear amp., and 3UI used 15 watts from genemctor and receiver off vibrator. 3UI used half wave horizontal 20 feet high. Both 3UI and 3ABG worked 3HT who passed the news around to the Melbourne stations without resulting in any more contacts. 3HT was S8 and gave 3UI S5 and 3ABG S3. Stations heard were 3ADF S3, 3RR S5, 3CS S3. At 1230 3ADF was S3, at 1631 was S4 and at 1721 S8.

3MB was at Arthur's Seat, 38 miles south of Melbourne. On 166 Mc. Ron used p.p. CV6s mod. osc., modulated by 6K6G. Receiver was 955 into a 6K6, and antenna was a 3 element rotary beam. The following were worked at good strength both ways: 3RR, 3MN, 3AKI, 3ACM, 3LS, 3EM and 3EO. 3TZ and 3MB heard each other but did not contact due to "flat" battery (moral, carry spare battery).

3XA and 3RR were at Macrae, 36 miles south of Melbourne. Gear used on 166 Mc., 3RR Tx 6V6 c.o., 6V6 tripler, 6V6 doubler, 6J6 (each section as separate doubler), 832 final

with 30 watts. On 50 Mc. same set up but omitting 6J6. Receiver on 166 Mc. was 3RR's modified ASV 11 tube superhet; 50 Mc. receiver of 3XA used 6AG5, 6AG5, 8C4 into 5 tube d.w. mantel set. 166 Mc. antenna was 3XA's beam 20 feet high; 50 Mc. used half wave horizontal. On 50 Mc. they worked 3HT, 3MJ, 3BD, 3BQ 3AN, 3HK (S9), 3ABU (S5), 3RO, 3CP, 3ZL and 3GM (at Ballarat, 82 miles airline), and 3KX (at Colac 72 miles) S7. On 166 Mc. 3MN, 3LS, 3AKI, 3MB, 3EM and 3ACM were worked.

3HK and 3YJ were at Mt. Dandenong, 22 miles east of Melbourne. Equipment was probably 3HK's c.c. portable with 807 and 5 watts, and receiver a converter into a FS6. As neither Jeff or Keith sent any notes I cannot give any further details.

#### FIELD NOTES FROM VK4

Unfortunately for VK4s the 7th September was a wet, very, wet day in south east Queensland. Definitely the worst day possible for a field day. Nevertheless 4ES, 4CU and 4LN operated portable from various mountains within a 50-100 mile radius of Brisbane. Owing to the inclement weather, operations were confined to 50 Mc., and the test proved perfectly satisfactory as far as local contacts went, the only possible DX heard was someone on m.c.w. who called 4ES on Mt. Glorious. Your narrator had the doubtful privilege of blotting him out. We would very much like to identify this station, so QRZ, please speak up.

The co-operation of 4LN, 4CU, 4AF and 4SN and others on field days is much appreciated by the local gang and the warmer weather should yield some outstanding results on similar events.

#### 50 Mc. JOTTINGS

VK3MJ has departed to the land of DX, heat, wogs, etc., Darwin to wit. Is now active with the call sign VK3AE. Good luck, Dave.

VK4LN's antenna on 50 Mc. is 110 feet high. How do you de-ice it Barrie?

The VK4 gang are going in for power increases in quite a big way. 4HR is threatening to run 80 watts. 4FB has stepped up the herbs, and 4RY has also turned up the wick and added a new modulator. A vastly improved signal on 50 Mc. is that of 4JY.

August 15-17 saw VK6SA out again, this time off Garden Island and Rockingham. Excellent signals the whole of the time from Jim's f.b. portable.

Usual weekly activities in VK6 are proceeding well, including tests with f.m., but there's plenty of room in the band for others.

VK6FB (Mullewa) has completed new exciter and VK6WZ (Gerad-ton) is ready with new converter to carry out listening tests as soon as 6FB's final is finished. Hope to be able to announce Frank's sked times in next issue, so we can try the 300 miles between Perth and Mullewa.

The N.S.W. V.H.F. Section held a Field Day on Sunday, 7th September, also, in which the 166 Mc. gang had some great fun, and did some good work. Nearly everyone managed to work each other, with the exception of VK2PW who was operating from a raised spot at Kiama on the South Coast. His two contacts were both in the record breaking class--the first with VK2AHG at Kurrajong, a distance of about 80 miles airline, and with VK2ABB in Sydney, the latter

# GLO-RAD

CUSTOM BUILT EQUIPMENT

CAREFULLY ENGINEERED TO MEET

YOUR INDIVIDUAL REQUIREMENTS

"GLORAD" is now in a position to cater for  
YOUR requirements, large or small.

Send sketches and full details to:—

GLORAD ENGINEERING SERVICES

186A Riversdale Rd., (Cr. Robinson Rd.)

HAWTHORN ————— VICTORIA

Phones: Day—WA 3819. Night—WX 3440

being a particularly interesting contact.

Stations 2KI at Mt. McAllister, Goulburn, 2YE at Hornsby, and 2ADY at Cowan Heights were also on the road, and had many contacts. So many stations are now on the band that it looks as though crystal control will be needed to prevent chaos when everyone starts up at once. Most of the stations are now using beam aerials.

### "166 AND ALL THAT"

Acute shortage of Interstate notes, save VK4, re this band. In VK3 activity is very quiet, save on field days. The boys either seem to be away or busy building, etc. 3ACM has his modified ASV super going well and is very pleased with it. 3IV has got interested on 166 Mc. and expects to have a rig mounted on a pole right up at the antenna.

3ACM, to get band spread on his ASV receiver, used smaller osc. inductance and more lumped capacity, this helped stability also.

Signals on 166 Mc. appeared to decrease in strength from 12 noon to dusk on the Field Day when it was noticed that VK3RR (Macrae) faded to a strength that he could not be worked. The signal strength increased after dusk to a value not quite as great as at 12 noon.

Stations active on this band in Brisbane are 4ES, 4FB, 4HR, 4JY, 4KB, 4XG and 4TR, although the last named has been in a spot of bother with long lines. We spoke last month of 4HR's 522 and feel obliged to mention that Tibby found it preferable to fit individual oscillators for both 50 and 166 Mc. reception. Otherwise the job is as mentioned in the September "A.R."

4XG built up the 166 Mc. rig described in the Handbook, but could not get satisfactory operation of the 6C4 buffer and found that results using a 9003 in that position were quite impressive. The rig referred to is the 6C4, 6C4, 815.

### "1,400 Mc. OR BUST"

3VM has tried a double cavity oscillator using a 2C40, and feeding into a dipole with parabolic reflector. (I would love to tell you what he used for a reflector but can't, it came out of his XYL's frigidaire.) He used a dipole and crystal detector and microammeter for making some field strength tests. Complains that 1,400 Mc. is too low for effective work.

Another VK3 has bought three GL446Bs, one to use and two as replacements! It is said that "light houses" go into cavity resonators OK, but come out in pieces.

### UP WITH THE ANGELS—

10,000,000,000 Cycles per Sec.

As 3VM considers 1,400 Mc. too low, he will be establishing a circuit with 3DH on 10,000 Mc. in a month or so, when the necessary gear arrives. Will all good Hams say a prayer for the boys at Mont Park checking station?

## FEDERAL QSL BUREAU

### RAY JONES, VK3RJ, MANAGER

Stations in VK9 are again reminded that incoming cards can be obtained from VK9GW, Mr. G. Warner, c/o. O.T.C., Port Moresby, by the usual stamped addressed envelope method.

The QTH of VK9BI is now: Arnel Wilkey, c/o D.C.A. Finschhafen, T.N.G.

The Russian Arctic Expedition whose station signs RAEM/MM can be heard on 14,035 Kc. with a drifting T5 note, around 0530 E.S.T.

Further to paragraphs in these notes some months back regarding QSLs to PK6HA. The backwash is now to hand. A few VK stations now claim that the boot is on t'other foot and that cards from PK6HA are still outstanding. The next move is yours Lt. Hagers. Among those awaiting your card is VK7JH.

To the moment of writing the long awaited second list of call signs and addresses of Australian experimental stations, is still not to hand. The publication was expected to be available during 2nd week in August. Apparently it will again be a little out of date when issued, but the quarterly supplements should catch up on the leeway.

An interesting write up of the gear and work done by VK3GE at Balcombe appeared in a July issue of the Mornington Post, together with an excellent picture of the owner, Lt.-Col. George Every, and the set up. Glad to see you looking so well George and congrats on the outfit.

The Victorian QSL Manager, Graham Roper, 26 Lucas Street, Caulfield, S.E.8, is waging an uphill fight, what with the absence of an up-to-date VK call list and the reluctance of addressees to claim their cards. The list below shows those unclaimed to September 3. Anyone mentioned therein is urgently requested to do the right thing and make arrangements for the collection of their cards. After 1st November all unclaimed cards appearing in this list will meet the fate they deserve. If any country call signs are included in the list, the owners are requested to contact VK3ZB, as he has no means of knowing who is who among the stations licenced during the past 12 months.

VK3s: ACF, ACG, ACM, ACX, AES, AFD, AFQ, AGE, AGJ, AHK, AHM, AHR, AIG, AII, AJB (ex-VK7JB), AJX, AJY, AKI, AKM, ALR, ALS, AN, AO, AOZ, APM, ARD, ARH, ART, AS, AT, ATH, ATR, BG, BK, BP, BS, CM, CU, CX, DA, DD, DG, DH, DS, DZ, EJ, ES, EW, EX, FE, FF, FO, FW, FX, GB, GC, GF, GG, GK, GR, GT, HC, HD, HJ, HP, IU, IW, JG, JH, JP, JR, JS, JW, JZ, KD, KI, KO, KT, KU, KV, KW, KY, LB, LC, LD, LG, LJ, LP, LR, LU, LW, LZ, MD, MP, MR, MS, MW, MX,

## SUCH NICE PEOPLE

### By "GREMLIN"

To 3CN and 3TM, greetings. Yep, I too have a soft spot in my heart for the proficient c.w. chappie. Usually his fone work is equally good. I agree with the Federal Executive policy of reducing restrictive regulations to a minimum, but I do think every Ham should aim at becoming proficient in all phases of operating and it should be the policy of the W.I.A. to foster that aim. I don't agree with the many who say c.w. is an unnecessary evil and about as useful as a boil on the saddle contact of a boundary rider. Who gets the most out of Amateur Radio? Barring the disposal joints, I say the 25 w.p.m. boy. Try it and see!

Anybody wanting a wrecked car fixed, or a fixed car wrecked, see 3XC. I reckon quite a few got some chuckles from your hair-raising narrative on 7 Mc. recently, Willy. —...— The new CQ champ, 3LV, decrowned Cobber Alf with 34 straight and mournful ones. Don't worry Alf, the title still belongs to VK3.

Afraid the grudges are few this month. Truth is I've been busy doing nothing. Only the XYL knows how busy that can keep me. Been propping the old plates on the mantle most nights and delving into formes to see what makes pulses and other strange devices tick. Plenty of interesting dope available on frequency modulation, but what every young Ham should know about Pulse Transmission is more elusive. —...— Mr. W.R.G. I'm starving and that food for thought in regard to Pulse Technique is eagerly awaited. Big helpings please.

3LJ the worst splashing offender I heard this month. 4JP, 2FJ and 3GN to a lesser degree. Pretty hefty hum on 3MS phone. —...— 2ARE, 2BC, 2ALG, 3EG and 3TX noticed with clicks, 3ZW and 2GS with chirps and 2ML with a rough note. —...— 2FA operating on 14 Mc. has a fair harmonic on 28 Mc. Your voice tricked me a couple of times Don, thought you were DX.

Before I forget, the bloke who sets up print, or whatever they do, had the wrong idea last month. My rig is haywire, not Amateur Radio. Of course if all rigs are like mine, last month's version stands! —...— By the way, 3FP may have some sound ideas on screen modulating an 813.

NA, NB, NG, NW, OU, OZ, PA, PB, PE, PH, PI, PK, PZ, QB, QC, QG, QL, QN, QQ, RF, RI, RK, RT, RV, RW, TD, TO, TR, TY, TZ, UD, UF, UO, UP, UQ, VA, VB, VE, VF, VM, VN, VY, WL, WN, WR, WX, WZ, XA, XG, XJ, XN, XS, YF, YG, YH, YK, ZH, ZY, and ZV.

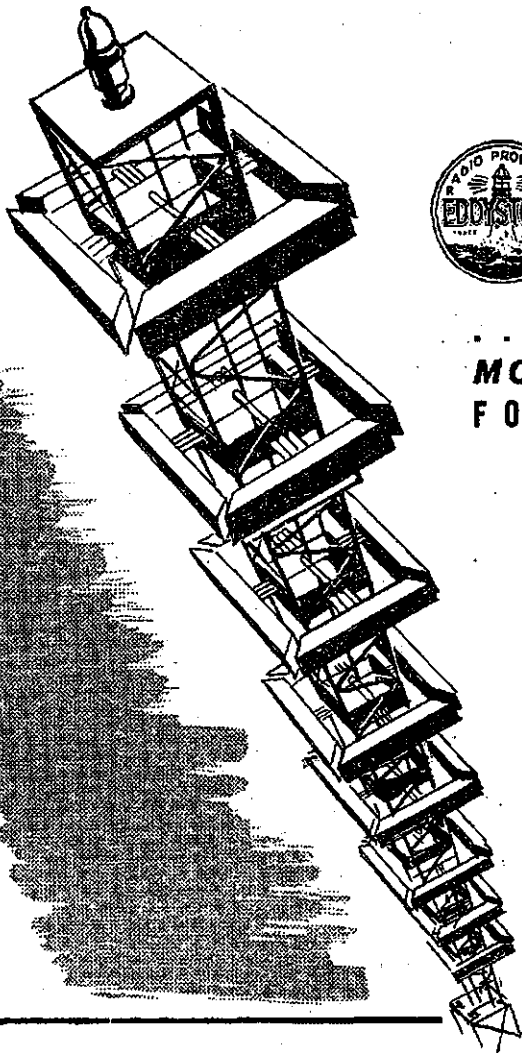

# EDDYSTONE

**... OFFERS YOU THE LATEST  
MOST DEPENDABLE COMPONENTS  
FOR F.M. AND PULSE ...**

New Eddystone equipment is continually being designed to keep abreast of the rapid progress being made in the F.M. field. Eddystone equipment is available for every phase of F.M. work—giving you the splendid opportunity of setting-up a complete F.M. station with high quality Eddystone components, and thus ensuring a uniformly high working standard throughout. All who have used Eddystone components have been appreciative of their unsurpassed efficiency and reliability—features which have made Eddystone components undisputed leaders in their field. Watch for future announcements concerning these famous components, for Eddystone will be bringing you the **LATEST, MOST DEPENDABLE** equipment for both Frequency Modulation and Pulse Transmission.

**FOR DETAILS OF COMPONENTS SUITABLE FOR F.M. AND PULSE  
CONSULT YOUR DISTRIBUTOR . . .**

● **VICTORIA: J. H. MAGRATH & CO.,**  
208 Little Lonsdale Street,  
Melbourne.

● **QUEENSLAND: CHANDLERS PTY. LTD.,**  
Cnr. Albert and Charlotte Sts.,  
Brisbane.

● **STH. AUSTRALIA: GERARD & GOOD-  
MAN LTD.,** 192-196 Rundle Street,  
Adelaide.

● **N.S.W.: JOHN MARTIN PTY. LTD.,**  
116-119 Clarence Street,  
Sydney.

● **WEST AUSTRALIA: CARLYLE & CO.,**  
Hay Street, Perth, and 397 Hannan Street,  
KALGOORLIE.

● **TASMANIA: W. & G. GENDERS PTY.  
LTD.,** 53 Cameron Street,  
Launceston.

**AUSTRALIAN FACTORY REPRESENTATIVES:**

**KEITH HARRIS & CO. PTY. LTD. 51 William St. Melb. Phone—MB 2119**

## FEDERAL NOTES

The Federal Executive desires to place on record the excellent services rendered by Mr. R. H. Cunningham (VK3ML) who through the pressure of business, has tendered his resignation as Contest Manager.

You are all fully acquainted with the able and efficient manner in which the contests have been conducted over the many years that he has occupied the office of Contest

It is with great pride and very many thanks that the Federal Executive announce the donation of an Eddy-stone Model 640 receiver by Messrs. Stratton & Co. Pty. Ltd., of London, for the official use of the Federal Station VK3WIA. This receiver is en route to Melbourne and when received will no doubt be put to very great use in the operation of VK3WIA.

Manager and it is with great reluctance that the Federal Executive has accepted his resignation.

In making the appointment of Mr. E. H. Jenkins (VK3QK) as the new Contest Manager, Federal Executive feel confident that the same high standard set by Bob Cunningham will be maintained. With a programme of four contests being conducted annually, namely VK International in October, National Field Day in January, Trans-Tasman in May, and Remembrance Day Contest in August, it will be readily appreciated that the need for an assistant is very important and in this connection Mr. L. S. Dixon (VK3TE) has offered his services and has been duly appointed as Assistant Contest Manager.

To most members the efforts of the Federal Secretary are comparatively unknown; but to the Federal Council and Executive they are very well known and greatly appreciated and with the resignation of Alex H. Clyne (VK3VX) another very capable administrator has been lost from the Federal sphere. Alec's resignation has been due to pressure of personal business and it is again desired to record the excellent services that he has rendered during the past two years as Federal Secretary.

Federal Executive desires to thank all of the above members for the efforts and the hope that the retiring ones will not lose an active interest in the Amateur movement.

### REGULATIONS AMENDED

The P.M.G. Department has notified all Amateurs of the following amendments to the Wireless Telegraphy Regulations:—

"Experimental Station Licences" will be officially designated "Amateur Station Licences" and their Stations will be referred to as "Amateur Stations."

Only one class of licence will be issued instead of two as formerly. Irrespective of the class of licence and certificate now held, power not exceeding 100 watts may now be used by all licences. It will be unnecessary for the existing Class "B" licences to be amended in this regard.

Only one class of Certificate will be issued instead of two as formerly. It will be known as the "Amateur Operator's Certificate of Proficiency." No amendment to the existing Certificates will be necessary.

### NEW HANDBOOK

Last month we asked for suggestions and comments on the material

which you think should be included in the new companion publication to the Postmaster General's Department Handbook, up to the time of writing these notes no suggestions, etc., have been received so what about getting those thinking caps on and letting the Federal Secretary have whatever you can.

### RESULTS OF B.E.R.U. CONTEST

Message No. 3 to VK3ML de G6CJ, 23/8/47:—

Senior B.E.R.U. 1947—198 logs:—

ZS2AL	1864	points
VQ3HJP	1350	"
ZL1BY	1225	"
VK2EO	1118	"
G5WP	1558	"

VK2ADE }  
VK2DI } 6th and 7th, equal

Junior B.E.R.U., 1947—85 logs:—

ZL4GA	828	points
VS9AN	732	"
ZB1AD	658	"
VK4RC		"

VK5RX } 6th and 7th, equal  
G8IL ..... 469 points

Owing to complications of fuel restrictions no awards are being made in G this time.—Signed G6CJ.

### W.I.A. 1947 INTERNATIONAL DX CONTEST

Prizes for the Contest to be held over the week-ends of October are as follows:—

Transmitting c.w. open.—1st, Pair 800s and pair 866As; 2nd, 5BPI and AV11 High Voltage Rectifier.

Transmitting phone open.—1st, Dynamax Microphone with a desk stand; 2nd, Type TA907 Modulation Transformer.

28 Mc.—Phone, AR301 High Frequency Receiver; C.W., "KS" 9'er (less tube).

14 Mc.—Phone, Eddystone parts to the value of £5; C.W., Transformers and Chokes to the value of £5.

7 Mc.—8" Speaker, Pair 6AC7s and one subscription to QST or CQ.

Receiving.—1st, 8" Speaker, Pair 6AC7s and one subscription to QST or CQ; 2nd, Pair 6AC7s and one subscription to QST or CQ.

A prize to the value of three guineas, yet to be determined, will be awarded for the 3.5 Mc. band winners.

Where insufficient entries in one section make the granting of the prize unnecessary, that prize will be added to those in another section.

Entrants may compete, and be eligible for prizes, in any one, or all sections, provided a separate log be forwarded for each section. Contacts for one band sections may count in the open section.

Contacts with other VK districts must not be counted, and VK7 and VK9 districts must not be counted as multipliers.

As New Zealand are not associated with the W.I.A. in this Contest, contacts with ZL will naturally count and ZL will be a multiplier.

In addition to the prizes donated by

# Bright Star Radio

VK3UH

1839 LOWER MALVERN ROAD  
GLEN IRIS, S.E.6, Vic.

Phone: UL 5510

TAYLOR TRANSMITTING  
TUBES

Full Range

Crystals as illustrated.



40 and 80  
metre.  
AT or BT  
cut. Accuracy 02% of  
your  
specified  
frequency.  
£2/12/6

20 metre zero drift, £5.  
Crystals Reground, £1 each  
S.A. hams may obtain crystals  
from A. G. Healing,  
Box 645, Adelaide.

West Australian: Messrs.  
Atkins W.A. Ltd.,  
Box D147 G.P.O., Perth.

Queensland: Messrs. A. E.  
Harrold, Box 593J, G.P.O.,  
Brisbane.

SPECIAL! While they last.  
Very limited number.  
BENDIX FREQUENCY  
METRES.

Complete with calibration  
book, in perfect order.  
Know your frequency within  
cycles. The ideal V.F.O.  
£30 each

# TECHNICAL BOOK & MAGAZINE CO.

297-299 SWANSTON STREET, MELBOURNE

(Opposite Old Melbourne Hospital)

Central 2041, Melbourne, C.I

We can arrange subscriptions to any of the following magazines:

## AMERICAN.

AUDIO ENGINEERING . . . . .	27/- year	COMMUNICATIONS: . . . . .	24/- year
Q.S.T.: . . . . .	27/- "	RADIO NEWS: . . . . .	40/- "
C.Q. . . . .	25/- "	RADIO CRAFT: . . . . .	22/- "
SERVICE: . . . . .	24/- "	SCIENCE DIGEST: . . . . .	23/6 "
F.M. & TELEVISION: . . . . .	48/- "	PROCEEDINGS INST. OF RADIO ENGINEERS . . . . .	104/- "
ELECTRONICS . . . . .	97/6 "	POPULAR SCIENCE: . . . . .	23/6 "
SPECIAL RATE FOR THREE YEARS . . . . .	195/-	POPULAR MECHANICS: . . . . .	23/6 "

## ENGLISH AND AUSTRALIAN.

WIRELESS WORLD: . . . . .	25/- year	WIRELESS ENGINEER: . . . . .	42/- year
PRACTICAL WIRELESS . . . . .	10/6 "	ELECTRONIC ENGINEERING: . . . . .	33/- "
AUST. RADIO WORLD: . . . . .	10/6 "	RADIO AND HOBBIES: . . . . .	6/6 "
AMATEUR RADIO: . . . . .	6/- "	SHORTWAVE MAGAZINE (English): . . . . .	25/6 "

## FOREMOST IN AUSTRALIA FOR TECHNICAL BOOKS.

our manufacturers, attractive certificates will be awarded to the section winners and also to the section winners in each state of Australia.

A special word of appreciation is given by the W.I.A. to the following manufacturers for their generous donations which will be an added incentive in the Contest:—

Trimax Transformers, Melbourne.  
Swales & Swann, Melbourne.

Technical Book & Magazine Co., Melbourne.

Keith Harris & Co., Melbourne.  
Rola Co., Melbourne.

Amalgamated Wireless Valve Co., Sydney.

Stearns Sound Systems, Melb.  
Kingsley Radio Pty. Ltd., Melb.

Philips Electrical Industries, Syd.  
16 Swan Street Pty. Ltd., Melb.

### LIST OF CALL SIGNS

As announced in these columns last month the following is a list of the alterations, additions and cancellations of call signs advised by the Wireless Branch of the P.M.G.'s Department:—

#### New Licensees

VK2IM—V. A. Tobin, 204 Cornish St., Railway Town, Broken Hill, N.S.W.

VK2IN—J. H. Kebblewhite, 41 Burns Rd., Wahroonga, N.S.W.

VK2IT—W. R. Beveridge, "Karoola," Alfred St., Mittagong, N.S.W.

VK2IW—F. A. BORCHARD, 538 Wolfram St., Broken Hill, N.S.W.

VK2JM—M. C. Laybutt, 3 Oxley St., Kingston, A.C.T.

VK2NT—J. W. O'Neill, 11 Highview Ave., Neutral Bay, N.S.W.

VK2TJ, J. W. Thompson, 11 Temple St., Stanmore, N.S.W.

VK3EI—S. C. Broadbent, 184 Victoria St., Ballarat, Vic.

VK3IQ—K. J. Duff, 24 Rundle St., Ararat, Vic.

VK3MF—K. M. Dobbyn, 42 Walnut Ave., Mildura, Vic.

VK3NQ, F. K. Barker, 24 Northernhay St., Regent, N.18, Vic.

VK3RY—G. R. L. Hancock, 93 Charles St., Northcote, N.18, Vic.

VK3SW—J. M. McConnell, 50 Albert St., Geelong West, Vic.

VK3AIT, I. M. Templeton, Sutcliffe St., Sea Lake, Vic.

VK3ATP—C. N. Pickering, 61 Ardmillan Rd., Moonee Ponds, W.4, Vic.

VK4TW—A. W. Tarling, 22a 6th St., Townsville, Qld.

VK4UK—F. R. O'Sullivan, 68 Walker St., Bundaberg, Qld.

VK5BA—Reverend P. Smith, Box 22, Snowtown, S.A.

VK5HC—J. K. Carruthers, 21 Clifton St., Hawthorn, S.A.

VK5MS—M. S. Millowick, West Lane, Roseville, Mt. Gambier, S.A.

VK5PX—P. R. Walker, Daly St., Sth. Plympton, S.A.

VK5VO—A. W. N. Sobey, 21 Fern Ave., Fullarton, S.A.

VK5ZR—R. A. Kelton, 55 Crozier St., Mitcham Park, S.A.

VK6AE—H. A. Lee, 21 Outtrim St., West Perth, W.A.

VK6BJ—K. M. Bunn, 80 Mackie St., Victoria Park, W.A.

VK6JW—J. C. Watson, 20 Lawley Cres., Mount Lawlet, W.A.

VK7EJ—E. J. Cruise, "Beaumaris," Montpeller Rd., Hobart, Tas.

VK7WG—W. G. Gough, 44a St. George's Terrace, Battery Point, Tas.

#### Alterations

VK2ACX—A. W. Stowar, now 12 Schackel Ave., Kingsgrove, N.S.W.

VK3AGQ is now VK2AGQ—G. E. Doughty, now 8 Carlow St., North Sydney, N.S.W.

VK3DC—D. G. Caldwell, now 88 Spray St., Elwood, S.3, Vic.

VK3PF—J. H. Lawrence, now 32 McLaughlin Ave., Sandringham, Vic.

VK4UJ—P. L. Dubois, now "Bendmere," Lower River Terrace, Sth. Brisbane, Qld.

VK4ZY—C. E. J. Burns, now 340 Sheridan St., Cairns, Qld.

VK5QI—L. E. Davies, now 18 Tyson St., Ashford, S.A.

VK6BK—R. C. Krummel, now 179 Railway Rd., Gooseberry Hill, W.A.

#### Cancellation

VK2YI—H. W. Blue, 55 Leura Rd., Auburn, N.S.W.

# DIVISIONAL NOTES

## NEW SOUTH WALES

Secretary: Peter H. Adams, VK2JX  
Box 1734 G.P.O., Sydney.

Meeting Place: Science House, Gloucester and Essex Streets.

Meeting Night: Fourth Friday of each month.

The August meeting of the Division was held on 22nd August at Science House, with a particularly good attendance. The lecturer for the evening was Ray Howe (2ARH), his subject being aerials, with particular reference to matching and phasing of arrays and feed lines.

Ray supplemented his story with a few practical examples, with particular reference to co-axial cable, and the use of unbalanced feed lines to aerials. The lively discussions which followed indicated the success of the lecturer.

The Divisional Council has completed its proposals to link up with Radio Clubs on a Member Club basis, which it is hoped will bind together all such Clubs with the Institute. It will mean, too, that Club members who are not Institute members will, through their Clubs, have a link with the Institute. The scheme will be discussed at the September general meeting. Those Clubs already consulted have expressed themselves as agreeing in principle to the proposals.

The Council also had a long session recently on the proposals for the new W.I.A. Constitution, which this Division hopes will eventually become a single document to cover the whole Institute. The Council has also commenced preliminary analysis of its own Divisional Constitution preparatory to revising it in the light of today's requirements. These two projects must of course be considered together.

Peter Adams has found the addition to his household, plus business pressure, a big handicap in handling the ever-growing secretarial work of the Division. The Council would be glad to hear from anyone who is able to take over this important job. One of the younger enthusiasts is to be preferred—the older gang are finding it harder and harder to keep the ball rolling. What about giving them a break?

At the September general meeting the V.H.F. Section will give a demonstration and lecture on the use of high frequencies. Neville Williams (2XV) has made a number of recordings on 50 Mc. and will bring them along together with his gear and accompanying story. Should be an interesting night.

VK2WI now operates on the 50 Mc. band each week with Institute news. It helps to keep V.H.F. enthusiasts in the picture, apart from recognising

the band as a logical local channel for domestic use.

### N.S.W. ZONE OFFICERS

North Coast and Tablelands:—  
2AFP, Casino.

Newcastle and District:—2FP,  
Hamilton.

Coalfield and Lakes District:—2YL,  
Cessnock.

Western:—2QA, Nyngan.  
South Coast and Tablelands:—  
2ANN, Bega.

Southern:—2OJ, Albury.

### COALFIELDS AND LAKES ZONE

2KF, our new Ham, is using 14 Mc. phone and c.w. mainly. — 2KZ is having good time with Ws on 28 Mc., aim is to W.A.S. on this band. Should have eight half waves in phase soon. — 2YO heard last on 14 Mc. phone, how about ringing Cessnock 53. — 2XT still on 7 Mc. and should be making noises with all the gear available. — 2MK getting ready for 50 Mc., meantime is active on 28 Mc. phone. — 2PZ using 7 Mc. phone at present, but building 50 Mc. super and should make the V.H.F.s soon.

2ADT is "always doing things." Up and works 2LY (Katoomba) and 2YQ (Schofields) on 50 Mc., plus 2OC, 2BZ and 2AHA; frequency 51.17 Mc., aerial 3 element vertical rotary. — 2YL playing much tennis, but has 120 post-war and is ready to go on 50 Mc. very shortly. — 2OC very consistent on 50 Mc. — 2AIO at the Entrance is on 14 Mc. phone. — 2TX, an old-timer, making a comeback on all bands. — 2RU on 50 Mc. mainly, sometimes makes the 14 Mc. DX band. — 2AMU will be on 50 Mc. soon. — Old timers 2KR and 2GA active on 7 Mc. phone.

### NEWCASTLE AND DISTRICT ZONE

2BZ is very keen on 50 Mc., spends a lot of time there with good results. — 2AFS has now a 100TH in the final; it's on a holiday with only 70 watts. — 2CS doing the proper thing, building all the refinements before the transmitter proper. — 2AGD unfortunately lost his beam, unwound off the pipe thread, getting rebuilt to new design; watch for a big signal. — 2AHA working all bands, over 100 up post-war. — 2PQ has busted one rock, back with a vengeance and improved quality.

2ZC treating all bands with a fine signal. — 2FP has 80 post-war countries on 28 Mc. phone and 35 watts; finds them hard now. — 2TE heard early in the month on 28 Mc., hope no trouble.

### SOUTH COAST AND TABLELANDS ZONE

The following comes mainly via the grapevine. 2TA, 2TC and 2PN are all active on 50 Mc., the latter with automatic keying. — 2DO has a new receiver on 50 Mc. — 2AKE inactive, is rebuilding. —

2JQ and 2ALD, our two clerics, were heard rag-chewing on 7 Mc., middays. — 2GU seems to be interested in DX again. — Old timer Les Edwards, ex-2LM, hopes to make a comeback from Merimbula. — 2ANN is building a plate modulator (p.p. 830B) for the 813. — 2MT busy placing a crystal in the receiver.

### SOUTHERN ZONE

2VK re-vamped transmitter and is mainly active on 7 Mc. — 2GG moved to Sydney, let us know your QTH Jim. — 2QD back in civvy life again, to be heard shortly. — 2EU has the worries of home building, using temporary shack and aerial. — 2APW pleased with frequency meter. Is active on 7 and 14 Mc. — 2JA not heard yet, illness prevented activity, hope OK now. — 2AIB frequently heard on 7 Mc. phone and c.w. — 2BC (ex-Alburyite 2WB) spent holidays here. — 2OJ waiting for a fine week-end to complete out-door jobs.

### WESTERN ZONE

2BT has new AMR300 receiver and finds it helps with the DX. — 2WH erecting V beams, results so far are patchy. — 2II rebuilt r.f. section of receiver, also using co-ax. — 2AMR exclusively on 14 Mc. with co-ax fed doublet. — 2ACT on 7 Mc., still interested in disposal gear. — 2NS rebuilding entire shack, heard using voice controlled transmitter. — 2TG is still after new countries on 14 Mc. c.w.

2ALX uses a AT20 with nice phone. — 2ACU QRL, only using a Type 3. — 2HZ still building receiver. — 2QA contemplating many changes with the change of QTH. — 2LZ still on the highs, somebody mentioned a comeback on 7 Mc. — 2KI, 2AFO and 2LY also busy from the Mountains on the V.H.F.s.

## VICTORIA

Secretary: A. B. D. Evans, VK3VQ,  
Box 2611 W G.P.O., Melbourne.

Meeting Night: First Wednesday of each month.

Meeting Place: Radio School, Melbourne Technical College.

### COUNCIL JOTTINGS

At the last Annual General Meeting held on 6th August, 1947, the following office-bearers were elected and is published herewith for your information: President, R. H. Cunningham (VK3ML); Council: A. E. Tinkler (3ZV), M. J. McCartney (3KV), E. M. Hooper, H. Webber (3PW), H. N. Stevens (3JO), C. C. Quin (3WQ), H. Chapman (3GU), W. L. Matters (3WW).

At the first Council meeting for the year a new post was created in the form of Communications Manager for the administration and operation of VK3WI. Mr. A. E. Tinkler (3ZV) was appointed to fill the position.

In view of the excellent management of the previous Magazine and Disposals Committees all these members were re-appointed to carry on the good work.

Financial affairs of the Division have been so capably handled by Mr. J. Marsland (3NY) in the past, his re-appointment as Treasurer was completely unanimous.

Publicity and Magazine Notes were placed in the hands of M. McCartney (3KV). All Zone and Committee Secretaries are asked to forward notes on the month's activities direct to 3KV before the 12th of each month to ensure publication.

There was the usual full attendance at the September general meeting held on the 3rd of the month. Visitors present included Bill Marshall (VK2XM), Ray Bennett (VK5RC), also G. Russell, W. Robins and W. Manning.

Before the commencement of general business for the evening an educational film on the basic principles of Loran (Long Range Navigation) was shown.

VK3KM raised the issue of the appointment of a paid, full-time secretary to handle the affairs of the Victorian Division. It was generally felt by all present that an appointment of this nature is highly desirable and it was left to the Council to investigate the ways and means.

#### FIRST POST-WAR DINNER

The Victorian Division will hold their first post-war Dinner at the "Hotel Federal" on Saturday, 22nd November. Tickets for the Dinner are 10/- and may be obtained on application to the Secretary, together with price of ticket.

#### TECHNICAL ADVISORY COMMITTEE NOTES

**T.A.C. Executive.**—At the last meeting of the Executive, consideration was given to the purchase of additional laboratory and testing equipment to cover future planning. From several sources have come requests for technical articles of a more practical nature. The Committee appreciate these comments, but would point out, that without the help and interest of the Amateur who has something of a practical nature to offer, nothing can be done at present. The Committee, at the moment, is seeking a practical article on a Ham built amateur-band receiver. Can you help? If so, contact the T.A.C. Secretary, VK3UM, at the earliest. Meeting night is the third Tuesday.

**V.H.F. Group.**—At the last meeting of this group, a chairman and vice-chairman were elected for the current year, 3ACM Col McKenzie filling the chair, and 3XA Don Hope, the vice-chairman. A resume of the recent Field Day was given by 3LS and 3MB (shown in last month's notes as 3NB—our apologies), and it was decided to hold the next field day on the 9th November. 3LS (who has just returned from VK2) indi-

# IRC

TYPE BT  
*Metallized*  
INSULATED

# RESISTORS

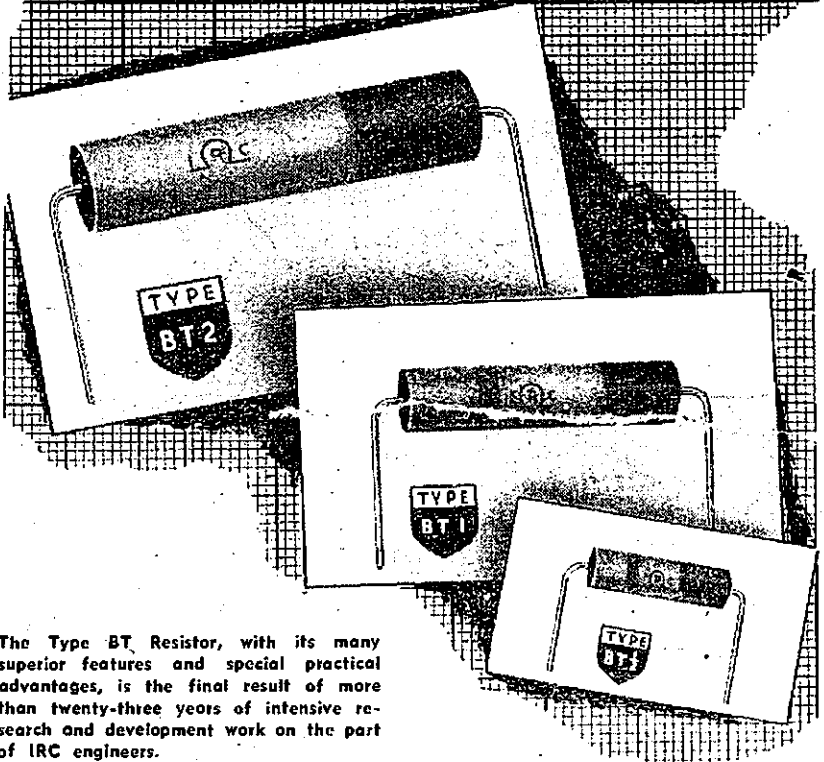

The Type BT Resistor, with its many superior features and special practical advantages, is the final result of more than twenty-three years of intensive research and development work on the part of IRC engineers.

The time-tried Metallized filament principle is retained, but the ingenious construction, firmly based upon sound engineering principles, ensures lower operating temperatures with proportionately higher wattage dissipation in a conveniently small, sturdy light weight, fully insulated unit with an exceptionally low noise level.

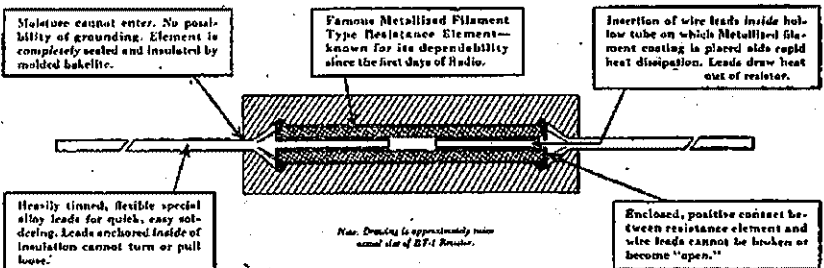

Available in  $\frac{1}{2}$  w., 1 w., and 2 w. sizes  
Sole Agents for Australia:

**Wm. J. McLELLAN & CO.**  
BRADBURY HOUSE, 55 YORK ST. SYDNEY • PHONE BX2508



cated the N.S.W. gang's willingness to co-operate in future field days. This gesture will be greatly appreciated by the VK3 boys. The field day for November would primarily carry out comparative tests on the horizontal and vertical polarisation of V.H.F. antennae. VK3RR then produced a nice looking 168 Mc. transmitter and described his difficulties in its construction, problems associated, and his methods of eradicating the bugs. The next meeting will be held to discuss V.H.F. receivers and converters and everyone interested is invited to bring along his pet. The

meeting night is the second Wednesday.

**Receiver Group.**—Mr. George Neilson delivered a very informative lecture on Crystal Filters and Selectivity in receivers at the last meeting of this group, and will continue on the same subject at the September meeting. A cordial invitation is extended to all. Meeting night is the fourth Wednesday.

**General Meetings of Victorian Division.**—At the October meeting a lecture on Frequency Modulation will be delivered by Mr. H. Kay, of the P.M.G.'s. Department, and Mr. Moriarty will give a lecture at the November meeting on Radiophysics and Propagation.

**Standard Frequency Transmissions.**—These transmissions take place on the 4th Tuesday in the month on the 7 Mc. band and include the Emergency Frequency of 6984 Kc.

**Modulation Technique Group.**—The inaugural meeting of this new group was held to discuss the various aspects and its subdivision into a.m., f.m., p.m., and pulse transmissions. Details will be given next month. The meeting night is the third Wednesday.

**"FOOD FOR BRITAIN" APPEAL.**  
The Secretary of the R.S.G.B. has informed the Committee that parcels are now arriving regularly, and although damaged somewhat in transit, entailing repacking work at the R.S.G.B. HQ, the contents are still in good order. Another 25 parcels have been despatched, making the total 125.

Please make all donations payable to the "W.I.A. Food for Britain Patriotic Fund." You may alternatively contribute to the Fund by buying tickets in any of the following raffles:—

- (3) Oct. 1—A type T1092 transmitter, with second prize of a Taylor T20 triode.
- (4) Nov. 5—A 9002, 9003, 6J6, and 455 Kc. crystal.
- (5) Dec. 3—A Class "C" Wave-meter.

Tickets in each of the raffles are 1/- each, and may be obtained from the Appeal Secretary by postal note remittance. Further raffles are being planned by the Committee, so watch for the details.

Your Zone Organisers are as follows:—N-E Zone, 3YV, Howard Wohlers; N-W Zone, 3OA, I. T. Adams; C-W Zone, 3IQ, Kevin Duff; S-W Zone, 3QC, Bruce Plowman; E Zone, 3QZ, J. G. Colley.

At the general meeting on 3rd September, donations from the box collection was £8/3/10, a very good effort considering the inclement weather and small number present. The raffle of an 813 and socket was won by T. B. Clarke, Chetwynd East, a country member, and yielded a further £8/19/-. The total receipts to the Fund are now £153/12/1, expenditure on parcels £114/14/4, and cash in bank £38/17/8.

The Committee hope to announce

the details of a raffle of general interest soon, so keep tuned to VK3WI for the big news.

#### SOUTH-WESTERN ZONE

Since the last S-W Zone notes appeared there have been two hook ups, viz.: 2nd August and 6th September. For the benefit of those who may not know, our hook up now commences at 10 a.m. on the first Sunday in each month.

In view of the fact that our next Convention is to take place the first week-end in November and details have yet to be worked out, we want a full muster at our next hook up and it is possible a further meeting may be arranged nearer to the Convention date to check up on the number of chaps who will be going and other details.

The winners in the S-W Zone DX Contests were 3HG, c.w. contest, and 3KX, phone contest.

The Ballarat fellows got together this month to work out the details for an emergency communication service and the meeting was very well attended. Those present were 3ALM, 3IV, 3SE, 3BI, 3AJR, 3ARB, 3HW, 3ABT, 3BE, 3ASV. There are some inquiries under way at the moment and when answers to these are received, another meeting will be held and more concrete arrangements made.

We have already been asked to co-operate in a scheme by the local Fire Officer, Mr. H. Elburn, and the sooner some tests are made and exercises carried out the better as the summer is not very far away.

The Secretary (VK3BI) would be pleased to hear from other centres about any activity along this line so it can be given publicity in "A.R."

#### NORTH-EASTERN ZONE

On the Field Day many tests were carried out at Avenel. They were mobile marines, I believe from the amount of water the boys went through. Transmitters were used without antennae and provided good communication two miles apart. A 5" screwdriver was 3UI's antenna and did a f.b. job.

Receivers and transmitters, with and without antennae did good work at the distance and mobile.

Some of the lads heard phone harmonics from aircraft. One announcement stated they were 50,000 feet above Seymour.

Congratulations to Mac, 3XZ, on the arrival of another junior op. —...— 3XZ and 3WR have been busy building a transmitter for 3APB. Final is a pair of p.p. tens. —...— 3YV has a new transmitter in operation and hopes to have details for next month. —...— 3AT was contacted on phone, although his profession is keeping the rig off the air temporarily.

#### WESTERN ZONE

The first monthly hook up, took place as arranged on Sunday, 14th September at 10 a.m., a good roll up

# Low Drift Crystals

FOR  
**AMATEUR  
BANDS**

ACCURACY 0.02% of  
STATED FREQUENCY

3.5 M/C and 7 M/C

Unmounted .. £2 0 0

Mounted .. £2 10 0

12.5 and 14 M/C Fundamental Crystals, "Low Drift" Mounted only £5.

Spot Frequency Crystals  
Prices on Application

Regrinds .. £1 0 0

THESE PRICES DO NOT  
INCLUDE SALES TAX.

## Maxwell Howden

VK3BQ

15 CLAREMONT CRES.,  
CANTERBURY, E.7.

of members resulting. Those present being 3GN, 3ATR, 3YW, 3TA, 3EP, 3AGB, 3AKW, with 3AKP coming in late at the mike of 3YW.

A lengthy discussion took place in reference to conventions and field days for members of the Zone, and the general feeling seemed to be that more field days and less conventions would be of greater ultimate interest and benefit to members.

The subject is to be put on the agenda of the next convention to be held on the second Sunday in November at Maryborough, where the matter will be fully discussed and possibly a 50 Mc. field day arranged.

Interest in 50 Mc. work is definitely on the up-grade in the Zone and we should have a reasonable number of sets in operation before very long, so maybe you chaps in Melbourne will be turning your beams to the west before very long.

3GN went to Ballarat for the last 50 Mc. field day and came home heavily infected with the virus, so George is now busy with a 50 Mc. receiver and plans to do some 166 Mc. work as soon as Kevin Duff gets his call. 3GN has a parallel line osc. using a pair of CV6s. Also is putting his Type 2 Mark 3 permanently in the rack as an exciter for the 809s on the lower frequencies. — — — STA puts out a tremendous signal on 7 Mc. Sounds like 500 watts instead of 50, however Byron spends most of his short time on 14 Mc. these days, not so much QRM (wise guy). Byron is active on 50 Mc. and, in company

with Claude (3WC), should keep Horsham on the H.F. map.

3EP still puts out an excellent phone on 7 and 3.5 Mc. That P.M.G. mike of his certainly does a good job, not so much local noise on 7 Mc. Ted, but still the QRM is worse than 3.5 Mc. — — — 3AGB has been QRL, very much so: Not much radio to report, but by sounds of it there will be something doing in Horsham before long (look out Byron). — — — 3AKW puts out an f.b. sig. You are the best of the gang to get through the racket on 7 Mc. Bill.

3DP is still pounding away on c.w., but will be putting out phone soon, so that means more QRM, but why not, everybody's doing it. — — — 3ATR is putting up V beams, so now the DX had better rewind their receiver coils with heavier wire. Nice phone you have Trev. — — — 3HL is very busy at present, had a house full for the holidays and now a fist full with shearing. However Allan still finds time to work a few Gs. — — — 3AKP's new QTH is not so hot. Line voltage lousy, official complaint to powers that be resulted in a new line being installed from the tranny and reports f.b. supply now. Keith works at the power house, say no more. — — — 3YW overworked trying to get something for these jolly notes. However is also suffering from acute six-meteritis, but is still in the theory stage. Don't suppose it will be long now.

Western Zone members please note:  
(1) Zone hook up on second Sunday

in month on 7050 Kc. (2) Next Zone Convention will be at Maryborough on second Sunday in November.

### N-W ZONE CONVENTION AT KERANG

The small Ham population in the many thousands of square miles which constitute the N-W Zone is grouped mainly around Mildura and Kerang, which two centres are separated by nearly 200 miles of roadway. Attempts to get together having been defeated by the transport problem, the Kerang gang rallied around their key station 3TL and held their 1947 Convention in Kerang on 13th September.

The attendance was good when it is considered that the nine members who came along did a total of 560 miles of travelling for the day. Those present were VKs 3TL, 3OA, 3CE, 3HR, 3BM, "Bud" Page, "Chas" Stanford, "Wally" Loneland, Austin Morse and Vincent Trebilcock.

After lunch the gang called on 3OA and, having inspected the fine shackful of gear he has assembled in the few months he has held a ticket, we decided to up-end the 3 element 14 Mc. rotary beam on a forty-foot steel mast that was lying there ready for erection. It proved a lot tougher assignment than we had anticipated, but when finally Ham brains and brawn triumphed, the profusion of sweat was out-matched by the profusion of Ian's gratitude.

The thirsty gang then turned up at 3TL's in time for afternoon tea.

## RED LINE EQUIPMENT for the F.F.R. AMPLIFIER

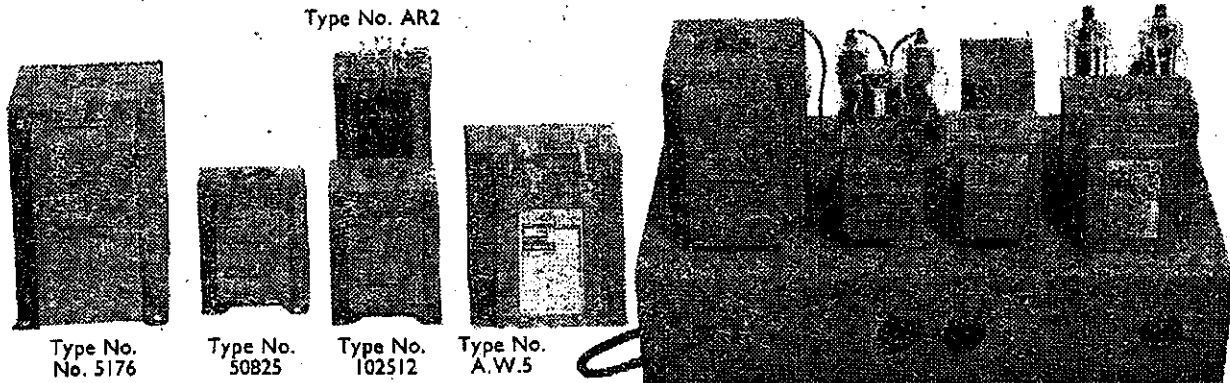

### RED LINE EQUIPMENT FOR THE AMATEUR INCLUDES:

- \* High Tension Plate Transformers.
- \* Low Tension Filament Supplies. (Insulated up to 4000 volts if required).
- \* Class B Driver Transformers.
- \* Multi Impedance Modulation Transformers.
- \* Heavy Duty Power Supplies.
- \* Swinging and Smoothing Chokes
- \* Wide Range Audio Equipment
- \* Frequency Dividing Networks

# SWALES & SWANN

Technical Service,  
Wholesale and Manufacturers:

A. T. SWALES, Cent. 4773  
2 Coetes Lane, Melbourne.

Trade Sales: ALLEN SWANN  
MU 6895 (3 Lines)  
157 Elizabeth St., Melbourne

Mrs. Treb's teapot was worked overtime and greatly appreciated. Having looked over 3TL's elaborate rig, which he truthfully claimed was the only one of its kind in the world, we settled down to the business.

3TL was elected President and key station; 3OA, Secretary-Treasurer and Food for Britain Organiser; 3BM, Mag. Correspondent and Publicity Officer. These three and a member, to be nominated by the Mildura gang, are to constitute the N-W Zone Committee. A long file of apologies and good wishes was received.

The N-E Zone motion that Zones collect W.I.A. Annual Subscriptions and deduct 2/- for local Zone expenses was unanimously negated. During this discussion appreciation of the good work being done by honorary workers at headquarters was freely expressed, also the hope that a paid Secretary will be appointed, even at the cost of increased subs. The fine job being done by the Disposals Committee was commented on, the only criticism being that a fuller description of the goods on the application form would be appreciated.

VK3WI and the broadcasts were favourably mentioned. The idea behind the appointment of the Zone Publicity Officer was to try, through 3WI, to keep in closer touch with the doings at headquarters and to promote there a better understanding of our needs and problems.

The Magazine came in for both bouquets and brickbats. The general idea was expressed that the technical articles, with notable exceptions, were too high brow and mathematical; a more practical and popular type would be preferred. We would like to see more station descriptions and personal paragraphs as in the pre-war magazine.

It was decided to have only one Convention per year, but to endeavour to arrange for a party of our members to visit the Conventions of adjoining Zones.

After contributing generously to the Food for Britain Appeal, the gang settled down to hear an informal talk by 3BM on "The Cathode Ray Tube for Ham Use." The speaker endeavoured to show how a simple five inch job for modulation checking could be built at a cost of less than £10 from Disposals equipment to work from either a.c. or batteries.

After dinner the gang inspected the Kerang power house and then adjourned to 3BM's shack, a mere 27 miles away. There the technical talk was followed up by a demonstration on the c.r.o. After examining the gear and various home-made electrical devices and sampling the XYL's supper, the gang set out in various directions for the long drive home.

3HR is busy servicing 'dozers, graders, etc., for the C.R.B., but puts out a good signal on 3.5 and 7 Mc. —...— 3CE recently installed an

807 in the final which promptly developed every sort of bug. Mostly on 3.5 Mc. Roy uses batteries and genemotor. —...— 3TL is about to erect a 28 Mc. rotary. We can only guess at what Treb said when he built his 28 Mc. Tx around an 815 (not haywire, either!), only to find the 815 was a dud and unreplaceable. —...— 3OA will soon be on 14 Mc. with his new rotary. Has a yard full of antennae and more planned.

3JG is too busy with a bumper citrus crop for Ham Radio. —...— 3LU is developing a No. 11 set into an f.b. eight tube super. Puts out a very nice phone signal on 7 Mc. Has been an experimenter since 1922, but only recently took out a ticket. Operates for the P.M.G. at Sea Lake. —...— 3ZK hopes to stage his post-war comeback soon. —...— It is rumoured that Alf, of 3CH, may stage a comeback! —...— 3BM is gradually getting the gear together again and the antenna systems up so far are 7 and 3.5 Mc., but will be on 14 and 28 Mc. soon, then will tackle 50 and perhaps 166 Mc. with the co-operation of 3OA and 3LU.

The Northern gang is on every Sunday morning on 3.5 Mc. at 0930. All welcome, call the key station, 3TL.

## QUEENSLAND

Secretary: R. Thorley, VK4RT, Box 638J, G.P.O., Brisbane.

Meeting Place: State Service Building, Elizabeth Street, City.

Meeting Night: Last Friday in each month.

The general meeting of the above Division was held at the State Service Rooms on Friday, 29th August. Owing to the unavoidable absence of the President (VK4AW), the chair was filled by Vice-President 4KB. The winners of the City-Country Contest were announced, 4TY for the City, and 4ER and 4HZ tying for the Country. Prize money of One Guinea per person per win has been forwarded. Congratulations to the lucky people concerned.

Speaking of guineas, applications have been invited for a new QSL design for 4WI, and a prize of that amount will be paid to the originator of the winning design. The scheme has received quite a bit of publicity over 4WI, the closing date being 25th September, so if you haven't heard and would have liked to enter, we are sorry, but it really pays to listen to 4WI.

Indignation of a high order was expressed by several members (others probably muttered under their breath) at the proposed cut in Amateur Frequencies. At the time of writing we have not had any official advice, but the A.R.R.L. would hardly have put the news over unless it was the good oil (or bad oil). It was moved that a protest be for-

warded to Federal Executive, to see if something might possibly be done before the decision is ratified. News of a happier type was to the effect that approximately £15 of food parcels have been sent away to G land, but further donations are urgently needed. Just ask yourself in all seriousness, how do you expect the Gs to erect rotary beams, etc., and stay up nights working you fellows if they aren't adequately nourished. Thank you, send your donations to VK4FN, Dawn Street, Stafford Heights, Brisbane. All amounts re-

## SPECIALS! WHILE THEY LAST

O—5 Amp. Thermo  
Ammeters, 17/6

### METER SCALES

Suitable for Pullin "Disposal" meters. Volt-M.A.-Ohm or special Multi-meter scale.

Either type, 2/-, post free.

### POWER TRANSFORMERS

Wound on extra large core. Any voltage or amperage—Reasonably priced.

### 7-DAY DELIVERY SERVICE

Multi-Match modulation Transformers. 75-watt. In die-cast metal clamps. Write for full details. £4/19/6. DELIVERY EX STOCK.

### CHASSIS — RACKS — PANELS

Any size, any gauge. Write enclosing full particulars. Quotation forwarded by return mail.

VK3NU

## Major Radio & Electrical Co.

189 GLENFERRIE ROAD,  
MALVERN  
WM 1814 U 9354

ceived, however large or small, are treated as confidential.

The editorial "we" must be dropped for a moment, for me to announce that the general meeting saw fit to bestow on 4ZU the position of sub-editor of "Amateur Radio" for this State. Thanks fellows and I shall endeavour to give of my best and further the cause of Ham Radio, in whatever way possible. Part of the job is to collect articles for the magazine, so really you all have a part to play, and any assistance or suggestions in that respect will be very much appreciated. Frank Nolan, VK4FN, has kindly promised to act as assistant in the compilation of notes, etc.

Quite a highspot in the proceedings last general meeting night was the auction sale of apparatus donated by members to the Division, and also some for private sale. "Gus," 4XG, played the role of auctioneer, and if any talent scouts from the big firms were around we wouldn't be surprised to hear of "Gus" taking a new job any day now. After all it would be a change to go to a Disposals Sale and hear the auctioneer extolling the virtues of a transformer, which obviously is a tranny, instead of some of the weird specimens held up at recent sales. The affair netted the Institute a princely £14, and typical of the good buys was a Jap 813 which was knocked down for 7/6.

Membership of the Queensland Division is approaching the 150 mark, the highest ever, and conspicuous among the new men are quite a number of associate members, would-be Hams, who evidently are attracted as a result of 4W1 broadcasts. The distribution of "Amateur Radio" seems to have improved of recent months, and few complaints are received. One member, VK4HD has been missing out rather consistently however and would like the magazine people to check up.

We hear that Eric Lake (4EL) has now worked a total of 1,005 Gs. Of 518 contacts since January (G contacts) 310 have been new contacts. Eric will be remembered for the infamous treatment he used to mete out to the 45s in the final in pre-war days. The 45s are no more, the first post-war rig being an 801 (tritet on 3.5 Mc., doubler, etc., to 14 Mc.). On 28 Mc. the rig comprises a 6J5, 6N7, 807 exciter (a la the Handbook), driving a pair of 801s. The present rig starts off with a v.f.o., actually the r.f. section of a 208, driving the 6J5 in the above exciter, and an 805 in the final. A hambrew super and the same old 4EL standby, the vertical antenna have netted Eric 134 countries post-war, which methinks is quite a solid effort. Having worn out umpteen bugs, 4EL's latest baby is an Electronic Key.

On Friday, 12th September, the Council packed its bags and journey-

ed to Ipswich for the express purpose of holding a Council meeting in that City, at the home of VK4KO. A pleasant evening was had, the Ipswich gang being present in force, to see what makes the W.I.A. tick. Apologies were received from Councillors Nolan and Neale, both of these chaps being on shift work. Ipswich Amateurs present were 4KO, 4WS, 4MW, 4CH, 4FW and 4ZB.

To assist the librarian (4LT) in his job, a system of zones has been set up in the State, and to assist the running of the Ipswich Zone, 4WS offered to act as Zone Manager for that section. Other Managers are 4HZ, Central Zone; 4HK, Tablelands; 4SN, Southern Zone; and 4EJ, Townsville. News from these men will be found else-where in the notes.

Treasurer 4ES suggested that a field day embracing the Ipswich men might be a good idea, and it is proposed to run one about the 12th of October, and at the same time to run 50 Mc. tests for the benefit of those who are interested. It has long been the wish of the Brisbane gang to have a Brisbane-Ipswich link on 50 Mc. and we hope things may develop before too long.

Regarding student classes, 4KB, in answer to a question, explained the position in regard to rooms, lectures, etc., and the impracticability of doing anything at present, but speaking in support of Pat, 4AW said that it was hoped to do something about the matter in 1948.

At the conclusion of the meeting, President 4AW thanked Norm Hart 4KO for the cordial welcome extended by the Ipswichonians, and expressed the wish that reciprocal visits might be made. Thanks are also due to Mr. and Mrs. 4KO for refreshments served. Council, comprising 4AW, 4ES, 4KB, 4SN, 4FJ, 4LT and 4ZU departed for Brisbane at approximately 11.30 p.m.

#### CENTRAL ZONE

4LN, at Gympie, is active on 50 Mc. Barrie is running calling-and-listening periods at 0700-0715 and 1900-1915 daily. The antenna sits atop a 110 ft. pole. — 4XR is using a pair of 809s, grid modulated. He is an operator at 4GY. — 4HZ uses e.c.o. and Philips No. 4 receiver. Heard on 3.5 Mc. a lot. 4PG got amongst the VK3s on 27th July using a four element beam. — 4AD getting among the Ws on 7 Mc. c.w. — 4XJ is busy erecting a new antenna. Will be on phone shortly.

#### TOWNSVILLE ZONE

4EJ is having a busy time with 14 Mc. DX. 4QA is another 14 Mc. signal heard consistently at VK4SN.

#### SOUTHERN ZONE

4CU uses a three element beam and he worked six of the 12 VK3s heard on 27th July. Was heard by VK7XL at S8. — 4SN worked eight VK3s on 27th July using a vertical dipole. Is keen on getting his

W.A.S. (American) soon, only a couple of States to go. — 4KK also on 50 Mc. and was in the VK3 "party" on the 27th. — 4ER worked all Brisbane in the Contest. Eric is on 7 Mc. phone in the early mornings. — 4UX is putting out strong phone from Stanthorpe these days. Is on 7 Mc.

## SOUTH AUSTRALIA

Secretary: E. A. Barbier, VK5MD,  
Box 1234 K, G.P.O., Adelaide.

Meeting Place: 17 Waymouth Street,  
Adelaide.

Meeting Night: Second Tuesday of  
each month.

The monthly general meeting was held on Tuesday, 9th September, when Mr. Ted McGrath (VK5MO) gave an interesting lecture on "Some Aspects of Modulation." Many country visitors were present and also took the opportunity whilst in town for the meeting to visit the Royal Show, ho hum! Among the visitors were Messrs. Hancock (5RJ, Kadina), Wallbridge (5UX, Kadina), Hodgson (5AP), Peters, Brice, Martin, Hughes, Glover (Ponde, River Murray), Tregenza and Bell (Maitland).

Mr. McGrath (Ted to you) opened his lecture by alluding to the big responsibility which is carried by all phone Amateurs to see that their signals are as near perfect as they can be, because although it may only be a hobby, the powers that be who hear the signals we emit may one day take away our hobby if we do not radiate as pure a phone signal as we can. Phone signals being of such a complex nature are more likely to be faulty than are c.w. signals, thus most of the bad emissions on our Amateur frequencies come from badly adjusted phone stations.

The three main causes of bad phone signals may be divided into over-modulation, distortion and noise. The remedy for overmodulation lies either in turning back the gain or fitting some form of peak limiter which, however, brings in its train some form of band pass filter to bypass the harmonics generated by the clipping of the original frequencies. The remedies for distortion are too familiar to all to bear repetition and inherent noise and hum, the third main cause of bad phone, have been encountered by any amateur who has tried his hand at phone work.

Ted illustrated his remarks at all times on the blackboard, which fortunately for me, but unfortunately for the country reader, somewhat cramps the re-write. I might add that Ted did not introduce into his lecture anything that we have not read in the standard text books, but it is remarkable how much easier it is to appreciate the spoken instruction rather than that given in text books.

Judging by the intelligent ques-

# A.G. HEALING

LIMITED

MANUFACTURERS AND  
DISTRIBUTORS FOR . . . . .

Electrical and Testing Instruments for all purposes made to British Standard specifications. Each instrument is accurate, + or -, to 2 per cent., and parts are heavily plated to prevent corrosion even under tropical conditions. "Healing" Electrical Meters equal the best imported types and will give accurate service for long periods under the most exacting conditions.

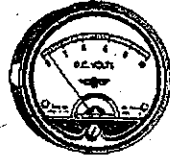

No. 10A round production mounting Black Bakelite Case.

Type No. 30A 4" square semi-flush Black Bakelite Case.

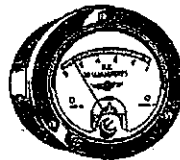
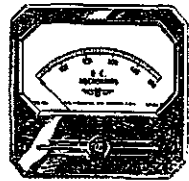

No. 20A 2½" round flush mounting Black Bakelite Case.

These, and all other Healing Radio Electrical Testing Units, are manufactured in our own factories and available from A. G. Healing Ltd.

OTHER INSTRUMENTS INCLUDE:

Oscillators — Multi-Testers — Signal Tracers, etc.



ALSO MANUFACTURERS AND DISTRIBUTORS FOR

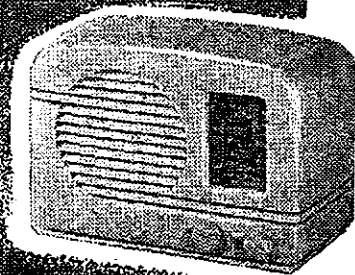

## Golden Voice RADIO

A. G. HEALING LTD., Melbourne, Sydney, Adelaide  
WESTERN AUSTRALIAN DISTRIBUTOR: Cloak's Household  
Utilities, 85B High Street, Perth BRISBANE REPRESENTATIVE  
H. K. Lane, Basement, A.M.P. Building, Queen Street, Brisbane.  
TASMANIAN REPRESENTATIVE: C. J. Irvine, P.O. Box 375,  
Launceston.

H.F.P.

Amateur Radio; October, 1947

tions at the close of the lecture, it was appreciated by all present and Mr. Les Sawford (VK5LF) proposed a vote of thanks in a voice which had a definite resonant frequency round about 30 cycles and would be, I should say, one of the deepest voices ever to be heard at an Institute meeting.

Jack Coulter (VK5JD) arrived a little late and immediately launched into a long discussion with me on how rotten these notes are and how in VK3 they do things a lot different, "ad infinitum." If Jack ever gets off my back I will be somewhat lacking my usual spur and probably turn in some good copy for once. What do you say Jack?

Attendance figures were down at the meeting, probably due to the counter attractions at the Royal Show. Although it was still a good attendance, some 80 odd, we are becoming somewhat blasé these days and call anything less than 100 members a poor attendance.

Judging by the disappointed looks on the "wolves," the non-appearance of our only lady visitor upset some calculations and apparently some hair oil and new ties were entirely wasted.

Radio Amateurs were highly amused this week when Shirley Tracey, a 19-year-old girl from N.S.W., billed at the Royal Show as "Electra, the high frequency girl, who shocked a nation," received an electric shock in her tent after a performance and was subsequently admitted to the Royal Adelaide Hospital. Something akin to the jockey, who fell off a rocking horse!

In reply to the many telegrams, telephone calls and messages of congratulations to 5PS on his being heard on 50 Mc., he would like to say that it was no trouble at all. The sequel to this big event is that an 807 valve, which will cost the winner 25/-, will be given to the Amateur who can explain why 5PS was on duty at a commercial broadcasting station and yet was heard in a round table QSO on 50 Mc. at the same time. No mirrors were used and no rig was used by 5PS. You whistle and we will point.

They say that one can become used to anything if it is persisted with long enough, and apparently this is so because it has only just become apparent that "Count" Jack Strafford (VK5JS) has been missing from the air for some time due to a trip to the "bush" on business. We were so used to hearing Jack that we never missed him. Welcomed back.

A newcomer in Wykeham Bailey (VK5WM) is busy knocking over the DX on c.w., but is complaining about the QRM on 14 Mc. He said it is very discouraging. Wouldn't it!

Jack Lester (VK5LR) has moved to his new QTH at Brighton and is at present going around at night with an axe looking for any mast higher than twenty feet in the vicinity of

his shack. Survival of the fittest is the motto at Brighton.

Ross Harris (VK5FL) is back from a trip to VK3 and full of news of bargains available. Don't know just how much he brought back but isn't it marvellous how these Council chaps get on to the bargains. Despicable I call it, by the way Ross let me know next time you go, I could do with a little gear. Despicable, isn't it.

The new W.I.A. badges were available at the meeting and the general opinion was that they were a good job and would practically sell themselves. Quite a few members were comparing them with their old badges and all admitted the vast improvement in the new one.

Several members have suggested that this magazine could well include a "Hints and Kinks" column after the style of QST. I pass it on for what it is worth. (Some "Hints and Kinks" would be appreciated; let us have them.—Editor.)

Conditions on all bands in VK5 this month have been only fair and a couple of "Aurora Australis" did not improve things. Some peculiar effects were reported on 50 Mc., such as hearing a BBC foreign language broadcast for one to two hours straight and some odd W signals which however faded out too quickly to be deciphered. As these reports came from very reliable sources it gives one something to think over.

With such a large number of new Hams these days attending the meetings it is a good idea for the QSL officer to distribute the QSL cards as he does at present, thus making the Hams stand up and thereby become known to the rest of the gang.

#### NORTHERN TERRITORY NEWS

Activity in Ham ranks is increasing and at times QRM is heavy, but nevertheless it is good to see the chaps getting going. 14 Mc. is the favorite hunting ground.

Most active is Jack Pickles, VK5QV (ex-VK2QV pre-war). Rig is 6V6-807-807s parallel, 70 watts input and half-wave doublet has accounted for working of 37 zones. VK5SA, Bill Symons, has nice signal from 6V6 tritret 807-809 final. Full wave zep on 14 Mc. is radiating end of the business.

VK5KL, Clarry Castle, active as usual on 28 and 50 Mc. After recent achievement in two-way contact with W7ACS/KH6 on 50 Mc. is keeping close watch on that band.

VK5CN at Berrimah is doing nicely on 14 Mc. using 6V6-807-807s parallel. Jack Marr, VK6AJ, fixed portable has been inactive for several months. Showing signs of building a 50 Mc. converter.

Noel Roberts, VK5NR, at Katherine (Voice of the North) shifting QTH to Darwin. A newcomer in Syd Morris, VK5AB, should be active shortly. 6V6 and 807 to start with, will be the line up. VK5AV, George Birm-

ingham is inactive. Receiver trouble is main cause.

Hillery McGrath, VK5AZ, will be some time before on the air. Has to build up from scratch. Nothing heard of VK5KI at Tennant's Creek. That is all now gang. Don't forget we will appreciate a call and yarn anytime, so note the above calls.

Thanks to VK5KL we are able to publish these notes from the "Forgotten Heart." We would like to hear of your doings regularly—Editor.

## WESTERN AUSTRALIA

Hon. Secretary: W. E. Coxon, VK6AG, Howard St., Perth, W.A.  
Meeting Place: Builders' Exchange, St. George's Terrace, Perth.  
Meeting Night: Second Monday in each month.

The September meeting fell on the 8th, and was well attended. The following members being present:—6KE, 6HL, 6LW, 6DF, 6RU, 6YZ, 6DJ, 6WT, 6JB, 6MB, 6TX, 6MY, 6FR, 6WH, 6AS, 6GA, 6GD, 6PW, 6FW, 6RB, 6RJ, 6SA, 6WW, 6GB, 6HM, 6RG, 6DN, 6RO, 6BG, 6LM, 6LS, 6RF, 6EV, 6EP, 6KB, 6DD, 6AG, 6GM, 6WS, 6JS, 6FL, 6KW, 3KU.

Among those present was VK3KU, Howard Love, who has been making a brief visit to VK6, and J. N. Paris, from VK5.

The membership of this Division is steadily growing, a few of our W friends who have settled in VK6 being among the new members.

Availability of certain Disposal material was discussed, and members were given the opportunity of ordering.

The evening was then given over to Lecturettes. 6DD had a Bendix Wavemeter built into an exciter unit for his new rig, which created considerable interest. 6SA gave a talk on WWV Schedules and how to apply the transmissions for calibration of Wavemeters. 6LW finished the evening with the first portion of his Lecturette on Frequency Modulation principles.

This was enthusiastically received, but unfortunately, could not be concluded owing to the lateness of the hour. Wally will be continuing at the next meeting.

#### PERSONALITIES

6MW, consistent DXer at North Beach, seems to have changed from his former "rotary beam" mindedness, to a long wire antenna enthusiast. —...— 6GM during a recent stay in hospital was heard on 7 Mc. with his "suit case" portable. We think George is gradually getting "bitten with the bug" again. —...— 6AG now a "country" Ham at Darlington, often heard on 7 Mc. phone. —...— 6LM is a stalwart on 7 Mc. with a f.b. signal. Keep the band warm Lionel. —...— 6RU is now heard again day and night with his new array, motor driven. Jim has dispensed with his three element close spaced beam and now has a

three element wide spaced. —...— 6X1 pays Perth periodical visits and lets us know how Northam is being kept on the Ham Radio map.

6CM has been heard quite regularly lately both on 28 and 7 Mc. Modulation is good and Bill seems to be doing a fine job. —...— 6DX, of Bolder fame, is often heard on 7 Mc. We don't know what activities are conducted on other bands though. What about some Goldfields news? —...— 6KW is another three element wide spaced 28 Mc. fan. Ron reckons results are far superior on this array to his previous four element close spaced beam. —...— 6IG one of those silent "Tremantle-ites." No one knows these days what goes on in our Port. What about letting us in on it lads? —...— 6DF is reported working very hard on a new transmitter for V.H.F. Maurie has been listening on 56 Mc. quite a bit and soon should be heard down there with possibly F.M. as well as A.M. —...— 6BC found that little strands of wire can cause some funny things to happen. Bert was "off the air" with a silent carrier, when one of these little strands of wire shorted out the modulation transformer recently.

6AP has gone tower minded. We believe Alf will soon have a tower erected with the necessary beams adorning the crown. —...— 6EV is temporarily absent from the higher frequencies, owing to receiver trouble. Don't delay too long John, as 28 Mc. is coming good. —...— 6FL has been working some nice DX on 28 Mc. lately with his new two element close spaced beam. —...— 6DD's rebuilding efforts seem to be progressing favourably judging by the new exciter shown at the last meeting. —...— 6HL has been experimenting with his arrays and obtaining some queer, but interesting, results.

During this last month conditions have shown a decided improvement over what they have been previously. Both the 14 and 28 Mc. bands being quite lively.

28 Mc. Phone—Europe.—Quite a few of these boys filtering through from 1800-2000 fairly consistently. G5DF, G6TD, G2IG, G6GO, F3HM and 11Y making good QSOs.

Africa.—Contacts with this Continent are becoming like local QSOs, particularly ZS. Some have put signals well over S9 in here, afternoon after afternoon lately, and many old acquaintances from last winter. ZS2BS, ZS2CI, ZS6IH, ZS1CG, ZS5AW, ZS6CM, ZS6GN, ZS5BY, ZS6EV were all f.b. signals, while VQ4NSH, VQ5ELD, ZE2JA, and our old stalwart SUIHF were all enjoyable QSOs.

Asia.—The VU boys are gradually thinning out these last few months as most of them were Gs, and consequently gone home to England. A few in the form of VU2LR, VU2BF and VU2AJ are still left and may be

heard almost any day and sometimes up to 2200. CR9AG and ZC6RG were two nice contacts apart from the J2 and J9 boys who are too numerous to mention.

14 Mc. Phone—Europe.—This Continent has not yet broken through in the late evenings, but quite a few signals have been heard from 1400-1700, that is providing one can beat the QRM from VK2 and VK3. G4MS was the only contact made.

Africa.—Conditions have been quite fair in this direction practically any evening from 2100 onwards and should improve still further as the summer months draw closer. WD6DT, from Nyassaland, who must be the most sought after Ham in this dark Continent, was a good QSO, while ZS6HW and ZS5M from the Union and ZE2JG, Southern Rhodesia, were the best contacts.

Asia.—All the usual J, C, KA, and VS birds seem to pound in nightly at terrific strength no matter which way the beam is turned. J8AAB and J8ASC, from Korea, were the two best catches.

North America.—The Ws still are one's best bet nightly, and contacts are too numerous to mention. From Canada a few signals have been very good, the two best QSOs being VE4KF and VE3HI, the latter being worked due south from here.

Central America.—Some nice DX has eventuated from this area lately and these boys are always welcome QSOs. VP9F is getting very consistent on the high end of 14 Mc. band about 1730 daily. NY4CM, XE1FY, XE1RO and CO2KO were all fine contacts.

South America.—A few strays have appeared in the early evenings, but the only ones worked by VK6KW were HK1FQ and HK1BE.

## TASMANIA

Secretary: J. Brown, VK7BJ  
12 Thirza Street, New Town.  
Phone W 1328.

Meeting. Place: Photographic Society's Rooms, 163 Liverpool Street, Hobart.

Meeting Night: First Wednesday of each month.

The re-building programme mentioned in last month's notes is still continuing, however most members state that their jobs are nearing completion and already quite a lot of good DX has been worked.

7DS has at last cleared the bugs out of his signal and he is now a far happier man. Hugh spends a lot of his time on 7 Mc. and he tells me that there is some good DX to be had on that band.

7BQ has successfully completed his 50 Mc. rig, together with a three element beam. At the time of writing these notes final adjustments are being made with the help of Perc Crawford, the "converter king."

7RK now has another antenna, this time it's a single wire fed matched

impedance. By the way Ray is working the Europeans, it looks as if this antenna may be the answer to his prayers.

7GD is now collecting parts prior to building up a transmitter. Geoff came staggering into BQ's shack a few days ago with a power transformer so large that Len dashed outside to see if he had brought the lamp pole as well.

7JH at Waddamanna writes in to say that DX is good up in the lake district and that 7XA has talked him into going on phone. Jack goes on to say that he was QSOing, G5LI and George wanted to know where 7LZ was. He evidently doesn't know that 7LZ only works Europe once a year. We have sent George a food parcel to keep him alive until next September.

This month we welcome back on to the air two real old timers. Jack Wallace (7JW) and Ern Cooper (ex-7MK and now 7MC). Both Jack and Ern are starting on 7 Mc. and both are using phone.

Nothing has been heard of 7TE since he renewed his licence, however news via the grapevine states that Bill is at present building a 166 Mc. transmitter.

## A Wide Range Crystal Filter For 455 Kc

(Continued from page 8)

It is important that the b.f.o. should be set to the correct frequency. This can be checked by tuning in a signal on the nose with the b.f.o. switched off. The b.f.o. should then be switched on and its frequency adjusted to give the desired pitch. In c.w. reception with the crystal at its sharpest, only the desired beat will be obtained, all other beat frequencies being very much weaker, and that beat will only be obtained on one side of zero beat and not both sides as with usual degrees of selectivity.

## FOR SALE, EXCHANGE, WANTED

9d. per line, minimum 2/-

**WANTED TO BUY.**—QST for February, 1936. Must be in good condition. VK2PV, 44 Bradley's Head Road, Mosman, N.S.W.

**WANTED TO BUY.**—Disposal Crystals, any quantity, preferably in the 4.5 to 6 Mc. range and in small octal type holders if possible. W. J. Scarff, 7 Glenview Av., Malvern, Vic.

**WANTED** Modulated Oscillator, will exchange ten tube communications super, xtal filter, 1,500-18,000 five bands, 110 volt, a.c. Write VK9KT, Daru, via Port Moresby,

**WILL EXCHANGE** AR8 Communication Receiver, good working order with 6V6G and Speaker fitted for an AR7 Receiver. VK3ABT, E. Lloyd, 122 Drummond St. South, Ballarat.

# R

adio  
adio  
adio

★  
For The  
Amateur Broadcaster

★  
ADIO PARTS From

**LAWRENCE & HANSON**  
**ELECTRICAL PTY. LTD.**

THE MOST SELECTIVE, MOST RELIABLE,  
MOST SATISFYING RANGE ANYWHERE!

We've said it before . . . it's worth repeating now—why look all over the city for your radio parts and components when you can get the BEST for your money with

LAWRENCE & HANSON  
RADIO PARTS

The high quality radio components from L. & H. are guaranteed always dependable . . . reliable and built to give long years of faithful service.

If you're re-fitting out your old transmitter or receiver or just adding something new and modern, look up the list of L. & H. Radio Parts.

Latest lists and prices are available from your radio house. When in doubt about what and where to get parts for your set, ask the chap next door or the fellow enthusiast down the street—he'll recommend Lawrence & Hanson Radio Parts—everytime!



- ★ Microphones
- ★ Batteries
- ★ Switches
- ★ Vibrators
- ★ Chokes
- ★ Condensers
- ★ Coils
- ★ Meters
- ★ Valves
- ★ Transformers
- ★ Chasses
- ★ Speakers

Technical Advice  
given on request.

**LAWRENCE & HANSON ELECTRICAL** Pty. Ltd.

33 York Street, Sydney.

120 Collins Street, Hobart.

87 Elizabeth Street, Brisbane.

172 William Street, Melbourne.

60 Waymouth Street, Adelaide.

20 Paterson Street, Launceston.



HEADQUARTERS FOR AMATEUR EQUIPMENT

TYPE S14

Retail Price 5/-



TYPE S13  
Retail Price 4/9



TYPE FT 4  
Retail Price 6/9



**AEGIS CERAMICS**

Vital little pieces of equipment which proved worth their weight in gold to the Services, these Aegis Ceramics are available right now to the Ham! The range is complete and every one is typical Aegis quality . . .

TYPE S12  
Retail Price 2/6



TYPE FT 2  
Retail Price 4/7



TYPE S12A  
Retail Price 2/9



TYPE FT.1  
Retail Price 3/9



TYPE GT 2  
Retail Price 8/3

TYPE BH 2  
Retail Price 5/10

Attractive Discount to Licensed Amateurs.

**J. H. MAGRATH & CO.**

Distributors of Aegis Components : 208 Lt. Lonsdale Street, C.1.

# AMATEUR RADIO

NOVEMBER

1947

JOURNAL OF THE WIRELESS INSTITUTE OF AUSTRALIA



*full steam  
ahead*

TO BETTER RADIO

with

**PHILIPS**  
*VALVES*

PHILIPS ELECTRICAL INDUSTRIES OF AUSTRALIA PTY. LTD. Sydney, Melbourne, Perth, Adelaide, Brisbane



FOR THE EXPERIMENTER & RADIO ENTHUSIAST

Registered at G.P.O., Melbourne, for transmission by post as a periodical.

**6d.**

# *These Kingsley Products are making Radio History!*



## **KINGSLEY**

### **K/S 9'er SIGNAL BOOSTER**

Since its introduction a few weeks ago, the KS/9 signal-strengthening unit has attracted a lot of interest. Kingsley engineers thought they had something pretty good but it is even better than they thought—and that is something to take notice of. Kingsley's new production programme is a busy one and leaves room only for the best and most useful products—so, for the very best in radio equipment—keep your eyes on Kingsley.

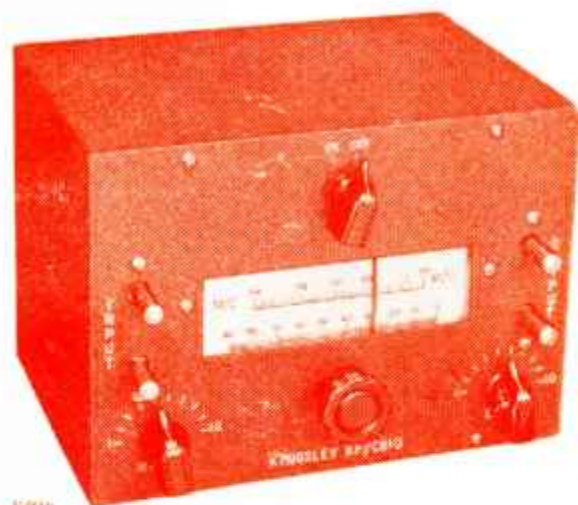

## **KINGSLEY**

### **SHORT WAVE CONVERTER**

This unit in its complete form serves as a medium to increase signals from amateurs transmitting on the 50/54 M.C. Band (6 Metres).

Lined and adjusted and ready for immediate use.

*Complete installation and circuit details of both units are obtainable on application.*

KP10



# **KINGSLEY RADIO**

**KINGSLEY RADIO PTY. LTD.**

**380 St. Kilda Road, Melbourne, Victoria . Phones: MX 1159, MX 3653**

# AMATEUR RADIO

*Published by The Wireless Institute of Australia,  
Law Court Chambers, 191 Queen Street,  
Melbourne, C.1*

**Editor:**  
T. D. HOGAN, VK3HX.  
Telephone: UM 1732.

**Technical Editor:**  
J. K. RIDGWAY, VK3CR.

**Notes Editor:**  
R. W. HIGGINBOTHAM, VK3RN.

**Distribution:**  
H. N. STEVENS, VK3JO.

**Business Manager:**  
J. G. MARSLAND, VK3NY.

**Advertising Representative:**  
W. J. LEWIS,  
20 Queen Street, Melbourne, C.1.  
Telephone: MU 5154.

**Printers:**  
H. HEARNE & CO. PTY. LTD.,  
285 Latrobe Street, Melbourne.

MSS. and Magazine Correspondence should be forwarded to the Editor, "Amateur Radio," Box 2611W, G.P.O., Melbourne, on or before the 15th of each month.

Subscription rate is 6/- per annum, in advance (post. paid).

— IN THIS ISSUE —

Frequency Modulation .....	3
Histogram Recording Behaviour of Sporadic E .....	6
European DX Contest .....	7
List of Call Signs and Countries .....	8
Federal Notes .....	11
QSL Bureau .....	12
Fifty and Up .....	13
Such Nice People .....	14
Divisional Notes .....	16
"Ten" .....	27
Correspondence .....	27
Valves for F.M. Receivers .....	28

## EDITORIAL



For some months work has been proceeding on the production of a new Federal Constitution for the Wireless Institute of Australia.

Whilst the existing Constitution has served us well over the past years, there have been many changes in Amateur Radio during this time, and if the development of the Institute is to be maintained, changes and improvements must be made to the Federal Constitution to provide us with an up-to-date guide for our future planning.

The original draft of this document was circulated to all Divisional Councils for comment and advice. These suggestions have now been incorporated in the final draft, which was approved by the Federal Executive this week.

The new Constitution will now be distributed to all Divisional Executives for their study and guidance. We feel certain that our activities will be further unified and strengthened by its

adoption in all Divisions of the Institute.

Some considerable effort has also been made by the Federal Executive to study each Divisional Constitution, with a view to preparing a single unified Constitution for all Divisions. This work will be related to the new Federal Constitution and will be completed within the next two months.

These and other organisational changes were decided upon at the last Federal Convention. The implementation of the plans then laid down, as a directive for the Federal Executive, will do much to improve and consolidate the work of the Institute as a Federal Organisation.

It is hoped that such organisational improvements will greatly assist us to present our views and requirements in a unified manner, thus enabling us to advance and improve Amateur Radio in accordance with a properly directed and constitutional policy.

W.B.G.

# Homecrafts

**OFFER THESE SPECIAL BARGAINS to AMATEURS**

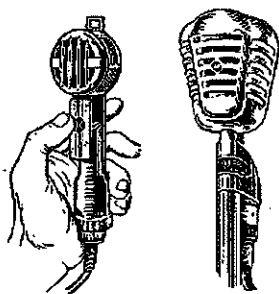

## UNIVERSAL MICROPHONES

Famous American Models in the following types available for immediate delivery:

212A Dynamic . . . . .	£11	0	0
D20C Dynamic . . . . .	£11	12	6
308 Dynamic . . . . .	£9	15	9

All complete with 40,000 Ohm Matching Transformers.

## 3-5 M.C. Transmitting Crystals

3.5 megacycle TRANSMITTING CRYSTALS complete with holder. Reduced from 65/- to . . . . .

**29/6**

## VIBRATOR UNITS

Filtered output of 150 Volts at 15 Milli-amps complete with "Ferrocart" Vibrator. .

**£6 / 8 / 6**

## V.R. 87 CATHODE RAY TUBES

V.R. 87 6" CATHODE RAY TUBES

Normal price £12.

**39 / 6**

Complete with Circuit Blueprint to construct Cathode Ray Oscilloscope

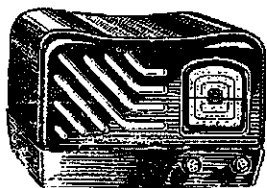

**AN OUTSTANDING BARGAIN!**  
.. BAKELITE CABINET ..  
5-Valve Steel Chassis and Dial Assembly

**45/-** complete.

LARGE FULL-VISION  
DIALS . . . . . **9/11**

4 BANK DUAL WAVE  
SWITCHES . . . . . **4/6**

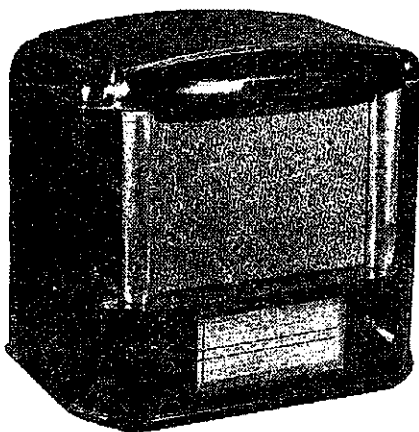

## THE GRAEME A.C. MANTEL MODEL KIT SET

- Reflex Circuit
- 4 New Type Radiotron Valves
- Streamlined Plastic Cabinet
- Full-vision Dial
- 5" Rola Speaker

**13** Guineas

Complete Set ready to assemble.

# HOME CRAFTS PTY. LTD. The Radio & Electrical Specialists

Head Office . . . . . MELBOURNE, 290 Lonsdale Street, and at—

211 Swanston Street, Melbourne. 307 Sturt Street, Ballarat. 139 Moorabool Street, Geelong. 121 Pirie Street, ADELAIDE.

100 Clarence Street, SYDNEY. 26 Hunter Street, Newcastle. Hobart, Launceston and Burnie, TASMANIA.

# FREQUENCY MODULATION— PRINCIPLES AND EQUIPMENT FUNDAMENTALS

By A. H. KAYE\*, B.Sc. (Melb.), A.M.I.E. (Aust.)

The following is taken from a lecture delivered to the Victorian Division of the Wireless Institute of Australia on 1st October, 1947, and discusses in simple non-mathematical terms, the basic principles of radio transmission and reception using frequency modulation. Readers are referred to the very extensive literature on the subject for more detailed information and, in addition, further articles will be published later, on design and construction of items of equipment.

In this paper, I have endeavoured to confine myself to basic principles and fundamentals, and have avoided discussion of technical details of equipment used, and of the relative merits of the various types of equipment which have been developed and discussed in the technical press. I understand that arrangements are being made for members to discuss such matters later.

Mathematical analysis cannot adequately be dealt with in this type of paper and is excluded, but a thorough understanding of frequency modulation, or indeed any system of modulation, involves mathematical investigation.

## FUNDAMENTALS

Any alternating current or electro-magnetic wave has three characteristics with which we are concerned, viz. frequency, amplitude and phase, and any of these three characteristics can be used for the transmission of intelligence. Basically, all that is required is that intelligence shall be able to modulate the electro-magnetic wave at the transmitting end, and that at the receiving end, the equipment shall be able to recognise that the change has been made.

In Figure 1 I have shown a sinusoidal curve representing a modulating signal together with two other curves indicating what happens when a carrier frequency is modulated in amplitude, and in frequency. These curves represent current plotted as a graph against time, and I would draw attention to the following fundamental differences:—

- (a) In respect to carrier frequency:
  - (i) In amplitude modulation the frequency remains constant.
  - (ii) In frequency modulation the frequency changes with the modulation cycle.
- (b) In respect to magnitude:
  - (i) In amplitude modulation, the magnitude of the car-

rier current varies with the modulation cycle and the condition of 100% modulation is defined as one in which the magnitude of the current varies between zero and twice the value of the unmodulated carrier.

- (ii) In frequency modulation, the magnitude of the carrier is constant irrespective of modulation.

Briefly, in amplitude modulation we have a cycle of high amplitude (or current) and low amplitude for each cycle of modulation, i.e. one thousand times per second if the modulating frequency is 1,000 cycles. In frequency modulation we have a cycle of high frequency and low frequency for each cycle of the modulating frequency. It is important to note that the modulating frequency determines the rate at which changes

in amplitude or frequency take place, which would be 1,000 times per second in the case quoted.

A second point to be considered is the amount by which the amplitude or frequency changes. As mentioned above, 100% modulation in the amplitude case means that the magnitude of the carrier changes from zero to twice normal value, and lower depths of modulation than 100% give intermediate values. In frequency modulation the theoretical analogous case would be a change from zero frequency to twice normal frequency, but this is not easily achieved, nor is it desirable, and in practice a maximum frequency deviation, i.e. a maximum allowable change from the normal carrier frequency, is specified, and can in many ways be regarded as similar to 100% modulation.

For lower depths of modulation than 100%, i.e. in the practical case when the audio input is from a low level circuit or voice, amplitude modulation means that the magnitude of the current is confined to limits between zero and twice normal value, while in frequency modulation the change in frequency is less than the maximum allowable deviation.

The third characteristic of the electro-magnetic wave, namely phase, has been excluded from this discussion because of its similarity to frequency modulation. Obviously, a change of phase necessitates a change of frequency and vice versa. Frequency modulation is in fact the same as phase modulation in which the amplitude of the audio modulating signal is inversely proportional to that modulating frequency; this is of great practical importance because by predistorting the modulating fre-

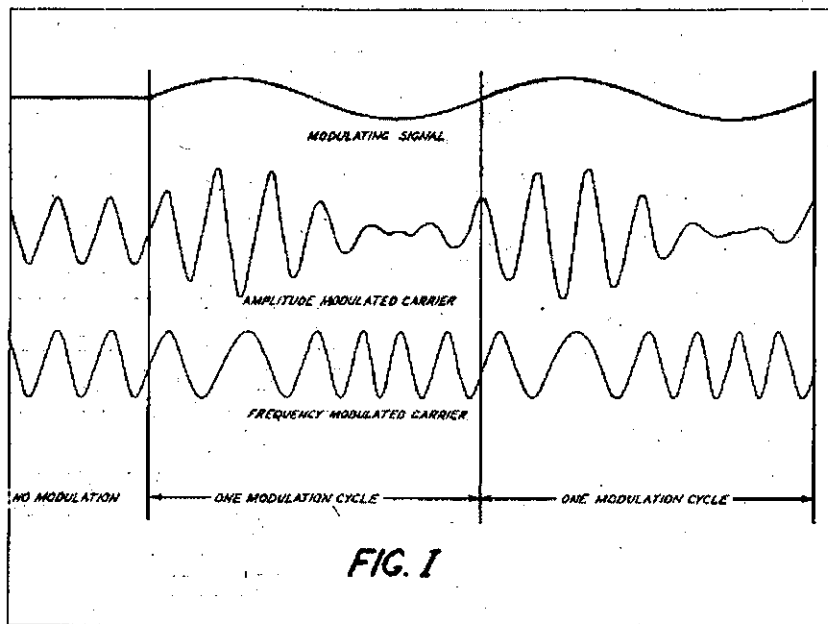

\*Divisional Engineer (Radio Station Construction), P.M.G.'s Department, Central Administration.

quencies according to an inverse law and subsequently phase modulating the carrier, we achieve a frequency modulated carrier.

### ANALYSIS OF MODULATED WAVE AND BAND WIDTH

In amplitude modulation it is well known that a modulated wave can be analysed into three frequencies, viz. the carrier and two side bands, each side band being separated from the carrier frequency by an amount equal to the modulating frequency, one side band being higher in frequency than the carrier and the other lower; this is the case where a single modulating frequency of sinusoidal form is used, but further side bands are generated when the modulating signal is a complex one. The transmission system must be such as to accommodate a band of frequencies wide enough to include the side bands corresponding to the highest modulating frequency which will be used, as for example about 3,400 cycles each side of the carrier for a telephone service, and about 10,000 cycles each side of the carrier for broadcasting. These side bands are indicated by Figure 2.

I will also draw attention to a further feature of amplitude modulation indicated by this figure, i.e. that the amplitude of the carrier is constant and that the side bands represent added power; the total power to be handled by the transmission system is thus higher than the power in the carrier alone when unmodulated, and for 100% modulation this means that the total power handled is 1.5 times the unmodulated carrier power, or 15 kW where the unmodulated carrier power is 10 kW.

In the frequency modulation case, the analysis is not so simple, and with a single modulating frequency an infinite number of side bands is produced, these being separated from the carrier frequency by multiples of the modulating frequency and symmetrically disposed above and below the carrier. This is indicated by Figure 3.

In contrast to the amplitude modulation case where modulation involves the addition of power, in frequency modulation the total power, i.e. power in the carrier plus that in the side bands, is fixed and the carrier power itself is reduced during modulation. This gives an advantage to the frequency modulation system, in that the transmission system is not required to handle, at any time, a greater power than that in the carrier, with an advantage by comparison with amplitude modulation of not less than 3 db, the actual value depending on the system of amplitude modulation considered.

The amplitude of the successive side bands on either side of the carrier follow a Bessel function law, and the amplitude and therefore the im-

portance of the side bands decreases as we proceed to higher order side bands.

It is here necessary to define several terms, which will be used later:—

Deviation is the maximum amount by which the frequency changes above and below the carrier frequency.

Modulation index, which you see in the figure, is the ratio of the amount by which the carrier is changed above and below the carrier, to the modulating frequency causing that change. A special case of modulation index is frequently termed the deviation ratio and is the ratio of the deviation, i.e. maximum change above and below carrier frequency, to the maximum modulating frequency for which the system is designed.

Figure 4 shows how the magnitude of the carrier and of the first pair of side bands varies according to the

modulation index, which as defined above is the ratio between frequency change above and below carrier frequency to the modulating frequency causing that change. It should be noted that under some conditions the carrier magnitude can be zero, and under others negative in sign, which means a phase change of 180°.

From a point of view of satisfactory transmission, it is sufficient only to transmit the significant side bands, and it is generally considered that a band width sufficient to cover side bands on each side of the carrier equal to  $M$  plus 1 times the modulating frequency is satisfactory,  $M$  being the modulation index. As an example, if the modulating frequency is 10,000 cycles per second, the band width required for various modulation indices is given in Figure 5.

I have dealt with only the simple case of frequency modulation where a single modulating frequency is used, and with complex modulating frequencies additional side bands are produced, but the magnitude of the additional side bands is proportional to the product of two Bessel functions and therefore decreases rapidly; also the maximum possible deviation is shared between several modulating frequencies, so that the modulation index for any one frequency is less than it would be if operating by itself.

### NOISE

The subject of noise is introduced at this stage because considerations of signal to noise ratio in the output of a transmission system are fundamental to the problem of providing satisfactory transmission of intelligence; and the band width, deviation ratio and other characteristics of the f.m. system affect this noise output from the equipment.

In the following, it is necessary to keep clearly in mind the difference between carrier-to-noise ratio, which is the ratio between carrier voltage and noise voltage at the receiver input, and signal-to-noise ratio, which is the ratio between audio output voltage, i.e. the required intelligence, and audio output noise, i.e. the resulting interference. Carrier-to-noise ratio and signal-to-noise ratio are not necessarily equal.

The noise voltages encountered in radio frequency circuits may be considered as being modulated both in amplitude and frequency, and when such voltages are superimposed on an amplitude modulated carrier, disturbances appear in the radio receiver output.

In frequency modulation there are two effects, firstly a variation of amplitude as in the case with amplitude modulated carriers, and in the second place the frequency modulated component of the noise phase modulates the carrier, thus causing frequency modulation. In respect to the first effect, the discriminator in

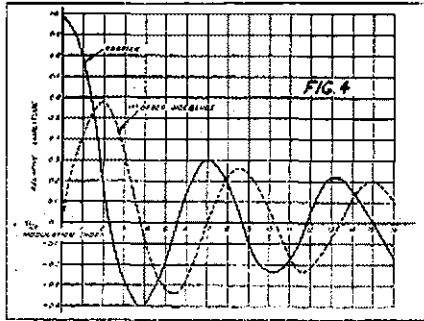
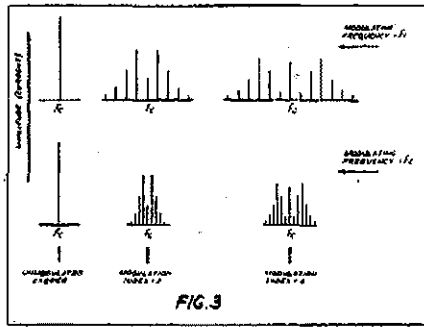
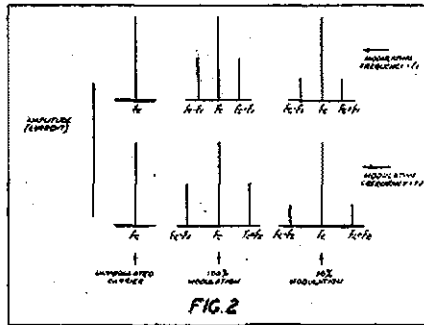

the receiver, i.e. the frequency modulation detector, tends to be unresponsive to amplitude variations, and by use of limiting equipment in the receiver, this effect can be almost completely removed.

As regards the second effect it is a characteristic of phase modulation that the resulting frequency change is proportional to the difference between the carrier frequency and the frequency of the noise or of the interference, and therefore produces at the receiver output an audio voltage proportional to this difference. Thus radio noises of frequencies close to the carrier cause less interference than noises of frequencies further from the carrier. With random noise caused by thermal and shot effects, the noise frequencies are evenly spread over the spectrum and are of almost constant amplitude. Figure 6 indicates the effect such random noise will have in the amplitude modulation and in the frequency modulation cases. This pattern for f.m. is frequently referred to as the "f.m. noise triangle" and the ratio of the interference in the f.m. and a.m. cases equals the ratio of the square roots of the sums of the squares of the ordinates of the triangle and rectangle respectively. The squaring is involved, since noise voltages must be added on an r.m.s. basis and the ratio becomes

$$\frac{1}{\sqrt{3}}$$

or an advantage for f.m. of 4.75 db.

For impulse noise as from ignition systems, the improvement with f.m. is greater and has been shown experimentally to be approximately 6 db.

It is worthy of note that impulse noise has a minimum output when the carrier is unmodulated and the receiver is precisely tuned, thus in silent passages the low noise level from this source is most marked.

It should be particularly noted that in the figure I have used a deviation ratio of unity, i.e. the maximum frequency deviation equals the highest modulating frequency.

This improvement of 4.75 db to 6 db for f.m. over a.m. is only realised if the peak carrier voltage is greater than twice the peak noise voltage, and this requirement is of considerable importance in determining the limit of the service range of an f.m. transmitter.

Where carrier and noise inputs are comparable in magnitude, the phase modulation is not directly proportional to the assumed sinusoidal noise voltage and the audio output from the receiver is not sinusoidal but has a peaked wave shape containing harmonics which greatly increase the interference.

This discussion and the figure deal with the case where the deviation ratio is unity, but it is not necessary or usual to limit the deviations in

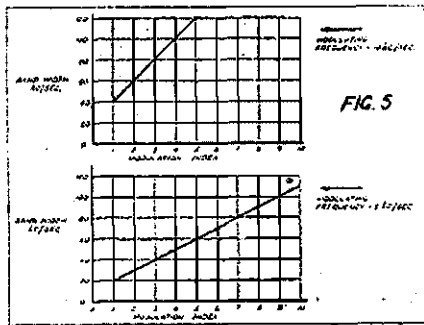

this manner, and by increasing the deviation ratio the audio output in the receiver is similarly increased. As mentioned above, this is somewhat similar to increasing the depth of modulation in the a.m. case. Such increase of deviation will of necessity involve an increase in the band width accepted by the receiver, which introduces further carrier noise frequencies, but provided the peak value of the carrier voltage is greater than twice the peak noise voltage, there is no increase in audio noise in the receiver, because the phase modulation of the carrier by these additional noise frequencies is outside the audible range; increasing the deviation ratio and therefore the receiver band width thus gives a further improvement by comparison with the usual a.m. system as shown in Figure 7.

In connection with the improvement in the signal to noise ratio in the audio output of 4.75 db discussed above in connection with the "f.m. noise triangle" and the additional improvements due to increase in the deviation ratio, it was mentioned that the peak carrier voltage must be more than twice the peak noise voltage. When the carrier signal strength is comparable in value with the noise signal strength, the improvement of f.m. over a.m. due to both these factors disappears, and if the peak carrier to peak noise voltage ratio is less than unity, interaction between the noise frequencies results in the production of noise in the receiver output which is audible.

There is thus threshold carrier signal strength, and a threshold distance from the f.m. transmitter, at which the audio output signal to noise ratio decreases sharply, giving a well defined limit to the service range of the transmitter. Further, the carrier signal strength at which this threshold condition occurs increases with increase of deviation ratio, i.e. other things being equal, the service range is less for high deviation ratio than for low deviation ratio.

Summing up considerations of frequency deviation, signal to noise ratio in audio output, and threshold distance, we have:—

- (a) Increase of deviation ratio means improved signal to noise ratio in the audio output of the receiver; and

- (b) Increase of deviation ratio means a decrease of threshold distance.

Thus the choice of deviation ratio in this connection is a matter of compromise and the best solution depends on the nature of the service to be given, e.g. broadcasting service requires a good signal-to-noise ratio in the receiver output throughout the service area of the transmitting station, whereas a communication service as required by the Police Department demands maximum threshold distance and provided the signal to noise ratio does not fall to too low a value this is a secondary consideration.

Figure 8 indicates how signal-to-noise ratio and threshold distance depend on the deviation ratio; for comparison an amplitude modulated case is also given in the figure.

It should be particularly noted that these characteristics of signal to noise ratio and threshold distance depend on the deviation ratio or

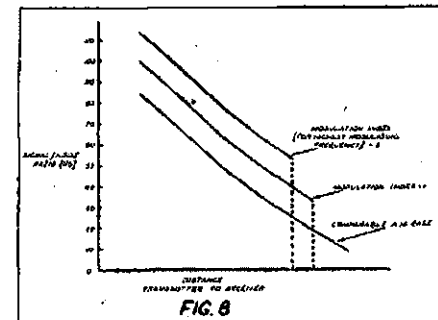
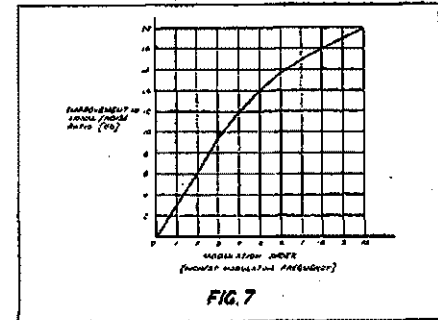
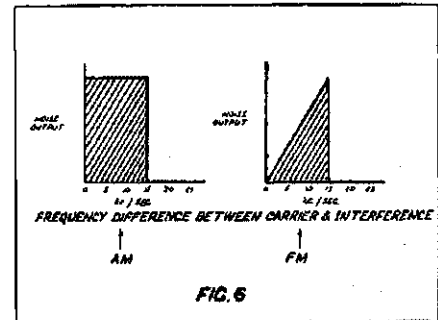



modulation index, not on the deviation itself, i.e. conditions are similar with a deviation of 15 Kc. and a maximum modulating frequency of 3 Kc. or with a deviation of 75 Kc. and a maximum modulating frequency of 15 Kc., since both these arrangements give a modulation index of 5.

### INTERFERENCE FROM OTHER STATIONS

Interference from other stations, whether they be amplitude or frequency modulated, behaves in a manner similar to noise and provided the desired station signal strength is approximately twice that of the unwanted station, interference is much less in the case of frequency modulation than it is with amplitude modulation. When the desired signal is demodulated the weaker interfering signal appears as a super-imposed heterodyne of frequency equal to the instantaneous frequency difference between the two stations, and when the interfering station also is frequency modulated this heterodyne takes a varying and complex form.

When both stations are of the high deviation ratio type, as for

instance in broadcasting, instantaneous frequency difference will, on the law of averages, be almost entirely supersonic and therefore inaudible; even when both stations are on the same carrier frequency the heterodyne will, for some 40-60% of the time, be inaudible.

This suppression of a weaker station by a stronger one is an important characteristic of f.m. transmission and is sometimes referred to as the "capture effect." Thus, when the service areas of two stations overlap there will be little interference one with the other except in a relatively limited zone where the signal strengths are sensibly equal.

### RADIO FREQUENCIES

It has been seen above that improvement by comparison with amplitude modulation is most marked when high deviation ratios are used involving wide band transmission. Spectrum space for wide bands cannot be spared in the frequency ranges that have been extensively used for other purposes up to the present, and in fact some frequency ranges are already grossly overcrowded. For instance, in the present medium frequency broadcast band from 550-1500 Kc., there are 96 channels suit-

able for amplitude modulation, using a channel spacing of 10 Kc., but if the same range of frequencies were used for frequency modulation with a channel spacing of about 200 Kc., there would only be 4 or 5 channels.

There is no inherent reason why frequency modulation should not be used at the low or medium radio frequencies, except because of the force of circumstances that there is insufficient spectrum space left and as a result frequency modulation is used at higher frequencies, in practice the lowest working channel being about 40 Mc.

There is, however, one factor which reduces somewhat the application of frequency modulation using wide bands and high modulation indices to lower frequencies in that multipath transmissions as could be encountered in long distance ionospheric propagation cause selective fading because of the large number of side bands involved.

Three important misconceptions regarding frequency modulation have arisen by reason of this operation at very high frequencies. These are:—

(i) **Range.**—It has been mentioned as a disadvantage of frequency modulation that the service range is limited to optical or near optical distances, but this is a function of frequency, and the same objection would apply to amplitude modulation if used at such frequencies. Also because of this limited range, it is possible to share channels extensively by separating the stations geographically; apart from the benefit derived from the "capture effect," this state of affairs would be similar for amplitude modulation.

(ii) **Noise.**—It has been seen above that frequency modulation has great advantages over amplitude modulation in respect to signal-to-noise ratio in the output of the receiver, but in addition interference due to static is lower at the higher frequencies, and this has been credited to frequency modulation, whereas similar benefits are obtained with amplitude modulation at such frequencies. It is of interest to note that one of the reasons for this lower noise level is that noises generated at distant points are not received because of the optical or near optical propagation properties at very high frequencies.

(iii) **Fidelity.**—This comment applies particularly to broadcasting, and it has been claimed that frequency modulation gives us the possibility of transmitting an audio frequency range extending to 15 Kc. It might be debatable whether or not this extension of the audio frequency range is truly an advantage, but in any case 15 Kc. audio frequency range could be transmitted quite well with amplitude modulation provided adequate spacing between channels is arranged.

(To be concluded.)

## HISTOGRAM RECORDING BEHAVIOUR OF SPORADIC E

Of interest to V.H.F. enthusiasts generally is the Histogram shown below depicting the behaviour of the E layer (or Sporadic E) during the period July, 1943, to June, 1947, as recorded by the Radio Research Board at their Brisbane Recording Station and through the courtesy of whom the data has been made available.

As will be seen the maxima during December and January is most marked as is the mid-winter peak, while the readings for September show clearly the reason for the lack of any spectacular achievements on the Field Day held in September last.

The method of plotting the graph is of interest. When Frequencies in excess of 2, 3, 5, and 7 Megacycles are reflected, each is multiplied by a factor of 1, 2, 3, and 4 respectively, and it will be obvious that a predominance of high frequency reflections on any given day will result in a high reading for that particular day. The loading of the lower frequencies is taken into account to, in effect, broaden the canvas on which the picture is painted, and to obviate what otherwise might be a purely local condition.

We are indebted to VK4ZU for the above.

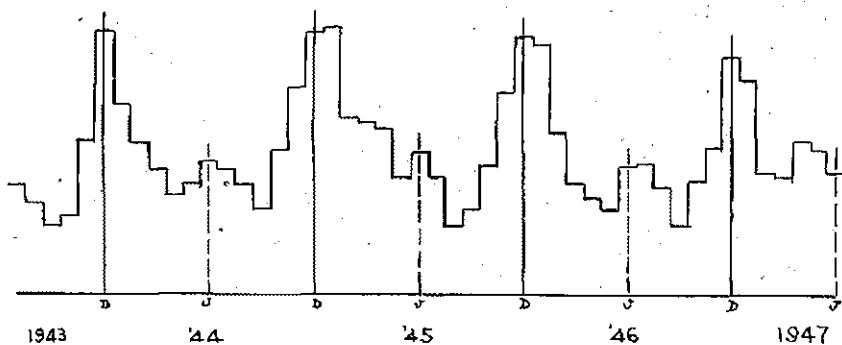

LOADING ES HISTOGRAM - 1943-47.

# ALL EUROPEAN DX CONTEST

The Netherland Radio Society, V.E.R.O.N., is sponsoring the first post-war European Contest, and the rules of the Contest, which will be conducted in November and December, are as follows:—

## GENERAL PLAN OF CONTEST

Amateurs with European prefixes will be taking part in a QSO Party with stations in all parts of the world. When they effect DX QSOs, self-assigned serial numbers (three-figure report plus three self-assigned numbers that will be sent all stations) will be exchanged and noted in the contest report. From this record each station will submit its score. From the scores (which the Contest Committee will verify by cross-examination of logs) the winners will be determined for each locality, and will be awarded certificates. Three points will result from a full exchange in any band, but no more can be counted for the same station unless both stations connect in another band for additional exchanges.

Stations outside Europe will try to work as many European stations as possible to exchange serial numbers. Stations in all localities need only take part on the contest dates and report results at the end of the tests to be eligible for awards. The main

competition, each operator must consider, comes from the individual operators in his country using the same prefix. Consult the list of call prefixes for the different countries of the world as given in the February 1947 issue of QST. Separate certificates will be awarded the c.w. and the phone winner for each country and likewise for each district in the U.S.A. and Canada. The first week-end is a contest for c.w. Hams and the second week-end a separate contest for phone Hams. In no sense will it be a competition between c.w. and phone operators.

The contest times are based on Greenwich time and should be computed for any part of the world from "Greenwich."

## CONTEST RULES—C.W.

1. The contest runs from Friday, 28th November, 1801 G.C.T., until Sunday, 30th November, 2359 G.C.T., 1947.
2. Only c.w.-c.w. QSOs will count.
3. A six-figure group is exchanged. The first three digits of the serial

number sent shall constitute the RST reports of the station to which the number is sent. As the last part, a self-assigned three-numeral group is used that stays the same throughout the contest.

4. All contest work must take place within the contest period.

5. Logs must include: call, date, time, serial numbers exchanged, band used and points claimed.

6. All bands may be used.

7. Off-frequency operation will result in disqualification.

8. Scoring: Both European station and the station outside Europe receive one point when the European serial number is acknowledged by the station outside Europe. Each station, similarly, may add two additional points when a six-figure number has been acknowledged by an European station. Every good QSO counts a maximum of 3 points. Scoring points shall be multiplied by the number of worked countries. The multiplier is increased by working the same countries on additional bands.

9. For European stations there is a quota of three stations per country that may be worked, except that if one-way exchanges with some of these three have been made, more stations can be worked. European stations cannot get more than 9 points (basic) per country. This quota shall be permitted in each different band. For stations outside Europe there is no quota limit.



## MORE AND MORE AMATEURS

Are choosing their component parts from VEALLS. Join this progressive group and avail yourself of the excellent service and free technical advice.

SOUTH OF THE YARRA HAMS.  
Keep on the beam by making our Prahran Store your Headquarters.  
Contact VK3FR (Fred Smith)

# VEALLS

243 Swanston St., Melbourne. FJ 3145.  
299 Chapel Street, Prahran. LA 1605  
Mail Orders: Box 2141T, G.P.O., Melb.

## This month's items of interest

### available at VEALLS

- ★ TAYLOR TUBES  
Nos. 866 J, TZ 40, T 21, T 55,  
TZ 20, T 125.
- ★ PHILIPS LOG DIALS,  
25/- each.
- ★ ADJUSTABLE HOLE CUTTERS  
Cut aluminium and steel with  
ease. 16/10 each.
- ★ REVOLUTIONARY KINGSLEY  
K/S 9'ER.  
£5/5/- (plus valves).

Ham Discount Where Applicable.



ON	Belgium	UM8	Kirghiz	VS4	Borneo, British North
OQ	Belgian Congo	UN1	Karelo, Finnish Rep., Soviet Union	VS5	Brunei (Sarawak)
OX	Greenland			VS6	Hong Kong
OY	The Faeroes	UO5	Moldavia Soviet Union	VS7	Ceylon
OZ	Denmark	UP	Lithuania	VS9	Aden and Socotra Islands
PA	Netherlands	UQ	Latvia	VU	India
PJ	Neth. West Indies	UR	Estonia	VU4	Laccadive Islands
PK	Java	VE	Canada	VU7	Bahrein Islands
PK4	Sumatras	VK	Australia	W	U.S.A.
PK5	Borneo, Neth.	VK4	Papua	XE	Mexico
PK6	Celebes and Molucca Islands	VK9	New Guinea Territory	XU	China
	New Guinea Neth.	VO	New Foundland and Labrador	XZ	Burma
PX	Andorra	VP1	British Honduras	YA	Afghanistan
PY	Brazil	VP2	Leeward and Windward Is.	YI	Irak
PZ	Guiana (Neth. Surinam)	VP3	Guiana, British	YJ	New Hebrides
SM	Sweden	VP4	Trinidad and Tobago	YN	Nicaragua
SP	Poland	VP5	Caymen Is., Jamaica, Turks and Caicos Islands	YR	Romania
ST	Anglo Egyptian Sudan	VP6	Barbadoes	YS	Salvador
SU	Egypt	VP7	Bahama Islands	YT	Yugoslavia
SV	Crete and Greece	VP8	Falkland Is., South Georgia, Sandwich Is., Orkney Is., and Shetland Is.	YU	Yugoslavia
SV5	Dodecanese Islands (Rhodes)	VP9	Bermuda Islands	YV	Venezuela
TA	Turkey	VQ1	Zanzibar	ZA	Albania
TF	Iceland	VQ2	Rhodesia, Northern	ZB1	Malta
TG	Guatemala	VQ3	Tanganyika Territory	ZB2	Gibraltar
TI	Cocos Island and Costa Rica	VQ4	Kenya	ZC1	Trans Jordan
UA1-3-4-6	European Russian Soc. Fed. Sov. Rep. Soviet Union	VQ5	Uganda	ZC2	Cocos Island
UA9-0	Asiatic Russian S.F.S.R. Soviet Union	VQ6	Somaliland, British	ZC3	Christmas Island
UB5	Ukraine, Soviet Union	VQ8	Chagos Is., Mauritius	ZC4	Cyprus
UC5	White Russian S.S.R., Soviet Union	VQ9	Seychelles	ZC6	Palestine
UD6	Azerbarjan Soviet Union	VR1	Gilbert and Ellice Is., and Ocean Island	ZD1	Sierra Leone
UF6	Georgia	VR2	Fiji Islands	ZD2	Nigeria
UG6	Armenia	VR3	Fanning Is., Christmas Is.	ZD3	Gambia
UH8	Turkoman	VR4	Solomon Islands	ZD4	Gold Coast and Brit. Togoland
UI8	Uzbek	VR5	Tonga (Friendly) Islands	ZD6	Nyasaland
UJ8	Tadzhik	VR6	Pitcairn Island	ZD7	St. Helena
UL7	Kazakh	VS1-2	Malaya	ZD8	Ascension Island
				ZD9	Tristan da Cunha and Gough Islands

(Continued on page 12)

**"ALL-ROUND" EFFICIENCY**

**TRIMAX TRANSFORMERS**

Available in Line to Line, Line to Grid, Plate to Line, Interstage—Single and Push-Pull Types—Trimax Transformers are constructed of the finest materials and feature high Permeability, Nickel Iron Alloy core—heat treated in our own factory for Optimum results.

Also for Amplifier enthusiasts . . . Standard or Custom built Chassis, Speaker Flares, Microphone Stands, Power Transformers, Filter Chokes, etc.

**TRIMAX TRANSFORMERS**  
(Division of Cliff & Bunting Pty. Ltd.)  
29-35 FLEMINGTON RD., NORTH MELBOURNE

Interstate  
Representatives:

**N.S.W. :**  
L. B. Graham,  
5 North York St.,  
SYDNEY

**QUEENSLAND :**  
Chandlers Pty. Ltd.  
Chr. Albert and  
Charlotte Sts.,  
BRISBANE

**S.A. :**  
C. N. Muller  
Warando Buildings,  
Grenfell Street,  
ADELAIDE

**W.A. :**  
R. D. Benjamin,  
197 Murray Street,  
PERTH

**TASMANIA :**  
W. & G. Genders  
Pty. Ltd.,  
53 Cameron Street,  
LAUNCESTON

ENQUIRE FROM YOUR NEAREST SUPPLIER

# 16 SWAN STREET, RICHMOND

AMATEURS AND RADIO EXPERIMENTERS, SEE US FOR ALL YOUR RADIO REQUIREMENTS.

WE HAVE A VERY LARGE AND EXTENSIVE RANGE OF SHORT WAVE EQUIPMENT. A NEW SHIPMENT JUST ARRIVED. ALSO LARGE CONSIGNMENT OF VALVES OF ALL TYPES, including:—807, 6J7, 6V6, 6B8, 6U7, 6K8, 6J8, 6SH7, 6AC7, 9002, 9003, 954, 955, 956, 5V4, 5YB, 6X5, VR105, VR150, 9072, 1603, 879. ALL TYPES OF 2-VOLTS AND 1.4 SERIES.

SPECIAL DISCOUNT GIVEN TO HAMS.

## COMPARE OUR PRICES

**COMMUNICATIONS RECEIVERS** include:—The A.W.A. Type, AR8 Receivers, All Wave, 6 Band, B.F.O., works off A.C. or D.C. 12 Valve, 6.5 Volt series. Band coverage, 20 Meg. to 140 K.C. Excellent set for all purposes. With Power Supply, £25; less Power Supply, £15.

**AMERICAN R.C.A.** 8-valve Receiver, model DZ2. Covers broadcast and long-wave frequency. 750 K.C. to 32.5 K.C. Less Power Supply. Sacrifice at £25.

**HIGH FREQUENCY RECEIVERS.** Types AR301 and 46AAT. Covering 2½-6 metres. Valve line-up, 5 tubes, 955-956. Mixer stage—4-6 A.C., 7's, I.F. Stage, 2 Meg., 5V4. Rectifier. Power Supply, &c. A gift at each £15

**MARCONI TRANSMITTER.** Type T1154. Phone or C.W. Preselector Band Switching. As new. Less Power Supply £17/10/0

**RAC AR 12-7-valve Communication.** 4 Band. RF gain control. Xtal gate, BFO, &c. Battery operated. Sacrifice £25

**COILS,** plug-in type, for Australia and English AR14 Receivers, 25/- box or 1/6 each. Order now while supplies available.

**VALVES.**—We have large quantity of all types of Valves. Transmitting and Receiving.

**TELEPHONE SWITCHBOARDS.** 10 line. Good order, from £3 to £12 each. The Units have many uses on farms, &c.

**WAVE METERS, CLASS C, AUSTRALIAN A.W.A.,** vibrator operated. Complete with Spare Vibrator. To clear £5 each

**CRYSTAL CALIBRATORS.**—We have in stock limited number of Crystal Calibrators, harmonic freq. range 1000, 100, 50 K.C. Vibrator operated, 6-volt. To clear £15

**OSCILLATOR.** 75 meg., complete with output meter, very elaborate, 230 A.C. operated £25

**HIGH-FREQ. TRANSMITTERS and OSCILLATORS.** We have in stock several of these units, which may be useful to high-freq. experiments. Also have a quantity of incomplete units for wrecking purposes.

**AMERICAN TRANSMITTERS.**—20-watt Plug-in band type, CBY 52063A. Phone or C.W. valve line-up, 2 89's into 2 837's. RF meter, &c. Limited quantity only £20

**REMOTE CONTROL UNITS,** complete with mic. and phones. Morse key. Can be used for house phones, &c. Condition as new. To clear £1 each Order now.

**EARPHONES.**—Several types, including crystal, moving coil, magnetic. U.S.A. Navy types, with large ear pads. 35/- to £3 per pair Limited quantity only.

**TRANSCIEVERS, 109's, S.T.C.,** 9 Valves, covers 80-metre band. Tube line of Receiver, 6U7's, 6K8's, 6B6's. Transmitter, 3-807's. Receivers easily convertible for local reception, 6-volt Vibrator operated. Price £12/10/0

**TRANSMITTERS.**—Famous A.T.5 50-watt, phone or C.W. Xtal or V.M.O. Tube line-up Occ. 6V6, Doubler 807, 2-807 in parallel in final. Band coverage 500 K.C.-15 Mc. Meter covers all stages. Input 12-volt A.C. or D.C. H.T.500-V-300. Generator supplied with unit, or A.C. Transformers and chassis supplied. Also Aerial Coupling Unit Price £25

**TRANSMITTERS.** 3B.Z. A.W.A. Xtal controlled, 6 holders, band coverage 3.5 Mc. and 7 Mc. Tubes used, 4.6V6's-1-807, Vibrator operated off 12-volt battery. Meter for all stages. This set operates on phone of C.W. Price £17/10/0

**TRANSMITTER.** American type, BC-191-E, 100-watt, phone or C.W. Precision built. Plug-in band change coils. Very elaborate power supply, adjustable filament and H. tension voltages, circuit breakers, relays, &c. A beautiful job: a welcome addition to any ham shack. Price £75

**METERS.**—All types. R.F. Thermo Couple, 0 to 1 A.M.P., 15/- D.C. Milliampere 0 to 300 Mill., 15/-

**FILTER CHOKES AND CONDENSERS, RESISTORS, VARIABLE AND FIXED.**

Inspect all those items at

## SPARE PARTS

16 Swan Street . . . Richmond

Phone: JA 3327.

After Hours: Haw. 4465

SPECIAL ATTENTION GIVEN TO COUNTRY MAIL ORDERS.

# FEDERAL NOTES

## NEW FEDERAL SECRETARY

In these notes last month the resignation of Alec Clyne, as Federal Secretary, was announced with regret. The Headquarters Division (Victoria) has approved of the nomination of Bill Mitchell (VK3UM) as Alec's successor and we take this opportunity of greeting Bill to his new post in which we wish him every success.

## FREQUENCY DATA FROM R.S.G.B.

One of the main thoughts which has been in the minds of most Amateurs is the outcome of the Atlantic City Conference on Telecommunications and in this regard the Federal Executive have not, as yet, received any official advice from our representatives, I.A.R.U., as to the results achieved. The following is taken from a special communication issued by the Radio Society of Great Britain to all their members and in no way is to be interpreted as the final allocations for either United Kingdom or Australian Amateurs.

Band	Width	Remarks
*1715- 2000 Kc.	200' Kc.	200 Kc. shared (max. power 10 watts)
3500- 3800 "	300 "	Shared.
7000- 7100 "	100 "	Exclusive.
7100- 7150 "	50 "	Shared.
14000-14350 "	350 "	Exclusive except that U.S.S.R. proposes to operate internal Fixed Services between 14250-14350 Kc.
21000-21450 "	450 "	Exclusive.
28000-29700 "	1700 "	Exclusive.
144- 146 Mc.	2 Mc.	Exclusive.
420- 460 "	40 "	Shared (harmful interference clause inserted concerning interference with Air Navigation Aids).
1215- 1300 "	85 "	Exclusive.
2300- 2450 "	150 "	Exclusive.
5650- 5850 "	200 "	Exclusive (I.S.M. equipment will operate at 5850 Mc.—tolerance $\pm$ 0.6%).
10000-10500 "	500 "	Exclusive.

\*These figures are as supplied by R.S.G.B.

Whilst on paper the United Kingdom has lost the 56 Mc. band, they have every reason to believe that frequencies around 60 Mc. will be allotted later, on a national basis.

Note.—There is a strong possibility that they shall be given permission to use the I.S.M. (Industrial Scientific and Medical) Band around 11 Metres.

## NARROW-BAND F.M.

Following on the recent release of frequency modulation and pulse transmissions by the Postmaster General's Department, the Federal Executive sought information on the standards that had been decided upon in both the United States of America and the United Kingdom. R.S.G.B. have advised that neither types of transmission have been granted them as yet, but A.R.R.L. state—

"Here we have two sets of standards with respect to the use of frequency modulation in the Amateur

Bands. On 29-29.7, 52.5-54, and all bands above 144 Mc., frequency modulation techniques may be used, including the so-called wide-band system.

"For a one-year test, which began on 1st August, 1947, the frequencies 3850-3900, 14200-14250 and 28500-29000 Kc. have been opened to 'narrow-band frequency modulation' techniques. The Federal Communications Commission defines this as a 'system of frequency modulation where the peak deviation is limited to a value equal to or less than the maximum modulation frequency.' In other words, the band width must not exceed that occupied by an amplitude modulated signal of the same audio characteristics.

"Since 'practically anything' is permitted on the 11 Metre band, I should have included it in the above frequencies available for frequency modulation techniques. Incidentally, the Atlantic City Conference has decided on a new industrial heating

frequency of 27120 Kc., which we mean our 11 Metre band will some day be 26960-27230 Kc. I am glad to say Australia and New Zealand gave notice of its intentions to permit Amateur sharing of this band, as in the American Region."

## YOUR ASSISTANCE PLEASE!

In order to give full effect to Motion 41 of the last Federal Convention, the Federal Secretary is still awaiting further information regarding the names of those Amateurs who paid the supreme sacrifice in the 1939-45 war.

Furthermore, your comments and suggestions are awaited regarding the companion handbook to the P.M.G. Handbook for the operation of Amateur Stations. This publication will contain—

(a) Guiding principles for the efficient operation of Amateur Stations.

- (b) Standards of station design and installation covering basic principles, fire insurance requirements, safety standards, etc.
- (c) Reasons why all Amateurs should be members of the Wireless Institute of Australia.

## NEW APPOINTMENTS

Sub-Editor of "Amateur Radio": VK4ZU, Mr. H. T. MacGregor.  
Asst. Sub-Editor "A.R.": VK4FN, Mr. Frank M. Nolan.

## YOUR ATTENTION PLEASE!

In order to save confusion and delay in routing of correspondence received in Box 2611W, G.P.O., Melbourne, your co-operation in correctly addressing all letters would be appreciated.

Federal Secretary:—

All correspondence dealing with purely Federal matters such as Editorials, Federal Notes, Policy of the Magazine and Regulations, should be addressed to the Federal Secretary.

Secretary, Victorian Division:—

All correspondence concerning VK3 matters only, should be addressed to the Secretary, Victorian Division.

Magazine Manager:—

All correspondence relating to the financial and distribution aspects of the Magazine.

Editor, "Amateur Radio":—

All correspondence concerning Notes and other contributions to the Magazine.

Federal QSL Manager:—

All correspondence dealing with QSL matters, applications for W.A.C. Certificates or Awards (or the VK3 Manager, if applicable).

Patriotic Fund:—

All matters dealing with Food for Britain food parcels, raffles, etc. to be endorsed as above.

## CALL SIGNS

### Alterations:—

- VK2AKD—E. J. Paxton, 22 Powell St., Killara, N.S.W.  
VK2AKU—J. Georgeson, 6 Carlos Rd., Artamon, N.S.W.  
VK2ANT—F. R. Deppeler, 80 Kincaid St., Wagga Wagga, N.S.W.  
VK2ASD—S. T. Clark, Imperial Hotel, Manila St., Manila, N.S.W.  
VK2FG—E. C. Medhurst, 46 Ultima St., Caringbah, N.S.W.  
VK2VI—V. J. Gay, 23 Centennial Ave., Lane Cove, N.S.W.  
VK3AT—Dr. A. F. Taylor, 108 Mandel St., Shepparton, Vic.  
VK3SF—N. C. Hannaford, No. 1 Aus. Tels. Course, Army School of Signals, Balcombe, Vic.  
VK3SO—B. L. McCubbin, 3 Kildare St., Burwood, Vic.  
VK5LR—J. Lester, 333 Brighton Rd., Brighton, S.A.  
VK5RC—R. Bennett, 65 Federation Rd., Port Pirie, S.A.

**New Issues:—**

- VK2ADP—A. D. Potter, 315 Piper St., Broken Hill South, N.S.W.
- VK2MC—W. R. Attwood, 34 Cram St., Merewether, N.S.W.
- VK2MD—R. M. Cumming, Jnr., "Kinross," 5 Gower Cres., Summer Hill, N.S.W.
- VK3NV—M. J. Ryan, 8 Bain Ave., Merlynston, Vic.
- VK3PL—J. F. Isaac, 72 Young St., Frankston, Vic.
- VK3PS—E. Salamy, 23 Henna St., Warrnambool, Vic.
- VK3SP—R. H. Sears, 32 Manifold St., Colac, Vic.
- VK3XH—C. H. Hyatt, 56 Darebin Rd., Heidelberg, Vic.
- VK3XO—L. A. Paul, 160 Separation St., Northcote, Vic.
- VK4DB—D. S. Brown, 72 Watson St., South Bundaberg, Qld.
- VK4LM—L. E. H. Mallinson, 62 Prince St., Annerley, Qld.
- VK5WA—R. A. Warner, 60 Charles St., Forestville, S.A.
- VK6AI—W. J. Middleton, Esplanade, Port Hedland, W.A.
- VK6BH—B. G. Hudson, 268 Newcastle St., Perth, W.A.
- VK6CF—C. L. Farkas, 165 Railway Rd., Gooseberry Hill, W.A.
- VK7RY—F. E. Nicholls, 21 Haig St., Newtown, Tas.

**Call Signs and Countries**

(Continued from page 9)

- ZE ..... Rhodesia, Southern
- ZK1 ..... Cook Island
- ZK2 ..... Niue
- ZL ..... New Zealand
- ZM ..... Samoa, Western
- ZP ..... Paraguay
- ZS ..... Union of South Africa
- ZS3 ..... South West Africa
- ZS4 ..... Basutoland

**NO CALL LETTERS ALLOTTED**

- The following have no call letters allotted as yet:—
- Aldabra and Andaman Islands.
  - Bechuanaland, Bhutan, Bonin Is.
  - Caroline Is., Clipperton Is. and Comoro Is., Corsica.
  - Easter Is.
  - Formosa, Franz Joseph Land.
  - Galapagos Is., Guinea (Spanish).
  - Ifni, Imo Jima.
  - Jan Mayen Is.
  - Kerguelen Is., Korea, Kuwait.
  - Maldiva Is., Manchuria, Marshall Is., Monaco, Mongolia.
  - Nepal, Nicobar Is.
  - Okinawa, Oman.
  - Palau Is., Phoenix Is. (British), Principe Is.
  - Rio de Oro, Ryu Kyu Is.
  - Sao Thome Is., Cardinia, Somaliland (Italian), Spitzbergen, Svalbard, Swaziland.
  - Tannu Tuva, Tokelan Is., Trieste.
  - Union Is.
  - Volcano Is.
  - Wrangel Is.
  - Yemen.

**FEDERAL QSL BUREAU**

**RAY JONES, VK3RJ, MANAGER**

Several cards are to hand for VK1 stations. Some are addressed to Norfolk Island. Many relate to QSOs during the first half of 1947. Has anyone any ideas where the owners may be found?

An attractive card notifies the holding of a hamfest in Stuttgart by the German listening fraternity. A superscription on the cards reads: "OMs pse don't forget the German Hams, Greetings from the German post-war hampest." Of course it is a typographical error but it is peculiarly apt.

Another one for the philatelist.—Helene Kehler, ex-D3FBA (24b) Husum-Nordsee, Kampsiedlung-Lund 17, Schleswig-Holstein, Brit-Zone, Germany.

The QSL address for the N.E.I. is: N.I.V.I.R.A., Postbox 190, Batavia.

The Radio Club Argentino asks for reports on the signals of their station "LRAI, Radio del Estado," broadcasting on 9690 Kc. All reports will be acknowledged. The address of the R.C.A. is A. V. Alvear, 2750, Beunos Aires.

A groan from James H. Dooley (W2JCT) who operated XU1YR, at Chin Wang Tao, Hopeh Province, China, from approximately October, 1946, to June, 1947. Jimmy Dooley says that out of 60 VKs contacted and QSLed, so far only 4 have sent him cards. Seems poor recompense. Dooley is now back at his home address, 405 Berkeley Ave., Bloomfield, N.J., U.S.A.

Dave Medley, VK5AE, ex-VK3MJ, advises that Box 234, P.O., Darwin,

N.T., will be sufficient address for any cards for stations in that area.

Leo Maguire, long time pre-war VK3KM, of Wodonga, has turned up again as VK6MG, at Manjimup, W.A. Hope contact you one day when 7 Mc. is clear Leo.

The new QSL Manager for the British Zone of Occupation in Germany, is D2DS, Capt. J. Howe, R. Signals, Exits and Entries Branch, Zonal Executive Offices, Control Commission for Germany, Bad Salzufen, 100 HQ, C.C.G., British Army of the Rhine. That's the full address and Capt. Howe requests that cards for D2 calls should not be sent to any of the German Bureaux operated by the Radio Clubs.

News from Denmark states that to August 20, the record for 56 Mc. work in OZ belongs to OZ7G who worked F9BG, at Toulon, France, a distance of 850 miles. Other contacts were with GM8MJ, GM6KH, I1DA, F8QL, HB9CD, F8OL, G2VH, G5BY, G3YH all over the 500 mile distance. They state that the stations doing the best work are using 50 watts to beam antennae and excellent German V.H.F. superhet receivers. Their summer camp at Fuen was a great success this year and included visitors from England, Norway, Sweden. Currency restrictions prevented many other foreign amateurs from joining the Danes in the celebrations attending the 20th anniversary of the foundation of the E.D.R.

Victorian stations please do not forget to drop that envelope to Graham Roper, VK3ZB, 26 Lucas St., Caulfield, S.E.8, for your cards.

**GLO-RAD**

**CUSTOM BUILT EQUIPMENT**

**CAREFULLY ENGINEERED TO MEET**

**YOUR INDIVIDUAL REQUIREMENTS**

"GLORAD" is now in a position to cater for  
**YOUR requirements, large or small.**

Send sketches and full details to:—

**GLORAD ENGINEERING SERVICES**

**186A Riversdale Rd., (Cr. Robinson Rd.)**

**HAWTHORN ————— VICTORIA**

**Phones: Day—WA 3819. Night—WX 3440**

**SUBSCRIPTIONS arranged to any magazine or paper throughout the world.**

**AMERICAN**

<b>RADIO—</b>			<b>SCIENTIFIC AND PHOTOGRAPHY—</b>		
Audio Engineering	£1	6	Popular Science	£1	3
Communications	£1	2	Popular Mechanics	£1	3
C.Q.	£1	5	Mechanix Illustrated	£1	2
Electronics	£4	17	Scientific American	£2	0
F.M. and Television	£2	0	Science and Mechanics	£2	15
Proceedings of the Institute of Radio Engineers	£3	19	Science Digest	£1	3
Q.S.T.	£1	7	American Photography	£1	6
Radio Craft	£1	2	Camera	£1	13
Radio News	£1	12	Popular Photography	£1	6
Service	£1	2	U.S. Camera and Travel	£1	0

**ENGLISH**

Electronic Engineering	£1	12	Wireless World	£1	5
Practical Wireless	£0	9	Wireless Engineer	£2	0
Short Wave Magazine	£1	5			

**AUSTRALIAN**

Amateur Radio	£0	6	Radio and Hobbies	£0	6
Australian Radio World	£0	10			

**JUST PUBLISHED:—The Australian Short Wave Handbook — a handbook of Call Signs and Short Wave technique, specially compiled for Australian conditions. Published by Radio and Hobbies. PRICE: 2/- Postage 2d.**

**VERY LARGE RANGE OF TECHNICAL BOOKS ON ALL SUBJECTS.  
WRITE FOR LIST ON THE SUBJECTS YOU ARE INTERESTED IN.**

# McGILL'S AUTH-NEWS AGENCY

Established 1860.

183-85 ELIZABETH STREET, MELBOURNE, C.I., VICTORIA.

(The G.P.O. is opposite).

TELEPHONE: C. 8113-4.

## FIFTY AND UP

COMPILED BY VK3QO

### VK5 AND VK2 CONTACT

The following details from VK5 are a bit late, but better late than never! On the night of Tuesday, 23rd September, VK5 50 Mc. enthusiasts received another visit from three of the VK2 gang, all from well north of Sydney; Newcastle, Cessnock and Wyong being represented.

Towards evening VK5RV and VK5GF, listening on 28 Mc., noticed the skip shortening; DX dropped out and VK2s started to come in. As the skip shortened and the VK2s dropped out, Jock and Max took a dive down to 50 Mc. and started calling CQ DX. At 1825 hours VK5GF was rewarded with a call from VK2ADT (R5 S9) who reported Max at R5 S8. Experiments were carried out with both vertical and horizontal polarisation and with beams against half-wave antennae "straight." Results were much in favor of the beam, but polarisation made no difference.

At 1835 hours VK5RT switched on and heard VK2BZ calling CQ "Six." Resultant QSO was at R5 S9 both ways. At 1840 hours VK5RT and VK2ADT contacted at R5 S9 both ways and five minutes later VK2BZ, at R5 S9, was QSOing VK5GF at R5 S8. Later again VK5RV contacted

VK2BZ R5 S9. Jock's signal was down at Newcastle however, VK2BZ having some difficulty in reading the call.

At 1845 VK2OC and VK5RT contacted, beginning at R5 S9 but signals both ways began a rapid fade and within about five minutes faded right out. Other reports were VK5RV heard VK2ADT. VK5CU heard all three and called VK2BZ on phone with his key open. VK5QR heard VK2OC just as signals were on the way out. VK5BQ heard all three on a t.r.f. receiver—not super-regen either. At the Adelaide end VK5GF and VK5RT were using beams and VK5RV a half-wave vertical. At the Newcastle end VK2BZ and VK2ADT used beams and VK2OC a ground plane.

VK5LJ reports that American commercials are coming through on 40 Mc. at good strength.

Around this date VK3XA, VK3EH and VK3RR heard weak fading signals, which when they peaked and the voice could be copied, seemed to have a distinct American twang. No call signs were obtained.

On 12th and 13th October at 2115 to 2130 hours, VK3RR heard a weak signal on about 50.3 Mc., so called QRZ. After several overs like this, VK3RR managed to make out that a VK2 was calling him but signals then faded out.

VK3BQ, VK3RR and VK3VL are keeping a close watch on the 50 Mc. band all during each day and they also call at 1200 hours and 1500 hours.

Items of V.H.F. interest, personalities, DX, "bricks," etc., can be sent direct to VK3QO, 32 Redesdale Rd., N.21, Victoria. Include your name and address. To all our contributors, thanks OMs and keep up the good work!

### 50 Mc. JOTTINGS

The VK2 boys are still acting very coy and shy and will not send us any news, so we can't print it!

50 Mc. activity in VK3 appears to be increasing, perhaps due to the fact that the DX should be starting soon. Stations active include VKs 3RR, 3BQ, 3EH, 3BD, 3HK, 3VL, 3XA, 3LW, 3GE, 3KU, 3DH, 3ADF, 3HO, 3HT, 3BW, 3YJ, 3VZ in the suburbs, and 3GM, 3ZL and 3SE in Ballarat, and 3KX in Colac. These latter work Melbourne boys regularly.

In the North-West Zone 3TL, 3OA, 3BM and 3CE are after 522s and 3LU is very busy making a 50 Mc. rig. According to 3YW the Western Zone boys are getting busy as follows: 3GN is building a converter for 50 Mc. and hopes to take it to Maryborough on 9th November. 3TA and 3WC, in Horsham, are both all set on 50 Mc. Byron has a ground plane antenna, and 3WC a three element rotary, so any 50 Mc. signals tooting



round the wheat lands should be well caught. 3AKW at present has no gear but hopes to soon, so keep the idea brewing Bill. 3YW has been heavily infested with the bug, and built himself a super for 50 Mc., and at present has a 50 Mc. Tx spread out on a breadboard. Next idea is to compress it into a 7" x 5" chassis (crazy, he knows, but who cares) and also hopes to use Rx audio amp. as modulator.

On Sunday, 12th October a Field Day was held by the VK4 gang, operation being on 50 and 166 Mc. The function was arranged mainly as a means of introducing Ipswich Hams to 50 Mc. work and to try and coax some of them on to the band. VK4ES and party linked up with the Ipswich crew and carried out tests from the Minden-Marburg district. Contact was made with most of those on, although results were a little below expectations. Ipswich Hams present were VKs 4WS, 4KO, 4HG, 4MW and 4CH (hope that includes everybody). The usual crew was on in Brisbane with 4RT, 4KB and 4JY at Mt. Gravatt; 4CU at Toowoomba; 4XG, 4FB and 4ZU at Mt. Nebo, also 4AF was operating from Clifton and during the morning was putting in a beautiful signal at Mt. Nebo but no contact resulted, unfortunately.

Active interest is now being shown by several of the country stations in VK6. 6RL, of Northam, is on between 7 and 8.15 p.m. nightly one week, and between 8 and 9 a.m. daily on alternate weeks. Has not yet been heard in Perth but Ralph intends to get through or over the ranges even if he has to build a beam. A three element is already under construction.

Others reported to be active are VK6FN, of Pt. Hedland, and VK6WG and VK6HT, of Albany. If this report be true how about arranging some skeds with Perth via the 7 Mc. band? No news yet from VK6FB, of Mullewa, but Frank is probably too busy getting ready for this band to let us know how he is getting on.

Round the city VK6FC, VK6GB, VK6HM and VK6LW still active nightly and a newcomer, VK6MW, has joined the ranks. Does anyone know what's happened to 6BK or 6DD? Neither have been heard for many months on this band. Rumour has it that 6KW or 6DF may be joining 6LW on 166 Mc. He won't mind it!

No news to hand of 50 Mc. activities in VK7.

### 166 Mc. ACTIVITY

In VK3 the band has been fairly quiet only 3RR, 3AKI, 3LS, 3MM, 3MB, 3ACM and 3EM are active.

3ACM has got his big rig going on 166 Mc. Starting off with a 6SJ7 v.f.o. on approximately 1.75 Mc., Colin uses then a 6V6 doubler, another 6V6 doubler, then a 6L6, an 807 doubler into an 815 tripler which

## SUCH NICE PEOPLE

By "GREMLIN"

The shouting and tumult has barely died, smatterfact only reached about E layer, when smack in the peeper area arrives the thanks for Hams. Thanks from the I.T.C. at Atlantic City as a mark of world appreciation of Hams' war-work—minus 50 Kc. on 14 Mc. band. What's it matter if we do look like getting a fair whack of living space around 21 Mc. Twenty was our dog fight and how we loved it. I've never gone much for this ill wind business. Still, I don't suppose we can blame the powers that be in VK. They have handed us 50 watts and generally eased restrictions. That's something.

About this proposed shared portion on 14 Mc. What say we put all the VK2 AT20s in that area? That, plus a few W kilowatt jobs should hamper the propaganda and V emitters.

I guess you fell in like me. Bet I know what you thought about as you waded through mud, sand, tropical splendour and or files. Betcha it had something to do with the beaut gear you were going to get for next to nothing from surplus stocks. Did you too, pipedream about a beaut blonde fairy sliding up in a straight eight and saying "Thanks Hams, I guess we should encourage your games. Now help yourself first, it's nice and cheap and what's left can go to the big disposal wolves." I bet you did. It's even nice to think it's still not too late, although the wolf rides the straight eight.

And that Don, 2NO, is the reason I stopped at "Such Nice People." Where you take it up is just too

drives an 815 in the final with 50 watts input with about 65% plate efficiency. 3MB fits Ham activities in with building a house and swotting!

3GN and 3IQ, in the Western Zone, are building some simple 166 Mc. gear and intend doing some cross town work.

166 Mc. in VK5 is in the doldrums. 5JD has been obliged to build a receiver for 7 Mc., so he can hear some signals.

During the field day in VK4, 4AW, 4HR and 4TR were all heard at Mt. Nebo, a distance of 20 miles from Brisbane. This is the best work yet on 166 in VK4.

### 1400 Mc. AND ALL THAT

3QO has been testing his three 446Bs on a dynamic tester; result—two "goodies" and one definitely not so good. Moral seems to be to insist on having them tested before taking delivery. The plate currents of the three tubes were about the same so the trouble seems to be due to "spotty" emission. 3CU is reported as having five "lighthouses." Hope they are all good ones!

obvious—I've been shopping. You know Don, you have something with that "Honest Reporter" station and recorder business. Some blokes would get a shock if they heard their punk sigs returning, to say nothing about their technical statements. Or perhaps I should say, I hope they would be shocked. Yes, I agree, some blokes take a lot of convincing everything is not in order at home base. And don't think that technical "monkey chatter" is confined to VK2.

For the next few weeks blokes, you can splash and click and generally go to town in a big way—and probably get away with it. Truth is I'm doing a bit of revamping on the old receiver—I don't believe in fairies, 'specially blonde sorts. You may be unlucky in between vamps. These were.

2BT, solid hum spoils your phone. Clicks from 2YC, 3AHR, 3ZW, 2NH and 3LD. 4HG and 3IS splashing.

3SB, your quality is f.b., but you ooze a tiny bit outside the carrier on the low frequency side. You sound a particular sorta guy, so thought you might like to know. Some other's I wouldn't bother telling, they would not worry about such little things.

3LG is warming up for the CQ stakes. If you can't do better than 22 unbroken, retire OM. 3DN, a spot of downward modulation there I think.

Congrats 5KL on your fine 50 Mc. DX. There you are blokes, populate this band and do a spot of pioneering. It shouldn't be grabbed awhile yet.

So long for now patients, see you in some disposal joint, I guess.

## RADIOTRON RECEIVING TUBE CHARACTERISTICS CHART

The Radiotron Receiving Tube Characteristics Chart, issued by the Amalgamated Wireless Valve Co. Pty. Ltd., is one of the most comprehensive charts yet seen.

Published in booklet form 11" x 8" and containing 34 pages and lists almost every type of receiving tube made by A.W.V. as well as types manufactured by the American Company, ranging from the 1.4 miniatures to the latest 6.3 miniatures, as well as the loktal range.

The chart commences with a classification of Australian types followed by characteristics and ratings of Australian types. Then we have a complete classification of all types of Radiotron tubes, followed by a complete characteristics chart of all Radiotron tubes, and a socket connections chart.

The valve substitution directory is the most comprehensive list of possible substitution of practically every type of Radiotron receiving tube.

Amalgamated Wireless Valve Co. are to be congratulated on the matter contained in this booklet and the manner in which it is set out.

# EDDYSTONE

SUPPLIES YOUR EVERY R.F. NEED IN THE  
FIELDS OF F.M., A.M. and PULSE

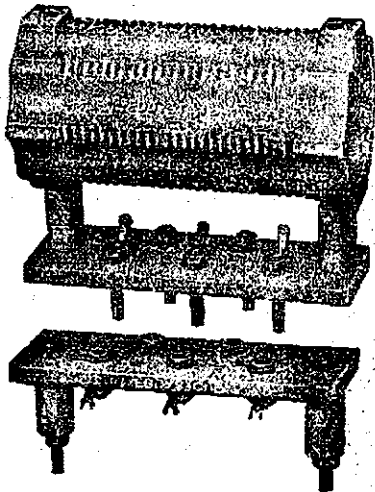

## FREQUENTITE COIL FORMER

Frequentite ceramic former for transmitting and similar apparatus. The former is 5" long by 2½" diameter, and may be mounted as illustrated or on Frequentite pillars. Spiral grooves take 26 turns of wire, up to 1/2 S.W.G. 14 holes are provided for leads and coil taps. The former is designed for coils covering 3 M/cs. upwards. Cat. No. 1090.

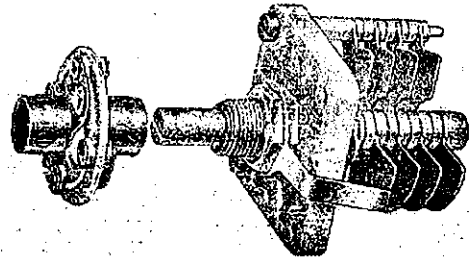

## BANDSPREAD TUNING ASSEMBLY

This outfit consists of a Cat. No. 529 Flexible Coupler and a Cat. No. 580 Air Dielectric Condenser of 15 pF. maximum capacity. The whole assembly is ideal for fine tuning and band-spreading purposes or for low powered transmitters.

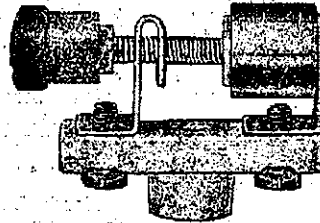

## NEUTRALISING CONDENSER

A miniature component for neutralising transmitters employing the popular types of low capacity triode valves. The rotor and stator are made of silver-plated brass, and are supported on a Frequentite mounting base. Fixing is by a single 4 B.A. Bolt. Minimum capacity 1.5 pF., maximum 4 pF. Flash-over voltage, 2,000 R.M.S. Cat. No. 481.

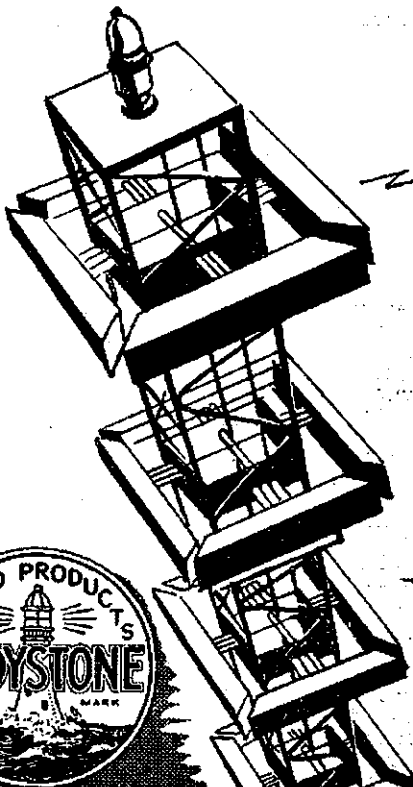

## DIRECTORY OF DISTRIBUTORS

- VICTORIA: J. H. MAGRATH & CO.  
208 Little Lonsdale St., Melbourne
- WEST AUST: CARLYLE & CO.  
Hay St., Perth & 397 Hannan St.,  
Kalgoorlie
- N.S.W: JOHN MARTIN PTY. LTD.  
116-119 Clarence St., Sydney
- S.A: GERARD & GOODMAN LTD.  
192-196 Rundle Street, Adelaide
- Q'LAND: CHANDLERS PTY. LTD.  
Cnr. Albert & Charlotte Sts. Bris.
- TAS: W. & G. GENDERS PTY. LTD.  
53 Cameron Street, Launceston

Australian Factory Representatives:

KEITH HARRIS & CO. PTY. LTD. 51 WILLIAM ST., MELB. Tel. MB2119

**EDDYSTONE** OFFERS YOU  
THE LATEST, MOST DEPENDABLE  
COMPONENTS for FM., AM., & PULSE



## DIVISIONAL NOTES

### NEW SOUTH WALES

Secretary: Peter H. Adams, VK2JX  
Box 1734 G.P.O., Sydney.

Meeting Place: Science House, Gloucester and Essex Streets.

Meeting Night: Fourth Friday of each month.

#### COALFIELDS AND LAKES ZONE

2TY now using a V beam on 28 Mc. and works 2ADX in Maitland on 166 Mc. Congrats on a YL junior op. — 2JZ, an old timer, threatens to make a noise again; making 28 and 14 Mc. beams. — 2VU, also from Singleton, on 7 Mc. phone, listens on 50 Mc. and works a few cross band, should be there shortly. — 2KZ still working Ws for a W.A.S. on 28 Mc., surprises the Yanks when he states the Rx is a 2 tuber. 2KF heard chasing the DX on 14 Mc., let's have some news. — 2PZ QRL and uses 7 Mc. phone during the week-ends. Only working on jobs for the higher frequencies. — 2MK inactive for past few weeks, building new rig and 50 Mc. converter. — 2ADT was in the break-through to VK5 on 50 Mc., also works 50 Mc. to Sydney and the Blue Mountains; a 3 element beam vertical or horizontal does the job. Was in VK phone contest and worked XE1A on 7 Mc. phone.

2YL regular again, 14 and 28 Mc. are the main bands, also plays with 50 Mc. 121 countries post-war, and for the worried ones, HSISS does QSL, also TF3A came to light.

#### WI BROADCASTS

All Amateurs are urged to keep these frequencies clear during, and for a period of 15 minutes after, the official Broadcasts.

**VK2WI, Sundays—**  
1100 hours E.S.T., 7190 Kc.  
2000 hours E.S.T., 50.4 Mc.  
No spot frequency checks will be available from VK2WI.

**VK3WI, Sundays—**  
1130 hours E.S.T., 7196 Kc.

**VK4WI, Sundays—**  
0900 hours E.S.T., 7100 Kc.  
0900 hrs. E.S.T., 14358 Kc.  
0900 hrs. E.S.T., 52,004 Mc.  
Frequency checks are given two nights weekly. Hours are announced during the Sunday broadcasts.

**VK5WI, Sundays—**  
1000 hrs. S.A.S.T., 7195 Kc.  
Spot frequency checks may be obtained from VK5DW on Friday evenings on the 7 and 14 Mc. bands.

**VK7WI, 2nd and 4th Sundays—**  
1030 hours E.S.T., 7174 Kc.  
No frequency checks are available from VK7WI.

— 2OC on 50 Mc. nightly from 7 p.m., broke through to VK5. — 2TX is ready for a comeback. — 2RU is regularly on 50 Mc. — 2AEZ mainly on 14 Mc. and getting ready for 28 Mc. — 2AIO mainly on 14 Mc. too, how about some news o.m. — 2KR on 7 Mc. phone. — Any notes from the Gosford area would be appreciated.

#### WESTERN ZONE

2BT most improved station this month. Built field strength meter, pruned antenna, and rehased Rx. — 2WH still working DX on 14 Mc. and has a V beam which is not too good as yet. — 2II is using co-ax vertical on 28 Mc.; to quote Max: "Weak in all directions." — 2NS has re-designed shack, everything in its place (how long?). — 2ACU now at Coonamble working DX on 8 feet wire as an antenna. — 2AMR still working DX on 14 Mc. — 2HZ is shifting to new shack. Rx should be finished for 1950 VK DX Contest! 2LZ heard on 7 Mc. and xtal controlled. We are worried Con, why xtal? — 2LY re-building everything, some more power? — 2QA has new house and should be heard more in the future.

#### N.S.W. ZONE OFFICERS

North Coast and Tablelands: 2AFP at Casino. Newcastle and District: 2FP at Hamilton. Coalfield and Lakes District: 2YL, Cessnock. Western: 2QA, Nyngan. South Coast and the Tablelands: 2ANN, Bega. Southern: 2OJ, Albury.

## VICTORIA

Secretary: A. E. D. Evans, VK3VQ,  
Box 2611 W G.P.O., Melbourne.

Meeting Night: First Wednesday of each month.

Meeting Place: Radio School, Melbourne Technical College.

The Victorian Division desires to advise that the official weekly broadcasts of VK3WI of news, activities and items of interest to all Radio Amateurs will be each Sunday morning at 1130 hours E.S.T. on a frequency of 7196 kilocycles. This schedule will be adhered to until further notice and it is further advised to listen for any additional broadcasts as advised by the communications manager and operator of VK3WI, Mr. A. E. (Arthur) Tinkler.

Monthly activities in Melbourne have been marked by much important business and decisions on the part of councillors and members concerning this Division. At a special Council meeting held late in September, to debate the ways and means of appointing a full-time paid secretary to handle the business of the Division, it was found that owing to the in-

ability of financing a male secretary it was resolved to recommend to the October general meeting that a female secretary be appointed at a salary of £5/10/- per week plus 5% on all subscriptions. Later in the evening the necessity for increasing subscriptions to help meet a paid secretary's salary was discussed.

The general meeting held on 1st October admitted several new members and after correspondence had been dealt with Mr. R. H. Cunningham (3ML) in the chair, introduced Mr. H. Kay, of the P.M.G.'s. Depart-

## Australia's Largest Stock of All Radio Components

Chokes  
Coils  
Condensers  
Dials  
Intermediate Transformers  
Mose Equipment  
Potentiometers  
etc., etc.  
Resistors  
Soldering Irons  
Speakers  
Test Equipment  
Valves  
Pick-Ups  
Power Transformers  
etc., etc.

Obtainable from

## Bloch & Gerber Ltd.

with which is associated  
the

### WELDON ELECTRIC SUPPLY CO.

46-48 YORK STREET,  
SYDNEY

G.P.O. Box 2282 M

Phones: MA 6291 (10 lines)

ment, who gave an interesting talk (illustrated with slides) on the subject of Frequency Modulation.

During general business the Council's recommendation for a female secretary was put to the meeting and members expressed their conformity of opinion to the absolute necessity for this appointment, and on a motion, the meeting carried this important decision (there being only a few dissenters). The matter of increasing subscriptions was then partly discussed and for want of time was left over for discussion at a later date.

Council at a following meeting voted a grant of £75 to the Technical Advisory Committee for the construction of a Test and Demonstration Bench in the Institute Rooms. This is the first project in their plan for installation of modern technical equipment. A further grant of £50 was voted for immediate purchase of some items of essential equipment.

Promise of a great deal of further interesting and most useful disposals gear becoming available was outlined by Mr. H. Kinnear (VK3KN) and Council confidently gave the OK for the purchase of gear to be made available to members.

Further details of disposals gear will be announced from the weekly broadcasts of VK3WI.

**TECHNICAL ADVISORY COMMITTEE NOTES**

**Executive.**—At the last meeting of the T.A.C. Executive, a discussion on budget for future laboratory equipment was held, and it was decided to submit to Victorian Council a list of equipment and instruments recommended for a two-year period. The meeting is each third Tuesday.

**V.H.F. Group.**—A discussion on various types of V.H.F. receivers was conducted at the last monthly meeting of this group. VKs 3EM and 3LS brought along super-regen. receivers and a great interest was taken in a V.H.F. band-switched converter built by VK3VZ. This converter was switched for 28, 50 and 166 Mc. and will be the subject of an article in "Amateur Radio" in the near future. VK3XA produced some absorption type wavemeters, which cover from 50-400 Mc., and indicated that these would be made available for laboratory and members' use. 3XA is to be commended on his prompt action in securing these meters for T.A.C. use. Meeting: 2nd Wednesday.

**Receiver Group.**—Mr. George Neilson continued his discussion on selectivity in receivers at the last meeting of this group, which was appreciated by all present. At the next meeting, Mr. Ivor Morgan, VK3DH, is to present a lecture on ways and means of coupling antenna and receiver for maximum signal to noise ratio. This should prove to be an excellent night, so don't miss it. Meeting: 4th Wednesday.

**WHERE EXTREMELY HIGH ACCURACY IS DEMANDED**

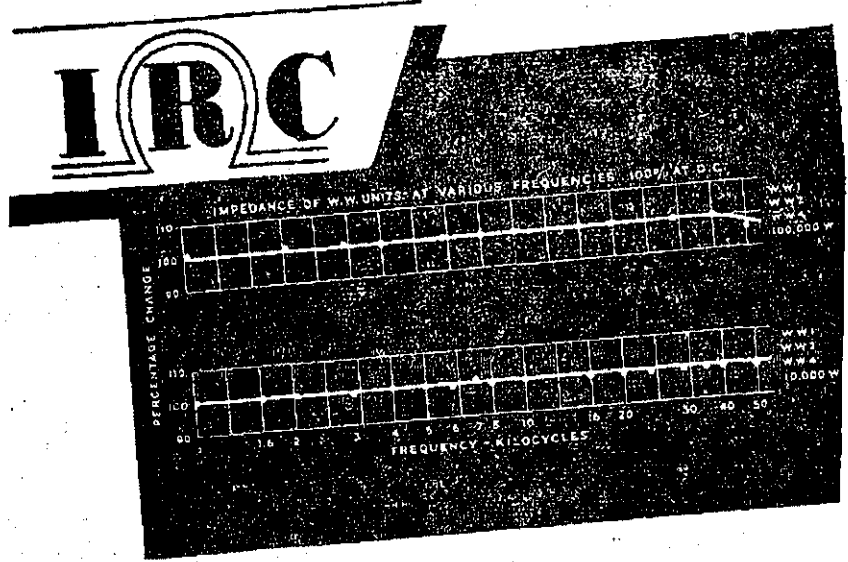

**PRECISION WIRE WOUND RESISTORS**

Available in all Resistance Values up to:

They have been developed to meet the exacting demand called for in Talkie Equipment, Multipliers and Shunts for Meters, Attenuation Controls, and all applications where low temperature co-efficient, stability and a high degree of accuracy are essential.

Because of the special sectional construction and impregnation, which permit the winding of adjacent sections in opposite directions, a non-inductive winding of low distributed capacity is made possible. The impedance characteristics of these units are practically uniform and independent of frequency up to 50,000 cycles, as shown in graph above.

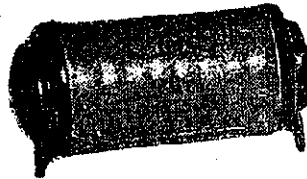

WW2 to 1.3 meg.



WW5 to 750,000 ohms.



WW4 to 350,000 ohms.



WW3 to 125,000 ohms.

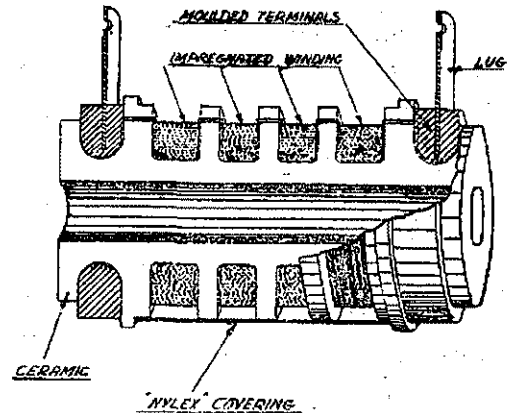

Sole Agents for Australia:—

(Note new Telephone number)

**Wm. J. McLELLAN & CO.**  
BRADBURY HOUSE, 55 YORK ST., SYDNEY • PHONE BX2508

**Modulation Technique Group.**—Mr. Bob Sandon, VK3ABS, is to deliver a lecture at this group's meeting on equipment suitable for Narrow Band Frequency Modulation on the 27 Mc. band. All interested in phone and the new releases of f.m. and pulse are invited to come along to these meetings. Meeting: 3rd Wednesday.

**General Meetings.**—A most interesting lecture on Frequency Modulation was given by Mr. Harry Kay, of the P.M.G.'s. Department at the Oc-

tober meeting of the Division, and was appreciated by all in the manner it was presented, with the aid of Strip Film diagrams. The lecturer proceeded from the fundamentals of f.m. to the more complex nature of the subject, but it is felt that all who were present, will have a much better appreciation of the subject and its potentialities than before. It is hoped to be able to publish the substance of this lecture in "Amateur Radio." Mr. Moriarty, of the P.M.G.'s. Department, is to lecture on Propagation at the November meeting of the Division. Meeting: 1st Wednesday.

#### NORTH-WEST ZONE

The Secretary has sent round a newsletter to every zone member and a request for personal pars. In accordance with the convention resolution that we endeavour to arrange for a car load of our members to attend adjoining zone conventions, we are arranging for a car to go to the Central Western Zone meeting at Maryborough in November. Members interested, please contact 3TL.

The new 14 Mc. 3 element rotary at 30A exhibits excellent directive characteristics on the Rx, but Ian's XYL (Jean) claims that the prospects of the strawberry crop are down about 3 db since the said beam was erected above! Ian is planning a new Rx for 14 Mc. — — — 3CE has installed a new antenna coupler, cut so as to be self-tuned, and it has improved his transmission to a marked degree. — — — 3TL is making steady progress on the 28 Mc. outfit. Treb tried 14 Mc. during the month but decided a pre-war Rx was N.G. on the post-war band. Has replaced his 801s with 809s for 100 watts. — — — 3BM has got his big V beam going on W land on 14 Mc. and is usually reported "strongest VK phone on the band." Bruce is still looking for another mile of wire to finish the antenna system of 11 33-degree Vs, 840 feet per leg.

#### WESTERN ZONE

Western Zone hook-up took place on Sunday, 12th October at 10 a.m. (7050 Kc.). Stations reported were 3GN, 3YW, 3EP, 3AKW, 3ATR, 3IQ and 3AGB. Main discussion centred on the next convention and the proposed increase in W.I.A. fees.

The next convention is to be held at Maryborough on Sunday, 9th of November. The main event will be a 50 Mc. field day, which should tie in nicely with the 50-166 Mc. Field Day in Melbourne. Consideration will probably be given as to the advisability of having more field days and less conventions in the zone as it is hard for members to get from one end of the zone to another.

In reference to the proposed increase in W.I.A. fees to cover the cost of a paid secretary, while it was felt that the increase was inevitable, and the appointment of a paid secretary very necessary, we considered

that the country member was being treated harshly by bringing his fees to the same level as the city member. He does not, and cannot, get the same service from W.I.A. as his city brethren and so does not feel disposed to pay the same fee. The proposed refund of 5/- per member to finance the zones was considered far too high, 2/6 will finance this zone (N-W zone consider 1/-) easily.

3GN had a glorious hum on his carrier during the zone hookup; better park that "108" v.f.o. on the shelf George. — — — 3IQ is making the most of his new call and has some ideas for us re R.S.G.B. food appeal.

— — — 3AKW has scrapped his cathode modulation and put in plate modulation, carrier much cleaner.

3AX very busy at present, and not too much time for radio, however is still knocking a few off on 14 Mc.

— — — 3EP is very thrilled to get a South African QSL, this makes him W.A.C., congrats. — — — 3YW while testing the transmitter blew a fuse, examination disclosed what had been a nice big spider parked across the plate by-pass condenser. — — — 3ATR, 3WC, 3TA and 3AGB are a bunch of busy blokes with nothing to report, so no notes mean more yarns!

Well gang that's all the doings this month, we hope to see you in person at Maryborough next month when maybe that villain, Willy (3XC), will arrive so the important things to remember are:—

1. Convention to be held at Maryborough, 9th November.
2. Build and bring 50 Mc. gear to Maryborough for the field day, and help the boys with V.H.F. ideas.

#### "FOOD FOR BRITAIN" APPEAL

The Committee have, since the last notes, despatched another 25 food parcels, now making the total 150. Parcels are arriving at regular intervals in England, and R.S.G.B. HQ are being kept very busy balloting for and re-distributing them. The Committee have received many letters from grateful recipients, which for want of space, we are unfortunately able to publish. We can only say that each and every lucky one all wish to convey their deep and sincere gratitude to all concerned. We hope that donations will not fall off, but will continue to roll in with undiminished regularity.

We are very pleased to announce that Radio Corporation Pty. Ltd. have generously donated one of their new model broadcast receivers to the Committee, to be included in the big raffle we have previously made mention of. We here wish to record our gratitude for their most magnanimous gift.

At the last General meeting, a type T1092 transmitter and a Taylor T20 triode were raffled, and the draw was made by our lecturer, Mr. Harry

# Bright Star Radio

VK3UH

1839 LOWER MALVERN ROAD

GLEN IRIS, S.E.6, Vic.

Phone: UL 5510

TAYLOR TRANSMITTING  
TUBES

Full Range

Crystals as illustrated.



40 and 80  
metre.  
AT or BT  
cut. Accu-  
racy 02% of  
your  
specified  
frequency.  
£2/12/6

20 metre zero drift, £5.

Crystals Reground, £1 each

**SPECIAL!**

**BENDIX FREQUENCY  
METRES.**

Complete with calibration  
book, in perfect order.

Know your frequency within  
cycles. The ideal V.F.O.  
£30 each

Meter Scales suitable for Pullin  
disposal meters, Multi Meter and  
Volt-M.A. 6 H.M. available, 2/-  
each, post paid.

Screw Type Neutralizing Con-  
densers (National Type) to suit  
all triode tubes, Polystyrene insu-  
lation, 19/6 each.

Kay. The T1092 was won by Mr. T. B. Clarke and the T20 by Mr. W. H. Ross, and yielded the sum of £10/7/-. The usual box collection, although not as good as previous meetings, realised the sum of £6/13/9, making the total for the night £17/0/9. The total receipts are now £173/16/2, expenditure on parcels £137/10/7, and cash in bank and hand £36/5/7.

Please contact your Zone Organiser regarding details of raffles, donations, etc. They will be pleased to receive your donations however small—every little helps. The organisers are as follows:—

N-E Zone, Howard Wohlers, 3YV.

N-W Zone, Ian Adams, 3OA.

C-W Zone, Kevin Duff, 3IQ.

S-W Zone, Bruce Plowman, 3QC.

East Zone, Graham Colley, 3QZ.

Watch these notes for details of the big raffle.

## QUEENSLAND

Secretary: R. Thorley, VK4RT, Box 638J, G.P.O., Brisbane.

Meeting Place: State Service Building, Elizabeth Street, City.

Meeting Night: Last Friday in each month.

There has been nothing of any special significance happen in the VK4 Division during the past month, unless it be 4AP's fine effort in WAC-ing in less than two hours during the

DX Contest on 28 Mc. 4RC has also been in the thick of it, and reports fairly good conditions on the band.

Whilst speaking of DX we received a letter from ex-VK4PR, on Guam with the U.S. Forces, in which he enthused over the gear in use over there, and also passed on the information that anyone waiting for cards from KG6AV/VK9 need not have any fears—the QSL situation is well in hand there. He reports that VK4 signals seldom seem to get through over there, but he would like to have a yarn to any of the boys whenever he does get the chance on 14 Mc. A letter from the following would also be welcomed—VKs 4KG, 4TR, 4PD and 4VJ. His address is W. J. Rafter, Box 467, Marama, A.P.O. 284, Guam.

In response to 4FN's appeal for contributions to the Food for Britain Appeal the fund received a boost, the amount in hand for the next shipment being £13 of which £3/10/- was collected per medium of the hat passed round for a "bob-in." With 38 members present, my arithmetic may seem screwy, but at least the error is on the right side of the sheet.

As a variation from the auction sale of last month, two Disposals receivers were balloted for, the winners being 4KB and 4AU. Six racks also went off in the same manner, the demand far exceeding the supply.

Incidentally, ALL members have been circularised about this material, so any hold up, etc., has been in the mail. We hope to take delivery of some 522s before this appears in print, but apart from these items we are still in the dark as to other gear.

As September marked the end of six months service by the present Council, Secretary 4RT presented a detailed account of our position, and following are some of the more important items. The membership has increased from 69 to the present record of 143, made up of 71 City full members and 10 Associate members, and 58 Country and 4 Associates. There are in addition 7 members awaiting election. (The 150 mark has been left behind since these figures were compiled.) The financial position has likewise expanded from a credit balance of £10 (AFTER the delegate's expenses had been paid) to a credit balance of £45, plus the addition of a duplicator to the Institute's assets. General Revenue was £82, whilst the Disposals receipts amounted to £626.

The activities of the various departments was recounted, comprising QSL, Library, Station Manager, and Publicity, whilst the meeting was reminded of the services of the Traffic Manager "whose punctuality for receiving and passing traffic when most of us are asleep calls for special mention." Finally in closing, the

# TECHNICAL BOOK & MAGAZINE CO.

297-299 SWANSTON STREET, MELBOURNE

(Opposite Old Melbourne Hospital)

Central 2041, Melbourne, C.I

We can arrange subscriptions to any of the following magazines:

### AMERICAN.

AUDIO ENGINEERING	27/- year	COMMUNICATIONS:	24/- year
Q.S.T.:	27/- "	RADIO NEWS:	40/- "
C.Q.	25/- "	RADIO CRAFT:	22/- "
SERVICE:	24/- "	SCIENCE DIGEST:	23/6 "
F.M. & TELEVISION:	48/- "	PROCEEDINGS INST. OF RADIO ENGINEERS	104/- "
ELECTRONICS	97/6 "	POPULAR SCIENCE:	23/6 "
SPECIAL RATE FOR THREE YEARS	195/- "	POPULAR MECHANICS:	23/6 "

### ENGLISH AND AUSTRALIAN.

WIRELESS WORLD:	25/- year	WIRELESS ENGINEER:	42/- year
PRACTICAL WIRELESS	10/6 "	ELECTRONIC ENGINEERING:	33/- "
AUST. RADIO WORLD:	10/6 "	RADIO AND HOBBIES:	6/6 "
AMATEUR RADIO:	6/- "	SHORTWAVE MAGAZINE (English):	25/6 "

FOREMOST IN AUSTRALIA FOR TECHNICAL BOOKS.

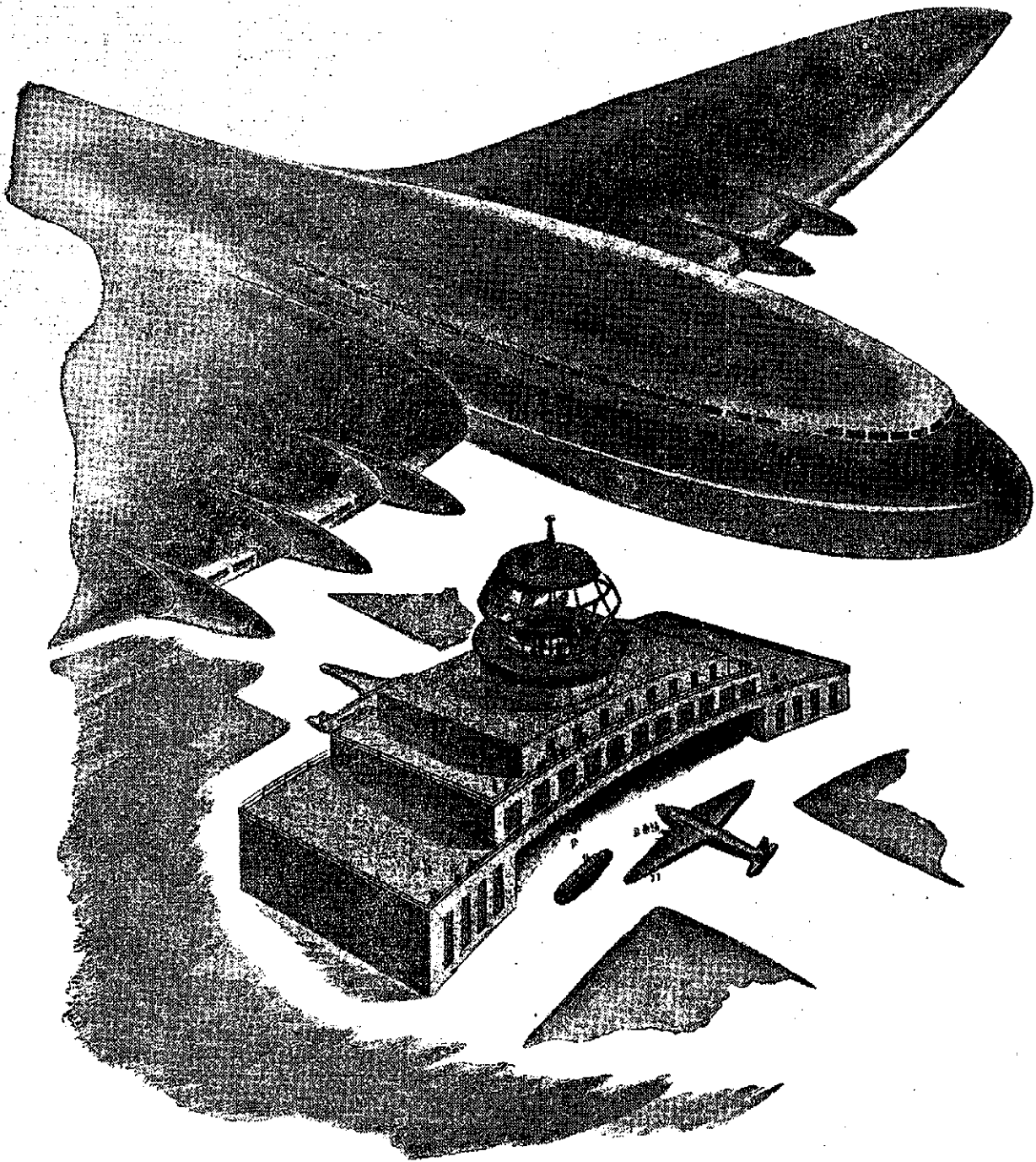

# Success Aloft

The vision of Jules Verne, whilst encompassing the marvels of air transport, passed without comment the essential factor of communication.

Through electronic valves and their application emerged Radar to penetrate the darkest night and the densest fog; beacons to provide directional beams to airports; compasses to aid navigation when visibility is nil; contact with ground control—instant, certain.

And the same Radiotrons, so consistent and efficient as silent sentinels to aircraft safety, provide unsurpassed quality to radio in all its phases.



**AMALGAMATED WIRELESS VALVE COMPANY PTY. LTD.**



Secretary thanked all for their efforts and expressed the hope that even greater efforts were called for if the present progress was to be maintained. The part played by 4WI in rebuilding the Institute was a landmark in the history of this Division, thanks to the untiring efforts of operator VK4FN.

Later in the evening those present were regaled by a lecture on "Airborne Radar," presented by Mr. J. Wheller. If "Regaled" does not seem the right word in the above sentence,

it is explained by the fact that you were not present to hear Johnny's lecture. Discussion took place regarding the Annual Dinner, and it was decided to move the date of same forward slightly in order to relieve the new Council of the responsibility for organising the function. At the moment it seems that the Dinner will be held in January or February which is a month or two earlier than usual.

After a great deal of discussion at the last Council meeting, the prize for the VK4WI QSL design was allotted to VK4RF whose entry met with the approval of the majority of Councillors. Congrats Fred, and how is Dalby getting along? All going well you will have received your prize of One Guinea ere you read this.

During the month of September we received a visit from Mr. Harry Kinnear (VK3KN), a past President and Disposals Purchasing Officer of the Victorian Division. A pleasant evening was spent by several Council members discussing various points of mutual interest to both Divisions, and Mr. Kinnear promised this Division help in Disposals purchases for either Division or both if necessary. All in all, the excellent relations between both Divisions were further enhanced as a result of 3KN's visit.

In closing we present once again the times and frequencies of VK4WI. Transmissions are conducted simultaneously on three frequencies in the 7, 14 and 50 Mc. bands, the spots being 7100, 14358 and 52004 Kc. The writer can't vouch for the exact frequencies, but they are pretty close to those given. Time of operation is 0900 hours on Sunday mornings, when announcements are made as to times for Frequency Checking Services for the ensuing week.

## SOUTH AUSTRALIA

Secretary: E. A. Barbier, VK5MD,  
Box 1234 K, G.P.O., Adelaide.

Meeting Place: 17 Waymouth Street,  
Adelaide.

Meeting Night: Second Tuesday of  
each month.

The general meeting of the S.A. Division was held on Tuesday, 14th October, when Frank Wreford (5DW) and Gordon Bowen (5XU) gave a very interesting and instructive practical demonstration of "Frequency Measuring." Frank was in charge of instruments and Gordon gave the commentary, the two combining very well together and never looked at any time like coming to blows.

The lecture-demonstration commenced with the simplest method of frequency measuring, to wit, the simple absorption meter and from there to a calibrated receiver, next to a heterodyne meter to which a crystal was then added, thus arriving

to what is known as secondary standard calibration. A practical demonstration using WWV as a means of calibration checking was then given, after which Frank demonstrated the technique of frequency measuring as used by him on Friday nights as custodian of the frequency meter.

Opportunity was taken to demonstrate various crystal holders and the effect on frequency arising from different pressures and types of holders. Most of the audience shuddered every time Gordon said casually "drop the xtal in that holder Frank," and would have preferred to have heard him say "place that xtal gently in the holder Frank." An audible demonstration of a "creeping" crystal was then given and this portion of the lecture closed with a description of a Bendix frequency meter which was appreciated by all present.

At this stage to facilitate several experiments with a c.r.o., the lights were extinguished, which was a decided let up for me as I could not see to write any further notes (you beaut!), but I can say that this portion of the lecture was followed by all present with considerable interest. The lecture concluded after this and a vote of thanks was proposed by Pete Bowman (5FM) who said that the outstanding part of the lecture was the clearness with which the many points of interest were presented. Judging by the applause which followed the vote of thanks, the members present were in agreement.

Among the visitors at the meeting were W. Marshall (2XM and 2XS mobile) of the M.V. "Momba" which was in port on the day of the meeting.

The xtal used in the "creeping" demonstration was loaned by Dougall Whitburn (5BY) who reluctantly admitted ownership when challenged. If that crystal only "crept," I can do 100 yards in even time!

The desirability of listening to 5WI every Sunday was again demonstrated on the holiday week-end of October. Short notice from VK3 regarding supplies of co-axial cable necessitated an urgent reply to secure delivery. No time was available to contact the members individually so details were broadcast over 5WI. The response was gratifying but several Hams missed out entirely due to not listening to 5WI. As usual all the hard work of organising, etc., was shouldered by "Doc" (5MD) and when I visited him on Tuesday and knocked on the office door I heard the whirr of a grindstone and was in time to see the removal of the Barbier nose from it. Men like him get too little kudos.

It is with regret that the S.A. Division reports the untimely death of W. G. Brett (5WB). Members at the general meeting observed a one

# Low Drift Crystals

FOR  
**AMATEUR  
BANDS**

ACCURACY 0.02% of  
STATED FREQUENCY

3.5 M/C and 7 M/C

Unmounted .. £2 0 0

Mounted .. £2 10 0

12.5 and 14 M/C Funda-  
mental Crystals, "Low  
Drift" Mounted only £5.

Spot Frequency Crystals  
Prices on Application

Regrinds . . . . £1 0 0

THESE PRICES DO NOT  
INCLUDE SALES TAX.

## Maxwell Howden

VK3BQ

15 CLAREMONT CRES.,

CANTERBURY, E.7.

minute silence as a mark of respect to their late member, and the secretary also conveyed to the relatives, by letter, the sympathies of the W.I.A.

Bill Baker (5BQ) was lamenting at the meeting as he received a QSL card from China with a decent surcharge for incorrect stamping. What was making Bill "winge" was the fact that he had already sent three cards to the particular Ham. Almost as cheap to use the telephone eh Bill!

The field day is on the go again and Ted Cawthron (5JE) is forming a committee. Last year's day will take beating Ted.

I suggest that during all lectures the programme arranger, Gordon Bowne (5XU), wander among the audience (as judging by the odd one or two who kept up an incessant "yabber jabber" explaining their viewpoint of the circuits, experiments, etc.), some good talent is going to waste or could it be that they are not as clever as they would like to sound. "Waxboring" is the technical name for it!

Judging by the gang lined up to pay their subscriptions at the meeting the treasurer, Cec. Baseby (5BZ), must have required a police escort after the meeting.

It appears that a paragraph in this column regarding Council members and supposed disposal equipment did not meet with the approval of some VK3 members. This is to be regret-

ted because the said paragraph was intended only as a satirical attempt to break down the foolish ideas of a small minority in VK5 who believed that Council members had the "open sesame" to disposals equipment. Had I been aware that my humble efforts were being perused by interstate readers I would have worded the paragraph quite differently to conform with interstate sense of humor. I would also have applied for a rise in salary having enlarged my circle of readers. My friend "Quentin" once told me that when one became a correspondent from a duty and no salary angle, one deserved to be criticised. May be he was right.

It has been suggested that I write a few things about some of my Amateur friends in an endeavour to brighten up this column. When I suggested that if I wrote some of the things I know about my Amateur friends, I would not have any friends for long, nobody appeared very concerned. Taking my tools of trade, a well-chewed pencil and a bullet proof vest I sallied forth and can now report—I know that:—

George Ramsay (5GD) and Frank Wreford (5DW) were heard on 28 Mc. recently telling each other just what they would do to the DX when it broke through and during the three hours they were tied up together, signals from practically all parts of the world were coming in at S9.

Ross Harris (5FL) has an automatic CQ caller which he switches on

whilst he makes his early morning cup of tea. I also know where some of the material, of which it is constructed, came from. Naughty!

Doc Barbier (5MD) sold the idea to a VK5 Ham to come down to 28 Mc. and then calmly "pinched" all the DX from under the said VK5 Ham's nose.

Bert Brooks (5KG) is using an S9er and is more than pleased with it, and the same goes for quite a large number of VK5 boys.

A good many VK5 boys are not very truthful with their reports on signal strength and quality. Misleading reports do more harm than good and no regular guy will take exception to true and helpful reports.

Gordon Bowen (5XU) is Church Organist at Kent Town Methodist Church, but that fact does not prevent him from using the same sort of language all Hams use when local QRM rises to a peak just as the DX starts rolling in.

One or two of the VK5 boys on 28 Mc. are over-modulating at times, and as they can work all the DX they want without over-modulating, it all seems so unnecessary.

The Secretary and Treasurer put a whale of a lot of work into the W.I.A. at the end of each year, especially with some of the "dillpots" who apparently think that a reply to their letter should be posted twenty minutes after the Secretary receives it.

**RED  LINE**  
**EQUIPMENT FOR THE AMATEUR**

**INCLUDES:**

- High Tension Plate Transformers
- Low Tension Filament Supplies\*
- Class B Driver Transformers
- Multi Impedance Modulation Transformers
- Heavy Duty Power Supplies
- Swinging and Smoothing Chokes
- Wide Range Audio Equipment
- Frequency Dividing Networks

\* Insulated up to 4000 volts if required

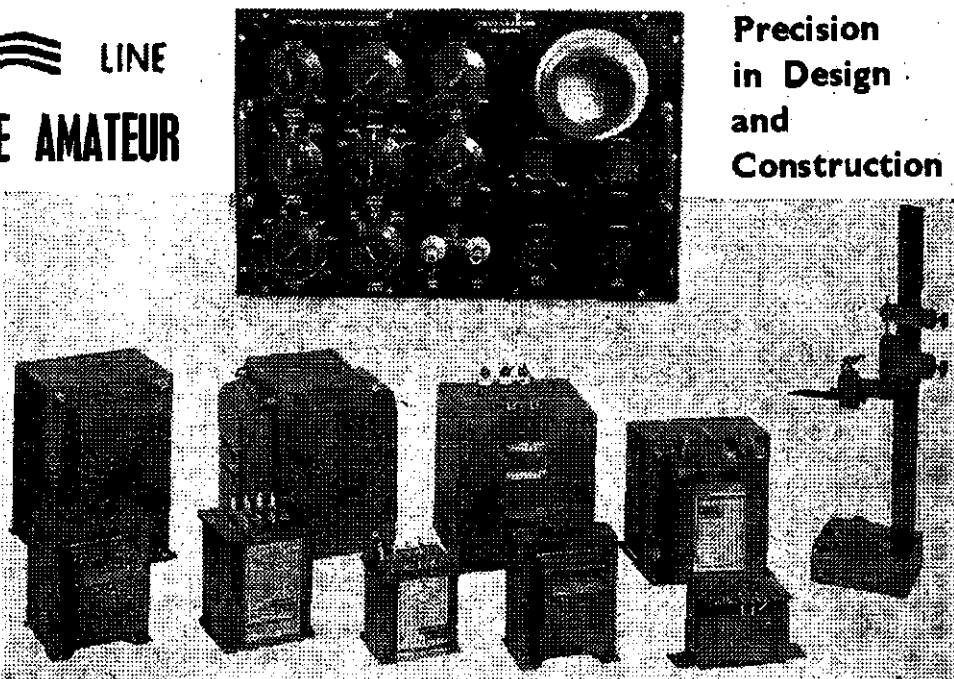

**Precision  
in Design  
and  
Construction**

**SWALES & SWANN**  
 And Leading Distributors

Workshops:  
 2 Coates Lane,  
 Melbourne.  
 Cen. 4773.

City Office:  
 157 Elizabeth St.  
 MU 6895

## WESTERN AUSTRALIA

Hon. Secretary: W. E. Coxon,  
VK6AG, Howard St., Perth, W.A.  
Meeting Place: Builders' Exchange,  
St. George's Terrace, Perth.  
Meeting Night: Second Monday in  
each month.

The October meeting, held on the 13th of the month, was an outstanding success. The attendance was larger than ever before, seating accommodation being all taken and tables had to be pressed into service. This speaks well for the manner in which the monthly meeting night is being conducted.

The business was dealt with promptly and advice was given members that their orders for SCR522A Transceivers, ex-Queensland Division were to be fulfilled. This was welcome news to those having orders in for them, especially coming on top of the recent purchase of Bendix Transmitters, and receivers locally. A limited number of Petrol Generator sets were also available for those who had ordered them.

The general business section was followed by firstly a continuance of 6LW's talk on frequency modulation. This was followed closely by all present and proved most interesting. 6AG then gave a demonstration of the latest Flying Doctor Transceiver which had included more new and some very interesting constructional changes departing from the conventional. This concluded the meeting with everyone looking forward to the next.

### PERSONALITIES

6BW is back in town once again. Mick is like the proverbial "Flea in a bottle"—here, there and everywhere. — 6TX is a dark merchant these days. Not seen or heard of for several weeks. — 6WL is back in Brookton after a visit to the Nullabor Plains. Paid us a flying visit when in Perth. Les also seems to have other interests apart from Amateur Radio. — 6AH has been on a well-deserved holiday. Stan was even off the string, having left 6MH holding the fort at Wiluna. — 6AL, a call not heard post-war yet. Arthur tells us he has been listening to the 7 Mc. gang on his new midget Communications Receiver model MCR1, and reports excellent reception of Perth Hams at Bunbury.

6KE has at last seen the light and has constructed a 28 Mc. wide-spaced rotary beam and was heard working some good DX with it too. — 6RU heard going great guns in the DX phone contest. We believe he did pretty well too. — 6HL is another, consistent 48 hour non-sleep bird, calling "CQ Contest" and doing fine. — 6FL is always there when contests are around. — 6KW, one of those that gave the DX away during contests. A busy man

on ex-disposal Bendix gear. — 6DF also keen on converting disposal gear to Ham uses. We believe that Maurie is getting together a f.b. portable outfit. — 6YZ is a consistent 7 Mc. enthusiast, keeping the 7 Mc. band warm.

6DD back on the air again after an absence of three months. John has a super v.f.o. and we believe it really works. — 6LM a real local rag-chewer: lately. What's wrong with the DX bands Lionel? — 6WH fairly quiet of late and we are wondering what Ted is up to. — 6WS making structural alterations to his beams. With his new S9er, "Skipper" should really go to town this summer. — 6MO heard and worked by many on 7 Mc. Watheroo Observatory is really on the map as a Ham station these days.

6HT has a combination of a two element beam atop a 35 feet steel tower with a homebrew v.f.o. that really works. Harry sure goes places on 14 Mc. but just can't make that South American for W.A.C. on that band. — 6WG is mainly active on 7 Mc. at present with occasional bursts on 28 Mc., but is working on some 50 Mc. gear. Intends cross country tests with 6HT on 50 Mc. early in October. Both have their receivers down on 50 Mc. and are keeping an ear out for city signals. — 6EC, at Wagin, also interested in 50 Mc. work. At present active on 7 Mc. with a modified FS6. — 6DX paid us a visit to Perth for the October meeting. Bill gave us all the dope on the Goldfields doings.

### DX OF THE MONTH

28 Mc. Phone.—This band, during this last month, has provided more DX entertainment than it did last summer, and if those Hams who are considering getting on this band read this article through, they will then probably get there sooner. W.A.C. has been made on two Sundays during the month and on the 21st all Continents were worked in just under two hours; so get up on to 28 Mc. you DX fiends and give VK6 some more publicity.

Europe.—Practically every day the band has opened to this Continent from about 1600 to as late as 2200 occasionally, and has provided more QSOs than any other Continent. From England the Gs have been too numerous to mention and many of them have had signals well over S9. GI7UW, EI3J, F8ZW, F8XT, F9FB, F3TA, F3KH, F8NT, F3GL, D4AOM, D4ADT, D4APN, D2SP, OI2KAJ, LX1SI, LX1MS, LX1JW, I1SM, I1MH, W2VJW/Portable Istanbul (Turkey), ZB1AC, OZ5KW, OZ4PB, OX7CC, PA0UN, PA0FB, PA0OO, PA0AN and SM5WJ have all been good contacts.

North America.—The Ws have been putting in an appearance during the mornings from 0700 to 1200 but

working them has only been spasmodic, i.e. week-ends and prior to 9 a.m. some mornings. W5, W0, W6, W7 districts have been the most prominent. VEs from Canada have been absent and the only Alaskan contact was KL7LO.

Central America.—These chaps have proved most elusive and the only few worked were YN4DT, KZ5OJ and CO2JV.

South America.—Sunday mornings from 1030 to 1230 seem to be the best times for turning the beam south and

## CHASSIS — RACKS — PANELS

Any size, any gauge. Write enclosing full particulars. Quotation forwarded by return mail.

## METER SCALES

Suitable for Pullin "Disposal" meters. Volt-M.A.-Ohm or special Multi-meter scale. Either type, 2/-, post free.

## POWER TRANSFORMERS

Wound on extra large core. Any voltage or amperage—Reasonably priced. 7-DAY DELIVERY SERVICE

Multi-Match modulation Transformers. 75-watt. In die-cast metal clamps. Write for full details. £4/19/6. DELIVERY EX STOCK.

O—.5 Amp. Thermo Ammeters, 17/6

VK3NU

## Major Radio & Electrical Co.

189 GLENFERRIE ROAD,  
MALVERN

WM 1814 U 9354

for three week-ends of the month the band opened. CE1AH has had by far the best signal and the others worked were HK3EO and HK3DW.

**Africa.**—This Continent is becoming more 28 Mc. minded than last season and the ZSs from the Union have been in the majority, the number being worked far too numerous to mention. Many new friends are being made and many of the old contacts from last summer are being repeated. CQ5BA, CQ5AR, VQ3PYE, VQ3EDD, VQ4NSH, VQ4ERR, VQ2PL, ZE2JA, ZE1JH, W3KIF Maritime Mobile in Tanga Harbour (Tanganika) and W2SXW Maritime Mobile working along the west coast of Madagascar, all proved most interesting QSOs. ST2MP (ex-VS9AP), ST2AM, ST2FT, SU1WS, SU1HF, MD5BL and MD5TS were also excellent contacts.

**Asia.**—The VUs, Js, etc., have been thinning out lately as conditions this last month have not apparently favoured north-south contacts. However, ZC6RG, VU7AB and CR9AG are three of the rarer ones worked.

**Oceania.**—The Northern Pacific area has shown some promise lately, and also the ZL have pounded through like locals. KH6JL, KH6DS, KH6BT, KH6AQ, KH6SP, W5LKW/KH6 and KM6AB were 100% contacts.

**14 Mc. Phone.**—This band has slackened off of late and conditions in general have been poor. However, the band provided some quite good QSOs and should show further improvement as the summer months approach, particularly at night time in the European direction.

**Europe.**—During the last week of the month the band has been open to this Continent from 1400 to 1700, 2300 to 0130, and also from 0630 to 0800 occasionally. Those worked late at night were OH5OA, G3BLG, G5OV, G2XC, OZ2IZ, OZ7TS. HB9FU, G3BM was worked during the afternoon and in the early morning period F8YW, F3SI, G2DS, G8QW, G2IG were all 100% QSOs.

**North America.**—Ws have been numerous and a few chaps are starting to come in via the long summer path across the South Pacific. VE3HI was the only Canadian worked. W9NTV was worked across South Africa at 0745 on the 24th, which shows that this Continent is starting to get into Australia from the south west.

**Central America.**—A few of these boys have put in an appearance on the high end of 14 Mc. CO2KO, CO2LA, TI2OA, VP9F, XE1FB, XE2KA, XE1QL and HR1MB were the rare ones.

**South America.**—Only one contact of note, that being HK1FQ who operates on 14395 or so nearly every evening of the week and just pounds through.

**Africa.**—One solitary contact was ZS5EW from Durban.

Asia.—Two nice QSOs—HZ1AB (Saudi, Arabia) worked at 0715, and ZC6JL (Palestine) worked immediately afterwards.

## TASMANIA

**Secretary: J. Brown, VK7BJ**  
12 Thirza Street, New Town.  
Phone W 1328.

**Meeting. Place: Photographic Society's Rooms, 163 Liverpool Street, Hobart.**

**Meeting Night: First Wednesday of each month.**

Old man winter has withdrawn his bony fingers once more; the orchards are in blossom, white sails are on the water and—what?—Radio? ah, yes. Well, there were thirty-one at the October meeting, all more or less comfortably disposed around the place, but it was nice to hear from 7EJ that negotiations are under way for some lebensraum up the road. More details of this should soon be available.

7XA made a further report on the Food-for-Britain Fund, which netted another £5/13/- on this occasion. The position now is that we have some food and the Gs can use it, but a letter from the R.S.G.B. indicates that we shall have to seek the British Food Ministry's permission to ship it in bulk. This is understood to be an anti-blackmarketing precaution and, as the only alternative is to break up the consignments into individual parcels with attendant expense, there may be some delay while the matter is being ironed out.

The idea of Morse practice transmissions was mooted and thought to be good, mainly for examination candidates whose speed is not well catered for. It is understood in all good feeling, however, that Peter Dunne considers there would be a danger of QRming the broadcast harmonics on 3.5 Mc. of a Sunday morning.

7LL, as reported earlier, represented us at a meeting of the Association of Scientific Societies. There is now some doubt as to whether any mutual benefit would result from our membership and it was decided to leave the matter in abeyance.

At the close of the meeting 7OM took the floor with a description of his adventures with a mangle, blocks and printer's ink in the course of turning out quite nice QSL cards. It is just like shelling peas. You don't really need a mangle, in fact you don't need anything but patience and an introduction from Bob to someone in the printing trade!

### PERSONALITIES

Eric Trebilcock, up at Wynyard, makes us feel like doing away with the rig, his SWL activities having brought in QSLs from close on a hundred countries this side of the war. — 7CW has trimmed up a radar receiver to do nicely for 50

Mc. — 7AF has his transmitter on paper and has rebuilt it a couple of times, but looks like making a big noise soon. — 7CT is building a new receiver between bouts of attending to Ford troubles. — 7KA is putting the theodolite over Tasman Peninsula, but cranks up the Type 3 Mark 2 occasionally.

7LJ putting out some nice phone, and has designs on the DX Contest. — 7BJ, 7YY and 7OM romping around on 3.5 Mc. one Sunday morning with Type A Mark 3s. — 7XA still firmly wedded to "Ten" (metres, Charlie, we trust) and doing nicely. — 7GH back on the air after many years, plans to keep an eye on the bands during a proposed spell in hospital. — 7JH also been on the casualty list after trying conclusions with a few thousand volts at Waddamana, but fortunately has little to show for it now. — 7GJ may soon be back among us, having nearly completed the new QTH.

### NORTHERN ZONE

The VK Phone Contest is being concluded as these notes are being compiled and as far as I can ascertain the Tasmanian effort this year was practically zero. Certainly no Amateur in the Launceston district participated. It is to be regretted that conditions for the first week-end were so bad. Possibly had conditions been better at the beginning, the Contest would have had better VK7 support.

Understand that several stations here will be operating during the c.w. portion of the test. Although none of our members here have any ideas about bringing home the major prize, we are hoping to keep Tasmania on the map.

Conditions for the month of September were very erratic with some excellent DX breaking in at odd times. 7BQ is still consistent on 7 Mc., although Len has done quite a lot of work on 50 Mc. lately. His 3 element certainly knocks my speaker about on this band. To date neither 7BQ or 7LZ have heard or worked anything—except each other.

7RK is still active on 14 Mc. and has been working some good DX on c.w. — 7DS is still on 7 Mc. and is going to stay there for the Contest. — 7GD is now building an all-band phone rig, using a pair of 809s. — 7TE, although Bill lives in Launceston, no one ever sees him. Understand he is confining his activities to 166 Mc. — 7AB and 7XL are now working regular skeds on 50 Mc. Doug is also building up some portable gear. — 7LZ just left these notes to QSO KG6AI. Gave him a number for the Contest and was informed that the contact made a difference of 500 points to his score. Just goes to show that some of us should have made the effort for the sake of the DX stations.

# A.G. HEALING

LIMITED

MANUFACTURERS AND  
DISTRIBUTORS FOR.....

Electrical and Testing Instruments for all purposes made to British Standard specifications. Each instrument is accurate, + or -, to 2 per cent., and parts are heavily plated to prevent corrosion even under tropical conditions. "Healing" Electrical Meters equal the best imported types and will give accurate service for long periods under the most exacting conditions.



No. 10A round production mounting Black Bakelite Case.

Type No. 30A 4" square semi-flush Black Bakelite Case.

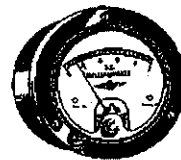
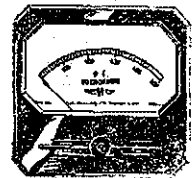

No. 20A 2½" round flush mounting Black Bakelite Case.

These, and all other Healing Radio Electrical Testing Units, are manufactured in our own factories and available from A. G. Healing Ltd.

OTHER INSTRUMENTS INCLUDE:

Oscillators — Multi-Testers — Signal Tracers, etc.

ALSO MANUFACTURERS AND DISTRIBUTORS FOR

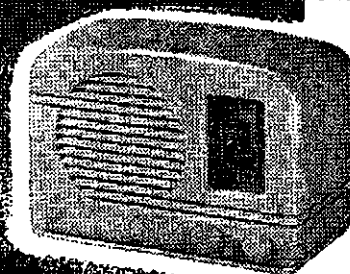

## Golden Voice RADIO

A. G. HEALING LTD., Melbourne, Sydney, Adelaide  
WESTERN AUSTRALIAN DISTRIBUTOR: Cloak's Household  
Utilities, 658 High Street, Perth. BRISBANE REPRESENTATIVE  
H. K. Lane, Basement, A.M.P. Building, Queen Street, Brisbane.  
TASMANIAN REPRESENTATIVE: C. J. Irvine, P.O. Box 375,  
Launceston.

# "TEN"

By VK5PS

So you are thinking of giving 28 Mc. a try-out young man? Well, I suppose you will learn more by actual experience than all the reading in the world, but I feel that a little information on the customs and mannerisms of the inhabitants of this band will not come amiss. Most of what is to follow is applicable to VK5 only, but probably applies equally well to any part of the world.

When first coming upon "Ten" after the rush and bustle of "Twenty" and "Forty" it is like turning up a side stream from off a swift flowing river after battling for many days with the strong current. It is decidedly quiet and peaceful with emphasis on the peaceful. The manner of speaking, the method with which the QSO is handled and the old world courtesy of the inhabitants has to be experienced to be appreciated.

Take the "modus operandi" of the answer to the CQ call. On "Twenty" one says "Hello VK5XYZ, this is VK5ABC right back." On "Ten" they say "VK5XYZ from VK5ABC." Just that and no more. A little chilling isn't it. It isn't meant that way, definitely not, it is just that this is the standard method of "Ten," and when you remember that some of these inhabitants have been cloistered on "Ten" for many years, never coming up for air, living and breathing the lavender and old lace atmosphere existing there, one can quite appreciate how the manners and customs have become so standardised. On "Ten" one says Q-R-ZEE, not Q-R-ZED, and when one signs on each over, it becomes almost a ritual, nearly as long as one of the "soap operas" heard on broadcast programmes (not that any true Ham would be guilty of listening to a broadcast programme).

One gives the street, the suburb, the district, the state and nearest capital city, the hemisphere and a couple of nearby constellations for good measure. If by any chance one should omit any of these very important particulars, the note of pain in the voice at the other end of the QSO is plainly discernable. There are none of those slap dash quick fire contacts on "Ten" such as we experience on "Twenty" or "Forty." No Sir! Most of the contacts start on Monday night and aside for time off for sleeping, eating and a little attendance at one's vocation, it goes on until the following Sunday night. What about DX you say. It's there for the asking and sometimes without asking, but the inhabitants are not very interested in DX on this band.

Familiarity breeds contempt I expect. The standard QSO usually opens with "Good evening old man and how is Mum" ("Mum" mind you, not the XYL), and usually contains a couple of references to "home made fig jam" or "thank you for the recipe on fairy sponge, 'Mum' (there it is again) quite enjoyed it."

This patter is tossed about by both sides, and eventually someone gets around to a signal report which apparently nobody is interested in because it is usually R5 S9 anyway. A little mild excitement now creeps in as both sides indulge in a bout of beam swinging, whizzing their beams around and discoursing on S meters, and back-to-front ratios, etc., until "Mum" (she's in again) brings in a cup of tea and a few biscuits, thereby breaking up this extremely technical discussion, and judging by the quick breathing of both sides of the QSO, it is just in time to save them both from collapsing from heart failure. It's a long way down to the bottom of the garden to swing that beam you know. It now becomes no secret that biscuits and tea are on the menu, because a noise like a stone crusher in action denotes biscuits and a something like the plug being pulled out of a bath must surely be tea drinking.

Now perhaps you have occasionally over-modulated on "Twenty" and when it was mentioned to you, you mentally advised the chap on the other end to jump in the lake, and went merrily on your way. On "Ten" this is handled with much more finesse. During the QSO, at a suitable time, the other end will gently say "I think old boy you could turn back your gain control slightly on the next over. I am receiving you real well here." Now I ask you, could you resist that? Should you possibly possess the hide of a rhinoc, no rhinos, well! an alligator and still over-modulate after this polite hint you will no doubt hear something resembling the following.

"I say old boy, I just heard those bounders Paseby and Parbier with their disposal transmitters over-modulating like the very deuce, somebody should speak to the cads about it." Could you still do your alligator act after hearing that sort of thing?

Now young man after awhile all this will so enter your bones that you will become just like the regular inhabitants, asking how "Mum" is (here's that woman again) and even falling for fairy sponge and fig jam, so much so, that in an attempt to shake free the shackles of "Ten" you will go back to "Twenty" for one QSO, yes one QSO only, and you will be so bewildered and flurried at all the rush and bustle that you will scurry back to the peace and quietness of "Ten," resolved never to

venture away again from such a haven of rest.

By the way young man have you ever tasted "Mum's" (this is where I came in) fairy sponge? Pardon me! I thought we were on "Ten"! Sorry to have kept you so long old boy—did dit dit dah dit dah.

## CORRESPONDENCE

Bega, N.S.W.

Editor, "A.R.,"

The letter in September "A.R." from Messrs. Harrison and Buck seems to reflect the attitude of those who passed the A.O.C.P. when telegraphy was more important than technical ability; when only a few of the very best stations had plate modulation and multi-stage transmitters.

It does seem to me that being a telegraphist is something entirely separate from, and in no way, indicative of one's technical capabilities. Telegraphists can be mass produced like sausages, and from similar materials. That keenness and intelligence, which can make an ideal amateur experimenter, are often turned to other channels by the compulsory period of boredom entailed in learning the code.

If, after having pushed oneself through this period, another six months of having to drag oneself through contacts with, mainly, other beginners has to be gone through, then one would be quite justified in keeping off code for life.

Except for a few limited applications, the day of hand telegraphic communication is fast going, and cutting out the probationary period is a step in the right direction, that is, towards deleting altogether the telegraphy part of the A.O.C.P.

The question is—telegraphists or technicians? Ham Radio is losing too many of the latter today.

Yours faithfully,

L. VALE, VK2ANN.

49 Farnham Road,  
Ashford, S.A.

Editor, "A.R.,"

The genuine Ham will agree most heartily with Messrs. Harrison and Buck. I feel sure that the Department realises the value of the Morse Code and it will continue to be a requirement.

One way in which we can justify our occupancy of the bands is our potential value to the armed forces. This value would drop immensely if we were all phone men. (The U.S.N. claimed that phone men had to start all over again.)

The W.I.A. can be the big factor in maintaining our prestige and efficiency and should make every

effort to do so. It would be an excellent idea if the greater part of the official W.I.A. broadcasts were made in Morse, without a repetition on phone.

Perhaps the Navy Minister could be persuaded to make an annual broadcast on Trafalgar Day, along the lines of the A.R.R.L. annual navy day broadcast.

Yours fraternally,  
J. COULTER.

## VALVES FOR F.M. RECEIVERS

After careful investigation of the whole position, A.W.V. Co. have decided to standardise on two types of miniature a.c. valves which are essential for the design and manufacture of f.m. receivers. The first is type 6BA6, a high-slope r.f. pentode which is suitable for use as an r.f. or i.f. amplifier. It has exceptionally low grid-plate capacitance and does not require an external shield. The second is type 6BE6, a miniature converter.

Data on types 6BA6 and 6BE6 are given below:—

### RADIOTRON 6BA6

#### Miniature R.F. Pentode

Radiotron 6BA6 is a miniature high-slope r.f. amplifier with remote cutoff.

#### GENERAL DATA

##### Electrical:—

Heater for unipotential cathode:

Voltage ..... 6.3 a.c. or d.c. volts  
Current ..... 0.3 amp.

Direct Interelectrode Capacitance:<sup>a</sup>

Grid No. 1 to  
plate ..... 0.0035 max. uufd.  
Input ..... 5.5 uufd.  
Output ..... 5.0 uufd.

##### Mechanical:

Mounting Position ..... Any  
Maximum Overall Length ..... 2 $\frac{1}{8}$ "  
Maximum Seated Length ..... 1 $\frac{3}{8}$ "  
Length from Base Seat to Bulb  
Top (excluding tip) .. 1 $\frac{1}{2}$ "  $\pm$  3/32"  
Maximum Diameter .....  $\frac{3}{8}$ "  
Bulb ..... T-5- $\frac{1}{2}$   
Base ..... Miniature Button 7-Pin  
Basing Designation ..... 7BK1  
Pin 1-Grid No. 1  
Pin 2-Grid No. 3, Internal Shield  
Pin 3-Heater  
Pin 4-Heater  
Pin 5-Plate  
Pin 6-Grid No. 2  
Pin 7-Cathode

### CLASS A<sub>1</sub> AMPLIFIER

Maximum Ratings, Design-Centre

Values:—  
Plate Voltage ..... 300 max. volts  
Grid No. 2 (screen) voltage ..... 125 max. volts  
Grid No. 2 supply voltage ..... 300 max. volts  
Plate dissipation ..... 3 max. watts  
Grid No. 2 dissipation ..... 0.6 max. watts  
Grid No. 1 (control grid) voltage:  
Neg. bias value ..... 50 max. volts  
Pos. bias value ..... 0 max. volts

Peak heater-Cathode voltage:

Heater neg. with respect to Cath. 90 max. volts  
Heater pos. with respect to cath. 90 max. volts

#### Typical Operation & Characteristics:

Plate voltage ..... 100 250 volts  
Grid No. 3 (suppressor) connected to cath. at socket  
Grid No. 2 voltage ..... 100 100 volts  
Cathode-bias resistor ..... 68 68 ohms  
Plate Resistance (approx.) ..... 0.25 1.5 meg.  
Transconductance ..... 4300 4400 umhos  
Grid No. 1 bias (approx.) for transconductance of 50 umhos ..... -20 -20 mA.  
Plate current ..... 10.8 11 mA.  
Grid No. 2 current ..... 4.4 4.2 mA.  
<sup>a</sup> With no external shield.

### RADIOTRON 6BE6

#### Miniature Pentagrid Converter

Radiotron type 6BE6 is a miniature converter having characteristics closely resembling those of type 6SA7GT.

#### GENERAL DATA

##### Electrical:—

Heater, for Unipotential Cathode:

Voltage ..... 6.3 a.c. or d.c. volts  
Current ..... 0.3 amp.

Direct Interelectrode Capacitance:<sup>a</sup>

Grid No. 3 to all other electrodes (r.f. input) ..... 7.2 uufd.  
Plate to all other electrodes (mixer output) ..... 8.6 uufd.  
Grid No. 1 to all other electrodes (osc. input) ..... 5.5 uufd.  
Grid No. 3 to plate ..... 0.30 max. uufd.  
Grid No. 1 to grid No. 3 ..... 0.15 max. uufd.  
Grid No. 1 to plate ..... 0.05 max. uufd.  
Grid No. 1 to all other electrodes except cathode .. 2.7 uufd.  
Grid No. 1 to cathode ..... 2.8 uufd.  
Cathode to all other electrodes except Grid No. 1 15 uufd.

##### Mechanical:—

Mounting Position ..... Any  
Maximum Overall Length ..... 2 $\frac{1}{8}$ "  
Maximum Seated Length ..... 1 $\frac{3}{8}$ "  
Length from Base Seat to Bulb  
Top (excluding tip) .. 1 $\frac{1}{2}$ "  $\pm$  3/32"  
Maximum Diameter .....  $\frac{3}{8}$ "  
Bulb ..... T-5- $\frac{1}{2}$   
Base ..... Miniature button 7-Pin  
Basing designation ..... 7CH  
Pin 1-Grid No. 1  
Pin 2-Cathode, Grid No. 5  
Pin 3-Heater  
Pin 4-Heater  
Pin 5-Plate  
Pin 6-Grid No. 2, Grid No. 4  
Pin 7-Grid No. 3

### CONVERTER

Maximum ratings, design-centre values:—

Plate voltage ..... 300 max. volts  
Grids-No. 2 and No. 4 voltage ..... 100 max. volts  
Grids-No. 2 and No. 4 supply voltage ..... 300 max. volts  
Plate dissipation ..... 1.0 max. watt  
Grids-No. 2 and No. 4 dissipation ..... 1.0 max. watt  
Total cathode current ..... 14 max. mA.  
Grid-No. 3 voltage:  
Neg. bias value ..... 50 max. volts  
Pos. bias value ..... 0 max. volts  
Peak heater-Cathode voltage:  
Heater neg. with respect to cath. ... 90 max. volts  
Heater pos. with respect to cath. ... 90 max. volts  
Characteristics—Separate excitation:<sup>a</sup>  
Plate voltage ..... 100 250 volts  
Grids-No. 2 and No. 4 (screen) voltage ..... 100 100 volts  
Grid-No. 3 (control grid) voltage ..... -1.5 -1.5 volts  
Grid-No. 1 (oscillator grid) resistor ..... 20000 20000<sup>a</sup> ohms  
Plate resistance (approx.) ..... 0.5 1.0 meg.  
Conversion transconductance ..... 455 475 umhos  
Conversion transconductance (approx.)<sup>†</sup> ..... 4 4 umhos  
Plate current ..... 2.8 3.0 mA.  
Grids-No. 2 and No. 4 current ..... 7.3 7.1 mA.  
Grid-No. 1 cur'nt ..... 0.5 0.5 mA.  
Total cath. cur'nt ..... 10.6 10.6 mA.

NOTE.—The transconductance between grid No. 1 and grids No. 2 and No. 4 connected to plate (not oscillating) is approximately 7250 micromhos under the following conditions: grids No. 1 and No. 3 at 0 volts; grids No. 2 and No. 4 and plate at 100 volts. Under same conditions, the plate current is 25 milliamperes, and the amplification factor is 20.

<sup>a</sup>The characteristics shown with separate excitation correspond very closely with those obtained in a self-excited oscillator circuit operating with zero bias.

<sup>†</sup>With grid-No. 3 bias of -30 volts.

<sup>a</sup>With no external shield.

—Extract from Radiotronics, No. 119.

## FOR SALE, EXCHANGE, WANTED

9d. per line, minimum 2/-

WANTED by Technical Advisory Committee, small quantity of Masonite Sheets, Hardwood Flooring and other Timber suitable for construction of Laboratory Test and Work Bench at the W.I.A. Rooms. For details as to quantity, please contact the Secretary T.A.C., Duncan Gray, VK3ADG.

**R**adio  
adio  
adio

For The  
Amateur Broadcaster

**RADIO PARTS** From  
**LAWRENCE & HANSON**  
ELECTRICAL PTY. LTD.

THE MOST SELECTIVE, MOST RELIABLE,  
MOST SATISFYING RANGE ANYWHERE!

We've said it before . . . it's worth repeating now—why look all over the city for your radio parts and components when you can get the BEST for your money with

LAWRENCE & HANSON  
RADIO PARTS

The high quality radio components from L. & H. are guaranteed always dependable . . . reliable and built to give long years of faithful service.

If you're re-fitting out your old transmitter or receiver or just adding something new and modern, look up the list of L. & H. Radio Parts.

Latest lists and prices are available from your radio house. When in doubt about what and where to get parts for your set, ask the chap next door or the fellow enthusiast down the street—he'll recommend Lawrence & Hanson Radio Parts—everytime!



- \* Microphones
- \* Batteries
- \* Switches
- \* Vibrators
- \* Chokes
- \* Condensers
- \* Coils
- \* Meters
- \* Valves
- \* Transformers
- \* Chasses
- \* Speakers

Technical Advice  
given on request.

**LAWRENCE & HANSON ELECTRICAL** Pty. Ltd.

33 York Street, Sydney.

120 Collins Street, Hobart.

87 Elizabeth Street, Brisbane.

172 William Street, Melbourne.

60 Waymouth Street, Adelaide.

20 Paterson Street, Launceston.



# Listen to this!

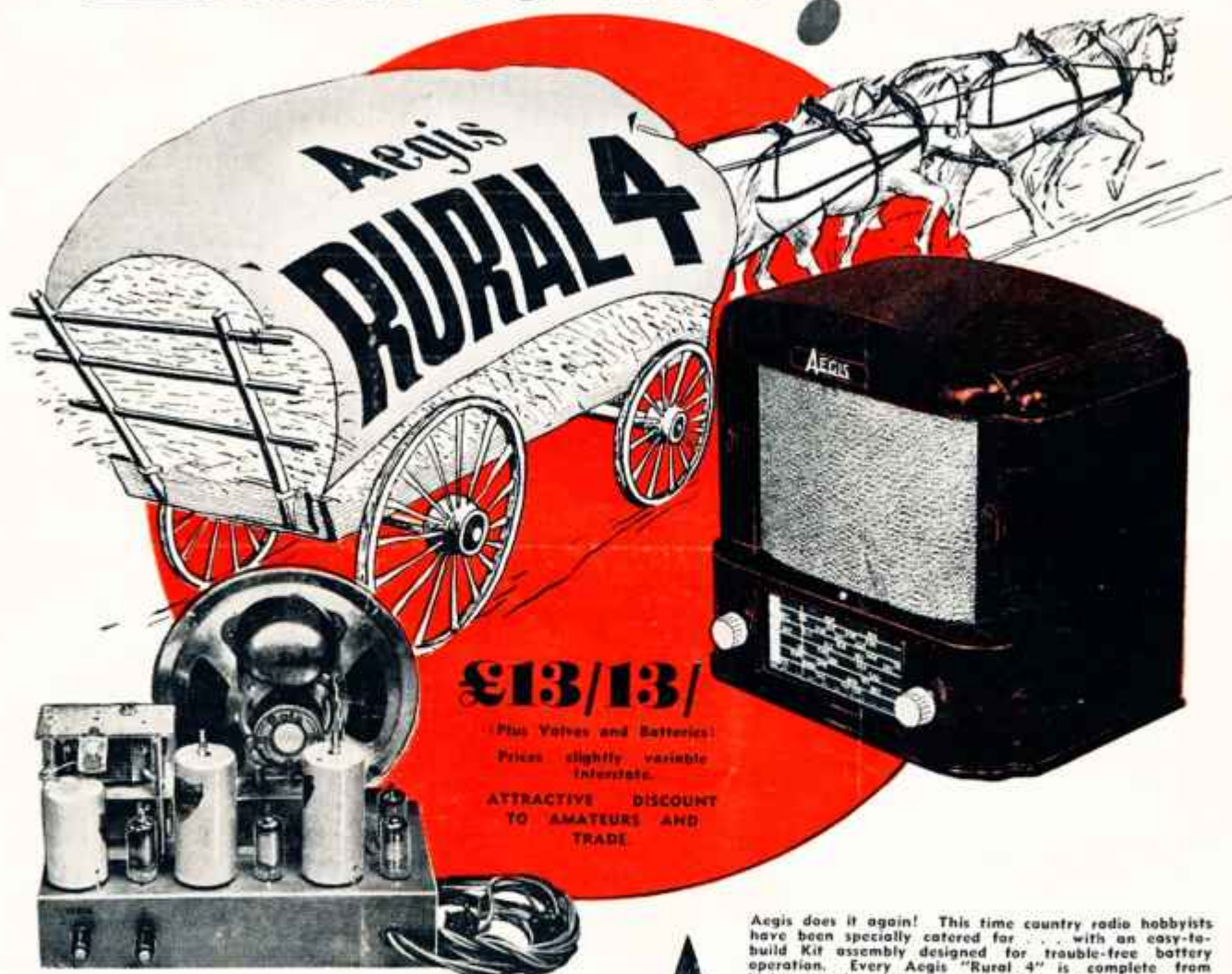

**£13/13/**

(Plus Valves and Batteries)  
Prices slightly variable  
Interstate.

ATTRACTIVE DISCOUNT  
TO AMATEURS AND  
TRADE

Aegis does it again! This time country radio hobbyists have been specially catered for... with an easy-to-build Kit assembly designed for trouble-free battery operation. Every Aegis "Rural 4" is complete from Valves to the last Nut and Bolt, together with full constructional details, all packed in sealed cartons with the "Aegis" symbol of satisfaction.

**Free** Write to your Distributor for 12 page fully illustrated Booklet of Circuits.

#### FEATURES OF THE "RURAL FOUR."

- Attractive mottled Bakelite cabinet.
- Button Valves for low drain with maximum gain—154, 1R5, 174, 354.
- "Aegis" Iron Core I.F.'s J9 and J10 specially designed for optimum gain.
- "Rola" 6 inch Permagan Anisotropic Speaker with Isocore Transformer—highly important for Battery Sets.
- Chassis and all metal brackets cadmium-plated.
- W.S.T. Switch Potentiometer.

#### DISTRIBUTORS IN ALL STATES:—

**VICTORIA :**  
Replacement Parts  
Pty. Ltd.  
J. H. McGrath  
& Co.  
Lawrence &  
Hansen Elec. Pty. Ltd.  
John Martin  
Radio & Elec.  
Pty. Ltd.

**N.S.W. :**  
Geo. Brown  
Pty. Ltd.  
John Martin  
Pty. Ltd.

**W.A. :**  
Nicholsons Ltd.  
Atkins (W.A.)  
Ltd.  
**QUEENSLAND :**  
Chandlers Pty. Ltd.

**S.A. :**  
Healing Ltd.  
Harris, Scarfe Ltd.  
Newton, McLaren  
Ltd.

**T.A.S. :**  
Lawrence &  
Hansen Elec. Pty.  
Ltd.  
Launceston and  
Hobart

# AEGIS

**MANUFACTURING COMPANY** PTY LTD

208 LT. LONSDALE ST., MELBOURNE

# AMATEUR RADIO

DECEMBER

1947

JOURNAL OF THE WIRELESS INSTITUTE OF AUSTRALIA

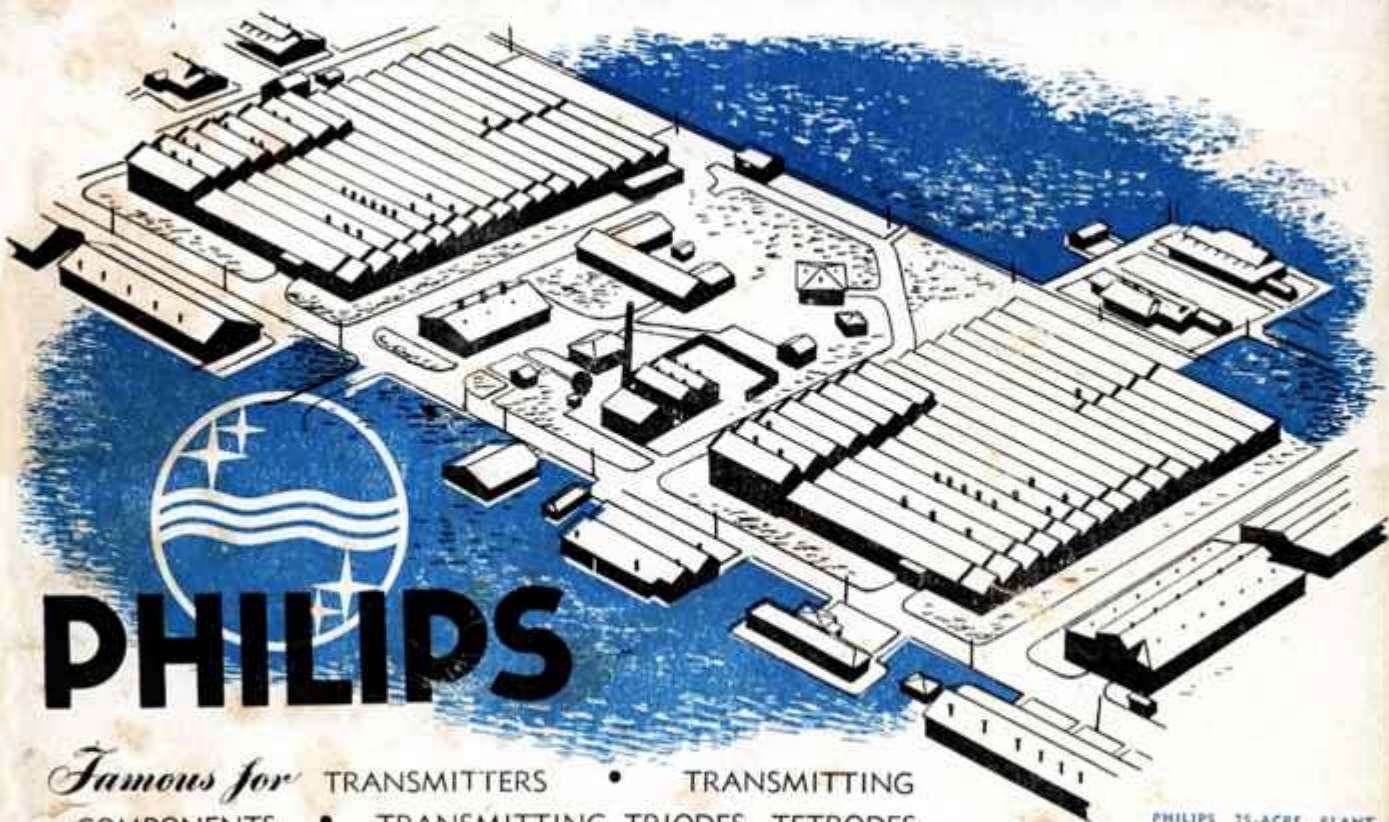

# PHILIPS

*Famous for* TRANSMITTERS • TRANSMITTING  
COMPONENTS • TRANSMITTING TRIODES, TETRODES  
AND PENTODES • HIGH VACUUM AND MERCURY  
VAPOUR RECTIFIERS.

PHILIPS 35-ACRE PLANT  
AT HENDON, SOUTH AUS-  
TRALIA. THREE PHILIPS  
FACTORIES ARE COM-  
BINED IN THIS MODERN  
PLANT.

PHILIPS ELECTRICAL INDUSTRIES OF AUSTRALIA PTY. LTD.

SYDNEY

MELBOURNE

ADELAIDE

PERTH

BRISBANE



FOR THE EXPERIMENTER & RADIO ENTHUSIAST

Registered at G.P.O., Melbourne, for transmission by post as a periodical.

6<sup>d.</sup>

# These Kingsley Products are making Radio History!



## KINGSLEY K/S9'er SIGNAL BOOSTER

Since its recent introduction the K/S9'er has met with widespread favour, many hundreds now being used throughout Australia. The K/S9'er does everything claimed for it, and is being acclaimed everywhere by satisfied users. It operates on 10 metres, and additional plug-in coil boxes to operate on the 6 and 20 metre bands are now available at little extra cost.

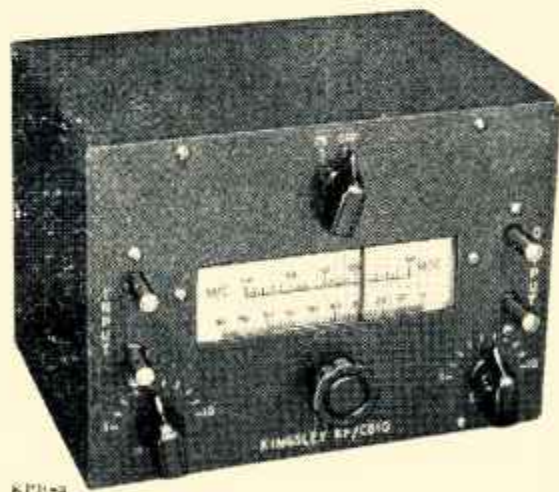

## KINGSLEY SHORT WAVE CONVERTOR

Ready for immediate use on 50/54 megacycles (6 metres) band, the KF/C6 is completely assembled, aligned, and adjusted. Early in the new year Kingsley will produce a unit designed for operation on 6, 10, and 20 metre bands achieved by a combination of iron slab tuning and plug-in coils, the principle of which was outlined in an article on page 23, November issue "Australasian Radio World."

*Complete installation and circuit details of both units are obtainable on application.*



# KINGSLEY RADIO

KINGSLEY RADIO PTY. LTD.

380 St. Kilda Road, Melbourne, Victoria . Phones: MX 1159, MX 3653

**Editor:**

T. D. HOGAN, VK3HX.  
Telephone: UM 1732.

**Technical Editor:**

J. K. RIDGWAY, VK3CR.

**Notes Editor:**

R. W. HIGGINBOTHAM, VK3RN.

**Distribution:**

H. N. STEVENS, VK3JO.

**Business Manager:**

J. G. MARSLAND, VK3NY.

**Advertising Representative:**

W. J. LEWIS,  
20 Queen Street, Melbourne, C.1.  
Telephone: MU 5154.

**Printers:**

H. HEARNE & CO. PTY. LTD.,  
285 Latrobe Street, Melbourne.

MSS. and Magazine Correspondence should be forwarded to the Editor, "Amateur Radio," Box 2611W, G.P.O., Melbourne, on or before the 15th of each month.

Subscription rate is 6/- per annum, in advance (post. paid).

— IN THIS ISSUE —

Modification of Type 3 Mark II Equipment .....	3
Frequency Modulation, Part II .....	6
Summary of Results at Atlantic City .....	9
Such Nice People .....	11
Federal Notes .....	12
Federal QSL Bureau .....	14
Correspondence .....	14
Fifty and Up .....	16
Divisional Notes .....	18
Amateur Call Signs, Alterations and Additions .....	27
Index to Volume 15 .....	28

# AMATEUR RADIO

*Published by The Wireless Institute of Australia,  
Law Court Chambers, 191 Queen Street,  
Melbourne, C.1*

## EDITORIAL



With the approach of the Christmas Season and the close of another year, every Amateur should pause to reflect, and recapitulate the events of the last twelve months before turning to the new horizons of the future.

We have seen many changes in Regulations, which have benefited the Amateur generally. The power limit has been increased to 100 watts, the waiving of several restrictive regulations such as the length of QSOs and the abolition of the probationary period on c.w. and for a finale, the recognition of the Amateur in International circles as a member of the Amateur Service, this latter a definite step forward in the status of the Amateur.

While we have not fared so well in some of the frequency allocations at Atlantic City, we have gained new bands to offset the losses sustained. We must bear in mind, in this matter of frequency allocations, the increasing need for Radio Navigational Aids which have gained at the expense of Amateurs and other fixed, mobile and Governmental Services. The Broadcast Services have also made gains in frequency allocations, the full implications of which we are not yet able to determine,

but is a subject which we will save for a more opportune time.

We have seen very rapid advances in techniques in the past year, and at this present time, have achieved through VK5KL the world's DX record for 50 Mc. With the availability of much surplus equipment from the various Services, an opportunity has come for many Amateurs to produce really efficient gear suitable for exploring the new bands and techniques made available to us.

Turning now to the future, we foresee a bright New Year for Amateur Radio in general, and the Wireless Institute in particular. We must work together in harmony, united in strength and with the knowledge that by so doing we can and will make the cause of the Amateur more widely respected and appreciated. In this way, we will make our presence felt Internationally with a larger voice at the next International Conference. NOW is the time to work towards that end.

To round off the year in the true spirit, the Federal Executive wish each and every Amateur A MERRY CHRISTMAS AND A HAPPY NEW YEAR.

W.T.S.M.

# Homecrafts The Radio Specialists

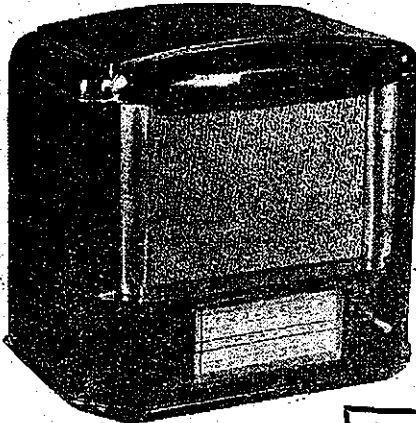

Bring you these SPECIAL XMAS BARGAINS

A BARGAIN FOR THE SET BUILDER !!

Foundation Kit, comprises assembled 5-valve steel Chassis and Dial, Bakelite Cabinet and Circuit Diagram. Xmas bargain price . . . . .

**50/-**

## HOME RECORDING OUTFITS

Including Traversing Gear, Electric Motor, Aluminium Turntable and Cutting Head.

**21 Gns.**

Recording Blanks 8", 10" and 12" available for immediate delivery.

## DISPOSALS VALVE BARGAINS !!

Available for Immediate Delivery.

EF50 High gain RF PENTODES . . . 17/3  
 EA50 Single DIODE suitable for vacuum tube voltmeters . . . 17/3  
 7A6 Twin DIODE . . . . . 17/3  
 807 Beam power AMPLIFIER . . . 16/6  
 42SPT 4v. Cossor screened PENTODE 14/-  
 VR122 Power Output PENTODE . . 14/-  
 7C7 Triple grid DETECTOR AMPLIFIER . . . 17/3  
 2x2 2.5 v. 4 pin HIGH VACUUM RECTIFIER . . . . . 16/6

All above prices include excise.



5BP1 5 inch CATHODE RAY TUBES.

Cost £15, now **37/6** plus Sales Tax.

Circuit blue print of Cathode Ray Oscillograph 1/6

2 bank 3 x 3 SWITCHES

**2/11**

Imported Bradley POTENTIOMETERS 10,000; 20,000 and 30,000 ohms.

**1/11**

2-stage DUAL WAVE UNITS incorporating IRON-CORE COILS

**35/-**

3 1/2 lb. Q Plus FOUNDATION KIT SET, including midget FERROPREG IF Transformer Q Plus loop and osc. coil chassis, cabinet, Hardware, hookup wire and complete instructions . . . . .

**£3/17/6**

Call and Inspect Homecraft huge range of Radio Equipm nt.

# HOME CRAFTS PTY. LTD. The Radio & Electrical Specialists

Head Office . . . . . MELBOURNE, 290 Lonsdale Street, and at—  
 211 Swanston Street, Melbourne. 307, Sturt Street, Ballarat. 139 Moorabool Street, Geelong. 121 Pirie Street, ADELAIDE.  
 100 Clarence Street, SYDNEY. 26 Hunter Street, Newcastle. Hobart, Lounceston and Burnie, TASMANIA.

# Modification of Type 3, Mark II Equipment

Collated by the Technical Advisory Committee (Vic. Division)

In response to numerous requests for publication in "Amateur Radio" of information regarding the use of Service type equipment for Amateur purposes, the T.A.C. conducted an extensive search for knowledge, and the ideas submitted hereunder are the results thereof. If the matter presented and the method of presentation meets with the approval of our readers, the T.A.C. will apply its energies to other Service equipment in a like manner.

## INSTALLATION OF 807 IN PLACE OF 6L6

By J. E. ROGERS<sup>2</sup>, VK3TO

The writer had been playing with the idea of replacing the 6L6 valve in the above transmitter with an 807 for some time, but the general opinion of those with whom the matter was discussed was that it would not fit in the case.

A.W.V. Company tables were consulted and it was found that the maximum length of type 807 including pins is 5 $\frac{1}{2}$ ". We therefore have  $\frac{3}{4}$ " to spare in the case which is 6 $\frac{1}{4}$ " high inside.

It is necessary to carefully space the socket from the chassis so that approximately 3/16" clearance is available at each end of the valve. The present hole in the chassis is just large enough to allow this to be done.

At this stage it should be noted that use of the right type of socket is essential; see Fig. 1 (1). The contacts grip the pins from the side and extend radially with the result that the length of the tube is not increased by the socket. The type of socket required was used in some Service equipment and odd samples have been seen on Disposals counters.

The following changes in placement of components and in wiring were found desirable:—

(a) The plate r.f. choke was moved up higher to shorten the plate lead.

(b) The screen supply was disconnected and the screen supplied from the high voltage through a 30,000 ohm 2 watt resistor in order to allow plate and screen modulation.

(c) The grid leak was changed from 20,000 ohms to 10,000 ohms to comply with the Valve Company's recommendations.

(d) A cylindrical metal shield was installed to screen the lower part of the tube; Fig. 1 (2).

(e) A parasitic suppressor (40 ohms) was placed right at the plate clip of the 807. (This may or may not be necessary.) Fig. 1 (3).

(f) The neutralising condenser was removed and replaced by a home-made item consisting of a 1" length of coaxial cable from which the centre wire was removed.

The outer screen is soldered to the grid side of the neutralising circuit and a  $\frac{3}{8}$ " machine screw, to which the plate lead is attached, is screwed in the hole in the centre of the insulation. Adjustment is made by turning the screw in or out of the hole as required. **Note.**—Use an insulated screwdriver. It will be found that this small capacity is sufficient for complete neutralisation.

The question will be asked "Why neutralise an 807?" The writer has always found 807s more easily tamed if neutralised and in the case of the Type 3 Mark II the circuit is already there, so why not?

When the above modification is completed two milliamps grid current can be obtained on 14 Mc. using a good 3.5 Mc. crystal.

It is not claimed that the modification produces revolutionary increases in output or efficiency, but 807 valves can be more easily and cheaply replaced than can type 6L6, added to which the owner feels happier modulating 30 watts input to a valve with plenty of reserve.

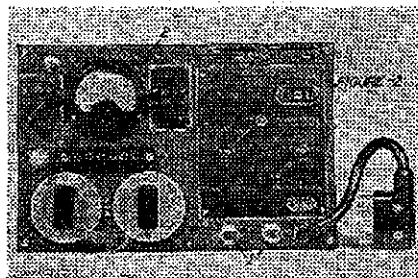

**WARNING**—Do not be tempted to load up the transmitter to high output just because 807 valves are cheap and can take it. Follow the instructions issued with the set and be safe. Replacement selenium rectifiers are hard to get and cost half as much as you paid for the complete outfit.

Additional modifications will be noticed in the illustration which, while they are not brought about by installation of the 807, may be of interest to some readers, i.e. two toggle switches will be seen on the front panel; Fig. 2 (1). They are used to short the key jacks for telephony and to short the modulation transformer for telegraphy. The modulator plugs in to the pin-jacks near the meter; Fig. 2 (2).

The two 12 mfd. electrolytic condensers in the rear view between the meter and the variable condensers are in series across the high voltage to provide additional smoothing for telephony. They are each shunted by a 100,000 ohm resistor to ensure even distribution of the voltage across each; Fig. 1 (4).

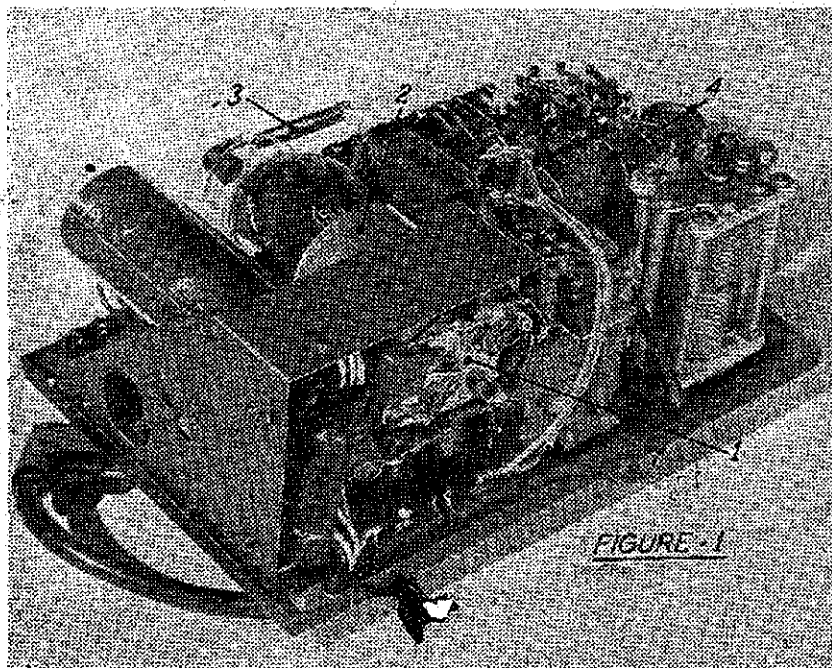

<sup>2</sup> 3 Moorhouse St., Camberwell, Vic.

additional capacitor connected between moving arm and point from whence C6c was removed. In other words, the d.c. grid connections of output valve are undisturbed. Thus we have an audio gain control in addition to normally provided i.f./mixer control.

### HOW TO USE A LOUD SPEAKER

By HERB STEVENS\*, VK3JO

The receiver as it stands is quite capable of operating a small "permag" speaker without additional amplification. The easiest way to use a speaker is to employ 600 ohm transformer to couple the voice coil to phone jacks of receiver; however where matching transformer is not available the following modifications will enable use of speaker with normal 10,000 to 15,000 ohm primary.

Drill hole beneath existing "phone" pin jacks and insert insulated jack therein. Connect 0.1 mfd. capacitor between this jack and the anode of output valve. Now, by inserting one lead from speaker into this jack and the other into earthed phone jack, "Bob's your uncle."

The spacing of jack should be so arranged that distance does not coincide with distance separating existing pin jacks in order to preclude possibility of mis-connecting phones.

### MODIFYING THE CARRYING CASES

By R. JEPSON, VK3JI

By judiciously applying hammer and chisel, external fittings may be removed. Now by fitting case handles to the top and rubber buffers to the base, we have a pair of units which can be mounted close together, or carried with ease. The writer discovered that the application of rubber feet relieved the tension on the aural organs occasioned by XYL's strenuous objections to having polished furniture carved by the rough surface of the units.

### REMOTE CONTROL

By CHAS QUINN\*, VK3WQ

The writer uses the Type 3 Transmitter in conjunction with external modulator unit and separate receiver. In order to effect switching from operating position the following modifications were adopted.

(1) Installation of telephone type key switch having four sets of change over contacts which operate as follows:—

Central position of key switch:—

(OFF) all circuits open.

Down position of key switch:—

(C.W.) First set of contacts apply 250 v. to transmitter for c.o. (existing "250 volt in" lead connected to lead going to key switch, other switch lead being

(Continued on Page 28)

# Part Two—FREQUENCY MODULATION— PRINCIPLES AND EQUIPMENT FUNDAMENTALS

By A. H. KAYE\*, B.Sc. (Melb.), A.M.I.E. (Aust.)

In concluding this article, the basis of which formed a lecture delivered to the Victorian Division, I now propose to deal briefly with equipment used, in particular to features which are peculiar to frequency modulation.

### MEANS OF FREQUENCY MODULATING THE CARRIER

The frequency generated by most valve oscillators is determined mainly by the inductance and capacity in the tuning arrangement, and the most obvious method of accomplishing frequency modulation is to cause the modulating frequencies to vary a reactance, i.e. either an inductance or capacity in the tuned circuit. Figure 9 shows in principle such an arrangement, and consists of an oscillating circuit with a condenser microphone in parallel with the capacity of the tuned circuit. Variations in the capacity of the condenser microphone will thereby vary the frequency of the oscillations generated, giving a frequency modulated output.

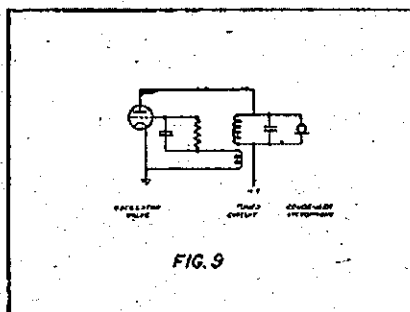

FIG. 9

The above arrangement is only crude, and in general a reactance valve is used across the tuned circuit rather than a microphone direct. The output circuit of this reactance valve is shunted across the tuned circuit of the oscillator, and its control grid excited by a voltage derived from the oscillator circuit but 90° out of phase with it. This grid voltage acts in the reactance tube plate circuit to draw an alternating current 90° out of phase with the oscillator tuned circuit voltage, and the tube thus acts as a shunting reactance. The reactance tube control grid is also driven by the modulating voltage, which can be regarded as a varying bias and therefore the plate current

varies in accordance with modulation, and likewise the shunting effect and the oscillator frequency. This arrangement is indicated in Figure 10.

It will be noted that this system is inherently unstable, and it is necessary in practice to introduce automatic frequency control, so that any carrier frequency drift is corrected by reference to a crystal oscillator.

Another system of modulation which has the advantage that the carrier is directly crystal controlled involves phase modulation. As mentioned earlier, frequency modulation is the same as phase modulation in which the amplitude of the modulating frequencies is inversely proportional to those modulating frequencies. In this system a predistorting

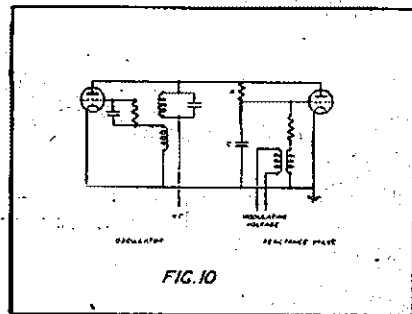

FIG. 10

network is used to give this inverse characteristic to the modulating frequencies, which then phase modulate a crystal controlled carrier.

Operation of this type of modulator is difficult to understand without mathematical analysis. Briefly, if we take the side band products only of an amplitude modulated carrier and add to these the carrier with a phase shift of 90°, then the resultant is a phase modulated carrier; amplitude modulation is also present and can be removed by a limiter. Figure 11 shows in simplified form this method—the output from the balanced modulator furnishes the side bands only, and these are added to the carrier with the necessary 90° phase shift.

I have mentioned only briefly these methods of modulation, and there are

\* 33 Auburn Grove, Hawthorn East, E.3.

\* 111. Edgevale Road, Hawthorn, E.4.

\* Divisional Engineer (Radio Station Construction), P.M.G.'s. Department, Central Administration.

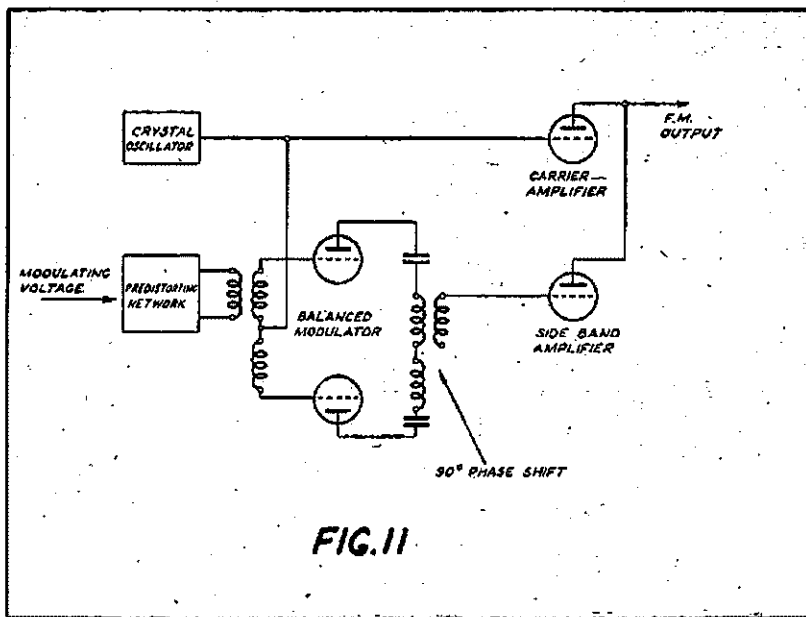

FIG. 11

many other methods and modifications, some involving optical systems and mechanical systems; a method of particular interest involves a new tube known as a phasitron, in which modulation is applied to an electron beam within the tube.

#### FREQUENCY MULTIPLICATION

Frequencies at which f.m. services operate involve the use of frequency multiplication of the crystal frequency, and this is done by use of valve multipliers. If an f.m. carrier is passed through such a multiplying chain, the carrier frequency and the deviation are multiplied accordingly, and the total band width occupied is increased.

Another method of increasing frequency (or similarly decreasing frequency if required) is by heterodyning the carrier with an oscillator of another frequency, and in this case the carrier changes to the difference between the original frequency and the heterodyning frequency; the frequency deviation and the band width are unchanged.

Both these systems of frequency changing are used, and the combination of the two in a single transmission system enables a suitable choice to be made of crystal frequency and initial frequency deviation, while giving the desired final carrier frequency and deviation. This is an important factor in respect to the phase shift modulation system, as it is necessary to keep the maximum phase deviation to a low value to ensure low distortion.

#### DEMODULATION

At the other end of the transmission system there must be a means of demodulating the frequency modulated carrier, and this is done in two parts, the first part of the equipment being the discriminator and the

second a detector, which is in general similar to the detector used in the amplitude modulation system. Basically, all that is required of the discriminator is that the amplitude of its output should vary according to the frequency of its input, and this can be achieved using a simple tuned circuit, the resonant frequency of which is slightly higher or lower than the frequency corresponding to maximum frequency deviation of the incoming carrier; frequency excursions up and down one side of the resonance curve with modulation give corresponding amplitude variations in the voltage across the tuned circuit. The input-output characteristic of such an arrangement is not linear so this simple tuned circuit is not used in practice.

Figure 12 shows a simple practical

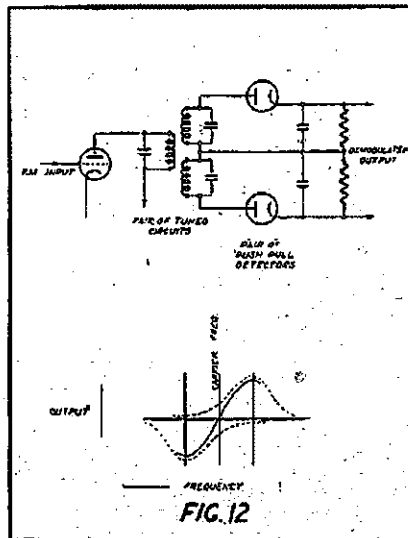

FIG. 12

discriminator known as the double tuned circuit or push-pull discriminator. This arrangement in the figure includes the rectifying or detecting elements and has one circuit which is resonant above the carrier frequency and the other just below. Each such tuned circuit works into a diode rectifier and the outputs are connected in opposition so that at carrier frequency the two outputs cancel out, whereas for other frequencies the output of one or other of the diodes predominates giving amplitude variations in the combin-

## CHASSIS — RACKS — PANELS

Any size, any gauge. Write enclosing full particulars. Quotation forwarded by return mail.

## METER SCALES

Suitable for Pullin "Disposal" meters. Volt-M.A.-Ohm or special Multi-meter scale.

Either type, 2/-, post free.

## POWER TRANSFORMERS

Wound on extra large core. Any voltage or amperage—Reasonably priced. 7-DAY DELIVERY SERVICE

Multi-Match modulation Transformers, 75-watt. In die-cast metal clamps, Write for full details.

£4/19/6. DELIVERY EX STOCK.

0—5 Amp. Thermo Ammeters, 17/6

VK3NU

# Major Radio & Electrical Co.

189 GLENFERRIE ROAD, MALVERN

WM 1814

U 9354



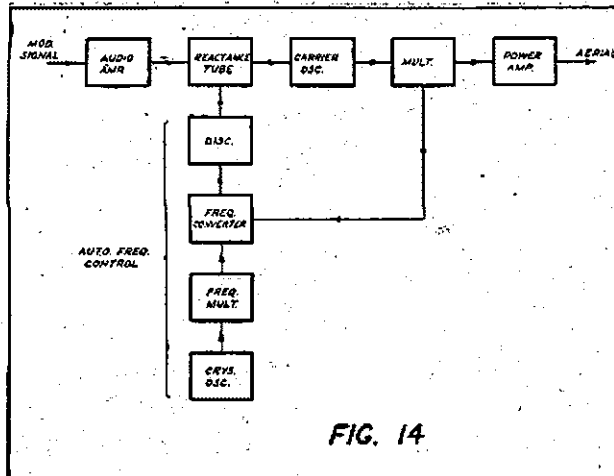
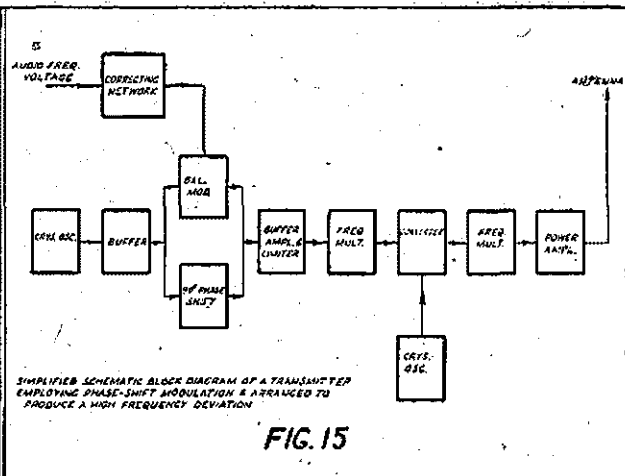

FIG. 14



SIMPLIFIED SCHEMATIC BLOCK DIAGRAM OF A TRANSMITTER EMPLOYING PHASE-SHIFT MODULATION & ARRANGED TO PRODUCE A HIGH FREQUENCY DEVIATION

FIG. 15

ing circuit directly proportional to frequency variations in the input.

There are many variations and modifications of the discriminator circuit, one simple though rather crude method being to detune an ordinary a.m. receiver, so that the side of the selectivity curve is set to the frequency of the incoming carrier; frequency excursions thus move up and down the selectivity curve giving corresponding amplitude variations in the output.

### LIMITER

Limiters are used in many other arrangements, but owing to the importance of this unit in the frequency modulation transmission system a few brief comments are justified. There are two main reasons for the use of this item, firstly to eliminate amplitude modulation noise, which was discussed above, and secondly to ensure that no amplitude modulation reaches the discriminator, which gives a distorted output under such conditions.

There are many types of limiter in use, but the essential feature is that a comparatively small signal causes overloading or saturation and prevents further increase in the amplitude of the output.

The limiter is preferably used immediately prior to the discriminator in order to minimise risk of distortion due to amplitude modulation, which could be caused by restriction of the band width. Therefore, the output of the limiter must be high enough to operate the discriminator and the gain of earlier stages must be great enough to saturate the limiting stage. It is perhaps relevant to comment here that the wide band required for f.m. (or at least in most f.m. applications) means a relatively low gain per stage.

It is also perhaps relevant to point out that because the limiter is used automatic volume control is not necessary to maintain a constant audio output from the receiver; it is fre-

quently desirable, however, to incorporate a.v.c. in the receiver to prevent overloading of the first detector, which would result in the production of spurious frequencies and give distortion and/or interference.

### PRE-EMPHASIS AND DE-EMPHASIS

It was pointed out above in connection with the f.m. noise triangle that there is a progressive increase in the amplitude at which noise is reproduced as we proceed from low to high audio frequencies. The depth of modulation is also normally low at the higher frequencies, which are required for high fidelity broadcasting.

Pre-emphasis is the system of increasing the level of the higher audio frequencies to give a depth of modulation approaching 100%, i.e. approaching maximum deviation, but it is necessary to avoid going right to 100% as this may result in over-modulation under some conditions. De-emphasis in the receiver is to restore the relative levels of the low and high audio frequencies, and the de-emphasis circuit must be complementary to the pre-emphasis circuit in the transmitter. For this reason it is essential in the case of broadcasting that a standard system of pre-emphasis and de-emphasis be used for all transmitters and receivers respectively. The pre-emphasis and de-

emphasis circuits can be regarded as complementary equalisers; the pre-emphasis circuit in the transmitter raises the level of the higher audio frequencies relative to the lower audio frequencies, while the de-emphasis circuit attenuates high frequency components with the result that the programme material is returned to its original form, and the interference due to high frequency noise is substantially reduced.

It should be noted that this arrangement could be applied to amplitude modulation, since the higher audio frequencies are usually at relatively low levels, but since the noise amplitude out of the receiver is in general constant and does not follow the triangle law of f.m., the improvement in this case is less.

In Figure 13 I have shown the gain in respect to noise level when the Pre-emphasis and De-emphasis system is applied to f.m. with various audio band widths. The circuits used in this case are the American Radio Manufacturers Association tentative standards. It might be noted that there is some loss due to the necessity for reducing the general depth of modulation so that over-modulation on peaks may be avoided; this is particularly important when instruments such as the guitar or piano are being broadcast. When the audio band width is less than about 3 Kc., there is very little gain from the system, while in narrow band systems there will actually be a loss.

To summarise the various items of equipment just discussed, I have shown in Figures 14 and 15 block schematics of complete transmitters, Figure 14 being typical of the arrangement in the transmitter using the reactance tube modulator, and Figure 15 being typical of the arrangement in a transmitter using the phase modulator. Particular attention is directed to the means of securing frequency stability in each of the two cases.

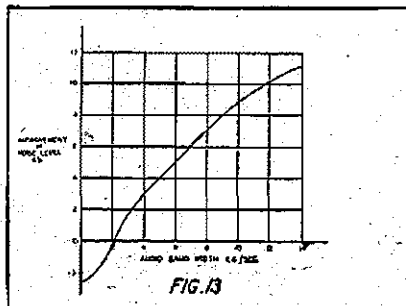

FIG. 13

# SUMMARY OF RESULTS AT ATLANTIC CITY

The following is a copy of a special issue of the I.A.R.U. Calendar reporting the actions of the International Radio Conference at Atlantic City, just concluded, insofar as they affect Amateur Radio.

I am obliged to say that Amateur Radio throughout the world will suffer some losses in frequency allocations as a result of this conference. I am happy to say, on the other hand, that we have some new frequency bands. These matters will be detailed hereinafter.

Previous Calendars have reported to you the advance planning of I.A.R.U. for this conference, the initial amateur proposals of various countries, and related matters. Actually, previous Calendars constitute a part of the overall story, as do also my "Atlantic City Reports," which have been appearing in QST throughout the summer months. In the present Calendar I shall limit myself principally to a summary of results.

## NEW DEFINITIONS

First, you will be interested in some general matters. Article 1 of the Radio Regulations contains the following definitions:—

**Amateur Service.**—A service of self-training, intercommunication and technical investigations carried on by amateurs, that is, by duly authorized persons interested in radio techniques solely with a personal aim and without pecuniary interest.

**Amateur Station.**—A station in the amateur service.

We believe these new definitions represent a positive step forward. For the first time we are definitely recognised as one of the world's radio services. Previously amateurs have been established as a separate class, solely on the basis of our personal and non-pecuniary interest. The new definition retains this fundamental aspect but is expanded to show that amateurs engage in self-training and technical investigations, advancing us well beyond the "hobby" or pastime stage, and establishing our activities as a constructive, contributing service.

Article 42 of the Radio Regulations is entitled "Amateur Stations." It reads as follows:—

§1. Radio communications between amateur stations of different countries shall be forbidden if the administration of one of the countries concerned has notified that it objects to such radio communications.

§2. (1) When transmissions between amateur stations of different countries are permitted they must be made in plain language and must be limited to messages of a technical nature relating to tests and to remarks of a personal character for which, by reason of their unimportance, recourse to the public telecommunications service is not justified. It is absolutely forbidden for amateur stations to be used for transmitting

international communications on behalf of third parties.

(2) The preceding provisions may be modified by special arrangements between the countries concerned.

§3. (1) Any person operating the apparatus in an amateur station must have proved that he is able to transmit, and to receive by ear, texts in Morse Code signals. Administrations concerned may, however, waive this requirement in the case of stations making use exclusively of frequencies above 1,000 (one thousand) Mc.

(2) Administrations shall take such measures as they judge necessary to verify the qualifications, from a technical point of view, of any person operating the apparatus of an amateur station.

§4. The maximum power of amateur stations shall be fixed by the administrations concerned, having regard to the technical qualifications of the operators and to the conditions under which these stations must work.

§5. (1) All the general rules of the Convention and of the present Regulations shall apply to amateur stations. In particular, the transmitting frequency must be as constant and as free from harmonics as the state of technical development for stations of this nature permits.

(2) During the course of their transmissions amateur stations must transmit their call sign at short intervals.

For the first time, the line of distinction between amateur stations and private experimental stations is now complete. While the two services were originally covered by the same regulations, in Madrid (1932) the definitions applying to amateurs were first set up separately from the experimental services, and now this article pertaining to general regulations is devoted exclusively to us. With one exception its provisions are of identical effect to those of Cairo. The exception is that the requirement of code ability as a prerequisite to operating authorisation may be waived, at the discretion of individual administrations, in case of amateur stations making use exclusively of frequencies above 1,000 Mc.

## FREQUENCY ALLOCATION

We come now to the matter of frequency allocations. As always, this was the major conference subject. It is impossible to describe herein the many developments which produced the final table. I can only refer you again to the QST series of "Atlantic City Reports."

It was possible to solve some of the frequency allocation problems resulting from divergent viewpoints of the

interested nations by resorting to regional allocations, principally in those portions of the spectrum between approximately 5 and 27 Mc. where radio signals have, for the most part, small international effect. The world was divided into three regions. Region 1 consists principally of Europe and Africa, plus all the remaining territory of the U.S.S.R. in Asia, and plus Outer Mongolia. Region 2 consists of the Americas, including the Caribbean area and Greenland, plus the Hawaiian Islands. Region 3 is the rest of the world, consisting mainly of Asia (minus U.S.S.R. and Outer Mongolia), Australia, New Zealand, and Oceania generally.

To give you a clearer understanding as you read the material to follow, I list below, by regions, the location of countries represented in I.A.R.U.—

**Region 1.**—Austria, Belgium, Czechoslovakia, Denmark, Finland, France, Great Britain, Ireland, Italy, Luxemburg, Netherlands, Norway, Portugal, South Africa, Sweden and Switzerland.

**Region 2.**—Argentina, Brazil, Canada, Chile, Colombia, Cuba, Mexico, Newfoundland, Paraguay, United States, Uruguay and Venezuela.

**Region 3.**—Australia, China, Netherlands Indies and New Zealand.

## AS TO 1.715 Mc.

In Region 1 (Europe-Africa) the amateur service has been deleted from the allocation table as one of the users of this band. However, a footnote provides that Austria, Ireland, Netherlands, Northern and Southern Rhodesia, Switzerland, South Africa and the U.K. may assign to the amateur service up to 200 Kc. of the band 1715-2000 Kc., with a mean power limit of ten watts and on condition of no harmful interference to other services.

In Region 2 and 3 the allocation of 1800-2000 Kc. is to (a) amateur, (b) fixed, (c) mobile, except aeronautical mobile, and (d) radio navigation. A footnote establishes a priority for two loran channels 1800-1900 and 1900-2000 Kc., but provides that any of the other services (a, b, c above) may employ whichever of these two channels is not required for loran, on condition of no harmful interference to loran. However, in the northern part of Region 2 this provision offers no tangible frequencies for amateurs at present, inasmuch as in this area both channels are currently used for the loran navigational service. It should be here recorded that this entire matter will probably be reviewed and possibly revised at a special conference on loran some time in 1949.

## AS TO 3.5 Mc.

In Region 1 there is a reduction of 100 Kc. in the frequencies available in our 80-metre band. The band 3500-3800 Kc. is allocated to (a) amateur, (b) fixed, (c) mobile, ex-

cept aeronautical mobile. Aeronautical mobile gains the 3800-3900 Kc. band (shared with fixed and land mobile) as well as 3900-3950 Kc. Although the band 3500-3800 Kc. may be assigned exclusively to amateurs, it is our understanding that in most cases amateurs will operate in those 300 Kc. on a mixed-shared basis with the other two services.

In Region 2 the allocation is almost precisely the same as at Cairo, the Atlantic City table showing 3500-4000 Kc. assigned to (a) amateur, (b) fixed, and (c) mobile, except aeronautical mobile. The maintenance of this band as exclusively amateur will be a subject for the Inter-American Radio Conference scheduled for Bogota, Colombia, in October of 1948.

In Region 3 the allocation is identical to Cairo except that the band is reduced to 3500-3900 Kc. In this area there is the possibility of regional or sub-regional agreements on this band.

#### AS TO 7-Mc.

As expected from the initial proposals of many countries, principally European, discussion of the frequencies in our 40-metre band resulted in a protracted battle between broadcasting and amateurs. The final allocation was made on a regional basis and is not encouraging, not only because amateurs in countries outside the Americas will suffer the loss of a large part of this band, but also because amateurs in the American

region will undoubtedly experience a great deal of interference from the operation of broadcast stations.

In Region 1 7000-7100 Kc. is assigned exclusively to amateurs. The band 7100-7150 is shared between amateurs and broadcasting, use by the amateur service being authorised on condition of no harmful interference to broadcasting. Broadcasting obtains exclusive rights to the remainder of the band, 7150-7300 Kc. In the Union of South Africa and the territory under mandate of South-West Africa, however, 7100-7150 Kc. will be used exclusively for the amateur service.

In Region 2 the entire band 7000-7300 is allocated exclusively to the amateur service.

In Region 3 the allocation is identical to that in Europe-Africa: 7000-7100 exclusively amateur, 7100-7150 shared between amateurs and broadcasting; 7150-7300 exclusively broadcasting. China and New Zealand, however, have indicated a desire to assign 7100-7300 Kc. to the amateur service. The conference has insisted, nevertheless, that these countries, as well as Australia and Netherlands East Indies insofar as amateur operation in 7100-7150 Kc. is concerned, must "take all practicable steps to avoid causing any harmful interference to the broadcasting service and ensure that amateur stations do not use a peak power exceeding 100 watts. If, however, harmful interference to the broadcasting service is

experienced, these administrations will consider reducing the use of these bands by the amateur service."

#### AS TO 14 Mc.

The Atlantic City conference has reduced our 20-metre band by 50 Kc. The allocation table provides an exclusively amateur band 14000-14350 Kc. The remainder will go to the fixed service on the effective date of the new regulations. In addition, U.S.S.R. will use 14250-14350 Kc. for the fixed service within its own boundaries, and has pledged itself to use technical means to hold possible interference to amateurs to a minimum.

#### AS TO 21 Mc.

I am pleased to report that amateurs will have a new, exclusive, world-wide band 21000-21450 Kc.

#### AS TO 27 Mc.

A new frequency (27,120 Kc.) was set up at Atlantic City for "industrial, scientific and medical purposes," such emissions to be confined within  $\pm 0.6\%$  of that frequency. In a 270 Kc. portion of this "I.S.M." band (26960-27230 Kc.), authorisation for amateur shared use will be issued by the countries of Region 2 and by Australia, New Zealand, Union of South Africa, and the territory under mandate of South-West Africa.

#### AS TO 28 Mc.

Our 10-metre band will become 28000-29700 Kc., one of the factors in the reduction of the band limits being the establishment of the 27 Mc. band detailed above. However, our

**"ALL-ROUND" EFFICIENCY**

**TRIMAX TRANSFORMERS**

Available in Line to Line, Line to Grid, Plate to Line, Interstage—Single and Push-Pull Types—Trimax Transformers are constructed of the finest materials and feature high Permeability, Nickel Iron Alloy core—heat treated in our own factory for Optimum results.

Also for Amplifier enthusiasts . . . Standard or Custom built Chassis, Speaker Flores, Microphone Stands, Power Transformers, Filter Chokes, etc.

**TRIMAX TRANSFORMERS**  
(Division of Cliff & Bunting Pty. Ltd.)

**29-35 FLEMINGTON RD., NORTH MELBOURNE**

Interstate  
Representatives:

N.S.W.:  
L. B. Graham,  
5 North York St.,  
SYDNEY

QUEENSLAND:  
Chandlers Pty. Ltd.,  
Cnr. Albert and  
Charlotte Sts.,  
BRISBANE

S.A.:  
C. N. Muller  
Worando Buildings,  
Grenfell Street,  
ADELAIDE

W.A.:  
R. D. Benjamin,  
197 Murray Street,  
PERTH

TASMANIA:  
W. & G. Genders  
Pty. Ltd.,  
53 Cameron Street,  
LAUNCESTON

ENQUIRE FROM YOUR NEAREST SUPPLIER

28 Mc. band will be exclusively an amateur assignment throughout the world, the Cairo allocation to "experimental" stations now being deleted.

#### AS TO 50 Mc.

In Region 1, I am obliged to report there is no general amateur allocation between 29.7 and 144 Mc. However, South Africa, South-West Africa and the Rhodesias will assign 50-54 Mc. exclusively to the amateur service. In France and U.S.S.R., 72-72.8 Mc. will be assigned to amateurs.

Except as noted above for certain African areas, Region 1 has adopted 41-68 Mc. for broadcasting, with the intention of using it only for television. It is much larger than television will need for years to come. Each country retaining freedom to assign any frequency for any purpose on the condition of avoiding harmful interference to other countries, there is good likelihood that European member-societies can arrange with their administrations for an amateur assignment somewhere in the 50-60 Mc. region for the indefinite future.

In Regions 2 and 3, the band 50-54 Mc. is allocated exclusively to amateurs.

#### AS TO HIGHER BANDS

144-146 Mc.—World wide.

146-148 Mc.—Additional assignment in Regions 2 and 3.

220-225 Mc.—Exclusive assignment in Region 2. Available also in China, South and South-West Africa and the Rhodesias.

420-450 Mc.—World wide except U.S.S.R., shared aeronautical navigational aids, the latter having priority.

450-460 Mc.—Additional assignment in Region 1 (except U.S.S.R.) and Region 3, again with priority for the navigation aids with which the band is shared.

1215-1300 Mc.—World wide except U.S.S.R.

2300-2450 Mc.—World wide, but subject to possible interference from industrial, scientific and medical service use of the band-edge frequency 2450 Mc.

3300-3500 Mc.—Exclusive assignment in Region 2. In Region 3, amateur, fixed, mobile and radio navigation share 3300-3900 Mc.

5650-5850 Mc.—World wide, subject to possible interference from operation of the industrial, scientific and medical service on 5850 Mc.

5850-5925 Mc.—Additional assignment in Region 2.

10000-10500 Mc.—World wide.

#### EFFECTIVE DATE

This is the picture we shall enter when the radio regulations of the conference become effective. Every country participating in the conference signed the regulations, and no reservations or exceptions which affect amateurs were entered. The date for those provisions affecting frequencies above 27.5 Mc. has been set as 1st January, 1949. Because of the lengthy work involved in producing

a new International Frequency List to replace the "Bern List," the effective date of regulations affecting frequencies below 27.5 Mc. will be somewhat later, tentatively set as 1st September, 1949, but subject to postponement. As concerns our international bands, therefore, we shall continue to operate under the Cairo provisions for about two more years, perhaps longer.

#### CONCLUSIONS

At the beginning of the conference it was apparent from the proposals of many nations that amateur radio would suffer some losses or shifts in present frequencies, and make some gains. Yet it is not now easy to judge accurately how amateur radio throughout the world will fare under the new Atlantic City regulations. The widely-differing philosophies of the various governments of the world toward amateur radio and its relative importance necessitated regional arrangements in numerous of our bands, and (especially in the case of 7 Mc.) the usefulness of these frequencies in some regions will depend to a large extent on their invasion by non-amateur services in other regions. Another "question mark" is the 21 Mc. band—how useful it will be, how far it will go toward compensating amateurs for the comparatively small loss at 14 Mc. and the severe cut (outside the American Region) at 7 Mc. It is our belief that 21 Mc. will be an interesting and useful band for international communication throughout much of the 11-year sunspot cycle, perhaps carrying a majority of amateur DX work. But we shall just have to wait and see.

And thus I end this brief summary of Atlantic City Conference results. I should like to add a word of gratitude, on behalf of President Bailey and myself, for the splendid cooperation and hard work of the member society delegates listed in the June Calendar as comprising the I.A.R.U. delegation.

The next world conference to revise the radio regulations is scheduled to be held in Buenos Aires, Argentina, some time in 1952. Although five years away, it is even now not too early to begin thinking about our preparations for that meeting.

The stronghold of amateur radio is in the Americas and the British Dominions. But amateur radio is and should always remain world wide, and we must never allow it to become an institution limited to a few countries. While the national amateur societies band together as the International Amateur Radio Union, it is not the Union which has responsibility for the attitudes of the various governments toward amateur radio—that responsibility lies solely with the individual member-society and its leaders. Those government attitudes are determined over a period of years, and not just a month or so in advance of a world conference.

We shall, therefore, all have to be

## SUCH NICE PEOPLE

By "GREMLIN"

My apologies blokes for the way I've been poking my thoughts at you the last couple of months and neglecting the meat. That's what happens when the receiver gets a 180 (how's that for "Blue Orchid" lingo?) and you get to thinking. The old receiver is ticking again, complete with new devices. Well, nearly complete, just the c.r.o. to get in and then beware of the sartorial perfection of your emission. You fone blokes will be able to blab to your hearts content and I'll only have to see through your QSOs. How the XYL will beam, no more interruptions to her favorite b/c serial.

3LD was trying hard with 39 c.w. CQs straight. Not good enough I'm afraid, for phone merchant 2SH produced 76 spoken ones before giving his call three times. My congrats, for that's really some spruiking, even taking into consideration my ball and chain's Ow. No wonder you changed to c.w. later on in the night. Yes, and before I forget, your c.w. is the clicky type. Gee, some guys can be unlucky.

I'll give 3XF the best clicks for the month with 3IG, 2PA and 3YD helping. 4RJ adds chirps for good measure while 3YD likes to throw in an extra dot with his v's and 3's. Better give 3PS a mention for chirps.

3AHM and 3ANL add weight to remarks in September "A.R." by friends Harrison and Buck, with punk keying, 3AHM clips the dash to no mean order, while 3ANL just breaks down. Cober Coulter, I'm all your way although I must admit I'm not too sure about honourable seafaring gent being able to send a drop. Which reminds me, must send a drop past the old pearly whites before proceeding. Ah, that's better, being phone type find great inducement to enable recommence proceeding—meaning start again (working so many South Americans gets me all screwballed).

actively thinking and planning during these next five years how the institution of amateur radio can be made stronger in our respective countries, how it can better serve the peoples of our countries and of the world, and thereby gain in respect and prestige as not only an important but also an indispensable service. As officers of the national amateur societies, we must all be alert to opportunities whereby amateur radio can be of new and improved service to our countries, and whereby it can gain increased respect and recognition from the administrations. We should soon begin to plan, too, the mechanism for our representation at the next world conference, a subject on which Headquarters will present some thoughts in coming issues of the Calendar.

K. B. Warner, Secretary.

# FEDERAL NOTES

Well, Sinister gentleladdie, sorry, nautical Minister, having waved flags for Horatio—which is ancient practice for sending a nautical drop—I'm prompted to inquire of 2ANN if he is same laddie who sported the call of 3MV before immigration. If so, your writings surprise me for an old timer, which maybe proves the old adage that when in Rome the cakes burn or something. (Now that should start something.) Incidentally, 3ANL can produce 23 faultless phone CQs before his call. That's what I say, see!

At this stage honourable Editor, may I have furtive dig at "A.R.?" This mathematical trickery, so called calculus, is too highbrow, for simple bod like "Gremlin." My arithmetical grey matter loses emission after solving 2 to 1, 5 to 4 on and other such vulgar fractions. On behalf of yours truly and other gentleblokes with mis-spent youth, more practical articles PLEASE.

Splashing provided by 4KO, 2GU, 3UP, 3VM, 2DI, 6RU, and 4HG with a solid hum. Some hum on 4ED's transmission but believe you have been off colour Tom so don't worry until you are fit again. Speedy recovery o.m.

3FU, your phone is badly distorted when tuned to centre of the carrier. Improves on the sidebands if that's any help. That power control of yours has some effect on the quality, so maybe the correct drive to the final produces best results.

Thinking what a really punk note commercial had hopped into the 14 Mc. band when it turned out to be 3FS. I guess this is about the worst rock crusher to date. 3FP your phone is splashing on the high side. Shame on you after my bouquets on 813 use.

Now I'm an "Amateur Station Licencee" what can I do I couldn't as an "Experimental Station Licencee?" Please help me out just in case I'm missing something.

4UX complains he lives in a noisy area and is afraid he might get the blame. All I can say o.m., you are lucky to have gone so long. Everything from the failure of the gas supply to the cat drinking the neighbor's milk has been blamed on my poor inoffensive rig.

3ES, your carrier is a bit rough. An e.c.o. Roy? Heard 3SZ nattering away on the low end of 14 Mc. during the c.w. DX contest. I admire your courage o.m. Distorted phone from 3DS.

Heard this one night, "3AJE the most powerful station in St. Kilda by the sea." To me there is only two possibilities. Either Jack is only Ham bloke in this St. Kilda hamlet or the only one there to use his hundred watts allowance. Both a bit unlikely methinks!

No need for you chaps who write me to send stamped envelopes for replies. Thanks all the same.

Cheers and here's wishing you a blonde fairy for Xmas. P.S. Seems

## W.I.A. NATIONAL FIELD DAY 1948

### General Rules

1. The Wireless Institute of Australia's National Field Day Contest will be held over the week-end of 24th and 25th January, 1948, and will commence at 1500 hours E.A.S.T. Saturday 24th and continue through until 2359 hours E.A.S.T. Sunday 25th.

2. The Contest is limited to portable stations operating within the Commonwealth and its Mandated Territories.

3. A portable station, for the purposes of the Field Day, is defined as one whose power is not obtained from either private or public mains, shall be located not closer than 5 miles to the home location of the operators, and shall not be situated in any occupied dwelling.

4. No apparatus is to be set up or erected on the site of the portable station earlier than 6 hours prior to the commencement of the Contest. A station may be moved from one site to another within the same State during the period of the Contest.

5. More than one operator may be used in operating the portable station, providing that all operators are licenced amateurs.

6. Operation may be on any of the recognised amateur bands, and more than one transmitter may be used, provided that only one transmitter is used at any one time.

to be a lota VK3 types in this, so here goes—(Snooper "Gremlin" of E layer, F layer, Flemington, Randwick and other layer places).

7. When calling, portable stations are to use the letters "W.I.A. N.F.D." frequently to indicate that they are portable stations. Attention is directed to the requirements for portable stations by Regulations 27 and 28 of the P.M.G.'s. Handbook, January, 1946.

### Sections

8. The Contest is divided into three sections, namely, Open, C.W. and Phone sections. The Open Section shall consist of both Phone and C.W. operation. Participants may enter for all sections, provided a separate log is submitted in each case.

### Logs

9. Logs must reach the Federal Executive not later than the 15th February, 1948, and the decisions of the Federal Executive in all matters relating to the Field Day will be final.

10. The operator/s will choose the best consecutive 24 hours of operation from the total operating time of 33 hours, and submit this 24 hour period, as their log for the Field Day. Any lesser period than 24 hours may be operated.

11. Logs must show the location of the portable, name and call signs of the operators in the party, a description of the transmitter/s, receiver/s, antenna/e, and the power supplies used for the transmitter and receiver. The power input to the final stage with the antenna connected (which must not exceed 50 watts), will also be shown in the log.

12. Log entries are to show (in the following order), the Date, Time, Station worked, Amateur Band used, Report sent, Report received, Con-

# GLO-RAD

EXTENDS TO ALL AMATEURS

Sincere wishes for a Merry Christmas  
and a Happy New Year.

At this age-old season of goodwill "GLORAD" is able  
to review with pride the achievements of the past.

"GLORAD" is extending its plant in readiness for YOUR  
1948 demands for well engineered equipment and  
faithful service

73's

FROM

GLORAD ENGINEERING SERVICES

186A Riversdale Rd., (Cr. Robinson Rd.)

HAWTHORN ————— VICTORIA

Phones: Day—WA 3819. Night—WX 3440

# McGILL'S

Established 1860

JUST ARRIVED — RADIO CRAFT LIBRARY  
9 NEW BOOKS

Each book in this new series is crammed full of meaty material for immediate, practical application. All are set in modern easy-to-read type, carefully printed and illustrated.

PRICE: 3/6 each and 3d. post (Each).

- **HANDY KINKS AND SHORT CUTS.**  
A compilation of practical methods of overcoming difficulties encountered by every radio man.
- **UNUSUAL PATENTED CIRCUITS 1944 to 1946.**  
A digest of new radio electronic patents. Valuable to anyone in the Electronics field.
- **RADIO QUESTIONS AND ANSWERS.**  
Here are answers to questions most frequently asked. Many diagrams.
- **ADVANCED SERVICE TECHNIQUE.**  
An up-to-date collection of information on specialised phases of servicing, appealing to the advanced serviceman.
- **AMPLIFIER BUILDERS' GUIDE.**  
It contains a wide range of technical data on amplifier design followed by constructional details for a variety of amplifiers.
- **AMATEUR RADIO BUILDERS' GUIDE.**  
Here is a guide for the "Ham" who builds his own. Divided into sections on receivers, transmitters, antennas, converters and other equipment. This book is packed with information.
- **RADIO TEST INSTRUMENTS.**  
Every radio man can use this new book on building test equipment.
- **ELEMENTARY RADIO SERVICING.**  
How to get started and keep going. A wide range of essentials is covered.
- **HOW TO BUILD RADIO RECEIVERS.**  
Here is the book for the set builder. 18 modern sets are described including Shortwave, Broadcast, V.H.F., Portable, A.C. operated, and miniature types.

Plus Exchange.

## McGILL'S AGENCY

183 ELIZABETH STREET. — (The G.P.O. is opposite) — MELBOURNE  
Telephone: C. 8113-4.

tact Points claimed and Bonus Points claimed. A summary at the conclusion of the log will facilitate checking.

13. The completed log will be signed by the operators, with a statement that the Rules of the Contest have been adhered to.

### Scoring

14. For the purposes of the Field Day, the following will constitute separate districts:—New South Wales (VK2), Victoria (VK3), Queensland (VK4), South Australia (VK5), Western Australia (VK6), Tasmania (VK7), Northern Territory (VK5) and Mandated Territories (VK9).

15. Contacts within a district cannot count as a score, and a complete exchange of reports (RST) is necessary before any points are claimed.

16. Points will be awarded as follows:—

	Points
(a) For contacts with a fixed station within the Commonwealth, outside the competitor's State	1
(b) For contacts with stations in Asia, North America, and Oceania (outside Australia)	3
(c) For contacts with stations in Europe	5
(d) For contacts with stations in Africa and South America	7
(e) For contacts with other portable stations in the Contest in districts (as Rule 14)	10
(f) For every two-way contact	

- using frequency modulation, add to the above contacts .... 3
- (g) A Bonus for each Continent worked on each band (see official I.A.R.U. map for the boundaries) added to the final score ..... 25
- (h) A Special Bonus for each Interstate or Overseas Contact on, or above, the 50 Mc. band, added, to final score ..... 50

### Awards

17. A Special Certificate will be awarded to the outright winner in each, the Open, Phone, and C.W. sections.

18. A suitable Certificate will be awarded to the Sectional Winners in each district for which the outright winners, as above in Rule 17, are not eligible.

### APPLICATION FOR DX CC

The first application for the DX CC has been checked and found correct. It is R. Tandy, VK3KX, who has 106 countries in the Open Section.

### ADDITIONS TO OFFICIAL LIST OF COUNTRIES

Please take note that the Isle of Man is now an official Country (prefix GD) and the prefix for the Marshall Island is now KX6.

### ANTARCTIC EXPENDITION

In the middle of November the first party of the Australian National Antarctic Research Expedition left Melbourne by LST 3501 for Heard Island (position 53°S 073°E) where

a Meteorological and Radio Station will be established.

Four Radio Operators sailed with the party and will remain there for a matter of twelve months. The names and calls are:—

Len Macey, VK3OY (Sydney).

Alan Campbell-Drury, VK3ACD (Melbourne).

George Compton, VK3AMG (Kalgoorlie), crystal frequency of 7090 Kc.

Arthur Scholes (no call sign), of Sydney.

Station (commercial) equipment consists of AT20s, AR7s and an AT5/AR8. 3OY has a ten watts Type 3 Mk. 2, while 3AMG and 3ACD have 5 watts Type A Mk. 3 transmitter-receivers. With suitable aerials they hope to be able to contact any interested VKs.

It is not expected that much will be heard of these stations before the end of January. At the present time it will not be possible to arrange skeds as the immediate work of making camp will consume all time and energy. When work settles down some arrangement will be made probably through Federal Headquarters to publicise the hours and frequencies. As it stands the frequencies should be 3.5, 7 and 14 Mc.

In January another party will leave for Macquarie Island with operators Jeff Mottershead, Peter King and Gersh Major (VK7AE).

# FEDERAL QSL BUREAU

## RAY JONES, VK3RJ, MANAGER

Advice has been received of a new award made available by the R.S. G.B. for two-way contacts with 50 or more Empire countries. Some of the conditions are a trifle vague and action has been taken to have the position clarified. Full particulars of the award will be published in this column when the position is fully established.

Stations receiving cards which are not intended for them, are requested to return them to their state Bureau as soon as possible. Due to bad writing by the originator many cards are received with calls which are difficult to decipher and of course with the large volume of QSL traffic being handled, a few misprints are inevitable. Stations can help by returning them promptly.

For the benefit of new licencees the addresses of the State Bureaux are again published:—

N.S.W.—VK2YC, Mr. J. B. Corbin, 78 Maloney St., Eastlakes, N.S.W.

Vic.—VK3ZB, Mr. G. Roper, 26 Lucas St., Caulfield, S.E.8, Vic.

Qld.—VK4EN, Mr. E. Neale, 38 Felix St., Woolloowin, N.3, Brisbane, Qld.

S.A.—VK5RX, Mr. G. Luxon, 8 Brook St., West Mitcham, S.A.

W.A.—VK6RU, Mr. J. E. Rumble, Box F319, Perth, W.A.

Tas.—VK7AL, Mr. T. Allen, 6 Thirza St., Newtown, Tas.

Papua—VK9GW, Mr. G. A. Warner, care O.T.C., Port Moresby, Papua.

Envelopes for incoming cards should be sent regularly to the QSL Manager for your district.

Applications for awards should be sent with the cards either through your Divisional Secretary or direct to the Federal QSL Manager, VK3RJ, Ray Jones, Box 2611W, Melbourne. An envelope should be enclosed for the return of cards.

In Victoria, outward cards together with remittance to cover the QSL charge of one half-penny per card, should be sent to VK3OF, Frank O'Dwyer, 190 Thomas St., Hampton, S.7, Vic.

Would some Spanish student please give me a translation of the following:—"Por una falta nuestra, comedia al enviarme anteriormente una correspondencia adjuntandole QSLs, falta del franqueo correspondiente. Es porque que le estamos adjuntando un Cupon Internacional a fin de hacerle efectiva la cantidad por uds. Aportada a dicha correspondencia. Esperando nos perdone el error cometido. Nos reiteramos do Ud. Atto. y S.S." Thanks in anticipation of a prompt translation so that a reply may be sent if necessary.

The QSL Manager for the Netherlands makes the following request. Would QSL Managers and others mailing cards to the Holland bureau

—V.E.R.O.N., Box 400 Rotterdam, Holland, please put different value of stamps on the letters or packages, to further the collection of the Manager.

Advice is to hand from Austria that the O.V.S.V.—the pre-war Ham society for Austria—has been reformed and has official blessing. It now has 415 members. Willy Blaschek (ex-OE3WB), the QSL Manager pre-war, is again acting in the same capacity in addition to the secretaryship of the reformed body. Transmitting licences have not yet been re-issued but it is hoped to obtain them shortly. The society sends its greetings to Australian Amateurs and hopes soon for the restoration of pre-war conditions. The address of the society is O.V.S.V., Kierlingerstrasse 10, Klosterneuburg, Austria.

Bernie Swedloff (W3EKK) who operated recently in Japan and the Pacific Islands with the suffix /J9 and /VK9 requests that all cards should be forwarded to him via the A.R.R.L.

"Lindy" of W8BHW ex-W2BHW, well known to old timers and to all participants in contests for many years, has recently taken unto himself a wife. After dodging cupid's darts for a few decades, he finally fell a victim. "Lindy" seems to be bringing up his new acquisition along right lines, for during contests she sits up with him and stimulates him with coffee, etc., at the right moments.

A scream from W6EYB, Lew Brown, states that he has been unable to write a card out of 25 VKs whom he lists. The only VK card he had received to the time of writing (Sept., 1947) was from VK4PX for whom he is saving a bottle of Scotch. Doesn't state whether the Scotch is a threat or a promise.

The Ham population of the Telegraph Branch, Melbourne, is steadily becoming denser. Les Jackson 3XM, Herman Asmus 3ET, Val Barnes 3OT, Roy Perry 3OU, Garney Hancock 3RY, and the writer all help to advertise our dot dash and teletype "factory" in one way and another.

This column must have some psychic effect on certain Hams. No sooner had the par relative to non-receipt by VK7JH of a card from PK6HA reached print, than the card in question duly reached Jack Hooker. Jack manfully retracts his allegations against Lt. Hagers (PK6HA) and apologises for same. So now Jack is happy and so is PK6HA. And so are we all—I hope.

When the results of the recent contest are announced by the new contest manager, Ted Jenkins (VK3QK), some mammoth scores will be tabulated. In advance I would like to congratulate Dave Duff (VK2EO) for his mighty effort, whether it is a winner or not for the c.w. section. I won't steal the Contest Manager's thunder by announcing the colossal score accumulated by Dave but if it is not a winner I promise to publicly

eat all the unclaimed cards held by Graham Roper, VK3ZB, the Victorian QSL Manager (that's a big task—Editor). So that you may work out Dave's score I will tell you that he averaged a QSO every 6 minutes of the entire c.w. periods and worked 86 countries despite the fact that Dave fell exhausted at the key at one period and slept for 5 hours during the best DX period on 14 Mc. of the test. Dave's XYL knowing in her wisdom that there should have been no DX on 14 Mc. at the period mentioned, allowed Dave to blissfully slumber. Otherwise he may have made the DXCC through this contest period. His splendid effort shows what can be done with intelligent operating, a sound knowledge of DX conditions, efficient equipment and tenacity and endurance. 100 watts in the final and a 67 foot high zepp did the job.

Eric Trebilcock, BERS 795, still at Wynyard, Tasmania, comes to light with the following DX heard on 7 Mc. during recent week-ends: (c.w.) ZS, VQ5, VQ4, SM, FT, UO, UJ, UB5 (3 stations), F (19 stations), PK3, HB, PA, ON, GW, I, GI, D2, OH, G (21 stations). It shows that 7 Mc. is as of yore—if you can get away from the city barrage.

The following W.A.C. recommendations have been made since January last:—

VK2HL, VK2NP, VK2YC (28 Mc. c.w.).

VK3PG (28 c.w.); VK3GG, VK3YS, VK3YV (28 Mc. phone); VK3XK, VK3JA.

VK4UX, VK4RC; VK4EL (28 Mc. c.w. and mixed phone); VK4HR (28 Mc. c.w. and phone, 14 Mc. c.w. and phone).

VK5JS, VK5LU; VK5MP, VK5WG (28 Mc. phone).

VK6MU; VK6RU (phone); VK6KW (14 and 28 Mc. phone).

VK7LJ.

## CORRESPONDENCE

Balcombe, Vic.

Editor, Sir,

One searches "A.R." in vain each month for articles of practical value to the average amateur. It is the considered opinion generally throughout the ham fraternity that the present time is ideal for a periodical to cater for the needs of those about to study for a licence or those recently licensed.

Surely the rigs used on 50 and 166 Mc., much ventilated in these pages, are not so hay wire that they cannot be produced on paper for the benefit of those in the categories mentioned above.

For you dear Editor I have mutilated my issues of "A.R." to paste the clippings hereon to improve this case.

$$E_{out} = \frac{Z_{out}}{Z_{out} + Z_{in} + Z_x} E_{in} \quad (1)$$

YOU'LL BUILD A **BETTER** STATION . . . . .

ON AN **EDDYSTONE** FOUNDATION

Here are just a few more of their famous  
Components for F.M. — A.M. — and PULSE



**EXTENSION CONTROL OUTFIT.**

The insulating portion of the outfit is made from precision drawn paxolin tube of high quality which cannot warp or bend. The length of the insulating part is 4", while the 1/2" brass insert is 3" long, giving ample scope for length adjustment.  
Cat. No. 1008 . . . . . 4/4

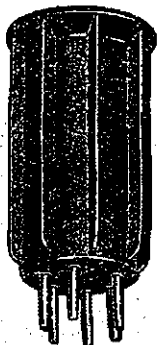

**LOW LOSS 6-PIN  
COIL FORMERS**

(Threaded or Plain Ribs)  
These 6-pin coil formers are made of DL9 material, the outside diameter being 1 1/2" with a winding length of 2 1/2". The threaded formers are cut 14 turns to the inch.

Cat. No. 537 Plain Formers 5/3

Cat. No. 538 Threaded Formers 5/11

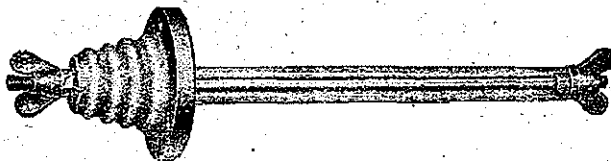

**LOW LOSS AERIAL LEAD-IN**

Consisting of special vitreous porcelain which will withstand the weather and has a long leakage path between the metal portion and earth. The tube itself is of 3/4" diameter. A special moulded watertight rubber washer fitted inside the cone prevents breakage and allows for errors in mounting.

Cat. No. 946. Length of glass tube behind insulator 5 1/2" . . . 5/7



**STAND-OFF  
INSULATOR**

Made from special quality white vitreous porcelain, glazed finish, with hollow centre. All metal parts being heavily nickel plated.

Cat No. 916 . . . 2/1



**RADIO FREQUENCY CHOKE**

D.C. Resistance . . . . .	10.53 ohms
Inductance . . . . .	1.5 millihenries
Working Range . . . . .	60-1.5 Mc/s.
Current Capacity . . . . .	250 m/amps.
Cat. No. 1022 . . . . .	3/3

**DIRECTORY OF DISTRIBUTORS**

- VICTORIA: J. H. MAGRATH & CO.  
208 Little Lonsdale St., Melbourne
- WEST AUST: CARLYLE & CO.  
Hay St., Perth & 397 Hannan St.,  
Kalgoorlie
- N.S.W: JOHN MARTIN PTY. LTD.  
116-119 Clarence St., Sydney
- S.A: GERARD & GOODMAN LTD.  
192-196 Rundle Street, Adelaide
- Q'LAND: CHANDLERS PTY. LTD.  
Cnr. Albert & Charlotte Sts. Bris.
- TAS: W. & G. GENDERS PTY. LTD.  
53 Cameron Street, Launceston

Australian Factory Representatives:

KEITH HARRIS & CO. PTY. LTD. 51 WILLIAM ST., MELB. Tel. MB2119

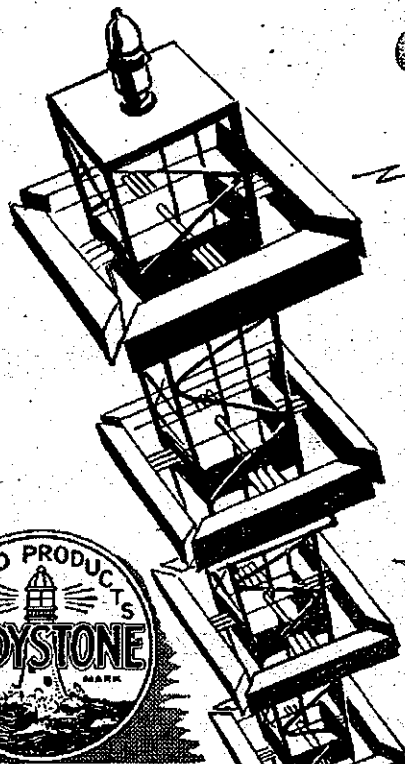

**EDDYSTONE** OFFERS YOU  
THE LATEST, MOST DEPENDABLE  
COMPONENTS for FM., AM., & PULSE



# FIFTY AND UP

COMPILED BY VK3QO

$$Z_{x \text{ pat}} = \left\{ \frac{C1}{C1 + C2} \right\}^2 \times Z_{\text{pat}} \dots (3)$$

The first two extracts are from the October issue. I consider it safe to say that many of your readers "gave the article away" at first sight when these met their eyes.

If one needs a crystal filter in his receiver the necessary details regarding its construction are clearly set out in other hand books. Many Hams are concerned little whether  $Z_{1n}$  plus  $Z_x$  enters into it or not.

The following clippings are from "A.R." of February and May, 1947:—  
 $i_1^2 r_1 + i_2^2 r_2 + i_3^2 r_3 + \dots = W \dots (5)$   
 From (4) and (5) —

$$Z_1 = r_1 + \frac{i_1^2 r_2 + i_2^2 r_3 + \dots}{i_1^2} \\ = r_1 + \frac{W - i_1^2 r_1}{i_1^2} \dots (6)$$

$$\text{area ratio } D/C = \left\{ \frac{\sqrt{Z_0}}{\sqrt{Z_1}} \right\} - 1 \\ = \left\{ \frac{\sqrt{72}}{\sqrt{9}} \right\} - 1$$

equals  $(\sqrt{8}) - 1 = 2.83 - 1 = 1.83$   
 diam. ratio  $D/C = \sqrt[3]{1.83} = 1.35/1.$

The diameter of D = 0.75-inch.

These articles used quite a deal of space without disclosing to the learner much useful practical information.

I am not criticising the writers of these articles, I would rather infer that the articles concerned deserve a place in a higher technical journal. I say that what the majority of your readers mainly desire is easily written articles which will assist them to put an efficient rig on the air, to obtain good reception through interference plus dope on rotatable beams.

It would be quite wrong I know to suggest that some of the contributors produce these highly technical articles to advertise their considered technical ability, but this impression may possibly be created in some quarters. I venture to say that the two articles on folded dipoles "got no one anywhere."

The number of budding amateurs at the present time is enormous—these need encouragement — not fright. They desire articles to be described on their own level. Those with a background of algebrae can have easy access to well known technical manuals.

Articles similar to those I have mentioned would not be given space in a journal such as QST, the contributor would probably be referred to publications outside the normal amateur sphere.

Well now this is a plea for the starter in Amateur Radio, a plea considered amply justified but perhaps a little late. However I aim to give a lead in this matter by airing these views and any support or criticism which results from this letter may be a guide to you in your future planning.

Yours sincerely,

GEO E. EVERY, VK3GE.

On Tuesday 23th October W6NYV was heard on m.c.w. by VK4FN and VK4BJ, in Brisbane and Bundaberg respectively, the time being 2100 hours E.S.T. Needless to say many were the calls and many were the ears glued to speakers following this exciting episode, but equally many were the disappointments.

It would be interesting to know what power W6NYV was using, and since the receivers at both ends could be assumed to be about the same, the lack of contact could have been due to the American not listening, or the VKs not having enough power.

Clarrie Castle (VK5KL) has at last received confirmation of his contact with W7ACS/KH6 on 50 Mc. on 26th August. Cheers o.m. and do it again. W7ACS is still running skeds with VK5KL at 1200 and 0230 C.S.T. W8UXN is also on from 1200-1300 C.S.T.

With reference to the VK5KL-W7ACS/KH6 contact, the Radio Research Board records have been consulted by the Australian Radio Propagation Committee with the object of ascertaining state of the ionosphere along the assumed great circle path of transmission between Darwin and the Hawaiian Islands, and it is found that predicted conditions for the month of August give maximum usable frequencies of 45 and 37 Mc at the Hawaiian and Darwin control points respectively, at 1200 hours Australian Central Standard Time. Since these predictions were about 10% low for August, you will see that the average m.u.f. for this circuit was about 41 Mc. (37 Mc. plus 10% of 37 Mc.).

Now normal day to day variations in F2 region critical frequencies can be as much as 15-20% above or below the average, so if we suppose that 26th August, 1947, was a normal day, it would be quite likely that F2 layer transmission between the places considered would take place on 50 Mc.

It is not anticipated that long distance 50 Mc. transmissions will be possible with any regularity (even in equatorial regions) but trends in sunspot activity and F region composition tend to show that over selected paths, such as the one under discussion, quite a number of contacts should be made from Northern Australia by trying at the right time. These conditions should prevail only for a few months, however, any opportunities lost now may not be regained for many years, since this sunspot maximum is reaching a high value which, following maxima, may not approach for the next few cycles.

VK5KL reports that on 5th October, ZS1P, on 50 Mc., worked a G (on 28 Mc.) crossband, 12th October W7ACS/KH6 made 20 contacts in one hour with stations in Stateside. 18th October at 1100 E.S.T. J9AAO

worked CEIAH on phone to make a new record of approximately 11,000 miles. During October 12-13-14 at 1200-1300 hours in Darwin the band was apparently open towards U.S.A. as VK5KL could hear a phone station with QSB just outside low frequency end of band. On 28th October W1s were heard by G5BY and it is believed that he worked some cross-band. J9AAO on c.w. was heard by W6UXN who used a kilowatt without result in trying to contact him.

## INTERSTATE DX NOTES

On the 9th November about midday seven VK2s worked the VK5 boys and afterwards at 1400 hours 7XL reports following stations were worked from 7XL: 2BZ, 2ADT, 4KB, 4ZU, 4RY and 4CU. Reports were S8-9 all round. The VKs could not hear the VK4s and vice versa. 2ADT reported that he followed all the QSOs and re-broadcast 7XL on 7 Mc. 7XL contacted 7AB at 1730 on sked and a close watch was kept from then on. The band opened up again from 1820 to 1845 and again at 1900 for a few minutes, 7AB working 4ES, 4RY and 4ZU, while 7XL worked 4ZU, 4ES, 4FB and 4RY. 7XL and 7AB were running about 90 watts apiece in conjunction with rotary beams.

Meantime 7CW was on in Hobart but heard nothing. On Wednesday 12th, however, the band suddenly came good a little after 1930 and he worked 4HR, the first VK4 contact from that end of Tasmania on 50 Mc.

At 1930 on 9th November, 3RR heard 4PG moaning that he had been hearing 3ED, 3RR and 7AB since 1855. 4PG worked 3ED till 1948, then 3RR till 2003 with signals S9. 4ZU was S6-7 from 1945-2230 at 3RR.

Wednesday 12th at 1315 the band opened in spectacular fashion with 4HR working 3VL, 3HK, 3GE; 5GB worked 4HR at 1330. In the evening, VK2s, VK4s and VK7s were heard in VK5. At 1830 3BD and 2LZ contacted. At 1900 4ZU had a really fine contact with 7XL which lasted for 35 minutes with S9 signals both ways; 7AB also worked 4ZU at 2000 hours. The band was also open again on 13th, 14th, and 15th.

It would be appreciated by your scribe, if contributors to Fifty and Up would make their DX reports on standard log forms, accompanying same with their experiences and comments on a separate sheet. Send direct to 3QO, 32 Redesdale Road, Ivanhoe, Victoria.

## VICTORIA'S FIELD DAY

It was VK3's turn to have wet weather on their field day on 9th November. The stations out were 3YS-3ABA at Mt. Macedon; 3HK at Ridge Road, Mt. Dandenong; 3VL was at Arthur's Seat; 3MB went to Mt. Wirth about 10 miles from 3HZ at Warrigul; 3ABG was in wild bush

Amateur Radio; December, 1947

country on a 1600 ft. range 10 miles from Avenel. 3LS operated first from Mt. Bunninyong near Ballarat, then later at Pentland Hills, and 3RR operated fixed portable at Macrae.

Some good contacts were had by all on both 50 and 166 Mc., although on the latter band some QRM was noticeable.

#### 50 MEG NOTES

3BQ's locality is evidently affected by windy "Gremlins" who push his beam aerial down frequently; rather grim as Max is a very busy man and also as he very carefully tunes up each beam! Said "Gremlins" also visit 3RR. They bored a hole in a mica condenser in his 829B final with interesting results! Then they sneaked into his power transformer and chewed that up. 3BD erected a beam which projected slightly over his neighbor's property. Said neighbor moaned and insisted that beam come down; Nice People! 3VL made his first contact with 3GM at Ballarat on 16/11/47. 3VL and 3HK have been doing some portable work on their own lately at Arthur's Seat and worked 3HZ, 3IV, 3ZL, 3GM and 3SE (at Bunninyong).

VK4s have been reasonably active. 4HR was very disgusted on the 9th when the DX came through because he had given radio away for the day, having just painted his shack!

The V.H.F. boys in VK2 were delighted to hear of the success achieved by country members Alan Thackeray (2TA) and Ross Weedon (2PN) in making a two-way contact between Young and Tumut on 50 Mc. The distance is about 80 miles and represents the culmination of much hard work and enthusiasm over quite a period. City fellows cannot quite appreciate the helpless feeling of country Hams beefing out signals not knowing whether anyone is listening or not. Apparently this channel is to be a permanent one, as signals have been heard for two successive weekends on schedule as we go to press, with the aid of 2TC's superhet. Jim is another of the gang hard at work on the band. Others in the surrounding district are very keen to broaden the country chain, and this success should give them a new incentive.

VK5 boys have one comment to make to the VK2s using m.c.w. It is much better to read on a fading signal than c.w., but would be a lot better still if the carrier was keyed as well as the tone. In some cases it was impossible to use the b.f.o. as the carrier surge wiped out the modulation. When the signal went down the b.f.o. had to be switched in again to hear anything at all. For the interest of kid beaters and chalk spreaders in other States interested in 50 Mc. during the Christmas vacation, there will be a couple of VK5 stations on during at least part of that time. Contact 5QR for daytime skeds.

Heard that 5RT had a good QSO with 2AMI who was using 6 watts to 6V6s in p.p. feeding indoor aerial

# QUIET

## PERMANENTLY

*Silent Spiral  
Connector...*



NO SLIDE  
NO FRICTION  
NO NOISE

*5-Finger  
"Knee Action"  
Contact*



AMAZINGLY  
SMOOTH...  
PERMANENTLY  
QUIET

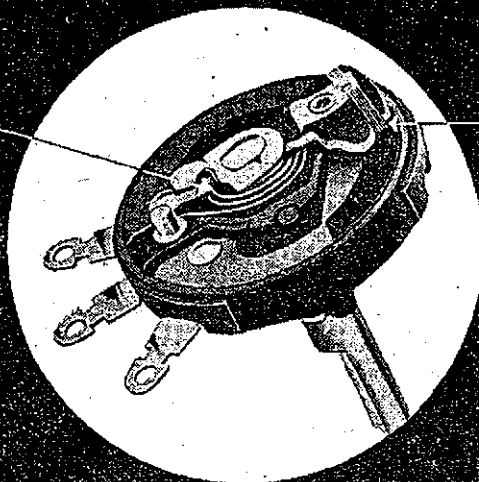

# IRC VOLUME CONTROLS

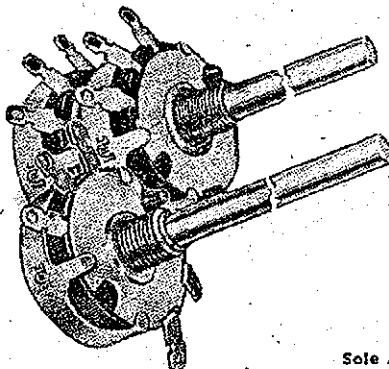

IRC HAS SPARED NO EXPENSE SO THAT  
YOU CAN BE SURE

Study the design of IRC Metallized Controls. Note in particular the precision construction of the 5-finger "Knee Action" Silent Element Contact and the new Silent Spiral Connector.

Each of these exclusive features means thousands of pounds in research by IRC engineers. Each means additional manufacturing expense—yet IRC Controls cost you no more than ordinary controls having neither of these noise-eliminating features.

It is "plus" values such as these that have made IRC resistance products famous the world over. By giving you the greatest value for your money, by doubly insuring you against customer complaints, we protect our reputation by helping you protect yours. That is good business for both of us.

Sole Agents for Australia:

## Wm. J. McLELLAN & CO.

BRADBURY HOUSE, 55 YORK ST., SYDNEY • PHONE BX2508

hanging from back of his chair to shelf over his rig; S9 both ways! Who said QRO and beams!

Some good news this month—6GM is on the band with f.m. on 52 megs. 6FB of Mullewa is ready now using p.p. 807s with 22 watts (220 v. d.c. mains). Look for him on 51.77 Mc. after 8 p.m. 6HT and 6WG of Albany both ready and looking for contacts with Perth between 8 and 9 p.m. frequencies not yet known. 6RL of Northam still not yet contacted Perth, but with increasing possibilities of sporadic E, it should not be long before new records are established in VK6. The city regulars are still go-

ing strong with the contacts being made almost nightly. 6TC is busy erecting dual 28 and 50 Mc. three element beam. 6GM's first day on 50 Mc. was very successful, with good reports coming from 6GB, 6FC and 6LW plus others from some of the many enthusiastic s.w.l.s now active on this band. Expect to hear many new f.m. signals on this band following the showing of the f.m. at the last W.I.A. monthly meeting.

In VK7 only reports are from 7AB who says that the only activity on the N.W. coast is himself and 7XL. They have kept skeds for 13 years on different bands and 50 Mc. appealed to them as a band all to themselves.

#### 166 Mc. JOTTINGS

Things are very quiet in VK3. 3ACM wants me to say that 50 watts on an 815 at 168 Mc. is too much and if we get 144 Mc., full ratings will be O.K. 3ACM reckons cross-band contacts might stimulate activity.

Activity on this band is at a low ebb at the moment due no doubt to the necessity for keeping ears peeled on 50 Mc. 4XG has a super-duper rig nearly finished, a multi-band job which sounds rather like a dream rig if Gus' enthusiastic account is a criterion. 4ZU has put his 522 transmitter on 50 Mc. in readiness for prospective field days. 4KB and 4RT are playing around with converters, broad-banders and otherwise. The combination of 6AG5, r.f., 6AC7 mixer, and 954 oscillator is rather a good one as far as 4ZU is concerned. Signal to noise ratio is very good and the arrangement has a ton of gain.

4HR has very successfully converted his 522 to both 50 and 166 Mc. as has been recounted on a previous occasion, but Gus (4XG) intends adapting his to double conversion using one stage of 10 Mc. i.f. and a couple of 1600 Kc. stages later on in the line.

5SP made his debut on the band on 23rd October. Quite a good signal using p.p. 7193 oscillator into a J antenna. Receiver, two tube super regen. 5GB can only be heard on this band on request. What's happened to the re-broadcasts on Sundays, Geo? 5JD has had the band to himself for the past two months. Spent the time making some improvements (he hopes). Is now preparing a rig for the jalopy—to be used on VK5's coming field day. 'Tis rumored that 5KZ will be more active in the coming months.

5JD's search for a means of reducing or eliminating super-regen hiss has had some result. Remains now for others to adopt the idea and comment. A condenser of 100 mmfd. is connected from plate to grid of the audio amplifier. This attenuates the highs, washing out most of the objectionable hiss. Larger values completely eliminate the hiss but with some loss of signal which may or may not be acceptable.

## DIVISIONAL NOTES

### NEW SOUTH WALES

Secretary: Peter H. Adams, VK2JX  
Box 1734 G.P.O., Sydney.  
Meeting Place: Science House, Gloucester and Essex Streets.  
Meeting Night: Fourth Friday of each month.

A discussion on Convention items was the chief business at the October meeting of the N.S.W. Division, held at Science House on 24th October, with President Morrie Myers in the Chair.

Rather too much occurred to be detailed here, but decisions were reached on all matters not previously dealt with, including the subject of "Amateur Radio" and the suggestion for a paid Federal Secretary of the Institute.

The general feeling of the meeting on this point is that whilst the Division agrees in principle with the idea, and even feels that sooner or later it is inevitable, it was not so enthusiastic concerning the method proposed to bring it about. Furthermore, the Division's own administrative problems, due to the great expansion made since the war, are sufficiently urgent as to give them a higher priority at present even over Federal matters.

Probably only the Victorian Division can realise the terrific amount of work entailed in looking after the requirements of more than 500 members scattered all over the State. That Division has already found itself requiring paid help on the job. A similar position might yet be forced upon N.S.W. if suitable arrangements can be made. We realise that stability and strength in the Division is of prime importance, without which there would soon be no Institute at all.

After considerable discussion the meeting endorsed its desire to see the uniform Federal Constitution brought into being, and members are hoping that some action on these lines will be forthcoming very soon.

The meeting also approved a motion allowing radio clubs to achieve Member Club status with the Division. A section of the arrangement allows Clubs having sufficient members, and sufficient Institute membership, to nominate an ex-officio member of the State Council, who will have direct access to any Council meetings where Club matters are discussed. There is also a provision whereby non-Institute club members will pay the ruling per-capita fee to Federal Executive, thus identifying themselves with W.I.A. Federal policy, and assisting its implementation. It is hoped that the new plan will allow an official link with the clubs, not now provided for by the N.S.W. Constitution. Amendment action will be taken to the Constitution to include the new plan.

# Bright Star Radio

VK3UH

1839 LOWER MALVERN ROAD

GLEN IRIS, S.E.6, Vic.

Phone: UL 55:0

TAYLOR TRANSMITTING  
TUBES

Full Range

Crystals as illustrated.



40 and 80  
metre.  
AT or BT  
cut. Accu-  
racy 02% of  
your  
specified  
frequency.  
£2/12/6

20 metre zero drift, £5.

Crystals Reground, £1 each  
SPECIAL!

BENDIX FREQUENCY  
METRES.

Complete with calibration  
book, in perfect order.

Know your frequency within  
cycles. The ideal V.F.O.  
£30 each

Filament, Power and Modulation  
Transformers Constructed.

Prompt Deliveries.

Screw Type Neutralizing Con-  
densers (National Type) to suit  
all triode tubes, Polystyrene insu-  
lation, 19/6 each.

## NEWCASTLE ZONE

The opening on 9th November of the 50 Mc. band saw some fine contacts. Details will be found in Fifty and Up. Newcastle stations are working to Sydney, Cessnock, Wyong and Toronto regularly on 50 Mc. 2AHA rebroadcasting 50 Mc. signals; results, some 7 Mc. gang building converters. 2CI has a converter on 50 Mc. and is working on the Xmitter and aerials. 2PQ on 28 Mc. with nice phone and is awaiting co-ax for the beams. 2AGD building a really fine Rx and takes time off to work 28 Mc. DX. 2FP is taking things steady after DX Contest and has some 50 Mc. gear on the way. 2ZC resting after a fine DX Contest effort. 2TE nearly completed a new v.f.o. and is also putting up a dural 28 Mc. beam.

## COALFIELDS AND LAKES ZONE

2YO busy with work and not active, has plans for rotary and revamped Rx for 28 Mc. 2KZ exclusively on that band and chasing W.A.S. 2KF no news of the newcomer although heard on 14 Mc. 2XT heard Sundays on 7 Mc., how about trying 50 Mc. for local work Bill? 2TY last heard of on 28 Mc. trying V beams for South America. 2PZ still not very active, better get some more gear perking Chris. 2ADT got a high placing in the phone section of W/VE Contest; spends most of his time on 50 Mc. and broke through to VK7.

2YL at last established on 50 Mc. phone, using long wire antenna (a beam to be erected shortly); worked 28, 27, 14 and 7 Mc. in DX Contest. 2OC very keen on 50 Mc. and is on from 1900 to 2000 hours most evenings. 2RU keeps Gosford on the map with 50 Mc. activity. 2AEZ a keen 14 Mc. DX man with plenty of countries. 2KR very active on 7 Mc. phone, any news of activity in your area would be appreciated Cec.

## WESTERN ZONE

2HC on 3.5 Mc. with nice Telefunken phone, genemotor power supply and V beam. 2IE mad with the DX, exclusively on 14 Mc. 2WH has cleaned up the quality and is fine now; V beam still won't work; has a new Bendix freq. meter. 2BT has AT5 working nicely with the assistance of a c.r.o., a new one. 2II has now a 28 Mc. beam above the 14 Mc. job. 2AMR is still building super shack above the garage. 2ACT heard occasionally with good phone on 7 Mc. 2NS almost completed the rebuilding campaign, has another new Receiver.

2LZ heard on 7 Mc. one night using c.c.? 2HZ has shifted gear from the lounge room and is still building super Receiver. 2ALX working DX on 28 Mc. with AT20. 2TG still on 14 Mc.; DXCC should show up soon. 2ACU now at Coonamble using a AT5/AR8. 2ZX using full 100 watts plate modulation with excellent results. 2QA still settling in new house,

intending to build 14 Mc. beam. 2LY still rebuilding, undecided where to start. 2AFO and 2FI on the V.H.F.s. exclusively.

## SOUTH COAST AND TABLELANDS ZONE

2AKE is using only 2 watts to a 19, modulated by another 19 and 135 volts of battery. 2DO, 2AKE and others are organising for bush fire emergency work. 2TC, 2TA and 2VS in the Young district are active on 50 Mc. 2TA has been heard by 2PN in Tumut. 2ALS with 4 watts phone and an AR8. 2ALD in trouble with buildings going up beneath his antenna.

2GU using a.m.c. on 7 Mc. phone. 2IT a new one from Moss Vale. 2ACU should be home again shortly. 2ADI spent a week in hospital after turning over his truck, OK now. 2ANN on plate modulated phone, modulating the 813 with 830Bs. Congratulations to 2EO on winning the W/VE Contest.

## SOUTHERN ZONES

2OJ rebuilt Receiver and very pleased, the tower is ready to erect for the beam, proceedings stayed with daughter's illness. 2EU to quote: "dreaming up a new rig for the new QTH." 2ANQ rounded up shekels and departed for Stawell on leave, new rig nearly finished and an oregon mast painted ready for erection. 2VK relieving 2ANQ on the service bench, busy on a service oscillator when not talking filters with 2APW who is building xtal filter and works DX when finished on the b.c. station. 2VS transferred from Canberra to Young, did the boss see the "A.R." notes,

## VICTORIA

Secretary: A. B. D. Evans, VK3VQ,  
Box 2611 W.G.P.O., Melbourne.  
Telephone: FJ 6997

Meeting Night: First Wednesday of each month.

Meeting Place: Radio School, Melbourne Technical College.

## XMAS GREETINGS

As President of the Victorian Division I send greetings to all members and trust that a Happy Xmas will be with us all. There is a lot of activity in the hands of your Council right now and the New Year should see rapid strides in general Divisional affairs. We are busy on the beam, but always have time to listen to news and views—whenever you like.

Lots of DX and 73

Bob Cunningham, VK3ML.

It is evident, once again, that the fullest interest and enthusiasm of members is shown by their attendance in numbers at the general meeting held in Melbourne on Wednesday, 5th November.

At this meeting our President introduced Mrs. O. I. Cross who was appointed to the position of administrative Secretary to the Division and was warmly received. Mr. Cunningham enthused on the prospects of future organisation of Divisional affairs that must follow this appointment.

Welcome visitors to the meeting were Mr. Ross Harris (VK5FL), well known South Australian Divisional Councillor, who presented viewpoints on behalf of his Division. Mr. Frank Russell, from Portland, Oregon, U.S.A., who operates a rig under the call sign W6XVK, and Mr. A. G. Sabin, VK2AGS, also visiting Melbourne. Mr. Compton, VK3AMG, who was present, advised that he will accompany the "Wyatt Earp" on its South Polar Expedition as far as Heard Island and will operate from that location. Many interesting QSOs should result from contact with VK3AMG during his stay on Heard Island.

The recommendation of Council to increase subscriptions was put to the meeting and unanimously carried. The new rates to operate from the forthcoming financial year are as follows:—

Metropolitan Members: Full 25/-,  
Associate 22/6, Student 10/6.

Country Members: Full 22/6, Associate 20/-, Student 10/6. (A rebate of 2/- is made to Zones in the case of each Full and Associate membership subscription).

## WI BROADCASTS

All Amateurs are urged to keep these frequencies clear during, and for a period of 15 minutes after, the official Broadcasts.

VK2WI, Sundays—

1100 hours E.S.T., 7190 Kc.  
2000 hours E.S.T., 50.4 Mc.  
No spot frequency checks will be available from VK2WI.

VK3WI, Sundays—

1130 hours E.S.T., 7196 Kc.

VK4WI, Sundays—

0900 hours E.S.T., 7100 Kc.  
0900 hrs. E.S.T., 14358 Kc.  
0900 hours E.S.T., 52.4 Mc.  
Frequency checks are given two nights weekly. Hours are announced during the Sunday broadcasts.

VK5WI, Sundays—

1000 hrs. S.A.S.T., 7195 Kc.  
Spot frequency checks may be obtained from VK5DW on Friday evenings on the 7 and 14 Mc. bands.

VK7WI, 2nd and 4th Sundays—

1030 hours E.S.T., 7174 Kc.  
No frequency checks are available from VK7WI.

Entrance fee will be 10/6 for all grades.

Every month shows an ever increasing number of applications for membership and many new members were admitted at the last meeting night. During November, Council and Magazine Committee have met twice in conference to more fully co-ordinate the organisation of activities of the Division and of interesting note to all, to take steps to bring the magazine more into line with the wishes as expressed in many quarters.

The Division have contributed a sum of money to Federal Executive toward the cost of production of certificates to be presented by the W.I.A. for the annual events of the year.

The A.O.C.P. course for non-licencedees, specialised by the Institute, commences on the 15th of January, 1948, and is already rapidly filling with applicants. Those desirous of joining this class would be well advised to direct their enquiries and applications to the Administrative Secretary in time for inclusion.

The first general meeting of the new year will be held as usual on the first Wednesday of the month, 7th January, 1948. Meeting place will be announced from 3WI.

At this meeting it is hoped that more fuller details of the State Convention, already contemplated by Council to be held early in the new year, will be announced.

#### TECHNICAL ADVISORY COMMITTEE T.A.C. Meeting

The Committee discussed alterations and adjustments to VK3WI, and by the time these notes appear, 3WI will have a new antenna, which, it is hoped, will give a greater State coverage. A new modulation transformer will be installed shortly which should help to clear up the quality generally.

#### V.H.F. Group

At the last meeting of this Group, Mr. Glover gave a demonstration of the calibration of Absorption Type Wavemeters for the very high frequencies. The last field day was discussed, and it was decided to hold alternate 50 Mc. and 166 Mc. field days in the future; the next field day to be held on the 7th December on 166 Mc.

#### Receiver Group

Mr. George Neilson will deliver a lecture on the modifications made to the AR7 receiver at the next meeting of this Group. Some interesting points are expected to be brought to light in this lecture, so come along.

#### General Meeting

At the November meeting, Mr. Moriarty, of the P.M.G.'s. Depart. delivered a lecture on Propagation with particular relation to V.H.F. transmissions. The lecture was appreciated by all, in particular the V.H.F. gang, who were given an insight into what effects might be expected when they start to approach the Centimetric wavelengths.

#### "FOOD FOR BRITAIN" APPEAL

Another 25 parcels will have been despatched by the time these notes appear, making the total now 175. The total receipts to the Fund are gradually creeping up and are now £193/9/5, the total expenditure on parcels £159/1/- and the cash in bank £34/8/5.

At the last general meeting, the items to be raffled were 9002, 9003, and 6J6 miniatures and a 455 Kc. crystal, which were won by VK3ZC, Mr. John Tutton. The new Divisional Secretary (Mrs. Cross) made the draw, and the raffle yielded the sum of £10/4/-. The box collection yielded a further £7/16/3, making the total for the night £18/0/3.

Details of a Technical Quiz, to be run in conjunction with the Appeal, are being worked out. The preliminary plans are to arrange for teams of four contestants to meet other teams of four in a series of elimination rounds, winner to compete for a substantial prize. There will be an entrance fee for teams which will all go into the Patriotic Fund for food parcels. This contest will not only stimulate interest in questions on technical subjects but should help the Appeal along. Listen to the weekly broadcasts from 3WI for further details of this Quiz. Think it over, and get your teams ready.

We acknowledge, with thanks, a donation of £2/10/- from the South-Western Zone from surplus funds for the first six months of operation. We also acknowledge, with thanks, the donation of a National Union 807 from W. H. Ross, of Grasmere, for a raffle held at the Annual Dinner.

Send your donations to your Zone Organisers or the Appeal Secretary, VK3UM, who will also receive postal notes for raffle tickets. Your donations, however small, will be gratefully received and faithfully applied.

#### CENTRAL-WESTERN ZONE CONVENTION

What a day, 9.15 a.m. to 3.45 a.m. The Maryborough Convention went very well despite the slip ups. Among those present were VK3s GN, IQ, DP, YW, ATR, XC, AGR, ML, BM, TL, IK, Bill Sawyer, Wally Loveland and Bud Page. Notable vacancies were the Horsham gang; 3AGE had had it so stayed home, 3HL had to stop home and count Callawadda's numberless votes; apologies came in from 3AX, 3EP and 3AKW.

50 Mc. field day, scheduled for the afternoon, was a complete washout for it rained and nobody's gear came up to scratch. However we filled in the time by visiting 3CV where a very interesting time was spent looking over the gear there and admiring the 250 odd ft. top-loaded mast, just the thing to put 50 Mc. beams on. Then back to Maryborough for a visit to 3XC's shack, where a real Ham's dream was on show; little Willie has a simply stupendous Tx there.

After dinner, we adjourned to the

library for the formal part of the programme. Perhaps the most important and informative part of this was the State President's address. 3ML covered a wide spectrum, and left each and everyone of us with the feeling that here at last was the W.I.A. in action. Bob sketched out his ideas for the betterment of the Division, ideas for the betterment of each Zone, ideas and ideals to weld all the more or less disjointed parts into one homogeneous body with one objective and a definite policy to work for in the future.

Members greatly appreciated the President's attendance at Maryborough, and the view was expressed that visits such as his would go a long way towards reducing the feeling of isolation common to many country Hams.

After the meeting, and with the aid of 3ML's Type 3 Mk. II, and 3XC's Amplifier, Bruce Mann (3BM) put on an excellent demonstration of what a c.r.o. will show up on a transmitter. Bruce brought along a tremendous amount of gear and ably and aptly described its construction, function and interpretation. Bruce was warmly thanked for his efforts.

Two of the main decisions possibly were the suggestion to Council to organise a State Convention at a date and place to be fixed, and for the Central Western Zone to hold another Convention before the summer ends.

Note to all Zone Members.—Do not forget Zone Hookup on Sunday, 14th December, 1000 hours, 7050 Kc.

#### NORTH EASTERN ZONE

Zone members are particularly requested to save their pennies and "sevenpences" for a bumper December contribution to R.S.G.B. Appeal. Forward to 3YV, Wangaratta.

3JK is back on 28 Mc. c.w. 3YV on 28 Mc. phone and has renewed schedules with GW3AX who is a very well known South Wales Amateur. New rig at 3YV operating satisfactorily on 7 Mc. and 14 Mc., although not active on 14 Mc. to date. 50 Mc. gear on the way at both 3JK and 3YV.

Regret the possibility of losing Bert (3TM) from our ranks, our loss, somebody else's gain. 3SN is active again on 14 Mc., pleased to hear your old fist again Dud. 3AT on 14 Mc. and quite pleased with renewing W contacts. Using a Franklin oscillator and it works well. 3BP heard on 7 Mc. phone, maybe you will be in the Zone Hookup o.m. Third Sunday in the month at 9 a.m. just as a reminder for all members.

3APB also contacted on 7 Mc. phone and running skeds with 3BP. 3UI reports having erected a Lazy-H antenna for 50 Mc. and now has 24 hour service with 3ABG in Avenel on this band. 3DW and Mrs. Tacey recently completed tour of Eastern Victoria, calling on 3KR, 3YV, 3JK and 3WE. Ted O'Brien and Peter Fawcett, both Shepparton lads, sat for last exam and eagerly awaiting results, best of luck chaps.

Please forward any notes you think may be of interest to reach 3DW not later than the 7th day of each month.

North Eastern Zone members extend the Compliments of the Season to all other Zones and to the Amateur Fraternity generally, and look forward to a progressive 1948.

#### NORTH WESTERN ZONE

3TL and 3BM, Associates Wally Loveland and Bud Page made the 130 mile trip to the Maryborough Convention. Had an f.b. time despite the rain. Must admit however (a) we didn't see much 50 Mc. gear; (b) that familiar voices sometimes issue from mighty strange faces!

3TL has increased his power with a pair of 809s in the p.a. and at same time improved his phone quality. Has built an f.b. indicator for rotary beam. 3OA is working on a 14 Mc. receiver on a No. 11 chassis. 3JG was heard working Yanks on 14 Mc. What say you give us a shout on our 3.5 Mc. hook-up on a Sunday morning Johnny, 3CE, like 3BM, will soon be too busy with a bumper crop to play at Ham Radio. 3BM has erected two more legs to the V beam setup and can now work North, Central and South America and Europe.

Wally Loveland and Bud Page are to be congratulated on their election as Associate Members. Wally is an amplifier fiend an f.b. direct-coupled d.c. job of his design was recently featured in "A.R.W." Bud built a 50 Mc. receiver to take to Maryborough but at the last minute, like everybody else, he left it home. We hope these two keen chaps will soon be ready to try for their tickets.

#### QUEENSLAND

Secretary: R. Thorley, VK4RT, Box 638J, G.P.O., Brisbane.

Meeting Place: State Service Building, Elizabeth Street, City.

Meeting Night: Last Friday in each month.

Seating accommodation was at a premium at the October general meeting of the Queensland Division, the attendance being a record for any post-war meeting. Membership is nearing the 160 mark, which is a most pleasing state of affairs all round.

The Secretary (4RT) gave a full account of the Disposals purchasing activities over the last few months and announced that although many disappointments had been encountered the picture was at last beginning to look a little brighter, and as we write these notes we learn that we have succeeded in acquiring a large quantity of 522 units and also have managed to purchase some 140 Class "C" Wavemeters. These last items will be for sale to members at a sum of 30/-, so if you fellows want a cheap v.f.o. there may still be a few left by the time you read this. Of course you may want one for a frequency meter, for which purpose we believe they are OK by the R.I. Department.

The quantity of 522s is rather considerable, and we have also got kits of spares for same, comprising 4 crystals, sundry plugs and cables.

It is pointed out that in some cases it is not possible to circularise all members with regard to Disposals buys, because of the fact that sometimes cash has to be called for and collected and the transaction finalised before circulars could be prepared. Such instances are in the minority however, and members need not fear that they are missing out on juicy items such as HROs, etc., there just are none to be had!

A few facts on the wallpaper situation. During the six months ended October, cards posted to VK4s intrastate: 414 packets. To interstate and overseas, 295 packets posted; while cards received at Bureau from overseas and VK4s for forwarding number in all 226 packages. For the year to date, cards to VK4s/intrastate, 634 packets. Interstate and overseas 442 packets. Incoming cards from interstate and overseas totalled some 351 packets. Maybe you didn't think there was so much to being QSL Manager, but Eric Neale, 4EN, has handled the job superbly, and it is to try and make his job a little easier that all this is presented. It's all right, we are not finished yet, so read on!

For the department to function smoothly the following duties must be performed: Stamp journal to be kept, postings account and journal, sorting, wrapping, addressing, weighing, stamping and posting. Another point to bear in mind is that the Bureau does not pay postage on cards out-going from the Bureau to YOUR QTH. A free out-going service is available however to all financial members for cards which are being sent away. Cards are posted direct to all countries during the first week of each month, all "W" cards being posted direct to the district managers. Cards for VK2-9 go forward at the discretion of the QSL Officer.

Any QSL card will be forwarded individually under separate cover provided a stamped envelope is provided to cover air or surface postage as desired. Members who cannot get along to meetings should send along stamps to the QSL man occasionally to take care of any cards held for them. Cards WILL NOT be held indefinitely. To conclude, following is a list of VK4s for whom cards are at present held and for whom no stamps are held: VKs 4AE, 4AS, 4AH, 4AG, 4AO, 4BR, 4CO, 4CX, 4CJ, 4CM, 4CS, 4CT, 4FY, 4GH, 4GL, 4GX, 4HH, 4HW, 4HP, 4KK, 4KF, 4KC, 4NW, 4NX, 4NL, 4PC, 4PL, 4RS, 4RG, 4RB, 4SA, 4TB, 4VU, 4VG, 4WB, 4WG, and 4WO. How about it fellows?

It has been a feature of these notes from time to time to appeal for a little dope from country men; and we are happy to say that the gong has at last been rung (come to think of it—do you "ring" a gong?). The joke is

that Fred Lubach (4RF) is the good samaritan, and he is an ex-city man. In a breezy letter he tells of Ham doings in Dalby, the other locals being 4DA, 4XN and 4KZ. DX seems to be quite plentiful up there and Fred enclosed a list a yard long, the top line being fairly representative. FQ3AT, HZ1AB, ET3AF, VO3X, EP1AL and UO5AC. 4XN does a bit on 14 and 28 Mc. and finds time to sandwich a bit of photography in between. 4DA has moved into a house with d.c. only and is installing a rotary converter. 4RF is running 100 watts to an 812 with a v.f.o. using

## Australia's Largest Stock of All Radio Components

Chokes  
Coils  
Condensers  
Dials  
Intermediate Transformers  
Mose Equipment  
Potentiometers  
etc., etc.  
Resistors  
Soldering Irons  
Speakers  
Test Equipment  
Valves  
Pick-Ups  
Power Transformers  
etc., etc.

Obtainable from

### Bloch & Gerber Ltd.

with which is associated  
the

### WELDON ELECTRIC SUPPLY CO.

46-48 YORK STREET,  
SYDNEY

G.P.O. Box 2282 M

Phones: MA 6291 (10 lines)

6SK7, 6SK7, 6F6. The antenna is a 67 feet matched impedance.

The Ipswich men were present in force at the October meeting, and one of the gang, 4WS, recounted his experiences in crystal grinding during the technical discussion which took place. Some of those who had had experience in subjecting crystals to x-rays reported on the great increase in activity as a result of the treatment. The process is restricted to certain cuts however, so there will be no necessity to race off to the nearest x-ray machine.

In the recent disastrous train smash at Tamaree near Gympie, one of those injured was Frank O'Sullivan

(VK4UK) who as a result is an inmate of Gympie Hospital. We do hope that you are out by the time you read this o.m., and wish you a speedy and complete recovery. Following a suggestion by 4RT at the October meeting, a parcel of comforts was dispatched to 4UK. We believe that the local Hams from the surrounding districts have also paid visits to the hospital.

Discussion has taken place of late regarding the formation of a Technical Development Committee, with the object of eventually establishing a permanent headquarters station for this Division, and also establishing a Frequency Measurement Service for the use of members. The present set-up which actually could hardly be bettered is dependent on the generosity and time of a Council member (4FN if it's not known to all) and we cannot impose on Frank indefinitely.

Well, its the end of another year—a year of uninterrupted Hamming—and as is customary at this time of the year it is the wish of the Executive that you all have a very Happy Xmas and all the DX that you could possibly wish for in 1948, and our grateful thanks for your loyal support in 1947.

## SOUTH AUSTRALIA

Secretary: E. A. Barbier, VK5MD,

Box 1234 K, G.P.O., Adelaide.

Meeting Place: 17 Waymouth Street, Adelaide.

Meeting Night: Second Tuesday of each month.

The monthly general meeting of the S.A. Division was held at 17 Waymouth St. on Tuesday, 11th November, when over 110 members and visitors were treated to a first-class lecture by Mr. Murray Higgins (5QM). Among the visitors were Messrs. Laidlaw, Fitzpatrick, Hughes and the Hams included 3GR, 5QI, 5LP, 5TL (Ceduna), 5MN (Snowtown), and 5TR. An apology was received from a YL ships' operator, Klara Eide, of the "Heogh Silver Beam," who had unfortunately left port that day. Ross Harris (5FL), who had returned from Melbourne that day, gave members a short talk on the Disposals gear which may be soon available, and great was the excitement thereof.

Murray Higgins then launched into his lecture on "Audio Frequency Technique," which turned out to be one of the most interesting to date. Murray opened his remarks by gently kidding us that he was just a novice at audio and that we were a lot smarter than he, and so well did he "kid" us up a tree, that when he chopped the said tree down, you could have heard us hit the ground all over Adelaide. A good deal of his lecture was given on the blackboard and the remainder was a practical demonstration of triode versus pentodes and a example of frequency attenuation as applied to amateur transmissions, whilst Murray probably did not tell us anything we

should not have already known, it was surprising just how much he told us that we had forgotten, and he told us in such a way that we soon realised that he knew his "onions."

His changing over from triodes to pentodes and vice versa was so good on speech or music that nobody could pick the change nor whether we were listening to triodes or pentodes, and as I said before the lecture was a huge success, with all present quite enjoying having their legs gently pulled by an expert in that art. A vote of thanks was passed by Dr. Adey (5AJ), who during his remarks mentioned "loop" phone much to the consternation of "Luke" Lucas (5LL) who was once (in the good old days) a staunch supporter of "loop." Fortunately Dr. Adey did not continue for long on "loop" phone and any danger of "Luke" having apoplexy was avoided. By the way, to finish the leg pulling Murray Higgins is only Broadcast Engineer in Charge of Studios for the P.M.G. Is our face red!

In a write up in a local paper our Hon. Secretary ("Doc." Barbier) was described as "bushy browed" which conjures up a picture of a fierce tough guy. Those who know him best were the most amused. There is no truth in the rumour that he is hiring himself out frightening children off to bed, but maybe he would consider an offer from Hollywood as a stand-in for Boris Karloff!

The local s.w.l. gang in VK5 are divided into two camps and both are publishing magazines which reflect the greatest credit to those responsible. I happen to know that several of those who are doing such good work on these magazines are also members of the W.I.A. Pity we can't use them!

Twelve months ago 5PS was given the job of organising a field day. Freshly admitted to Council and eager and enthusiastic, he rushed right out and commenced organising. All he succeeded in doing was falling flat on his "puss" and why? Well 5JE can perhaps tell you now, because he attempted to organise a field day at the last general meeting. Not only did he fall on his "puss," but most of the members walked all over him. You should know by now Ted, that you don't ask for volunteers, you do it all by yourself, lead the members by the hand, both feed and dress them and see that they have a good time, that's what God made Council members for! Anyway you have my sympathy Ted.

I am not usually profane and if the Editor passes this paragraph then I think you will get a laugh. A certain unnamed Amateur was foolish enough to leave his young hopeful alone in his shack with several 807 valves on the table. The youngster knocked them all off the table and smashed them into a thousand pieces. The old man did his block and when the XYL was reproving the lad she said, "I'll bet your Dad said plenty to you." "No," said the lad, "he was

# Low Drift Crystals

FOR  
**AMATEUR  
BANDS**

ACCURACY 0.02% of  
STATED FREQUENCY

3.5 M/C and 7 M/C

Unmounted .. £2 0 0

Mounted .. £2 10 0

12.5 and 14 M/C Funda-  
mental Crystals, "Low  
Drift" Mounted only £5.

Spot Frequency Crystals  
Prices on Application

Regrinds ..... £1 0 0

THESE PRICES DO NOT  
INCLUDE SALES TAX.

## Maxwell Howden

VK3BQ

15 CLAREMONT CRES.,  
CANTERBURY, E.7.

not talking to me he was only talking to Jesus." I crave your pardon fellows, but it made you laugh didn't it? (I hope he didn't have the "mike" open at the time—Editor.)

Thanks to the efforts of 5LW a little more news is available this month, to wit. 5GF is doing a good job with modulation on his baby Type A Mk. III, working all VK on 5 watts. 5LW has restored to its original position his 8 half-waves long wire instead of leaving it mixed up with the Scotch thistles where it has been since the storm of several weeks ago. We will probably hear DX tacked on to the famous CQ now. Talking of the storm, 5TR lost his feedline to his 2 element rotary beam which has been doing good work on DX phone.

5AK contacted KH1FQ on phone, using 10 watts and the QSO was 100 per cent. both ways. Who wants QRO? 5HR is changing from cathode modulation to 6L6s class AB<sub>1</sub> and it is now being hooked to the final. No more will the grape vines thrive on the 5GL r.f. as the new 28 Mc. beam is almost in the sky, a slight delay being caused by pipe shortage. 5YQ is back on the air again after taking the count with a week's illness. He is using a Type 3 Mk. II whilst rebuilding a bigger rig.

5BY also hitting the high spots, with 20 watts to his Type 3 Mk. II contacting OK2DD, G3FS, F8MI, F9DZ, HK1FU, KM6AB and MD5PC. 5VO is active on 7 Mc. and has a f.b. signal from a single 6V6. 5EZ absent with flu from general meeting, but

OK now. 5GD also absent but so far have not heard why.

It's been often told that telephones destroy the personality of one's voice, of course that is when one has the so called personality, but when one is so often mistaken for the office boy—or was it girl—one can easily understand just where the name "Pansy" comes into the picture. (I'll bet 5PS will have a fit when he reads this—Editor.)

By the time you read these notes it will be Xmas so I will take the opportunity of wishing you all the Compliments of the Season and may the New Year bring you all you wish yourself and don't forget fellows, I don't mind how many of you have a "shot" at me, its all news! which helps to push this great hobby of ours along.

#### NORTHERN TERRITORY NOTES.

Activity is not very great amongst the chaps. due to different technical troubles, etc.

VK5AE (Dave Medley, ex-VK3MJ) is active on 28 Mc. with low power rig and four element beam. Quality is not the best and trees around the beam screens it quite a lot. Dave has found he can work DX and believe he has the bug. No sign of getting on 50 Mc. yet.

Noel, VK5NR, is QRL working on a super pro receiver. A recent Disposals purchase. — VK5SA started off in c.w. contest but gave it away. QRM and poor conditions were no enjoyment. — VK5QV is inactive due to transmitter trouble.

He tried taking a few plates out of doubler tank condenser, result was no capacity at all. — VK5AE shifted QTH to Katherine and hopes to be active from there. — VK5AY (Bruce Aubrey) has been very quiet, maybe trying to find the reason for the handsaw note.

VK5KL has a three element beam, T-match to a Amphenol 300 twin lead. No trouble to raise the DX now on 28 Mc. Still watching 50 Mc. for an opening. Believe missed a chance on 12th and 13th October in the afternoons. NPM commercial in Hawaii was audible and harmonic of c.w./b.c. station, also another commercial. Has received QSL from WTACS/KH6 re his 50 Mc. contact. — VK5AV bought a lot of gear at Disposal sale. No signs of getting back on air yet. — VK5CN, nil heard of but possibly the skip on 14 Mc. prevents it.

#### WESTERN AUSTRALIA

Hon. Secretary: W. E. Coxon, VK6AG, Howard St., Perth, W.A.  
Meeting Place: Builders' Exchange, St. George's Terrace, Perth.  
Meeting Night: Second Monday in each month.

A large attendance filled the meeting place on the 10th November, 6GM presided, keeping the business brisk and to a minimum, leaving the majority of the evening for instructive entertainment.

A sound film lent by the Department of the Army, on "Frequency Modulation," kept the audience very

## RED LINE EQUIPMENT FOR THE AMATEUR

### INCLUDES:

- High Tension Plate Transformers
- Low Tension Filament Supplies\*
- Class B Driver Transformers
- Multi Impedance Modulation Transformers
- Heavy Duty Power Supplies
- Swinging and Smoothing Chokes
- Wide Range Audio Equipment
- Frequency Dividing Networks

\* Insulated up to 4000 volts if required

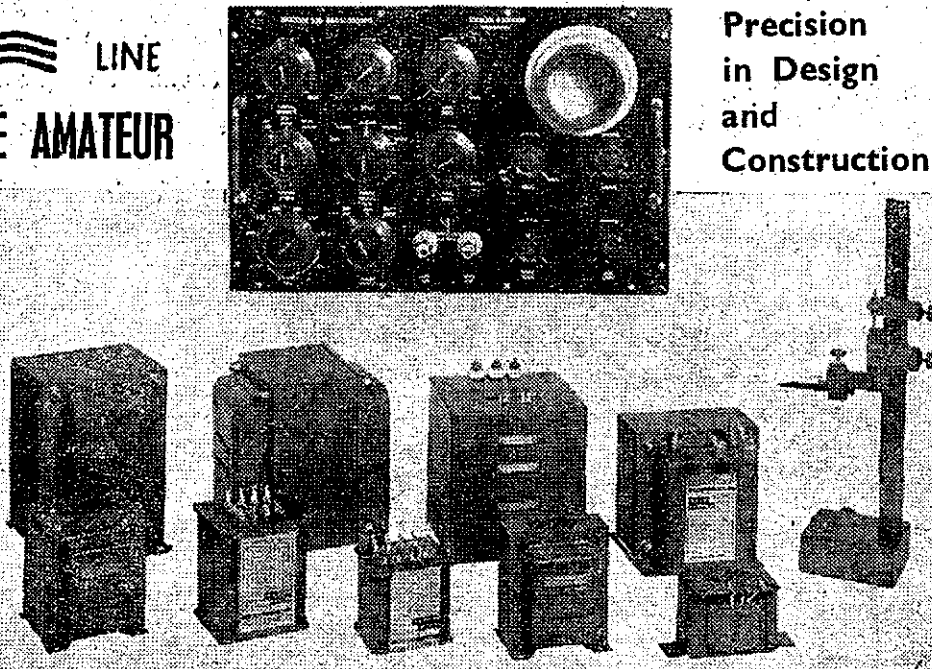

Precision  
in Design  
and  
Construction

#### Workshops:

2 Coates Lane,  
Melbourne.  
Gen. 4773.

## Red Line Equipment Pty. Ltd.

Incorporating SWALES & SWANN

#### City Office:

157 Elizabeth St.  
MU 6895



# 16 SWAN STREET, RICHMOND

AMATEURS AND RADIO EXPERIMENTERS, SEE US FOR ALL YOUR RADIO REQUIREMENTS.

WE HAVE A VERY LARGE AND EXTENSIVE RANGE OF SHORT WAVE EQUIPMENT. A NEW SHIPMENT JUST ARRIVED. ALSO LARGE CONSIGNMENT OF VALVES OF ALL TYPES, including:—807, 6J7, 6V6, 6B8, 6U7, 6K8, 6J8, 6SH7, 6AC7, 9002, 9003, 954, 955, 956, 5V4, 5YB, 6X5, VR105, VR150, 9072, 1603, 879. ALL TYPES OF 2-VOLTS AND 1.4 SERIES. SPECIAL DISCOUNT GIVEN TO HAMS.

## COMPARE OUR PRICES

**COMMUNICATIONS RECEIVERS** include:—The A.W.A. Type, AR8 Receivers, All Wave, 6 Band, B.F.O., works off A.C. or D.C. 12 Valve, 6.5 Volt series. Band coverage, 20 Meg. to 140 K.C. Excellent set for all purposes. With Power Supply, £25; less Power Supply, £15.

**AMERICAN R.C.A.** 8-valve Receiver, model DZ2. Covers broadcast and long-wave frequency. 750 K.C. to 32.5 K.C. Less Power Supply. Sacrifice at £25.

**HIGH FREQUENCY RECEIVERS.** Types AR301 and 46AAT. Covering 2½-6 metres. Valve line-up, 5 tubes, 955-956. Mixer stage—4-6 A.C., 7's, I.F. Stage, 2 Meg., 5V4. Rectifier. Power Supply, &c. A gift at each £15

**MARCONI TRANSMITTER.** Type T1154. Phone or C.W. Preselector Band Switching. As new. Less Power Supply £17/10/0

**RAC AR 12** 7-valve Communication. 4 Band. RF gain control. Xtal gate, BFO, &c. Battery operated. Sacrifice £25

**COILS, plug-in type, for Australia and English AR14** Receivers. 25/- box or 1/6 each. Order now while supplies available.

**VALVES.**—We have large quantity of all types of Valves. Transmitting and Receiving.

**TELEPHONE SWITCHBOARDS.** 10 line. Good order, from £3 to £12 each. The Units have many uses on farms, &c.

**WAVE METERS, CLASS C, AUSTRALIAN A.W.A.,** vibrator operated. Complete with Spare Vibrator. To clear £5 each

**CRYSTAL CALIBRATORS.**—We have in stock limited number of Crystal Calibrators, harmonic freq. range 1000, 100, 50 K.C. Vibrator operated, 6-volt. To clear £15

**OSCILLATOR.** 75 meg., complete with output meter, vrey elaborate, 230 A.C. operated £25

**HIGH-FREQ. TRANSMITTERS and OSCILLATORS.** We have in stock several of these units, which may be useful to high-freq. experiments. Also have a quantity of incomplete units for wrecking purposes.

**AMERICAN TRANSMITTERS.**—20-watt Plug-in bond type, CBY 52063A. Phone or C.W. valve line-up, 2 89's into 2 837's. RF meter, &c. Limited quantity only £20

**REMOTE CONTROL UNITS,** complete with mic. and phones. Morse key. Can be used for house phones, &c. Condition as new. To clear £1 each Order now.

**EARPHONES.**—Several types, including crystal, moving coil, magnetic. U.S.A. Navy types, with large ear pads. 35/- to £3 per pair Limited quantity only.

**TRANSCEIVERS,** 109's, S.T.C., 9 Valves, covers 80-metre band. Tube line of Receiver, 6U7's, 6K8's, 6B6's. Transmitter, 3-807's. Receivers easily convertible for local reception, 6-volt vibrator operated. Price £12/10/0

**TRANSMITTERS.**—Famous A.T.5 50-watt, phone or C.W. Xtal or V.M.O. Tube line-up Occ. 6V6, Doubler 807, 2-807 in parallel in final. Band coverage 500 K.C.-15 Mc. Meter covers all stages. Input 12-volt A.C. or D.C. H.T.500-V-300. Generator supplied with unit, or A.C. Transformers and chassis supplied. Also Aerial Coupling Unit Price £25

**TRANSMITTERS.** 3B.Z. A.W.A. Xtal controlled, 6 holders, band coverage 3.5 Mc. and 7 Mc. Tubes used, 4.6V6's-1-807, Vibrator operated off 12-volt battery. Meter for all stages. This set operates on phone of C.W. Price £17/10/0

**TRANSMITTER.** American type, BC-191-E, 100-watt, phone or C.W. Precision built. Plug-in band change coils. Very elaborate power supply, adjustable filament and H. tension voltages, circuit breakers, relays, &c. A beautiful job: a welcome addition to any ham shack. Price £75

**METERS.**—All types. R.F. Thermo Couplo, 0 to 1 A.M.P., 15/- D.C. Milliampere 0 to 300 Mill., 15/-

**FILTER CHOKES AND CONDENSERS, RESISTORS, VARIABLE AND FIXED.**

Inspect all these items at

## SPARE PARTS

16 Swan Street . . . Richmond

Phone: JA 2827

After Hours: Haw. 4465

SPECIAL ATTENTION GIVEN TO COUNTRY MAIL ORDERS.

attentive. F.M. is considered by many as a difficult subject to approach and describe, but we have no hesitation in applauding this particular film. Many VK6s went home with a much clearer picture in their minds, of f.m. than they had previously. A vote of thanks was passed to 6OR for his efforts in arranging the loan of projector and film from the Army.

New members: VKs 6JW, 6AY, 6XG, 6AF, 6WP, 6TP. These bring our membership to 83% of the total licenced Amateurs in VK6 today.

### PERSONALITIES

6LM getting RA-10-FA going with false front panel on side, and running controls in through common plug hole. —...— 6CP has a Bendix and should be on the air shortly, just waiting for the driver unit. Clarrio is building a 50 and 28 Mc. converter too. —...— 6FD is using his Bendix Rx and Tx. —...— 6WT was pleased to introduce 3TZ to 7GR last month. A very f.b. 4-way QSO resulted with 6AH, 3TZ, 7GR on 7 Mc.

6AH works all the DX on 7 Mc. W, PK, ZS, VU, VS7 and VS2 being only some of the f.b. contacts made. —...— 6WS is getting about the country with his small ex-Army Transceiver. Heard working 6AH, 6FD and Perth from Boyup Brook. —...— 6NL is a real v.f.o. man now. Vic discovered that "not all works well that looks well." At any rate he has the "darn thing" working OK now.

6TX on the air at last. Jack has a new rig and is to be heard on 7 Mc. —...— 6DF is a No. 19 fan. A really f.b. portable is now owned and operated by Maurice from the well known V8. A trip to Merredin proved what these versatile outfits will do. —...— 6JS heard regularly now on 14 and 7 Mc. Ask him how to erect long wire antennae. Flying kites is a bit hard for the grown-up, isn't it Jack?

—...— 6AP increasing power to 100 watts. With the new rotary beam Alf is going places. —...— We believe 6WZ knows quite a bit about the doings of the Geraldton Hams. How about letting "A.R." into it o.m.? Contributions can be sent to 6KW before the 10th of the month.

6EL still looking for his W.A.C. Those elusive South Americans don't seem to come Ern's way. Never mind o.m. they will appear when you least expect them. —...— 6KW is rebuilding his beam. Rumour has it that he is going to build a 50 Mc. array. —...— 6RU has well passed the century in countries worked post-war. Jim's trouble now comes—getting the cards. —...— 6FL not heard so much lately. Frank has evidently some more irons in the fire. What's on o.m.? —...— 6HT is another country Ham who we feel sure could help "A.R." along with some local notes. How about it Harry? —...— A consistent G schedule on 28 Mc. is held by 6HL with G5OV. Cecil on

the other hand works VK6 every day.

6AG was heard giving the W.I.A. local broadcasts on Sunday mornings last month, during the temporary absence in the country by 6WH. —...— 6FW is now in chains. Not bad bonds though as they are held by the XYL. Yes he went and done it. Congrats o.m. —...— Between furniture making 6HS is heard on 14 Mc. Makes some good DX contacts too. —...— 6MU is a well known Merredin Ham who has done some good work for the W.I.A. How about some notes for "A.R." Mal? Let's know the Merredin doings. —...— 6MY pops up on 14 or 7 Mc. when we least expect him. Not a DX hound—yet. —...— We all feel sure that 6DX could complete our country notes for "Amateur Radio," and let us into the secrets of the Goldfields. What say Bill o.m.?

### DX OF THE MONTH

The annual DX contest, sponsored by the W.I.A., is once again over (thank heaven) and although conditions could have been far better, some of the DX was very tasty both on 28 and 14 Mc.

As seen in a previous issue of this magazine, the rules provided for phone operation over the first two week-ends of October and c.w. operation over the last two and these notes cover the phone section.

The score at the end of the two week-ends stood at 49,980 and made up of 238 QSOs in 70 countries on 28 and 14 Mc.

28 Mc. Phone, Europe.—This continent provided the bulk of the contest contacts on this band. The Gs being too numerous to mention. GM8NW, 2IQ, Scotland; GW3UO Wales; PA0ALO, QFB, QOD, QNG, OQJ, OAN, Holland; QZ3HR, 9Q, Denmark; EI3J, Eire; LX1JW, 1SI, Luxemburg; D4APN, 4ACD, Germany; HB9ET, Switzerland; SM5RF, Sweden; I1XX, 1MH, Italy; OH2SE, Finland; OK1JB, Czechoslovakia; ON4WS, Belgium, were all short but 100% QSOs.

Africa.—The Union boys were all there calling CQ-VK, and among those worked were ZS6EG, 6IW, 6NE, 5U, 5DA, 5BS, 6FD, 5BR, 5FJ, 6JB, 1AX, 6EU, 6BW, 6LF (and we could keep going for a few more lines); VQ4ERR, Kenya Colony; MD5TS, 5AF, SU1WS, Egypt; ZS6OL, Buchuanaland; VQ3PYE, 3EDD, Tanganyika; ZE2JA, Southern Rhodesia; OQ5BA, Belgian Congo; ZS4P, Basutoland.

North America.—Strange as it may seem, the Ws did not break through in the numbers expected, and altogether less than 20 were worked. VE7EL had a terrific signal and provided the only Canadian contact. KL7KB, Alaska, was the only other QSO. A nice catch the other evening was VO2Z, Newfoundland, who was

worked across Europe, but not in the contest—sad luck!

Central America.—Only a few QSOs resulted from this area, i.e. XE1A, 1FE, Mexico, and KZ5AZ in the Canal Zone of Panama.

South America.—The chaps heard from this continent were HKs, but time did not permit the usual chasing. HK3AB, Colombia, was the only QSO.

Oceania.—This area came good with numerous contacts from Hawaii to the Phillipines, although the ZLs were absent in numbers as only one was worked. KM6AV, Midway Islands; KG6BT, Guam; KH6LD, 6BI, 6DF, Hawaii; KG6AW/VK9, Admiralty Islands; KA1CB, Phillipines, and numerous PKs all provided extra points.

Asia.—When one wants to work Js, etc., the devils just won't come back, and the response from the Northern Pacific Islands was very poor. J8AFK, Korea; J9AGT, 9AAS, Okinawa; C1CH, China; XZ2YT, 2DN, Burma; VS1BJ, 2BU, Malaya; PK1RK, Java; VU7JU, 7AB, Bahrein Is.; CR9AM, Macao, were some of those worked.

14 Mc. Phone.—The best time on this band was from early Saturday morning (0100) onward, until daylight, with the beam on Europe.

Europe.—Most QSOs were with Gs, the best being G5VM, 8PD, 6WX, 8QX, 6XR, 5OV, 3DO, 2UZ, GM2UU, Scotland; PA0GN, OFB, Holland; ON4VK, Belgium; D4AUG, 2KW, Germany; F9BE, 9DH, France; OZ9Q, Denmark; SV1WE, Greece; HB9FU, 9ET, Switzerland; I1AKF, Italy; EI3J, Eire. All good multipliers.

Africa.—Quite a few of the gang from last year's contest came to light from the Union. ZS5M and 6CT were two in particular, while from farther north came VQ4NSH, Kenya Colony, at 6.30 a.m.; ZE2JG, 2JO, Southern Rhodesia; MD5AB, Suez Canal Zone.

North America.—Ws have been quite plentiful during the evenings and one QSO was made in the early morning across South Africa which shows that last summer's early morning QSOs are not far off. VE4IF, 3HC, 3ACO, from Canada, were good point "getters."

Central America.—XE1A, Mexico, VP9F, Bermuda, at 0430 Saturday morning across Europe and HH2CW, Haiti, were the only three from this area.

South America.—The most consistent South American to be heard here, HK1FQ, Barranquilla, Colombia, has been worked quite a few times now from this State.

Asia.—ZC6JL, Palestine, was a good catch one morning about 0700; VS7JB, 7IT, Ceylon; VUs from India in droves and quite a number of Js, VVs, Cs, etc., which were all welcome from the "points" point of view.

# A.G. HEALING

LIMITED

MANUFACTURERS AND  
DISTRIBUTORS FOR . . . . .

Electrical and Testing Instruments for all purposes made to British Standard specifications. Each instrument is accurate, + or -, to 2 per cent., and parts are heavily plated to prevent corrosion even under tropical conditions. "Healing" Electrical Meters equal the best imported types and will give accurate service for long periods under the most exacting conditions.

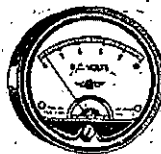

No. 10A round production mounting Black Bakelite Case.

Type No. 30A 4" square semi-flush Black Bakelite Case.

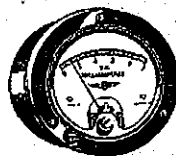
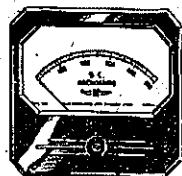

No. 20A 2½" round flush mounting Black Bakelite Case.

These, and all other Healing Radio Electrical Testing Units, are manufactured in our own factories and available from A. G. Healing Ltd.

OTHER INSTRUMENTS INCLUDE:

Oscillators — Multi-Testers — Signal Tracers, etc.



ALSO MANUFACTURERS AND DISTRIBUTORS FOR

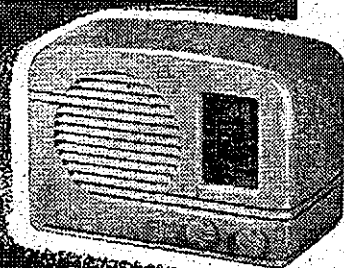

## Golden Voice RADIO

A. G. HEALING LTD., Melbourne, Sydney, Adelaide  
WESTERN AUSTRALIAN DISTRIBUTOR: Cloak's Household  
Utilities, 858 High Street, Perth. BRISBANE REPRESENTATIVE:  
H. K. Lane, Basement, A.M.P. Building, Queen Street, Brisbane.  
TASMANIAN REPRESENTATIVE: G. J. Irvine, P.O. Box 375,  
Launceston.

H.F.P.

# TASMANIA

Secretary: J. Brown, VK7BJ  
 12 Thirza Street, New Town.  
 Phone W 1328.  
 Meeting Place: Photographic Society's Rooms, 163 Liverpool Street, Hobart.  
 Meeting Night: First Wednesday of each month.

Thirty-seven at the November meeting and still they roll in. Half an hour before proceedings opened, 7LJ cranked up the buzzer with some good old fashioned morse practice for the benefit of the rising generation and for not a few of us who could do with some, anyway.

After the minutes were read, announcement was made of the new Advisory Committee: 7XA, 7CT, 7ML, 7EJ, 7NL and 7RF.

Progress of the Food-for-Britain Fund, which is now £58 to the good, was reported by 7XA, who has to hand a letter of appreciation from the R.S.G.B. We are hoping the various difficulties of getting the food over there will shortly permit us to earn the appreciation.

Further news of the Tourist Bureau's QSL cards is rather scarce at the moment, but it is understood that the submitted design is under consideration by them.

A D/F field day was fixed for Sunday 23rd. Again it is to be a place within 15 miles radius of Hobart G.P.O., but, as nearly everyone seems to get there by some means or other, a points system is to be tried out this time with a view to reducing the importance of horsepower and encouraging accuracy (my 8 small horses will appreciate the first item!). Points are to be allotted on a basis of mileage multiplied by five plus time in minutes, and the lowest number wins. 7KA takes the transmitter. He has been muttering darkly about coal mines and badger traps, so there is likely to be some hard work done that day.

7YY gave an account of his recent week-end in Launceston, where a couple of the lads still seem to be in the doghouse for their long hours spent in the DX contest. 7AB and 7XL were down from the northwest, and visits were paid to 7LZ, 7BQ and 7RK. Very enjoyable, too.

Lecturer was 7TR, who gave an interesting talk on his adventures with modulators and Franklin oscillators.

## NORTHERN ZONE

The event of the month was, of course, the DX contest and it was pleasing to hear the VK7s working the c.w. section. In this Zone 7RK, 7DS and 7LZ were the only stations participating and their activities were confined mainly to "normal" hours. We however gave the DX stations a chance for the additional multiplier—what's more we kept Tasmania on the map. Lou (7LJ) was heard in

Launceston quite a few times at S5 during the test.

7AB, 7XL and 7YY were all in Launceston for the November long week-end holiday and on the Sunday morning an informal gathering took place in 7BQ's shack. 7AB had his 50 Mc. converter with him. This was extremely interesting to 7BQ and 7LZ. 50 Mc. was the main topic of conversation. 7YY, 7BQ, and 7LZ afterwards called on 7RK.

Mr. P. Dunne (our newly appointed Superintendent of Wireless) and Mr. C. Carroll, the R.I., paid a visit to the North and found time to meet 7BQ and 7LZ. It is certainly gratifying to see the interest taken in Amateur Radio by these two officers.

As an item of interest for those stations who were QSOing the Friendly Islands, VR5IP advises that both he and VR5PL are one hundred per cent. QSL, however they are at present temporarily out of cards and are awaiting new supplies from the U.S.A.

VK3ACR, ex-7KR, is at present in Launceston. Charlie is still as keen as ever and is doing the rounds of the shacks. Owing to the contest I have very little station activity to report.

7DS worked his first 28 Mc. DX. It was certainly Hugh's big moment. . . . 7RK found some good DX and quite a few new countries, that was Ray's main reason for sticking to the contest as he did. . . . 7BQ also had a lucky break when he contacted XE1A on 7 Mc. phone for a one hundred per cent QSO.

7JW has not been seen by any of the Launceston gang since he resumed activities, however he is working quite a few VKs on 7 Mc. phone judging by the stations heard calling him. . . . 7LZ has also had rather a quiet month, but was fortunate enough to log a couple of decent contacts in the test. Even tried 3.5 Mc. with XE1A, but without success.

## A.O.C.P. CLASS

The Victorian Division A.O.C.P. Class will commence on 15th January, 1948. Lectures are held on Monday and Thursday evenings 8-10 p.m. Persons desirous of being enrolled should communicate with the Secretary Box 2611W, G.P.O., Melbourne; Phone FJ 6997 from 9 to 5, or the Class Manager on either of the above evenings.

# AMATEUR CALL SIGNS

All Call Signs that have been published in "A.R." are supplementary to the July, 1947, P.M.G.'s Call Book.

## Aterations

- VK2AFP—R. L. C. Cream, c/o C.R.O.C. Substation, Elangowan Rd., via Casino, N.S.W.
- VR2AEN—G. C. Morrison, 43 Brabyn St., North Parramatta.
- VK2AZ—E. L. Day, 105 Victoria Rd., Drummond, N.S.W.
- VK2EH—E. P. Hodgkins, 28 Brookong Ave., South Wagga, N.S.W.
- VK2ET—W. R. Beveridge, 74 Epping Ave., Epping, N.S.W.
- VK2PV—J. P. Vesper, 30 Bradley's Head Rd., Mosman, N.S.W.
- VK2SL—R. J. Scholtz, 49 Wallis Ave., Strathfield, N.S.W.
- VR2YT—G. R. Woodward, 304 Stewart St., Bathurst, N.S.W.
- VK2ZN—J. W. M. Cottrell, c/o Radio Centre, Carlingford.
- VK3ADJ—D. J. Barkin, 77 High St., Prshran, Vic.
- VK3AIG—I. G. Gillies, 51 Denham St., Hawthorn, E.2.
- VE3AJH—J. R. Handley, 84 Neville St., Albert Park.
- VK3AKL—K. S. Hunt, 69 Riviera St., Mentone.
- VK3MK—N. D. McKenzie, Smith St., Warragul.
- VK3QY—C. W. Richardson, Edward St., Cheltenham.
- VK3RE—W. J. Hehir, Kent Rd., Hamilton.
- VK3XH—C. A. Hyatt, 30 View St., Alphington.
- VK3ZM—H. D. Nihill, 6 Gower St., Kensington, W.1.
- VK4FJ—S. R. Baxter, 151 Jackson's Estate, Gribb Island, Brisbane, Qld.
- VK4WR—W. E. Hagarty, 13 Sponing St., Hermit Park, Townsville.
- VK5BU—F. P. Bourne, 52 Cambridge Terrace, Malvern, S.A.
- VK5HT—H. J. Townsend, 25 Glösse Ave., North Glenelg, S.A.
- VK5KJ—G. W. Cannon, c/o Flying Doctor Base, Alice Springs, N.T.
- VK5RS—R. S. Edgar, Moorhead Ave., Springbank, S.A.
- VR5XY—W. N. Hart, 19 Fisher St., Fullarton, S.A.
- VK6RG—A. J. Piggford, 17 Boreham St., Cottesloe, W.A.
- VK6RI—J. S. Choate, 228 Hensman Rd., Subiaco.
- VK9AI—B. E. Mathieson, c/o O.T.C. Radio Station, Port Moresby, New Guinea.
- VR2SS—new VR2SS—A. Skene-Smith, Port Moresby, New Guinea.

## Cancellations

- VK2XX—B. Dale, 12 Laybeck St., Penshurst, N.S.W.
- VK4RU—R. A. J. Taylor, Nelson St., Mackay, Qland.
- VK6WU—W. G. Brett, 59 Osmond Terrace, Norwood, S.A.
- VK6DO—I. M. Hobbs, 58 Mitchell St., Merredin, W.A.

## New Issues

- VK2AEM—E. J. Mutch, 25 Elizabeth Bay Rd., Sydney.
- VK2AGB—G. H. Bamford, 79 Consett St., Concord West, Sydney.
- VK2AGC—G. Books, Bywong, Sutton, N.S.W.
- VK2AIX—G. A. Wood, 31 Ruthven St., Bondi Junction, Sydney, N.S.W.
- VK2AJN—J. B. Jarman, 38 City Rd., Chippendale, N.S.W.
- VK2APR—Mrs. J. F. Taylor, 11 March St., Richmond, N.S.W.
- VK2AUG—A. E. C. Cooper, c/o A. J. Cooper Pty. Ltd., 2 Quay St., Sydney (station portable on Yacht "Asgard").
- VK2FF—L. C. Bracken, 71 Macpherson St., Mosman, N.S.W.
- VK2MA—A. N. Lansley, 2 Jersey St., Enfield, N.S.W.
- VK2MB—H. J. Banks, 229 Bronte Rd., Waverley.
- VR2PC—G. N. Parkinson, 86 Sydenham Rd., Marrickville.
- VK2QC—J. L. Carter, 182 Madeline St., Belmore.
- VK2QV—R. L. Leask, 85 Trafalgar St., Belmore.
- VR2RS—R. Q. Rawnsley, 1 Fremont St., Concord West.

Amateur Television .... Sept., page 5  
 Australian DX Century Club ..... Aug., page 9  
 Broadcast Interference from Amateur Stations from Amateur Stations Jan., page 5  
 Call Signs and Countries, List of ..... Nov., page 3  
 Cathode Ray Modulation Checker, A ..... Mar., page 5  
 Clearing the Ether, Part VIII ..... Feb., page 3  
 Clearing the Ether, Part IX ..... April, page 4  
 Clearing the Ether, Part X ..... June, page 5  
 Clearing the Ether, Part XI ..... Sept., page 3  
 Crystal Filter, A Wide Range ..... Oct., page 6  
 Crystal Filter, The ..... Oct., page 3  
 Decibel, The Story of .... April, page 8  
 Direct Disc Recording .... Mar., page 3  
 DX Book-keeping .... July, page 6  
 Filament Circuit for D.C. Areas ..... Jan., page 6  
 Folded Dipole, The ..... Feb., page 5  
 Folded Dipole, Unfolding of ..... May, page 3  
 Folded Dipole, Current Distribution and Impedance Ratios of .... May, page 5  
 From Junk Box to 166 Megs. .... Jan., page 4  
 Frequency Modulation, Part I ..... Nov., page 3  
 Frequency Modulation, Part II ..... Dec., page 6  
 Indicating Meters, Care of ..... Sept., page 27  
 Six Element Rotary Beam for 166 Mc. .... July, page 3  
 Taming an 807 .... Mar., page 23  
 Telegraph Manipulating Key Design ..... Aug., page 24  
 Terrific Two Watter, The Jan., page 3  
 Type 3 Mark II, Modification of ..... Dec., page 3  
 Unirad Co-Axial Cable Specifications ..... April, page 9  
 V.H.F. Antenna ..... April, page 3  
 V.H.F. Receiver Design .. June, page 3  
 Variable Frequency Oscillator, A ..... Aug., page 3  
 Victorian Zones, Map of July, page 23  
 W.A.Z. Zone Boundaries Mar., page 9

scouraged by so merciless an activity as Amateur Radio.

We need all the vigor, all the optimism, all the hope and all the grit we can muster up to strengthen us, to wash those DISHES.

When you are despondent and discouraged, play the game, no tyranny of circumstances can permanently imprison you in the pantry. Play the game with the cards you have, don't ask for a new deal; Listen Mum, DX—no stove!

**Modification of Type 3, Mark II**

(Continued from page 6)

attached to plug from which existing lead was removed). Second set of contacts short circuit relay winding.

Up position of key switch:— (PHONE) First set of contacts performs same function as first set in down position. Second set of contacts short circuits signaling key.

(2) Relay of telephone type with suitable winding and three sets of contacts. The winding is arranged in series with 500 v. h.t. lead to Type 3 Transmitter, and the relay therefore operates when anode current flows. The first set of contacts is specially insulated and normally closed, short circuiting the secondary of modulation transformer which is also connected in series with 500 v. lead to Type 3.

The second set of contacts, also specially insulated, is of change over type, and switch h.t. from the receiver to the modulator. The receiver being connected when relay is not operated.

The third set of contacts operate pilot lamp to show when relay is operated.

**FOR SALE, EXCHANGE, WANTED**

9d. per line, minimum 2/-

THREE Stage Transmitter comprising 837 dblr., 837 buf., and Eimac 35TG final stage. Capable of 100 watts input on 7, 14 and 28 Mc. Using Eddystone and Hammarlund tuning condensers with h.v. split-stator Hammarlund condenser in final. Built in enclosed metal cabinet 32" high, 15" wide and 10" deep. Includes 4" 0/250 Ma. meter. Including power and bias supplies, but not including oscillator stage. Price £24. Also 803 r.f. pentodes (new) £2 each; pair of 305 R.C.A. class B triodes £1 each; and 4242, 50 watt triodes, 15/- each. Write: D. C. McDonald, VK3DM, 16 Railway Avenue, Malvern, Victoria, or Phone MW 9654.

- VK2ZU—N. S. Gilmour, 12 The Grove, Moaman.
  - VK2ZZ—W. R. Clarke, 34 Redan St., Moaman.
  - VK3ACD—A. Campbell-Drury, Heard Island (Antarctic Expedition).
  - VK3AEF—H. R. Fitzsimmons, 26 Frederick St., Horsham (portable).
  - VK3ARG—K. G. Horne, 13 Lava St., Warrambool, Vic.
  - VK3AMG—G. S. Compton, Heard Island (Antarctic Expedition).
  - VK3ANL—E. L. Blackmore, 26 Mayston St., Hawthorn.
  - VK3APA—H. C. Parker, Staff Quarters, Fiskville, via Ballan.
  - VK3AV—J. L. A. Martin, 11 Pynsent St., Horsham.
  - VK3ME—A. Stuart, 57 The Boulevard, Hawthorn.
  - VK3OY—L. E. Macey, Heard Island (Antarctic Expedition. Home Address: 17 Nathan St., Coogee, N.S.W.)
  - VK3PE—R. T. Pettigrew, 2 Donne St., West Coburg.
  - VK3QL—S. H. Le Breton, 22 Hargraves St., Mornington.
  - VK3QQ—J. R. Lancaster, 6 Darling St., Hughesdale.
  - VK3TG—F. H. Taylor, Turner Rd., Highett.
  - VK3UE—S. H. Adams, 7 Wellman St., Box Hill, E.11 (portable).
  - VK3US—Mrs. G. M. Churchward, "Shirley," Red Hill.
  - VK3ZF—G. G. Coventry, 7 Tanner Gye., Northcote, N.G.
  - VK4AE—A. L. Smith, Macdonell St., Toowong, Q'land.
  - VK4BL—A. H. Hinkler, Crosby Rd., Albion (portable in Kingaroy-Wooroolin areas).
  - VK4GA—G. A. Shearer, Hunter St., Rockhampton.
  - VK4ML—L. L. G. Meek, Flat 39/5, Qld. Temporary Housing, Rocklea, Brisbane.
  - VK5BP—W. M. Rice, Amanda St., Murray Bridge, S.A.
  - VK5KB—P. H. Syme, 17 Northgate St., Unley Park.
  - VK5KE—J. P. Rosevear, 103 David Terrace, Kilkenny.
  - VK5TT—Thebarton Boys' Technical School, Ashley St., Thebarton.
  - VK5WH—Woodville High School, Woodville, S.A.
  - VK6AY—A. V. Tresidder, 47 The Avenue, Nedlands, W.A.
  - VK6LA—L. C. Allen, 24 Commonwealth Ave., North Perth.
  - VK6LB—L. S. Blackman, 5 Farmer St., North Perth.
  - VK6MX—M. S. Lacy, 74 Highway, Nedlands.
  - VK6MZ—F. T. Marjure, Jindong, via Busselton, W.A.
  - VK6ND—N. H. Dawson, 397 Charles St., North Perth.
  - VK6QP—Q. J. Foster, 15 Waverley St., South Perth.
  - VK7AE—G. Major, Macquarie Island (Antarctic Expedition).
  - VK7CF—C. J. Frisby, Lako Margaret Power Station, via Queenstown, Tas.
  - VK7LS—L. S. Eddington, 18 King St., Sandy Bay, Hobart, Tas.
  - VK7MK—M. H. Roglin, 65 Davey St., Hobart.
  - VK9BP—B. P. O'Connor, Dept. Civil Aviation, Govt. Aerodrome, Lac. New Guinea.
- All above calls are complete up to the 14th November, 1947.

**DON'T "LEAVE THE DISHES IN THE SINK"**

Every man who starts in the Amateur game sets his sails to an untried breeze. He is the first man to ever burst into the maelstrom.

After twenty-one years, the fight for the ideal winter-spring operating position (along-side the kitchen stove) has become intense; the fighters are treading on each other's toes; woe to him who stops to tie his shoe strings.

Never before were men devoured by so insatiable an ambition, or

AMATEUR BROADCASTERS...

... You're Looking for the  
FINEST RANGE OF

**\*Radio Parts**



There are none better than  
those that come from

## LAWRENCE & HANSON

Regular suppliers of radio parts and components for many years, Lawrence & Hanson present to the Amateur broadcaster of Australia the MOST COMPREHENSIVE RANGE of Radio Parts PROCURABLE ANYWHERE!

Moreover, L. & H. parts are GUARANTEED to give years of excellent service, because they are made from the finest quality materials and backed by sound electrical engineering knowledge.

Obtain lists and prices from your radio house.

Technical Advice given on request.

**LAWRENCE & HANSON**  
**ELECTRICAL PTY. LTD.**

33 York Street, Sydney. 172 William Street, Melbourne. 120 Collins Street, Hobart.  
60 Waymouth Street, Adelaide. 87 Elizabeth Street, Brisbane. 20 Paterson Street,  
Launceston.

*Here they are!*

Microphones  
Coils  
Batteries  
Meters  
Switches  
Valves  
Vibrators  
Transformers  
Chokes  
Chassis  
Condensers  
Speakers

# Are You Looking for **SELECTIVITY?**

## Then Try the New **"AEGIS" HI-CORE I.F. TRANSFORMERS**

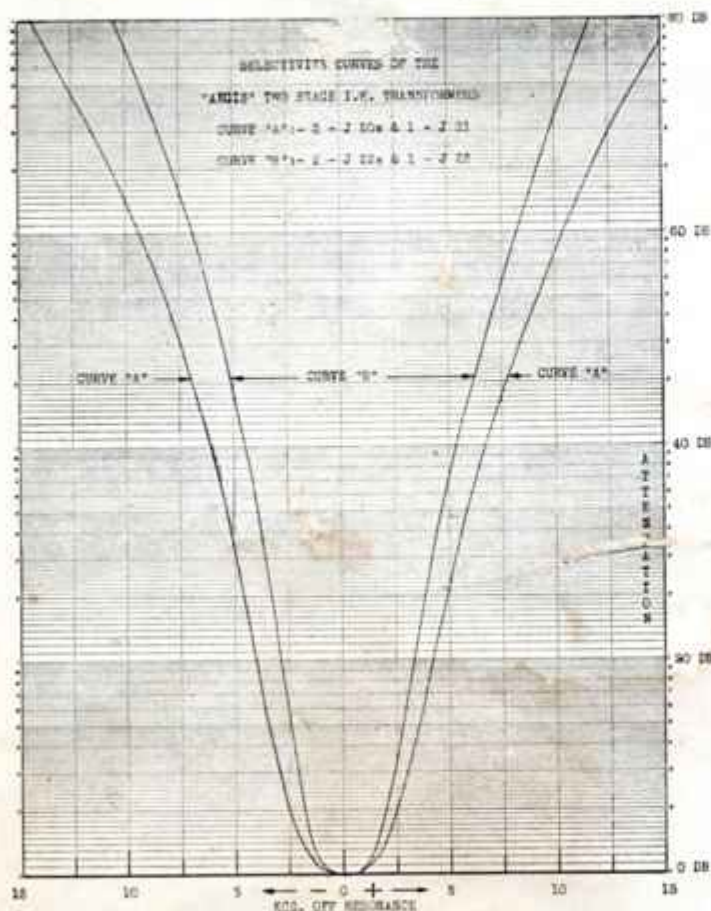

Scientifically Designed  
Expressly for the  
Two-Stage I.F. Channel

### INCORPORATING THESE FEATURES

1. Maximum Stability
2. Excellent Selectivity, particularly types J22/J23.
3. Effects of Tube Loading reduced to a minimum.
4. "Miller Effect" Detuning eliminated.

#### Medium Selectivity

Type J20 Interstage

Price 13/9 ea.

Type J21 Diode Price 13/9 ea.

#### Maximum Selectivity

Type J22 Interstage

Price 15/- ea.

Type J23 Diode Price 15/- ea.

NEW AEGIS D/W COIL ASSEMBLY  
Type K15 and K25.

Specially designed for the new  
**6.S.A.7 SINGLE-ENDED TUBE**  
No extra for this advanced feature!  
FROM ALL DISTRIBUTORS OF . . .

# AEGIS MANUFACTURING Co. PTY. LTD.

208 LITTLE LONSDALE ST., MELBOURNE