

AM · FM · TELEVISION

BROADCAST NEWS



Miniaturized Television Camera . . . Pg. 8

VOL. No. 71

Sept.-Oct., 1952





Changing the map of the world

—with *RCA Shoran*

A SHIP SANK in these remote straits—because a chart was wrong. But that won't fool navigators any more. Modern aerial survey . . . using RCA Shoran and photography together . . . recorded the *true* shoreline (the lines in white). Now, the charts are right!

Surpassing any optical survey system now in use, this radar "yardstick" can map land-and-water areas never explored by man—and do it at flying speeds as high as 600 mph. Accuracy is better than 50 feet in 100 miles or more. Here's how it's done.

Two widely separated SHORAN stations on the ground (or aboard ship) form the base of a triangle. The plane becomes the apex. Pulsed radar signals from the SHORAN are received by each ground station and retransmitted back to the pilot. On a radar screen the pilot sees one "pip" for each station signal. He calibrates the "pips" and gets his fix. Cameras used with the Shoran equipment simultaneously photograph the calibrations—and the ground along his course. *Result: a highly accurate and permanent record of every square foot he covers.*

Just another application of RCA Shoran—added to its use in locating oil wells, plotting microwave radio relay and pipeline routes, detecting mine fields, and precision bombing.



RADIO CORPORATION of AMERICA
ENGINEERING PRODUCTS DEPARTMENT

CAMDEN, N. J.

Broadcast News

AM • FM • TELEVISION

Published by the

RADIO CORPORATION OF AMERICA

ENGINEERING PRODUCTS DEPARTMENT . . . CAMDEN, NEW JERSEY

NUMBER 71

SEPTEMBER-OCTOBER, 1952

Subscription Rates

In continental U. S. A. • \$4.00 for 12 issues
In other countries . . . • \$5.00 for 12 issues

JOHN P. TAYLOR, Editor

W. O. HADLOCK, Managing Editor

M. L. GASKILL, E. C. MASON, Associate Editors

Contents

THE "WALKIE-LOOKIE"	by A. E. OHLER	8
UHF IN PORTLAND—HOW IS IT DOING?	by JOHN P. TAYLOR	16
FEED SYSTEMS FOR THE NEW TWELVE-SECTION SUPERTURNSTILE ANTENNA	by L. J. WOLF	38
"CLOSE-IN" COVERAGE WITH HIGH-GAIN VHF ANTENNAS	by IRL T. NEWTON	44
DIPLEXERS AND THE VHF FILTERPLEXER	by I. E. GOLDSTEIN AND H. E. KING	48
WBT'S NEW BTA-50F1 TRANSMITTER INSTALLATION	by F. R. BROWN AND M. J. MINOR	54
A PRESSURE MICROPHONE FOR TELEVISION AND BROADCAST SERVICE	by L. J. ANDERSON	58
RCA BROADCAST REPRESENTATIVES ASSUME NEW POSITIONS IN FIELD		62

Copyright 1952
Radio Corporation of America
RCA Victor Division
Camden, N. J.

2J8410

TMKS ©

PRINTED
IN
U.S.A.

OUR COVER picture shows the Vidicon type camera and microwave pack transmitter which make up the "Walkie-Lookie" equipment used by NBC at the political conventions this past summer.

Three of these equipments were made on special order by the RCA Engineering Products Department. It is not planned to offer this equipment for general use at this time. However, as a "portent of the future" it has an obvious interest to all TV broadcasters. The full story starts on Pg. 8.

Kodachrome from which the cover was reproduced was made by Rod Allen of our own photographic department.

START PLANNING NOW for the NARTB Engineering Conference which will be held concurrently with the NARTB Convention, Los Angeles, April 28-May 1.

Those of you who have attended these conferences in recent years do not need to be told about their value. Those who have not can take our word for it—there's nothing better. If you can attend only one engineering conference a year, this is it! The papers presented are of a very practical and useful nature, full of ideas you can use in your every-day operation. In addition you have a fine opportunity to "rub shoulders" with fellow engineers, learn how they are thinking, trade ideas and experiences.

The opportunity to visit the Los Angeles area at this time has several extra advantages. Both NBC and CBS have just completed huge new TV studio plants that are a must on every list of places to see. The Hollywood motion picture studios are becoming more and more important to TV programming. And there's always the Mt. Wilson "complex", the world's greatest aggregation of FM and TV transmitter plants.

Still another attraction this year is the fact that the SMPTE (Society of Motion Picture and Television Engineers) will be having their annual meeting at practically the same time (April 27-30) in the new Los Angeles Statler, only a couple of blocks away. Reciprocal registration is planned so that you will be able to attend meetings of both groups.

There will be the usual exhibit of the equipment of all manufacturers, this year a bigger and better show than ever with many new TV items.

Recognizing the increasing importance of the Engineering Conference, Harold Fellows, President of NARTB has appointed a General Guidance Committee to work with Neal McNaughton, NARTB Engineering Director, in planning this year's meeting. The committee includes: Raymond Guy, NBC, New York, chairman of the committee; Frank Marx, ABC, New York; William B. Lodge, CBS, New York; Rodney D. Chipp, DuMont TV Network, New York; Earl M. Johnson, MBS, New York; A. James Ebel, WMBD, Peoria, Ill.; and Carl Nopper, WMAR-TV, Baltimore, Maryland. A West Coast Committee is also being formulated to be in charge of West Coast activities.

A TV TRAINING COURSE, similar to those we have conducted at intervals in Camden during the past several years, will be held in Los Angeles immediately following the NARTB Convention. RCA and Industry engineers will be the instructors. Equipment sent out for the NARTB Exhibit will be used for demonstration.

A limited number of station engineers can be accommodated for this special session. So, if you are interested make an early reservation through your RCA Sales Representative.

VERY LATE is the word for this issue of BROADCAST NEWS. If you do not receive your copy until January don't feel neglected. The cover of this issue was printed several months ago (in a burst of unmitigated optimism). It is now six days before Christmas and we're just putting the issue to bed. But we've learned our lesson. Next year's covers will be marked for the months in which they are mailed.

RCA

UHF

AGAIN, RCA sets a record in UHF technical leadership—by delivering to KPTV the entire UHF transmitter plant that put the FIRST commercial UHF signals on the air.

Out of the experimental field into the practical, RCA transmitter-antenna combinations like those shown here make UHF planning a practical reality. They enable you to obtain the most coverage at minimum investment.

◀ RCA UHF PYLON ANTENNA. The high-gain TV antenna that includes a vertical beam-fill arrangement—enabling you to cover specific areas more effectively. Horizontal radiation pattern of the Pylon is virtually circular.

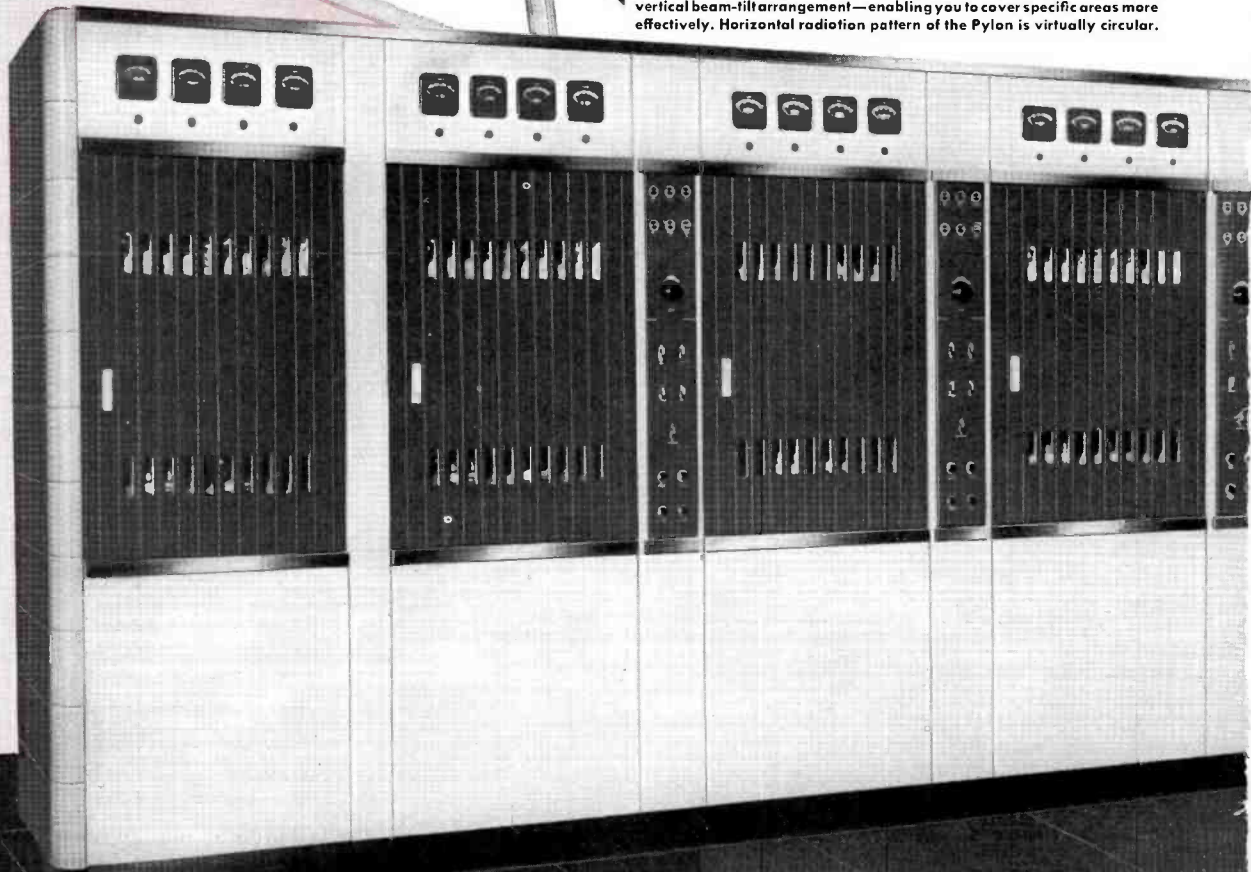

10-KW TYPE TTU-10A (FOR ERP* TO 270 KW). This UHF transmitter, and a UHF Pylon Antenna, will produce from 240 to 270 kw ERP on channels 14 to 83. The combination is capable of serving almost any metropolitan area with strong signals. Type TTU-10A is designed for straight-line or block "U" arrangements.

*Effective Radiated Power

proved in Portland!

For example, in low-power operation, RCA's low-cost 1-kw UHF transmitter and a high-gain Pylon Antenna combination is the most economical choice. Or, if you require higher power, RCA's "10-kw" UHF and a high-gain Pylon combination approaches the ultimate in useful coverage.

In addition to transmitter-antenna combinations, RCA also has the UHF accessories you need to go "on air"; transmitter monitoring equipment, trans-

mission line fittings, towers, consoles, UHF loads and wattmeters, Filterplexers, etc. Everything is "systems matched" to work together for maximum performance. All equipment is available from ONE responsible transmitter manufacturer—RCA.

Make sure YOU get your UHF equipment when you need it. Your RCA Broadcast Sales Representative is ready to take your order—and show you what you need to go UHF at lowest cost.

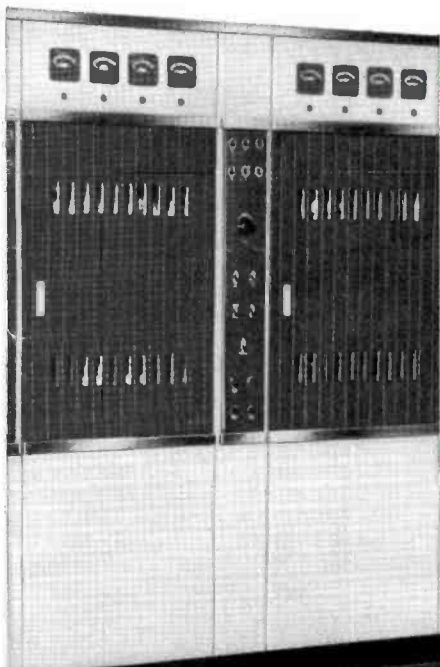

1-KW TYPE TTU-1B (FOR ERP* TO 27 KW). This transmitter and a UHF Pylon Antenna, can develop from 24 to 27 kw ERP on any channel, 14 to 83. TTU-1B is self-contained and all air-cooled. It is well suited as a driver for a high-power amplifier.



RADIO CORPORATION of AMERICA
ENGINEERING PRODUCTS DEPARTMENT

CAMDEN, N.J.

Completely

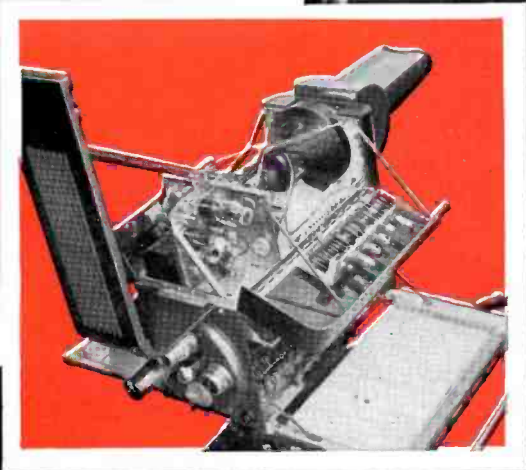
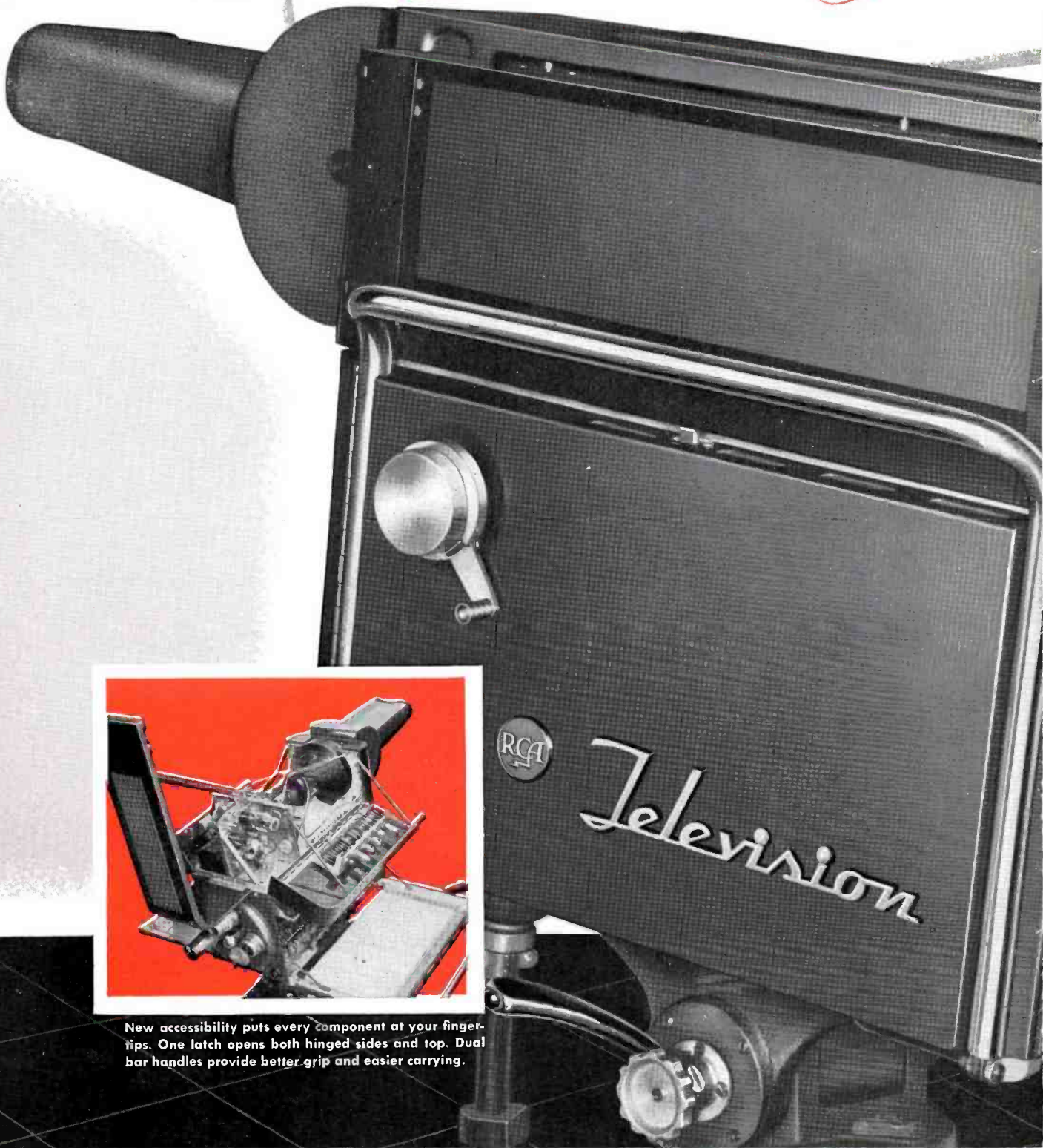

New accessibility puts every component at your fingertips. One latch opens both hinged sides and top. Dual bar handles provide better grip and easier carrying.

New!

RCA TV CAMERA

TYPE TK-11A

Here is the all-new TV camera the industry is talking about. The camera the leading networks are planning to use in their new Hollywood studios! The camera which will be used in most of the new stations this year—and next!

Leading network engineers (after

careful tests) have proclaimed the TK-11A the finest camera ever produced, easiest in the world to handle, and the simplest one to get at.

The TK-11A has all the proven performance of the world-renowned RCA TK-10—plus these new features:

NEW 7-inch viewfinder picture tube produces larger, brighter, and sharper pictures to help the cameraman.

NEW plug-in, high-stability video amplifier—with frequency response uniform to 8.5 Mc.!

NEW fixed-position alignment coil for the Image Orthicon. Electrical control of coil eliminates all mechanical adjustments!

NEW plug-in blower for cooling the deflection coil and the Image Orthicon!

NEW electronic-protection system guards your Image Orthicon against deflection failure, or loss of driving signals.

NEW "overscan" control takes burden off Image Orthicon during warm-ups and rehearsals; new vertical reverse switch for film pick-ups.

For complete information on the TK-11A,
call your RCA Broadcast Sales Representative.



RADIO CORPORATION of AMERICA
ENGINEERING PRODUCTS DEPARTMENT
CAMDEN, N.J.

UHF pylons

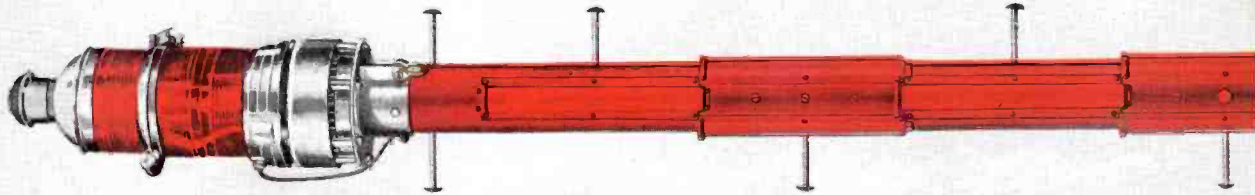

Adjustable Beam, High-Gain TV Antennas

Check these 9 features

Any power to 1000 KW

RCA UHF Pylons have ratings suitable for any transmitter power up to 50 kw. . . and for an ERP (Effective Radiated Power) up to 1000 kw.

Power gains up to 27

RCA UHF Pylons can be furnished with gains in the order of 3, 6, 9, 12, 21, 24 and 27.

Adjustable beam tilt

The "Beam Tilt" of the RCA UHF Pylon is a "built-in" feature. Easily adjusted in the field, you are assured of best possible coverage and maximum vertical pattern reinforcement. Mechanical "beam tilt" by leveling plates—electrical "umbrella" effect by sliding transmission line fitting.

Near perfect circularity

With the RCA UHF Pylon, you get equal signal in all directions. The measured and theoretical patterns are within 1% of a perfect circle!

No protruding elements

Nothing "sticks out" from the RCA Pylon. The smooth surface of the pipe itself is the radiator. There's nothing to bend or break under ice or wind load.

No tuning adjustments

The RCA UHF Pylon is "custom tuned" for your frequency—in the RCA plant. You put it up, connect the line, and throw the switch! Absolutely no tuning required.

Null fill-in

High-gain antenna measurements show the first null filled in about 10%—satisfactory for

all except unusual mountain top locations. See the curves below.

Special matched transmission line

No UHF antenna will function properly unless the transmission line closely matches the antenna. RCA supplies *specifically designed* lines, not available anywhere else. Factory tests on this line show VSWR better than 1.05 to 1.0.

Complete accessories available

RCA can supply transmission line fittings, towers, directional couplers, signal demodulators, UHF loads, wattmeters, filterplexers—all *specifically designed* to work with the UHF Pylon.

REMEMBER! Only by having *everything matched* from transmitter to antenna can you be sure of results. Why take a chance? Call your RCA Broadcast Sales Representative.

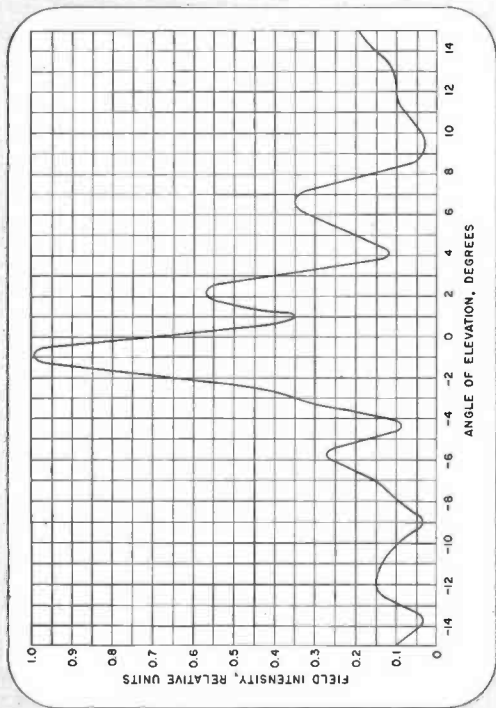

Typical measured vertical field pattern of a UHF Pylon. Phasing adjusted for 0.92° pattern tilt.

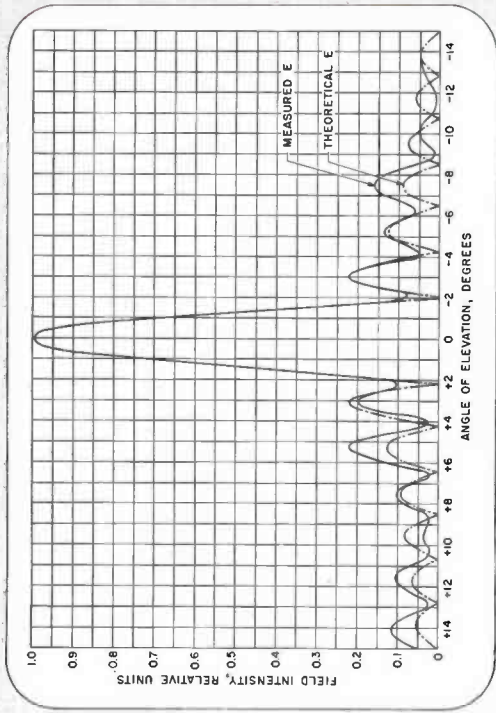

Typical calculated and measured vertical field pattern of a UHF Pylon. Channel 75 (838 Mc).

RCA's UHF Pylon



RADIO CORPORATION of AMERICA
ENGINEERING PRODUCTS DEPARTMENT
CAMDEN, N.J.



FIG. 1. The "Walkie-Lookie" equipment built for NBC includes a miniature-size camera using the new RCA 6198 Vidicon Camera Tube, a backpack transmitter operating in 2000 megacycle band, and a fixed-station control equipment (shown in Fig. 14).

THE "Walkie Lookie" A MINIATURIZED TV CAMERA CUSTOM BUILT FOR USE BY NBC AT NATIONAL POLITICAL CONVENTIONS

By **A. E. OHLER**
RCA Engineering Products Department

In the past fifteen years great improvements have been made in the performance of the television camera and its associated control equipment. What was once the greatest limitation, namely, the need for very high light levels, was all but eliminated by the development by RCA engineers of the image orthicon camera. Improvements in camera circuits, although less spectacular in nature, have been equally important. The newest RCA cameras (Type TK-11A and TK-31A)¹ also incorporate very important mechanical improvements which greatly increase the reliability of the camera, and hence of the system. These include ruggedness of construction, improved components and accessibility for servicing.

However, these important advancements in performance and reliability have not

appreciably changed the physical limitations on maneuverability which are imposed by the camera. These limitations are, first, the size of the standard camera, and second, the fact that it must be tied to its control unit by a cable. It is interesting to note that the size of TV cameras has not changed much since the first iconoscope camera was described by Dr. V. K. Zworykin in BROADCAST NEWS No. 8, August 1933.²

The main reason camera sizes have not changed much is that the size of the camera is determined, to all practical purposes, by the size of the pick-up tube. In the evolution of the pick-up tube, from the iconoscope to the orthicon, to today's image orthicon, the overall length of the tube has not changed materially (although the bulkiness has been decreased some-

what). Consequently no important reduction in the size of the camera has been possible to date.

The Vidicon

The first ray of hope in this situation was the development of the Vidicon by RCA Laboratories. The first developmental models of this small-sized pick-up tube provided a performance which was considerably short of broadcast standards in several respects. However, a continuous program of improvement has been going on, and a commercial model of the tube was announced in August. This tube, the RCA 6198, is being used in the Type ITV-6 Industrial Television System, of which RCA has already built a considerable quantity.

The first actual use of the Vidicon for TV broadcasting occurred during the National Democratic and Republican Conventions. Three equipments of the type

¹ BROADCAST NEWS No. 68, March-April 1952. "A New Television Camera for Studio and Field Use."

² BROADCAST NEWS No. 8, August 1933. "The Iconoscope—A Modern Version of the Electric Eye."

shown in Fig. 1 were built by RCA Victor for NBC on special order. Because of its very specialized nature it is not planned to offer this equipment for general use. However, because of the very widespread interest in this development it is felt that a description of the equipment will be of interest.

The Background Development

The design of the "Walkie-Lookies" built for NBC was based on the early work done by the RCA Laboratories. A fundamental background of Vidicon experience was available from work carried on in the allied field of industrial television under the direction of Dr. V. K. Zworykin at the David Sarnoff Research Center. Dr. Zworykin also initiated a program to develop a camera and pack unit capable of functioning on its own battery power, and containing a transmitter operating in conjunction with a control station. A successful model was completed and demonstrated by RCA Laboratories personnel at the March 1951 Convention of the Institute of Radio Engineers in New York City. (See "RCA Review," March 1952 for "A Developmental Portable Television Pickup Station," by L. E. Flory, W. S. Pike, J. E. Dilley, and J. M. Morgan.) The pack unit compared favorably in size and in portable application with its famed battery-operated counterpart, the "Walkie-Talkie" Transceiver. It provided a 525-line, 30-frame interlaced picture and admirably indicated future possibilities for commercial use by the elimination of trailing wires and heavy equipment which would otherwise limit the scope of operation. Provision for obtaining a standard RMA composite video output was not available from this model, however, nor was the microwave link designed to operate in the 2000 Mc microwave channel which was considerably above the experimental operating frequency of 593.96 Mc.

TV Broadcasters Exhibit Interest

Interest resulting from the demonstration of this innovation in television pickup systems was gratifying and directed further thought to its use at sporting events such as football or baseball games and prize fights. Other suggested uses have been the coverage of disaster areas and the telecasting of special events including appearances by notables in the news. In order to test out these possibilities, NBC ordered three "Walkie-Lookie" Portable Television Equipments, adaptable to network use,

from the Engineering Products Department of the RCA Victor Division.

"Walkie-Lookie" at National Conventions

Delivery of the "Walkie-Lookie" Portable Television Systems to NBC in time for the National Republican and Democratic Presidential Conventions, held in the Chicago Amphitheater, Chicago, Illinois during the weeks of July 7 and July 21, 1952, made possible a degree of freedom and flexibility in news coverage that was never before attained. The use of the miniature hand-carried camera and back-pack transmitter enabled commentators and observers to penetrate areas inaccessible to the standard cameras. Moreover, the speed with which this camera could be moved to a point of action on the floor made it possible to get close-ups of scenes which would otherwise have been missed.

The "Walkie-Lookie" Equipments used by NBC for network operation at the Conventions were patterned after the original RCA Laboratories' prototype. However, several engineering modifications had to be introduced before it was possible to make the televised scenes visible to the home

viewers tuned to NBC stations. The three basic elements of the portable system were retained, the Camera, Pack Unit, and Base Station, with each revised electrically or mechanically, as necessary, to fit the network operating requirements.

The major design changes made in the "Walkie-Lookie" system to afford network transmission are:

1. Pack-sync control signals stripped at base station and standard sync inserted to provide standard RMA composite video output at network terminals.
2. Video transmitter frequency changed from experimental frequency 593.96 Mc to 2000 Mc.
3. Transmitter simplification achieved by use of single-tube, cavity oscillator.
4. A quartz crystal employed to control pack sync generator instead of 60-cycle reference signal originating from base station.
5. Pack arranged to be used also as miniature television pickup unit with direct video output over coax connection to



FIG. 2. Another "action shot" taken at the Republican National Political Convention in Chicago. Note the microwave equipment shown mounted on a platform above the "Walkie-Lookie" Unit.



FIG. 3. Exterior view illustrating the portable units of the "Walkie-Lookie." This comprises a complete Pack Transmitter (at left) and Camera (at right). Total Pack Unit weight is approximately 50 pounds.

Features of the camera include an electronic viewfinder, a rotatable turret capable of mounting three sixteen-millimeter movie-type lenses, provisions for hand-carrying or tripod-mounting, all controls located on top of camera for ease of operation, and optical focusing, easily accomplished by manual adjustment.

The three essential circuit elements housed in the camera and their functions are:

1. The Vidicon pickup tube used to produce the video signals.
2. The video preamplifier used to amplify the Vidicon output.
3. The kinescope viewfinder, employing a miniature picture tube of the same dimensions as the Vidicon to supply the cameraman with an exact reproduction of the scene on which the camera lens is focused.

A four-foot cable between the camera and pack permits sufficient flexibility of operation without unwieldiness. Deflection signals for the Vidicon and kinescope, camera blanking, and tube heater power originate in the pack unit and are transmitted over the camera cable, which also includes a coax for video signals emanating from the camera. Interconnection details and signal paths are shown in Fig. 7, a block diagram of the Camera and Pack Unit. The total tube complement of the camera comprises five tubes including the Vidicon and one-inch kinescope.

base station in cases where applications do not permit microwave operation.

6. Structural changes made in the camera, pack, and base station rack assembly resulted in additional streamlining, and accessibility of all units for servicing and maintenance.

three lenses mounted in the turret is only seven and one-half pounds. This light weight is, in part, the result of the simplicity of the Vidicon deflection system which employs only one coil assembly, the deflection yoke. Permanent magnet focusing and alignment is employed for weight reduction.

A detailed description of the three fundamental components of the "Walkie-Lookie" equipments as built for NBC is as follows:

The "Walkie-Lookie" Camera

The camera is an adaptation of the RCA Industrial Television Camera using the Vidicon Tube. The ability to miniaturize the camera to its dimensions of three inches in width by six and one-half inches high by nine inches in length is primarily because of the small size of the pickup tube. Despite its small size, one inch in diameter by six inches long, the Vidicon with its photo-conductive target is capable of a maximum resolution of about 400 lines. Horizontal resolution of 350 lines is nominal for the overall system although even higher resolution is possible under optimum conditions. Weight of the camera with

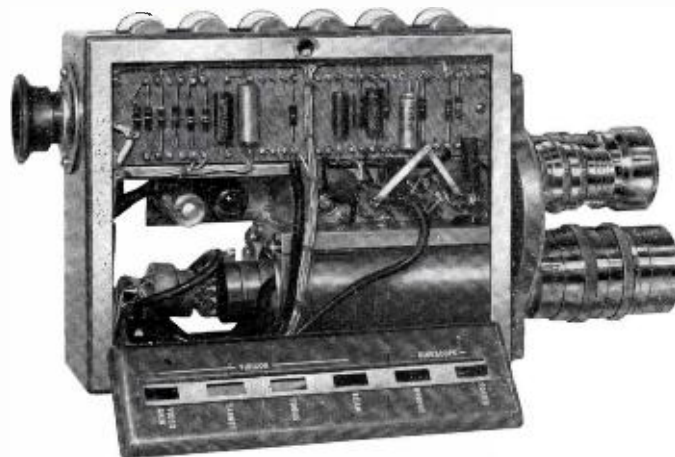

FIG. 4. View of the "Walkie-Lookie" Camera Unit with side panel removed to illustrate smaller components and terminal boards employed.

"Walkie-Lookie" Pack Unit

The "Walkie-Lookie" Pack Unit, complete with circuit components and batteries is in a streamlined case finished in blue-gray. (Total Pack Unit weight, 51 lbs.) Dimensions of the Pack are 6¾ inches deep at the bottom tapering to a depth of 5 inches at the top by 14 inches wide by 19¼ inches in height. The pack is carried "knapsack" fashion suspended from the cameraman's shoulders by leather straps. Suitable padding protects the back from chafing. Interior access is gained through a removable rear cover plate which is perforated for ventilation.

Important features of the pack operation are that audio, video, and sync information are transmitted over a single 2000 Mc R-F carrier. This is possible by the use of pulse-width modulation of the horizontal sync signal at an audio rate. Although a complete aural system was incorporated in the "Walkie-Lookie" (and is described in this article), it was not used at the Conventions in Chicago where the RCA "Radio-Mike" was employed to better advantage. The composite video signal is then used to amplitude-modulate the high-frequency cavity oscillator. Stabilization of the sync generator is established locally by means of a 94.5 KC crystal and appropriate frequency-dividing circuits. Approximately 1½ hours of Pack operation is possible before the batteries require recharging.

Housed within the Pack are the following main chassis assemblies which have

FIG. 5. A view of the opposite side of the "Walkie-Lookie" with panel removed to show the tubes and deflection assemblies.

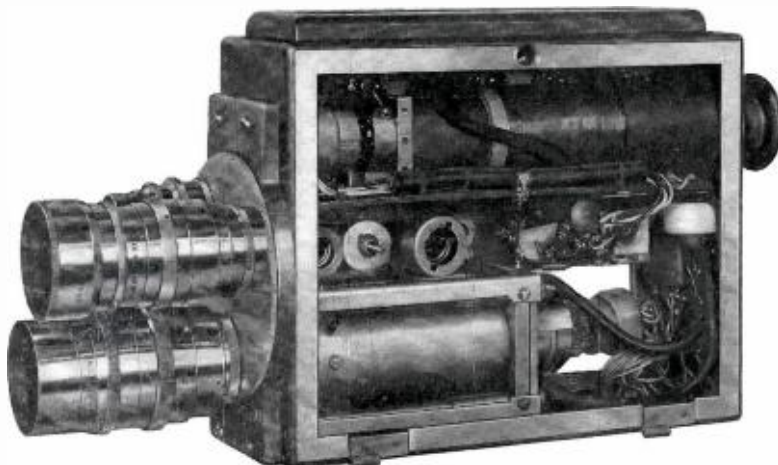

FIG. 6. At left, Morgan Beatty, shown with an RCA "Radio-Mike" and, at right, Sal Benza with the "Walkie-Lookie", as used at Republican National Political Convention in Chicago.

been designed as plug-in units to facilitate service and maintenance: The 2000 Mc Transmitter, the Audio Amplifier and Pulse Width Modulator, the Video Amplifier and Modulator, the Sync Generator, and the Deflection and Blanking Circuits (refer to Fig. 7, Block Diagram of Camera and Pack Units, for interconnection and signal paths). The Power Supply, including Dynamotor and Batteries, is located in the bottom of the cabinet. Five 1.5-volt

"Yardney Silver Cell" batteries are mounted within a removable drawer in order to effect rapid interchange with a set of freshly charged batteries when recharging is necessary.

The six Pack System chassis employ a total tube complement of only twenty-seven tubes. (Refer to photograph, Fig. 11, for internal view of Pack showing chassis in place): The bottom chassis contains a common horizontal deflection circuit for the Vidicon and viewfinder kinescope. The chassis directly above provides vertical deflection for the Vidicon and viewfinder kinescope and blanking pulses for the Vidicon. Third from the bottom is the crystal controlled sync generator which provides line and field frequencies. The Video Amplifier, having a 5-Mc bandwidth, is mounted on number four chassis as well as the Modulator which mixes video and the audio-modulated horizontal sync pulses to obtain a composite modulation signal. The fifth chassis contains the audio amplifier which amplifies the microphone output, and the pulse-width modulator which varies the width of the horizontal sync pulse at an audible rate. The Transmitter, occupying the top chassis, employs a Type 5893 Pencil Triode Tube in a cavity oscillator and

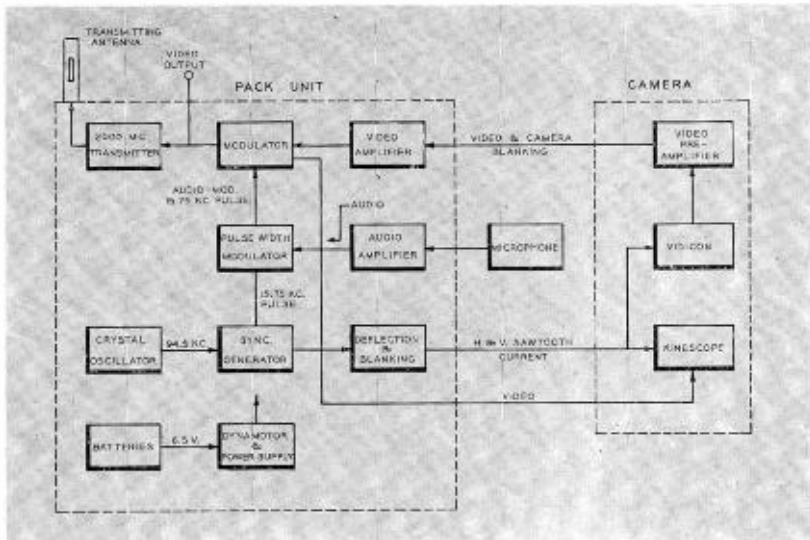

FIG. 7. Block diagram of the Pack Unit and Camera showing the interconnections and signal path.

is amplitude-modulated by the composite video signal from the Modulator. The frequency is adjustable to cover Channel 4, 2008 Mc and Channel 5, 2042 Mc.

The Pack Transmitter has been used with both "slot" and "vertical" antennas. Practically circular radiation patterns in the horizontal plane occur in either case but the differences in polarization have a noticeable effect on signal stability with indoor use. The vertical antenna, with vertically polarized propagation, proved most effective for indoor use at the Conventions.

Total power consumption of the Pack unit is about 200 watts. Battery voltage is monitored by a miniature voltmeter

mounted on the side of the Pack cabinet. Other externally mounted accessories include a coax receptacle for direct video output, by-passing the transmitter. A switch permits "biasing-off" the transmitting tube during this mode of operation. Seventy-five ohm, RG-59U Cable transmits the video signals to the Base Station when direct video feed is required. An RCA Starmaker Microphone, MI-11005,



FIG. 9. View of the cavity oscillator or transmitter used in the "Walkie-Lookie" Pack Unit.

FIG. 8. Below is a view of the battery drawer assembly, complete with a set of the batteries required for use.

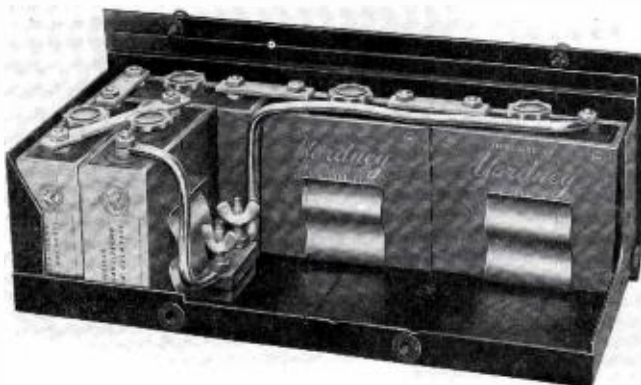

fied field camera control, MI-26065A. The sync separator uses the leading edges of the horizontal sync pulses transmitted from the pack to reconstruct a constant width sync pulse and to extract the sound information from the trailing edges. On recovery of audio information, conventional amplifiers boost the signal for local monitoring and audio programming. The Genlock, MI-26288, allows the reconstructed sync pulse to be compared in phase with the locally generated horizontal drive pulse. The output of the Genlock oper-

may be conveniently used as the source of audio pickup.

Base Station

Reception of signals from the Pack Unit is accomplished by an RCA Microwave Receiver, Type TRR-1B, modified for 2000 Mc operation. The Receiver, MI-26181, was converted for AM reception, a new mixer substituted and a new Klystron cavity local oscillator designed and built. A factor in the selection of the Type TRR-1B Receiver for the "Walkie-Lookie" system was the wideband response of the I-F circuits in the Receiver Control, MI-26310A. AGC action in the Receiver Control was extended by applying the control signal voltage to additional tubes. A parabolic antenna with a three-foot diameter and a gain factor of approximately 225 is used with the receiver. Very smooth antenna panning is possible with the tripod and friction head mount. A standard type, TY-25A Portable Power Supply, feeds the receiver. An RCA model 17T-154, 17-inch Television Receiver, modified for video and audio monitoring, is located close to the receiving antenna so that antenna orientation can be checked for best signal strength.

The composite video output from the receiver is fed into the rack-mounted sync and sound recovery panel, and to a modi-

ates through a reactance tube in a modified field sync generator, Type TG-10A, to bring these pulses in phase. The field sync generator, comprising the pulse former, MI-26105, and pulse shaper, MI-26115, produces standard sync, drive, and blanking pulses which are mixed with the received video in the camera control unit. Prior to the mixing process, the variable width sync pulse, as received from the Pack, is removed by mixing blanking and video, clamping on the back porch and then clipping off all sync and part of the blanking pulse to obtain a flat pedestal for addition of the sync pulses. Clamping, here, is critical since it cannot occur on the top of sync because of the variable width characteristic, yet it must be performed within the duration of blanking in order to preserve picture quality. Keying pulses for clamping is timed by a delayed pulse derived from the local horizontal

FIG. 10. Closeup of the "Walkie-Lookie" Pack Unit showing the various "plug-in" chassis arrangement used.

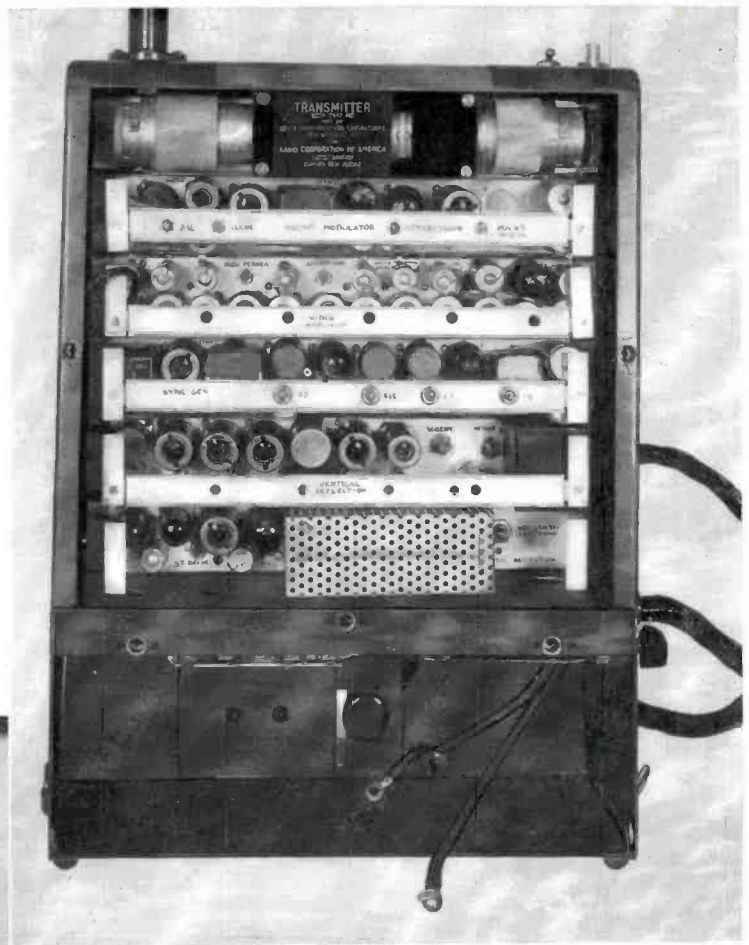
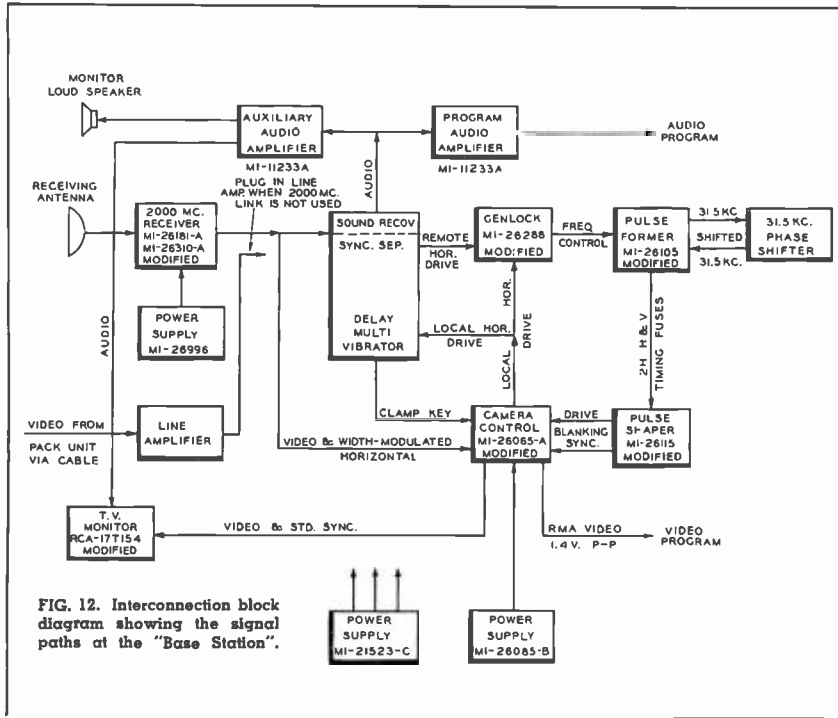

FIG. 11. At left, T. A. Smith, Assistant Manager of Engineering Products Department, and, at right, V. E. Trouant, Chief Commercial Design Engineer for Engineering Products, inspect "Walkie-Lookie" during tests at Camden prior to delivery to the Political Conventions in Chicago.

drive in a multivibrator located on the sync and sound recovery panel.

The vertical sync pulses developed in the Pack are synchronized to the horizontal sync pulses, both of which are ultimately derived from the crystal controlling the sync generator. The horizontal and vertical sync pulses are likewise synchronized in the field sync generator; however, there are no vertical sync pulses transmitted from the Pack. The Genlock, therefore, can lock the phase of the locally generated horizontal pulses to any one of 525 possible positions relative to the Pack vertical pulse. This effect generally means that the transmitted vertical blanking bar will appear in the picture and must be eliminated. A phase filter is used at the Base Station



to shift the phase of the 31.5 KC pulses fed to the 525 frequency divider chain, but not the "divide-by-2" stage of the pulse former. In this device, the 31.5 KC pulses are converted to a sine wave which is then changed by phase splitters into a three-phase voltage applied to the stator of a synchro at 120° intervals. The rotor signal of the synchro is shifted in phase by rotation of any desired amount, thus permitting the blanking bar to be eliminated from the picture in either an upward or downward direction.

Base Station Equipment Rack

Arrangement of equipment in the 84-inch Base Station Rack, from top to bottom, is as follows: At the top is a VU Meter Panel, Type B1-5A and below it is the Genlock. Panel Number Three contains the Auxiliary Monitoring Audio Amplifier and Program Audio Amplifier. Both amplifiers are identical units, MI-11233A. The Sync Separator and Sound Recovery Panel occupy the fourth panel position. The fifth panel space comprises a Frequency

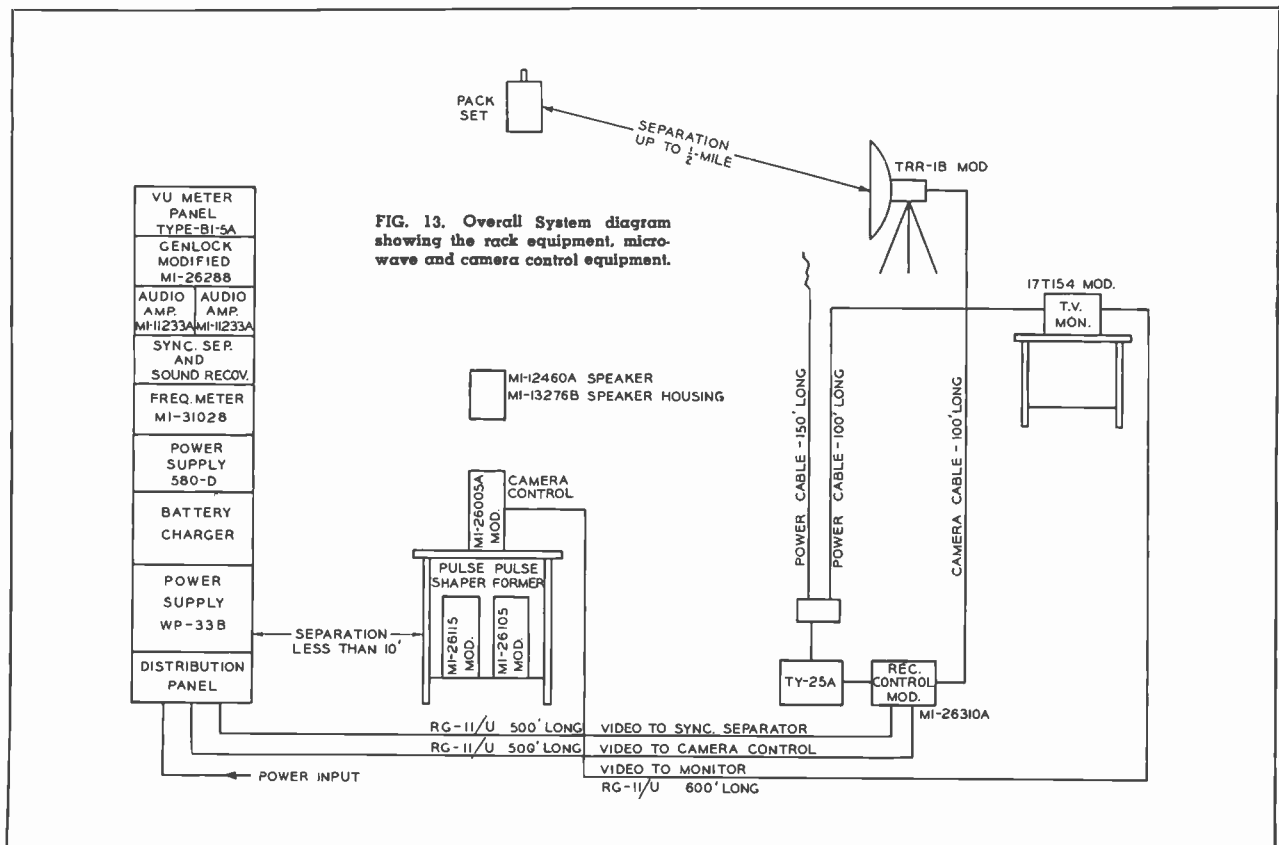



FIG. 14. View of the overall equipment which comprises a complete "Walkie-Lookie" system.

Meter, MI-31028, and Grid Current Meter for checking the transmitter, and a main Circuit Breaker for disconnecting the base station from the input-power line. A Type 580-D Power Supply, MI-21523C, follows on the rack. This unit provides power for the Genlock and Audio Amplifiers. Next is a special battery charger which includes an automatic cutoff when the batteries have reached full-charge. Sufficient filtering is available to operate the "Pack" directly from the charger in order to conserve battery life during test or set-up periods. Another Power Supply unit, Type WP-33B, MI-26085B, is the eighth rack component. This equipment supplies power to the Camera Control Unit and the Sync and Sound Recovery Assembly. A distribution panel is located at the bottom for convenience in attaching interconnecting cables. The entire rack is mounted on a wheeled platform to afford mobility. The Camera Control, Field Sync Generator, and Phase Shifter are mounted on an inclined

Field Desk for operating convenience. The same type of mounting is also provided for the TV receiver serving as a remote monitor at the antenna location.

Extreme flexibility is obtainable in the Base Station layout since it is possible to operate the TRR-1B Microwave Receiver Control at distances up to 1000 feet from the rack assembly. Further, the combined Microwave Receiver and Parabolic Antenna are provided with a 100-foot cable which extends the radius of operations still farther.

From the Base Station, signal levels available to the network terminals are:

Audio Output: +4 VU level at 150 ohms impedance.

Video Output: 1.4 Volts peak to peak, sync negative at 75 ohms impedance level. RMA Standard.

The Base Station power input requirement is approximately 2 KW at 117 volts

AC, 60 c.p.s. The useful range of the present equipment is approximately $\frac{1}{4}$ mile separation between Pack and Base Station.

It should not be concluded or even surmised that the "Walkie-Lookie" will supersede present studio and field pickup equipment. It may serve as a convenient, supplementary source for special programming. The considerable interest aroused by this project indicates the possible future use of miniaturized pickup equipment by television stations. Engineering development and design is continuing at RCA in order that future commercial availability can be assured.

The author wishes to acknowledge the contributions of the following RCA Groups who have assisted in making the "Walkie-Lookie" project a success: RCA Laboratories, RCA Tube Department, the NBC Engineering Department and also other groups in the Engineering Division of the Engineering Products Department.

Portland TV Station Puts Tests on Air

The first "live" telecast from a Portland television station will go on the air at 4:30 p. m. PST Saturday from the transmitter of station KPTV on Council Crest, R. G. Freeman, vice president of the station's operating company, announced today.

Television broadcasting began in Portland at 12:01 a. m. today when KPTV started telecasting a stationary geometric test pattern. KPTV thus became the first commercial station in the United States to telecast in the recently authorized ultra high frequency (UHF) range.

Independent Monitors Find Signal Strong

Independent engineers monitoring the test said it was strong, steady and bright as far away as Vancouver. KPTV plans to transmit the test pattern during daylight in the next few days to assist servicemen in installing TV sets.

The first of these were picked up shortly after 11 a. m. today. Details of the first live program have not yet been entirely worked out, Freeman said.

Press Views KPTV Operation. Now Televising Test Patterns

BY JAMES STEWART

See Story on Page 1. Also

Television-happy Portland got a look inside the cause of it all Thursday—the control room of KPTV, the country's only commercial ultra high frequency television station.

The station's nerve center, a maze of complicated electrical apparatus in an unfinished building atop Council Crest, was opened for press inspection Thursday afternoon by Herbert Mayer, president of Empire Coil company, owner of KPTV.

Mayer flew into town with his family Wednesday night about seven hours after KPTV flashed the first television signal—an Indian head test pattern—on Indian head test pattern.

Previous to Thursday afternoon, the bush-hush going on behind the canvas curtains on Council Crest had caused considerable speculation nationwide, particularly in television circles.

Two Questions Answered

Some of the speculation came from two big unanswered questions: Why would the federal

by Ruse Alton, KPTV's permanent chief engineer. Openly, Mayer was with Scripps Howard radio in Cleveland, O., where Mayer owns another television station.

Deming flashing screens the only television station.

with the UHF signal.

from a stop. A week's hearing.

A picture of the test pattern.

parade "live" heavy.

administration ap-



VOL. 11, NO. 100 PORTLAND, OREGON, THURSDAY, SEPTEMBER 18, 1952 TEL. CAPITOL 5511 56 PAGES PRICE 5c

First Portland TV Signals Sent 12:01 a. m. Thursday

Portland's "teletiveness" ended officially at 12:01 a. m. Thursday with the first telecast of an ultra high frequency test pattern from KPTV atop Council Crest.

The first commercial telecast will be Saturday afternoon. The city's first telecast—a stationary geometric pattern—was transmitted through the early morning hours to allow station technicians and RCA officials to determine how the signal was coming through at various parts of the city and in Vancouver, Wash. This followed FCC approval late Wednesday of KPTV's special permits to transmit.

Tests Reported Excellent

R. G. Freeman, vice president of Empire Coil company, owner of KPTV, said the test patterns were "excellent."

His enthusiasm was backed by RCA officials and Herbert Mayer, president of Empire Coil, who arrived in Portland before the initial telecast of his Portland station, which is the first commercial UHF station in the country.

Mayer, his wife and one of their daughters joined RCA officials in a specially equipped UHF test truck for the first showing. The truck was parked at N. E. 44th avenue and Sandy boulevard shortly before midnight Wednesday. At the appointed time—one minute past midnight—the station came on the air.

TODAY: Television



UHF Television Signal Success

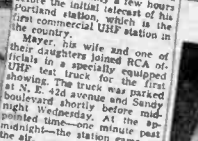

Portland TV Station Tests Get Under Way



Geometric Pattern Named Beautiful; Program Saturday



Three Hours Of TV Planned For Premiere



Press Views KPTV Operation. Now Televising Test Patterns

BY JAMES STEWART

See Story on Page 1. Also

Television-happy Portland got a look inside the cause of it all Thursday—the control room of KPTV, the country's only commercial ultra high frequency television station.

The station's nerve center, a maze of complicated electrical apparatus in an unfinished building atop Council Crest, was opened for press inspection Thursday afternoon by Herbert Mayer, president of Empire Coil company, owner of KPTV.

Mayer flew into town with his family Wednesday night about seven hours after KPTV flashed the first television signal—an Indian head test pattern—on Indian head test pattern.

Previous to Thursday afternoon, the bush-hush going on behind the canvas curtains on Council Crest had caused considerable speculation nationwide, particularly in television circles.

Two Questions Answered

Some of the speculation came from two big unanswered questions: Why would the federal

First Tests by Portland's UHF Station Found to Have Given Excellent Results

Rose's First Witness

In the party was J. T. Rose, an RCA vice president. He reported the first Portlanders to see the broadcast from the truck were Mr. and Mrs. Tom Rose, who just happened to be in the party.

An RCA technician said the UHF signal was "excellent."

His enthusiasm was backed by RCA officials and Herbert Mayer, president of Empire Coil, who arrived in Portland before the initial telecast of his Portland station, which is the first commercial UHF station in the country.

Mayer, his wife and one of their daughters joined RCA officials in a specially equipped UHF test truck for the first showing. The truck was parked at N. E. 44th avenue and Sandy boulevard shortly before midnight Wednesday. At the appointed time—one minute past midnight—the station came on the air.

Tests Reported Excellent

R. G. Freeman, vice president of Empire Coil company, owner of KPTV, said the test patterns were "excellent."

His enthusiasm was backed by RCA officials and Herbert Mayer, president of Empire Coil, who arrived in Portland before the initial telecast of his Portland station, which is the first commercial UHF station in the country.

Mayer, his wife and one of their daughters joined RCA officials in a specially equipped UHF test truck for the first showing. The truck was parked at N. E. 44th avenue and Sandy boulevard shortly before midnight Wednesday. At the appointed time—one minute past midnight—the station came on the air.

Portland Hails KPTV, Television Pioneer

Portland saluted its television pioneer Saturday with a luncheon, a switch flipping ceremony and a specially arranged program that was to be beamed from the towering antenna on Council Crest at about 4:30 p. m.

Taking the applause was the ultra high frequency station of KPTV, first in the nation.

The station's nerve center, a maze of complicated electrical apparatus in an unfinished building atop Council Crest, was opened for press inspection Thursday afternoon by Herbert Mayer, president of Empire Coil company, owner of KPTV.

Mayer flew into town with his family Wednesday night about seven hours after KPTV flashed the first television signal—an Indian head test pattern—on Indian head test pattern.

Previous to Thursday afternoon, the bush-hush going on behind the canvas curtains on Council Crest had caused considerable speculation nationwide, particularly in television circles.

Two Questions Answered

Some of the speculation came from two big unanswered questions: Why would the federal

Three Hours Of TV Planned For Premiere

Portland to See Margaret Truman In Network Show

Portland's first television station, KPTV, plans to broadcast three hours of "live" television from 4:30 to 7:30 p. m. PST Saturday for the premiere.

The station's nerve center, a maze of complicated electrical apparatus in an unfinished building atop Council Crest, was opened for press inspection Thursday afternoon by Herbert Mayer, president of Empire Coil company, owner of KPTV.

Mayer flew into town with his family Wednesday night about seven hours after KPTV flashed the first television signal—an Indian head test pattern—on Indian head test pattern.

Previous to Thursday afternoon, the bush-hush going on behind the canvas curtains on Council Crest had caused considerable speculation nationwide, particularly in television circles.

Two Questions Answered

Some of the speculation came from two big unanswered questions: Why would the federal

Portland TV Station Tests Get Under Way

The first "live" telecast from Portland television station will go on the air at 4:30 p. m. PST Saturday from the transmitter of station KPTV on Council Crest, R. G. Freeman, vice president of the station's operating company, announced today.

Television broadcasting began in Portland at 12:01 a. m. today when KPTV started telecasting a stationary geometric test pattern. KPTV thus became the first commercial station in the United States to telecast in the recently authorized ultra high frequency (UHF) range.

Independent engineers monitoring the test said it was strong, steady and bright as far away as Vancouver. KPTV plans to transmit the test pattern during daylight in the next few days to assist servicemen in installing TV sets.

The first of these were picked up shortly after 11 a. m. today. Details of the first live program have not yet been entirely worked out, Freeman said. He was speaking for Herbert F. Mayer, president of the Empire Coil company of New Rochelle, N. Y., of which Freeman is vice president.

PUBLIC INTEREST in the advent of television in Portland proved a stimulant to the whole industry.

UHF in Portland - How is it doing?

Here is the first comprehensive report on the performance and coverage of KPTV - world's first commercial UHF television station

How is UHF working out in Portland? To find out I spent the first five days after the station went on the air driving around Portland and the surrounding countryside in a field survey truck. With a calibrated receiver operating continuously—and a field intensity meter for spot checking—we covered almost every street in Portland, and the roads for 40 miles in every direction. Having thus had an opportunity to evaluate the performance from the strictly technical viewpoint I spent three more days talking to broadcasters, distributors, dealers, servicemen—even the people who came up to our truck on the street—to find out what others thought about the performance of KPTV. In particular I tried to find out what success dealers and servicemen were having with their installations: where they were getting good pictures and where they found poor or no reception. I felt that by correlating their experience with our measured

FCC Approves Start of TV Programs Saturday

Story Column 8

Teacher Talk

These confining comments written on 10-10-11 cards

The Oregonian

Weather Forecast

Portland—Fair.
Oregon—Sunny, night and morning fog.
Wednesday temperatures—Maximum 65, minimum 51.

Start of TV Due Saturday For Portland

BY WILLIAM LAMBERT

Portland's first television station will go on the air Saturday with its first approval from the FCC and if its transmission picture. Herbert Mayer, president of Empire Coil, revealed his plans for application filed Monday.

Two TV Firsts Due Portland

Portlanders who own television sets will have their first look at a new week end.

Television Control Room Ready

KPTV Signal Starts in City

Test Signal Airing Due Thursday

Regular Schedule For Initial Station Seen by October 1

BY WILLIAM LAMBERT
Portland, Ore. (The Oregonian)—The federal communications commission Wednesday approved the application for KPTV in its handling race to give Portland residents their first look at television.

UHF Television Enters Portland



In a studio at the KPTV control building, Herbert Mayer, president of Empire Coil company, is shown Saturday as he pushed the switch which put his voice on Portland's first television show. A small Alex elephant, which appeared to be the TV trademark for Portland, was also in the first act.

BY HERB PENNY

In a gala burst of party atmosphere, speeches and mutual relations on the back television screen at Portland

TV Bow Here Rated Success

BY HERB PENNY

In a gala burst of party atmosphere, speeches and mutual relations on the back television screen at Portland's first commercial ultra high frequency TV program ever shown in the world. Master of ceremonies for the milestone event was smiling Herbert Mayer, president of the Empire Coil company, which built KPTV, the city's first television station, atop Counselor Crest. In many locations the first programs came in with good clarity, although there were some reports of receivers that "showed" nothing but "snow." Many sets in the city were unable to receive the program as the sets had not been converted to UHF.

Above is view of transmitter and its control room. Foreground is first UHF television station in country.



Portland's first television Thursday, Number "27" in center is station's ultra high frequency range. Slogan at lower "World on View." First program will be Saturday.

Nation Eyes UHF Video In Portland

RCA Plans Branch To Distribute Data On TV Set Service

TV's Here Turn Knob At 4:30 P.M.

Weird-looking antenna devices that will bring television into Portland homes for the first time were cropping up on rooftops all over the city today as station KPTV prepared for its first scheduled broadcast. The ultra-high frequency outlet, first in the nation, was scheduled to begin broadcasting at 4:30 p. m. The first half-hour show was arranged

Portland, the only major city in the nation without television service, has the unique TV set service development. The two top officials of RCA, John B. Thomson, vice president of RCA Video Service, Inc., announced the opening of a new RCA service branch to be set up in the near future. The initial, according to Thomson, will be extended into Portland homes for the first time were cropping up on rooftops all over the city today as station KPTV prepared for its first scheduled broadcast. The ultra-high frequency outlet, first in the nation, was scheduled to begin broadcasting at 4:30 p. m. The first half-hour show was arranged

SUCCESS OF UHF was guaranteed by the enthusiasm with which the public bought receivers.

A Detailed On-the-Scene Report
Written Especially for BROADCAST NEWS
by JOHN P. TAYLOR
Manager, Advertising Section
RCA Engineering Products Department

data it would be possible to predict the ultimate coverage of the station even though only a relatively few sets were yet in operation.

A Quick Summary

What did I find out? The whole story is told in detail in the following pages. However, for those who cant wait here's a quick summary.

(a) In general the performance of KPTV has been such as to startle the industry. Most of the experienced radio men investigating it in person have

agreed that it is "much better than expected".

(b) More specifically, KPTV is delivering Class A coverage (74 dbu) to about 20 miles in all direction where there is population, and Class B coverage (64 dbu) to 30 or more miles in the directions where there is favorable terrain.

(c) Although there are local "dead spots" the total population in these areas is probably less than 5% of that in the city proper, and less than 12% of that in the whole trading area.

(d) Required antenna installations are no more complex than for VHF and are easily handled by servicemen with even slight experience.

(e) Lack of sufficient good UHF receivers, and difficulties with makeshift UHF conversions, have caused some trouble. Most of this, however, is attributed to inadequate deliveries on the part of some manufacturers. It is felt that these difficulties will be largely cleared in a matter of weeks.

(f) The wholesale and retail trade people in the Portland area are, for the most part, very happy with the performance of KPTV. More important, they are selling sets as fast as they can get them.

(g) There are a number of things which prospective UHF telecasters can learn from Portland. To that end we recommend that they read the detailed story on the following pages.

The Background—Where UHF Television Stood After Bridgeport

Probably there is no one in the television industry who is not familiar with RCA's three-year, three-million dollar experiment in UHF at Bridgeport. KC2XAK, an experimental UHF television broadcasting station was constructed by RCA and NBC in 1949 and operated continually from then until August 23 of this year. During this period the signals of KC2XAK were used for propagation studies and for intensive testing of UHF transmitting equipment, UHF antennas and UHF receivers, not only by RCA but by nearly all of the major manufacturers of receivers. It might be assumed that such a comprehensive field test would have answered almost all of the questions about UHF. As a matter of fact

it did answer most of the major questions. It proved that UHF television broadcasting was feasible and practical. And it showed that UHF transmitters and UHF receivers, although less fully perfected than VHF units, could be built without too much difficulty.

However, there were some questions which Bridgeport did not answer fully. One of these was the question of how big an area UHF would cover. Because the terrain around Bridgeport was so hilly KC2XAK's signals were attenuated rapidly in most directions. As a result it was difficult to be sure how far the signal would go in favorable terrain.

The relative importance of transmitting antenna height was another question not

determined at Bridgeport. It is obvious from the quasi-optical properties of UHF that height is of great advantage. However, at Bridgeport the transmitting antenna height above average terrain—even in the most favorable directions—was only three hundred feet. The question of what UHF transmitting antennas a thousand feet or more high would do remained unanswered.

Finally, there were the questions which the lack of sale of receivers to the public left unanswered. Would the public buy UHF receivers? Would they accept "converters"? Would UHF receiving antennas of simple types be satisfactory for home use? Would servicemen take extra pains to make UHF installations work? In other words, even though UHF was technically feasible, would it work out in every-day practice? These were "non-technical" questions which only a commercial installation would answer.

What Is So Different At Portland?

The KPTV installation at Portland differs from that at Bridgeport in three important respects. The first two of these are technical. They are:

- (1) The transmitting antenna at KPTV is 1000 feet above average terrain in most directions. Thus the transmitter figuratively "looks down the chimney" of almost every home in Portland.
- (2) The terrain, at least in the directions of maximum population, is relatively flat. Thus a large proportion of the receiving antennas will receive line-of-sight transmission.

That these two conditions would make for better coverage than at Bridgeport was obvious. How much difference they would make was the question.

The third important difference in Portland is a commercial one. At Bridgeport no attempt was made to promote UHF, relatively few receivers were in use, and most of them were installed by factory-trained technicians. Thus Bridgeport was in no way a test of public acceptance, nor even a conclusive test as to just how well UHF receivers would perform in average home installations.

At Portland UHF is receiving tremendous promotion (most of it self-generated by public interest). The city has had little TV before (only occasional reception of KING, Seattle, 130 miles away) and is literally in a frenzy to get TV at any price. As a result there will be no difficulty in building an audience if the technical performance is satisfactory.

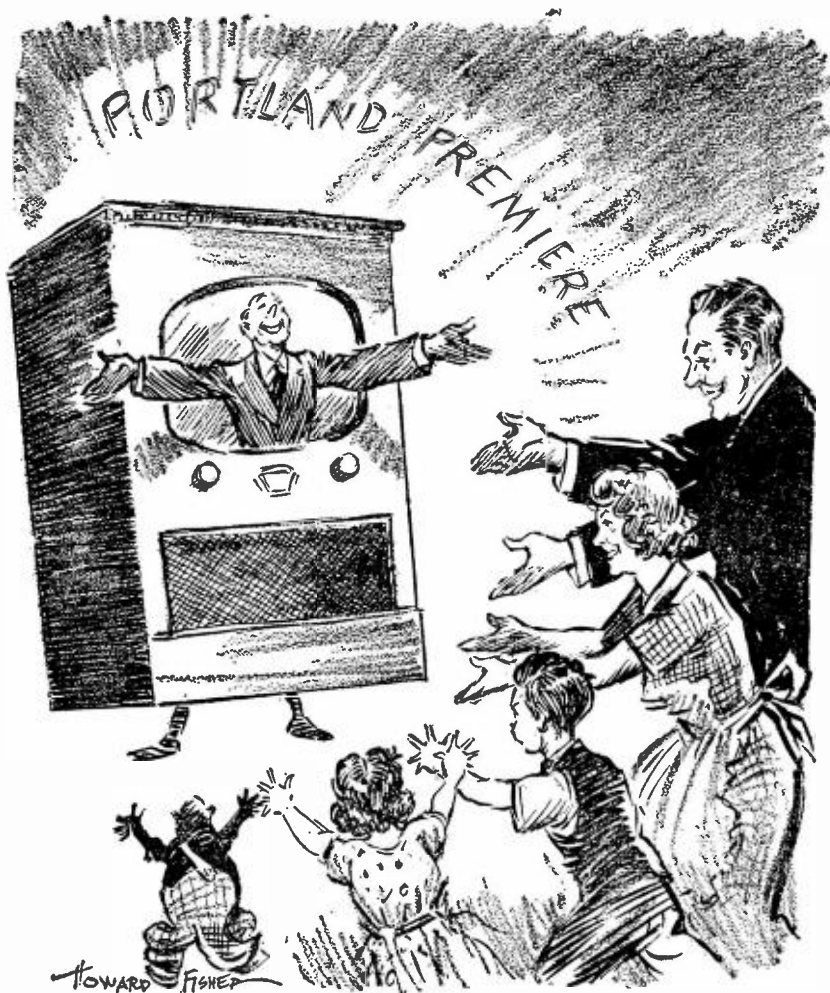

'HOWDY, STRANGER!'

FIG. 1. Television-starved Portland greeted KPTV's inaugural with unbounded enthusiasm. The stampede to buy receivers guaranteed that UHF would get an immediate and fair test without the necessity of bucking the "listening habits" which prevail in "old TV" areas.

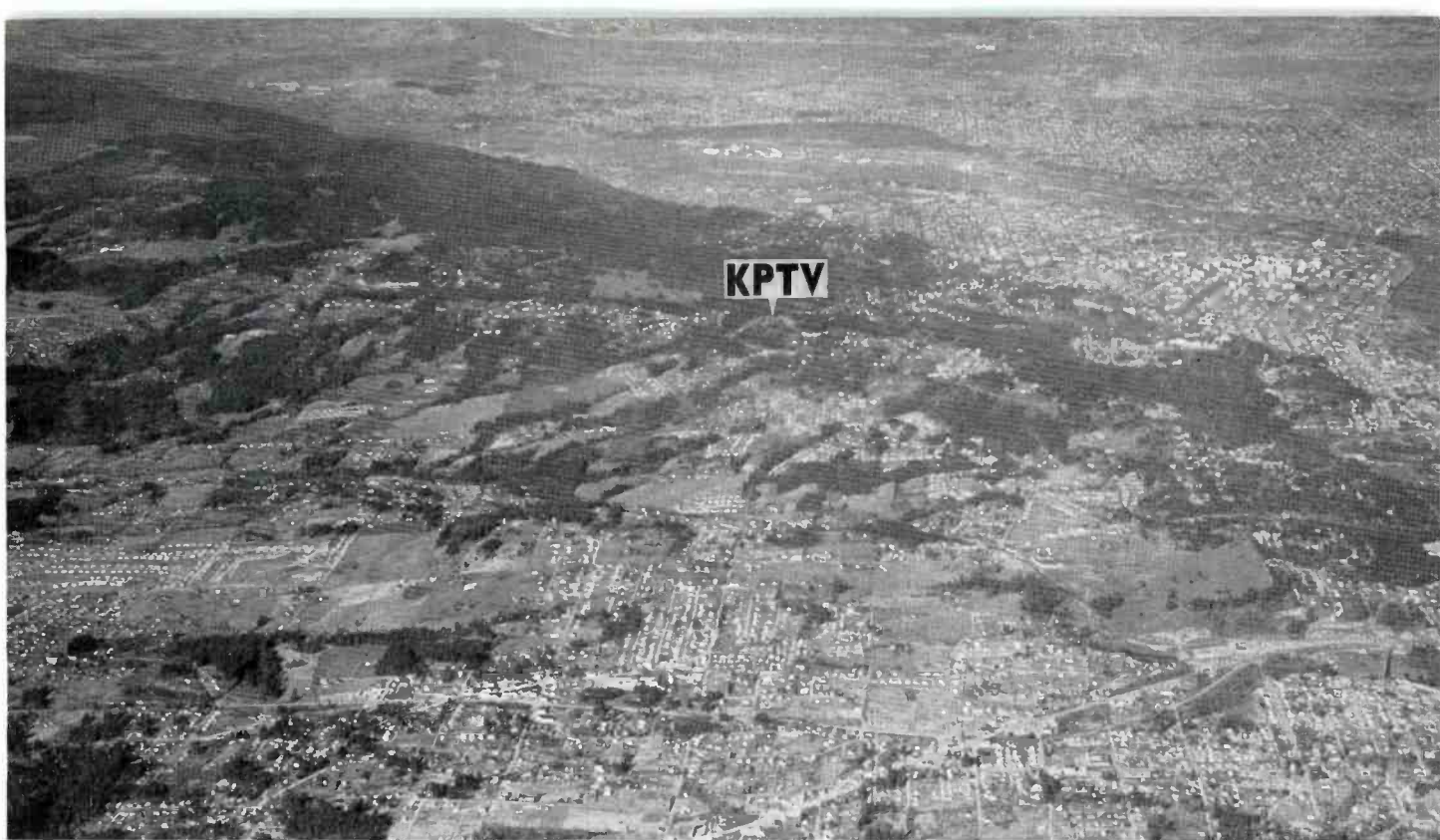

FIG. 2. This aerial view shows the favorable location of KPTV's transmitter. The 1000-foot ridge on which it is located is only two miles from the main business district of the city, which is in the upper right corner of this picture. The fact that the KPTV antenna can be seen from the roof of almost every house in Portland is a great advantage.

Receiver performance, of course, depends not only on the equipment available but also proper installation and maintenance. The lack of experienced servicemen in a new market like Portland therefore is an important consideration, not only for the station owner but for the manufacturer. As one example of how the need is being met, the RCA Service Company is conducting a series of educational clinics, patterned after the instruction courses for its own technicians, which are open to all servicemen in the area.

Why Is Portland So Important?

Someone may ask, "Why all the fuss about Portland?" But it is not likely to be either manufacturers or broadcasters. The receiver manufacturers have a tremendous interest in this operation, not only because it offers an ideal proving ground for their product, but also because it will be the first real answer to the question of how well UHF receivers will sell.

Broadcasters, or at least a lot of them, have an even more cogent interest. This follows from the simple fact that many station owners find themselves in a position where if they want to get into television at all they will have to take UHF. Television, whether UHF or VHF, is expensive, and for some station owners it means investing most of the capital ac-

cumulated in a lifetime of AM operation. Naturally these broadcasters are a little hesitant to jump into UHF without some proof that it will pay off commercially. They hope to find at least part of the answer at Portland.

Those broadcasters who will, perforce, have to operate a UHF channel in competition with VHF channels are especially anxious to know how the UHF will compare. It will be some months before there is a VHF station operating in Portland, and hence a side-by-side comparison is not possible. However, enough is known about VHF propagation to predict coverage with some accuracy. Therefore, once the UHF coverage in Portland is determined it can be compared directly with a careful prediction of VHF coverage and some pretty good conclusions arrived at.

Broadcasters in "UHF only" areas have a simpler but equally intense interest in Portland. In their case it is simply a question of—will it cover the trading area? Portland is a larger city than most of the "UHF-only" cities. Therefore, if KPTV does a good job of covering the Portland area it would seem to be safe to conclude that it will satisfactorily cover any of the others which have equally favorable terrain.

Both "UHF-VHF" and "UHF-only" prospects have a further, and common, in-

terest in the Portland installation. This is the question of power—especially the starting power. The Commission rules allow powers up to 1000 kw ERP for UHF. However, the indications are that high power UHF transmitters will not be available for some time. There are two questions, therefore: (1) What power is needed ultimately? (2) What power is safe to start with? Transmitters of 1 kw output (meaning ERP's of up to 25 kw) will soon be available in quantity. Quite a few stations are planning to start with this power. However, some have been hesitating, apparently feeling that the signal strength would not be adequate and perhaps would give UHF a bad start. Because KPTV has a 1-kw transmitter, and is in all major respects similar to what most stations would start with, it should furnish an answer to this question.

What Is the Best Way of Measuring Performance?

Because of the widespread interest in the KPTV installation we felt that we could render an important service to the industry by providing an early report on the performance of the station. Performance, of course, means different things to different people. The engineer measures performance by arbitrary units of output power or field strength. The artist judges

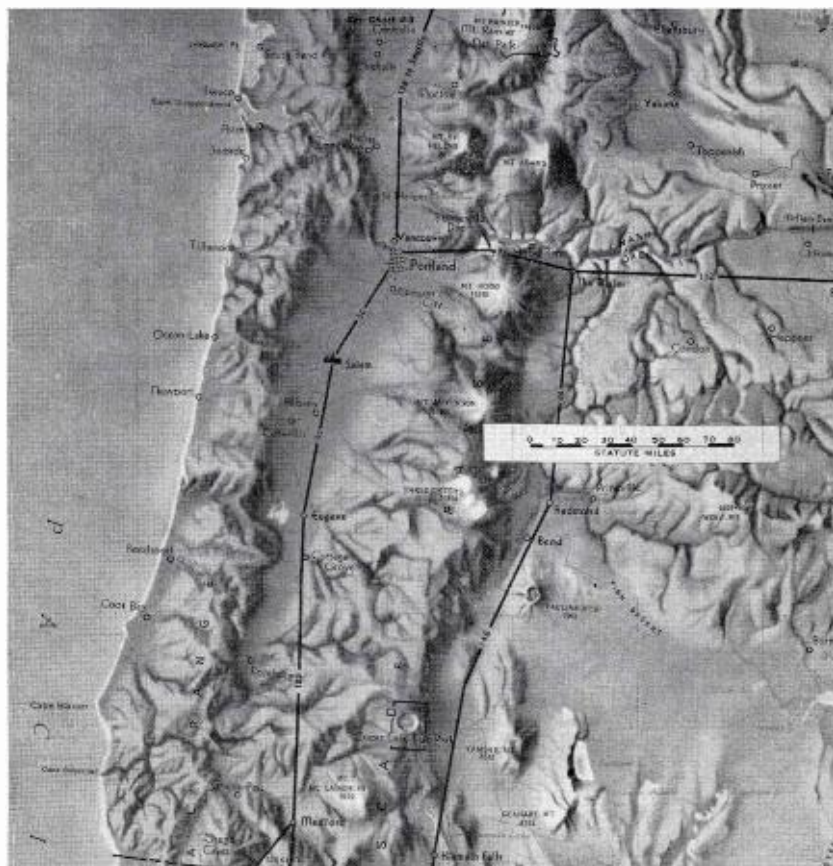

FIG. 3 (left). This topographical map shows how Portland is situated in a 50-mile wide valley between two high mountain ranges. These mountains limit KPTV's coverage to about 20 miles in the east and west directions. From the scales viewpoint this is unimportant because there is little or no population beyond the first foothills.

FIG. 4 (right). This is an aerial view of part of Portland, looking east from a point approximately over the KPTV antenna. Note that the area within the city proper is quite flat. Just beyond the city limits is an area of scattered small hills. However, there is just a sprinkling of population beyond these so that such "shadowing" as does occur is relatively unimportant.

it by quality of reproduction. The station manager or owner, however, measures it simply by how big an audience it will provide. It is this latter measure that we are most interested in right now.

How can you determine the size of the potential audience? In the case of an established station it can be done by phone, mail or door-to-door canvass. However, for a new station this method will not work for the simple reason that there are not enough receivers installed.

At first, we had hoped that we might approach the problem by a somewhat similar but less direct method. We felt that if all of the installations made by our own RCA Service Company were plotted on a map (with "good" and "poor" reception noted) we would be able to mark out general areas of good and poor reception. From this map we could then project the total potential audience.

We quickly found this would not work. To begin with, there were not enough installations. Then too, a large proportion of the installations that had been made were in dealers' stores and could not be

considered typical installations. Finally, not a few installations had been made when there was no signal on the air, so that no attempt was made to find the best antenna location. By the time all of the "non-typical" installations had been eliminated there were left only enough points to give a vague idea of the areas of good reception. Some other method, therefore, had to be used.

How Did We Go About Measuring Performance?

Since there were not enough installations to measure audience by a direct count we had to find some less direct method which would, nevertheless, give the same kind of answer. After some experimentation, we decided on a method which combines quasi-engineering techniques with commercial judgment. Probably neither engineers nor commercial people will be entirely happy with it. However, we believe that within practical limits of error it gives the kind of answer we are looking for. This method involves five steps:

(1) To find out "how far the signal goes" by making an approximately determination of the field strength contours.

- (2) To determine "how much signal is needed for good reception" by measuring the signal level at points of minimum satisfactory reception.
- (3) To locate and chart "areas of poor or no reception" (due to shadowing) by means of field intensity measurements, visual observation, study of shadowgraphs and check of servicemen's reports.
- (4) To draw a map (from the above information) showing the outer limits of good reception and the dead spots within the area.
- (5) To determine from this map the approximate percentage of homes (in the trading area) which can be expected to receive good pictures and, therefore, represent the potential audience.

How Far Does the Signal Go?

In estimating UHF signal coverage the effect of terrain is a major consideration. A radiated power which provides a good picture at locations 40 miles away over favorable terrain (i.e., nearly flat) may not give a usable picture in a deep valley



or gorge only half a mile from the transmitter in another direction. Thus the methods used in AM broadcasting, i.e., of drawing minimum field intensity contours and assuming that everything within them is adequately covered, will not work for UHF. Alternative methods have not been standardized. However, we decided that if we first determined the outer limits of coverage under good conditions, then came back and determined the dead spots, we could, by subtraction, arrive at a good answer.

The city of Portland lies in a 50-mile wide valley between two mountain ranges (see map, Fig. 3). The center part of the valley is relatively flat but is dotted by small hills averaging three hundred feet in height. In addition there are several ridges of the order of one thousand feet high. One of the latter is on the west side of Portland (within the city limits) and it is on this crest that the KPTV transmitter is located. The transmitter site, as may be seen in Fig. 2, dominates the city and most of the surrounding countryside. Fortunately, most of the population resides in the flattest and most favorable directions from the transmitter.

In order to get an idea of the signal strength over the area we made measurements along four radials from the transmitter, approximately north, east, south and west. The field truck used is shown in Fig. 5 and is described in the caption of this illustration. Since we were primarily interested in the commercial value of the signal we used a corner reflector antenna (Fig. 7) and made most of our measurements with this antenna at a height of 30 feet. This corresponds to a good home installation in the Portland area (this point is further discussed below).

With an antenna at 30 feet it is not practical to make continuous recordings while running along city streets (nor even most roads) because of the number of overhead wires. On the other hand, single spot measurements at fixed points do not give a good indication because the signal may vary widely within just a few feet (due purely to local effects). As a compromise we made "area checks" in the following manner:

(1) At intervals of a few miles along each radial we selected locations which seemed to be "in the clear" in that

they were not immediately shadowed by hills, tree clumps or large buildings. These locations were not hilltops and were not necessarily "line of sight". However, neither were they in valleys or sharp dips.

- (2) At each location we raised our antenna to 30 feet, oriented it on the transmitter and set the field intensity meter. We then drove slowly along the street (or road) for about 100 feet, noting the fluctuations of the field intensity meter.
- (3) In each case we recorded the maximum, minimum and "average" meter readings. We decided, however, to use only the maximum readings. On this point we may be challenged, hence an explanation is in order. Our decision was based on the behavior of the meter during the 100-foot runs. We noted that on most of our 100-foot runs the meter tended to read near the maximum for most of the time. The sharp variations were nearly all in the downward direction and usually occurred for only a foot or two of travel. Thus we reasoned that the maximum signal (or very near it) could



FIG. 5 (left). This is the RCA Service Company's field truck which was used in making the observations on which this report is based. The antenna on the extension tower can be raised to any desired height between 20 feet and 70 feet. For field intensity measurements this antenna was connected to a Stoddard Field Intensity Meter mounted at the observer's position in the truck. The bow tie antenna near the front of the truck was connected to an RCA U-70 Selector feeding into an RCA 630 TV Receiver. Both receiver and field intensity meter were supplied 110 volt power by a small gas engine generator in the truck and could be operated with the truck in motion. The equipment for this field truck was planned and installed by J. D. Callaghan and A. I. Kothe of the Engineering Section of the RCA Service Company. The truck is a part of the permanent equipment of the RCA Service Company's Portland branch. It will be used by technicians in determining the best locations for difficult antenna installations.

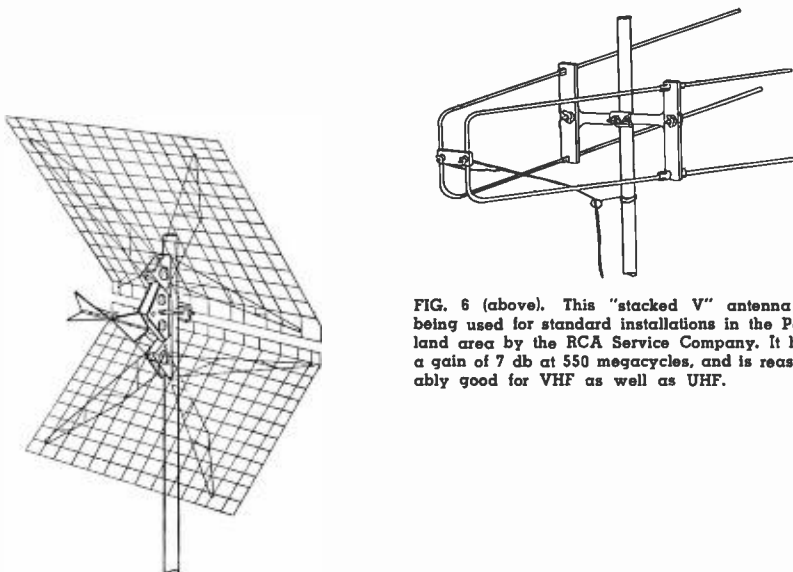

FIG. 6 (above). This "stacked V" antenna is being used for standard installations in the Portland area by the RCA Service Company. It has a gain of 7 db at 550 megacycles, and is reasonably good for VHF as well as UHF.

FIG. 7 (left). This is a "corner reflector" antenna of the type used on the truck. This antenna, which has a gain of 9 db at 550 megacycles is used by the RCA Service Company in "difficult" installations.

be obtained on every rooftop in the vicinity, provided that the installer was willing (where necessary) to move a few feet along the ridge of the roof to find it. In the Portland area we feel sure that they will do this (although in an "old TV" area they might not).

Along each radial we made six to ten such measurements. Here again, the engineers may question our procedure, saying that this number is not enough. Our answer is simply that we were not making an engineering survey but only enough measurements to establish the general signal levels to our own satisfaction.

It is true that when plotted radial by radial this is hardly enough points to establish a curve. We have, therefore, plotted all of the points from the four curves on one graph (Fig. 8). Since the general elevations in all directions are comparable this seems legitimate. It will be noted that for this type of measurement the separate points are reasonably well grouped.

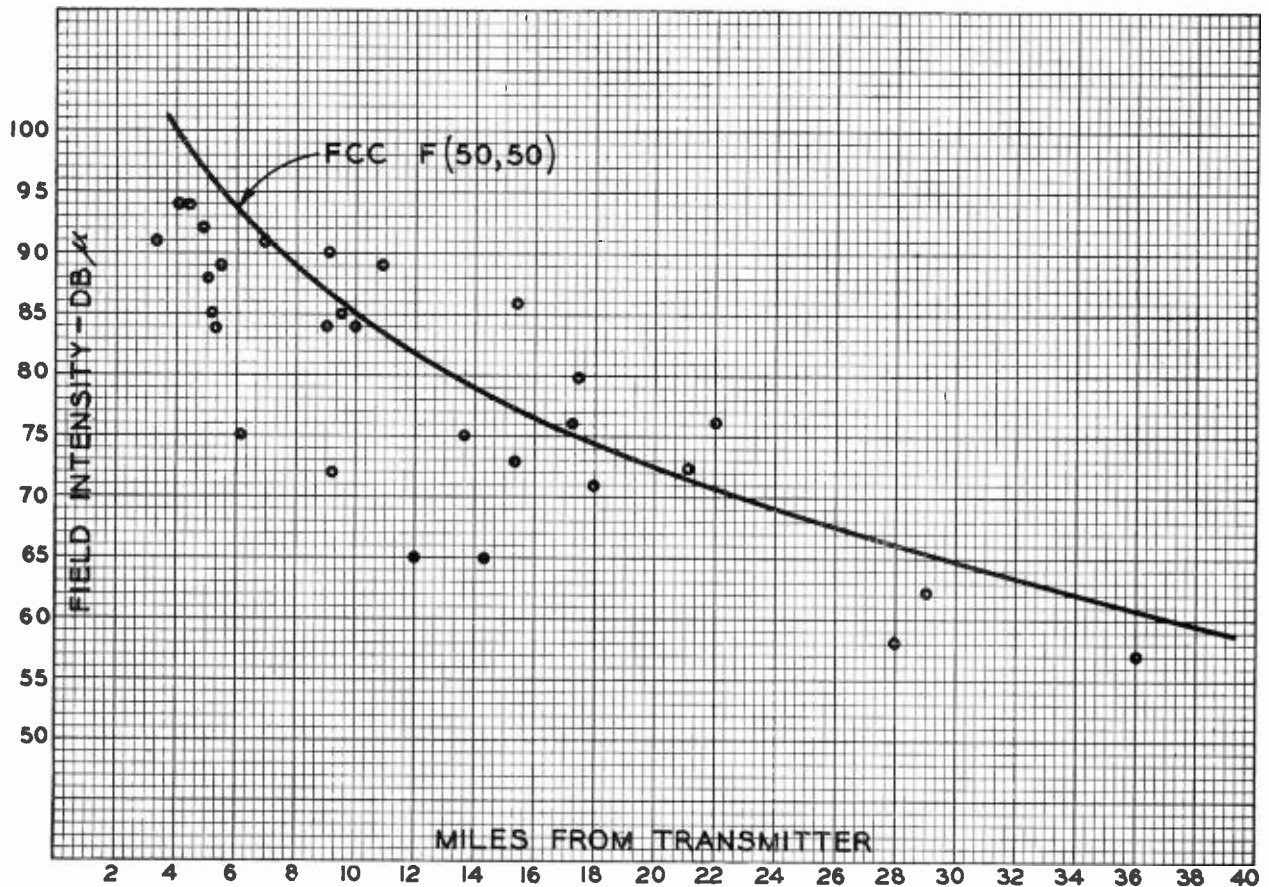

FIG. 8. The circles on this graph represent field intensities measured at various distances from the transmitter along four radials. The four low points between 6 and 14 miles are believed to have been made at below line of sight locations. The solid curve is the F(50,50) curve for 16 KW ERP and 1000 feet above average terrain from the FCC Sixth Report and Order. It coincides quite well with the average of field intensities measured in this survey.

On this same graph we have plotted the FCC's F(50,50) curve for an antenna 1000 feet above average terrain and an ERP of 16 kw. Although the method of measurement is not the same as contemplated by the FCC, the correlation is interesting. It is also useful since it means that (at least for this frequency and antenna height) the available curves may be used as an indication of expected signal levels.

Although this conclusion is not rigorously justified, we feel that for our purposes it is sufficiently supported. In all of our further discussion, therefore, we will use the solid curve of Fig. 8 as our indicator of general coverage.

How Much Signal Is Needed For Good Reception?

Theoretically it should be possible to determine in the laboratory the signal level necessary for good pictures. In practice, however, several variables enter which cannot be measured in the laboratory. First, there is the broad question of what is a

"good" picture. This varies not only with the observer and his relative location but also according to the competitive situation (how many other signals, how good, etc.). Second, there is the effect of receiver antenna location, care in installation, etc. The question here is, how hard will the installer work to get a good picture? In the present instance there is still a third open question. This is, how good are the average receivers—not just a selected set tuned-up for lab measurement, but the regular run-of-the-mill sets as actually installed in the customer's home? Also, how good are the sets of other manufacturers, and in the case of UHF, how good are the converters?

In a "new TV" area like Portland the standards of picture quality are much lower than in "old TV" areas. People are so hungry for television that they are enthralled with anything that looks like a picture. In one dealer's shop (in an outlying town) we saw a picture that was "half-snow". Yet people were buying sets like hotcakes on the strength of this picture.

The signal level where this "half-snow" picture was being received was less than 1 millivolt/meter (60 dbu). This probably defines the very outer level of usable signal level. However, such a picture cannot be considered satisfactory for ordinary purposes. We found at Portland that the limitation on reception was the "snow" caused by the noise level in the input circuits of the receiver (or converter). Outside of the "tall building" area we found very little difficulty due to multi-path, and at no time did we see anything that looked like noise-type interference. There was occasional very light "herringbone", due presumably to FM station interference. And in some makes of receivers there were a few reports of taxicab and police station interference. However, both occurred most often in areas of high signal level and, therefore, are not related to the signal level necessary for good pictures.

On the basis of the above we decided to define our "good picture" as one which just "broke the snow", i.e., the level just

THE WEATHER
 FAIR TONIGHT and Friday.
 Little or no rain tonight, 41,
 high Friday, 55.

Capital Journal

HOME EDITION

64th Year, No. 224 Salem, Oregon, Thursday, September 18, 1952 (40 Pages) Price 5c

Tests Proved Sick UHF Television Neg Clear in Salem Gov

Set Owners to See World Series, KPTV on Air Saturday

By STEPHEN A. STONE

Rainy weather of television sets will see and hear the 1952 world series baseball games. They will be able to see the big football games this fall, and all other programs and events that are scheduled to be telecast.

Salem dealers who had said that Portland's new ultra high frequency station, KPTV, would up all of last night, or that the right of hand, as that both were made of the Portland station on a Council Crest.

William Hertz Radio-Television, which means they were successful. True, it was really a test pattern that was causing concern that was in clearly brought to them that it proved the case for Salem. The pattern just seemed much better at Salem.

The pattern has an average of 1.5 mv/m (64 dbu) to 2.5 mv/m (68 dbu).



William Hertz Radio-Television Co. in Salem—The one picture that came last night and today to Salem television sets. Frequency television can be seen clearly in Salem.

Local Paragraphs

Ankle injured—First aid was given Norman Smith, 1604 Hickory street, Wednesday, who fell while watching construction of a house in the 300 block on the Jan Heights avenue. The work was later resumed.

Regina in Nondulato—Williamette Acacia 2081 of the Fraternal Order of Eagles will hold next president and chaplain on Tuesday, September 23. Members of the order will meet at 7:30 p.m.

Tests Proved

(Continued from Page 1)

What makes the Salem dealers and set owners especially happy is that tests of last night today prove that the ultra high frequency (UHF) of Portland's Channel 27 will be clear and strong. Salem dealers had been told that it would be more than 18 or so miles out of Portland.

Some of the reasons were merely that it came last night and today to Salem television sets. Frequency television can be seen clearly in Salem.

Results of Salem tests last night and today are particularly significant because the Portland station is now operating at only one-fifth of the power it will have in the near future. It is now running on 17.5 kilowatts, but will later operate at 60 kilowatts. The KPTV tower stands 1200 feet above sea level. The KPTV tower stands 1200 feet high with a 100-foot extension above that. A 100-foot extension above that. A 100-foot extension above that.



Rains—Employees of the High Experimental Company at Independence Thursday evening were clearing away debris of new foundry that burned Wednesday night causing a loss of \$75,000. Origin of fire is unknown. Plans already are being made to erect a new fire-proof foundry.

Like Hammers Finger Ridge Recaptured by Push-Button Warfare for

Capital Journal, 18

New Ho. Independen

Independence, 18

Monday of the 18th of September, 1952, the Independence of the United States is celebrated. The Independence of the United States is celebrated on this day. The Independence of the United States is celebrated on this day.

The plant was destroyed by the local machinery and new machinery in the form of the Independence of the United States. The plant was destroyed by the local machinery and new machinery in the form of the Independence of the United States.

Ronald Blumberg, plant manager, said that the fire was caused by a fire in the boiler room. The fire was caused by a fire in the boiler room. The fire was caused by a fire in the boiler room.

Plans for the new plant are being made. The plans for the new plant are being made. The plans for the new plant are being made.

APR. 18, 1952 (AP) New York (AP) 18

FIG. 9. Opinions as to what constitutes a "good" picture vary considerably and may depend on local conditions. The KPTV picture in Salem (40 miles away) was considered satisfactory by many, as the above clipping indicates. Although it had considerable "snow" in it, dealers were selling sets like hot cakes on the strength of this picture.

barely above that at which snow was evident in the test pattern. This is a fairly rigorous test, in that snow which is just visible in a fixed test pattern is not ordinarily perceivable with action pictures.

Having defined our "good picture" we next set about to measure the signal level necessary to provide it. Our procedure was to connect our corner reflector antenna on the truck to our receiving setup, which consisted of a U-70 Selector feeding a Model 630 Receiver. The antenna was turned away from the transmitter until "snow" appeared in the picture. Then the antenna was turned back until the "snow" just barely disappeared. At this point the lead-in was removed from the receiver, attached to the field intensity meter, and the signal level measured. This procedure was repeated a number of times, in both high and low signal level areas. The average of these measurements was just over 2 millivolts/meter (66 dbu). As a further check we looked at the pictures in a number of dealers' stores in outlying towns where the picture was either not quite "good" or just barely so. We either measured or estimated the signal levels at these points and found that they ran from 1.5 mv/m (64 dbu) to 2.5 mv/m (68 dbu).

Several engineers we have talked to have noted that we used a corner reflector antenna

at a height of 30 feet and have questioned whether this is not too good a setup to judge by. We think not! At the present time the RCA Service Company branch in Portland is using a "stacked V" type antenna (Fig. 6) on a 6-foot pole as a standard installation. The "stacked V" has only slightly less gain than a corner reflector, and mounting it 6 feet above the roof of an average house brings it pretty close to our 30-foot height. It is undoubtedly true that some installations will not be this good. However, we believe that the RCA Service Company installations will set the standard for the industry—and that most name installations will be comparable to our setup.

On this basis we concluded that a signal level of 2 mv/m (66 dbu) is a satisfactory measure of "good picture" coverage. This is very close to the FCC's requirement of 64 dbu (1.6 mv/m) for Class B coverage. Assuming that there will be some improvement in UHF receivers we feel that the 64 dbu figure will be satisfactory. Moreover, use of this figure will avoid confusion. Therefore, we have used 64 dbu as the "good picture" level in the rest of our discussion.

Mapping the Coverage of the Station

From the information developed above two KPTV "coverage" maps were drawn

up. The first of these (Fig. 10) shows the outer limits of the general coverage. The circle "A" has a radius of 20 miles, corresponding to a signal level of 5.0 millivolts/meter (74 dbu) as shown on the curve of Fig. 8. This is the "Class A" coverage as defined by the FCC. The circle "B" has a radius of 30 miles, corresponding to a signal level of 1.6 millivolts/meter (64 dbu) as shown in Fig. 8. This is the limit of "Class B" coverage as defined by the FCC, and as approximately confirmed by our observations. This circle indicates "how far the signal goes" under favorable conditions. However, a study of the terrain indicates that reception will not be good this far in all directions. In the east and west directions, for example, there are foot hills at about 20 miles which cut off the signal beyond. Actually this makes no difference, for there is little or no population beyond this point. Northward the signal follows the river valley until it is lost among the hills at about 25 miles. Southward the terrain is rather more favorable. In this direction reception is generally good nearly to Salem (40 miles). The signal in Salem is fair, and dealers there are doing a thriving business. However, technically it is slightly outside the good coverage area.

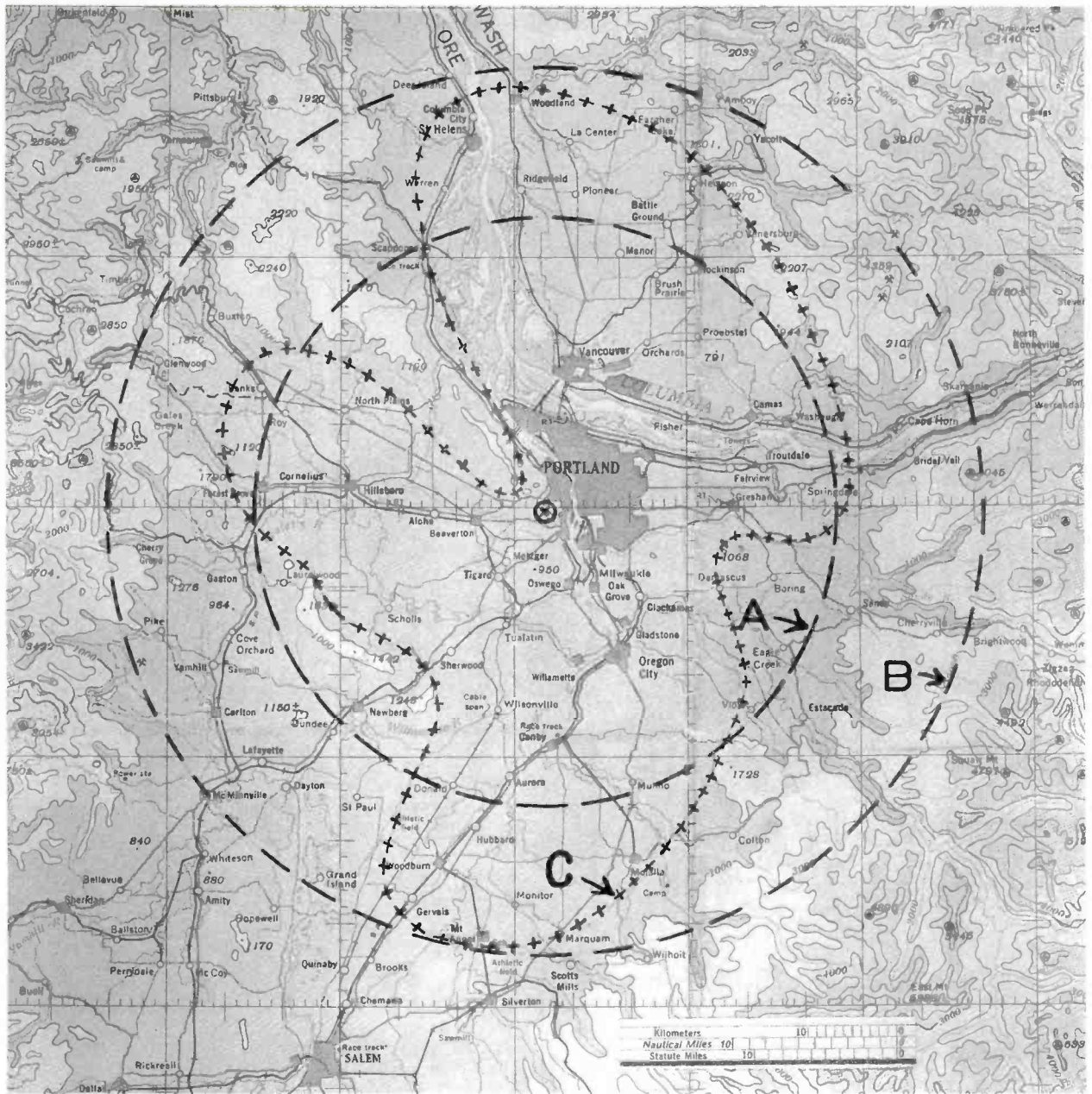

FIG. 10. The outer limits of the general coverage of KPTV are indicated on this map. The circle A has a radius of 20 miles, corresponding to a signal level of 5 millivolts/meter (74 dbu) as shown on the curve of Fig. 8. This is the Class A coverage area as defined by the FCC Sixth Report. The circle B has a radius of 30 miles, corresponding to a signal level of 1.6 millivolts/meter (64 dbu) as shown by the curve of Fig. 8. Curve B shows "how far the signal goes" assuming the whole area to be relatively smooth. Large obstacles of terrain will reduce this coverage in several directions. The curve C has been drawn as an estimate of the actual position of the 1.6 millivolts/meter (64 dbu) contour. The method of constructing this is explained in the text.

For the in-between directions we can judge the performance by major elements in the topography. Northwest the signal is shadowed by a continuation of the ridge the transmitter is located on. To the south-east is Mt. Scott, casting a narrow shadow.

To the southwest a high ridge is located at about 15 miles. Taking these into consideration we have made an estimate as to their effect and drawn a contour curve "C" as an indication of the approximate outer limits of coverage. This may seem like a very rough way of determining con-

tours. However, when it is considered that the population between curves "B" and "C" is probably less than 5% of that in the area bounded by "B", it will be obvious that the time required to make accurate measurements in these in-between directions would hardly be justified.



PORTLAND OREGON

CITY PLANNING COMMISSION

BARTHOLOMEW & ASSOCIATES
CITY PLAN & LANDSCAPE ENGINEERS
SAINT LOUIS - MISSOURI



FIG. 11 (left). Map of the city of Portland. Areas "A" to "F", enclosed in heavy lines, are areas of poor or no reception. Method of determining these is described below.

Location of Areas of Poor Reception

In order to determine what areas (within the general coverage area) were so shadowed by hills as to be in effect "dead spots" we used several methods. We started out by trying to locate and measure them by field intensity measurements. We soon found this to be so time-consuming as to be impractical. We next tried a visual method which consisted of watching the picture on our truck receiver while driving slowly along streets bordering dead areas. The antenna used in this case was only 10 feet high and hence was shadowed much of the time by houses and trees. However, we decided that if good pictures could be seen in the clear spaces between houses, then it was a fair assumption that an antenna on any roof along that street would get a good signal. On the other hand, if no picture was seen anywhere in the block, then we assumed that the whole block was in the dead spot. This method is relatively fast and, we believe, entirely satisfactory for the purpose. All the larger "poor reception" spots in KPTV's close-in area were roughly charted in this way.

The second "coverage" map, shown in Fig. 11, indicates the "dead spots" which were located as described above. Since the only ones which contain much population are those which are close-in, we have shown these on a large-scale map. It is interesting to study these in conjunction with the panoramic photograph of Fig. 12. Area "A" is due to the fact that the ridge where the transmitter is located is continuous in the northwest direction, with many ridges nearly as high as the transmitter. Thus reception in this direction is generally poor, although there are many points which are "in the clear" and enjoy good reception. On the side of this ridge toward the city there is a small residential area. In this area probably half the homes will be able to get fair reception.

The worst of the "dead" areas are those marked "B" and "C" on the map. The reason for these areas can be seen in the photograph. Between the high ridge on which the transmitter is located and the city is an intermediate ridge. This is not high enough to shadow much of the city. However, it has a very steep face toward the city and parts of this slope are in the shadow. Although the total number of houses on this slope is not great percentage-wise, this happens to be a fashionable

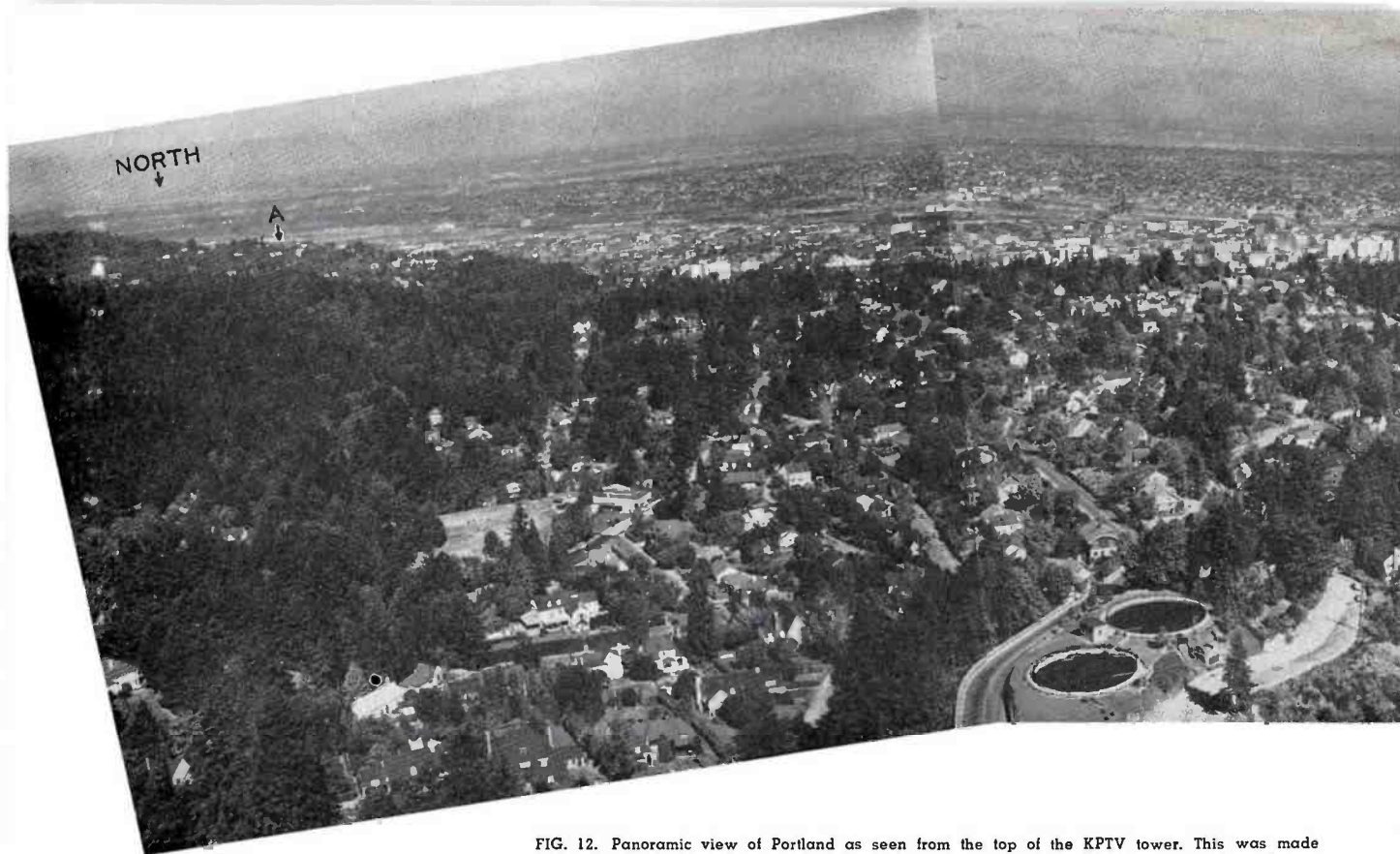

FIG. 12. Panoramic view of Portland as seen from the top of the KPTV tower. This was made by positioning together three separate photographs (roughly in the north, northeast and east directions). A series of eight such photographs provided a complete 360° view from the tower. These are very useful in determining which areas have line-of-sight reception. In the view above, the physical obstructions which cause the shadows on the map of Fig. 11 are indicated by the

residential district and some difficulty can be expected. Fortunately these are people who probably will be willing to pay for special antenna installations (which in many cases will result in usable signals).

At the base of this same slope is a mixed residential and business area, part of which is also shadowed. Included here are some dealers' and distributors' locations, a fact which led to some early poor reports. Here again, though, the total population is not large.

Areas "D", "E" and "F" are shadows of small hills, known locally as Mt. Tabor, Rocky Butte and Kelly Butte. These hills are some 200 to 300 feet higher than the surrounding area. One of them, Rocky Butte, is shown plainly in the foreground of Fig. 16. We made an investigation of reception behind one of these hills (Mt. Tabor), and found that there was a very dead spot immediately behind it. However, this did not extend very far behind and at about a half mile beyond the hill the picture was good, although the signal strength was still well below that expected for this distance. Our general conclusion

from this was that at this distance (i.e., where normal field strength is relatively high) the UHF shadows are about half as long as the light shadows. Other observations confirm this as a rough general rule. However, the signal never comes back entirely. Thus when two or three high ridges or hills intervene between transmitter and receiver the signal is successively attenuated and drops to a low value.

For those who will try such surveys in the future we have a suggestion. Before you start, climb the tower and spend some time studying the area. By this means you will be able to narrow down your dead spot hunting to the areas you can't see. Almost as good is to have pictures made from the tower (like those in Fig. 12). Contour maps are helpful, but they are harder to interpret.

Another method useful in predicting dead spots is the so-called shadowgraph technique. This requires that a three-dimensional relief map or model be available. If a small light (such as a "grain-of-wheat" light) is placed at the location and correct relative height of the trans-

mitter antenna the areas on the map which are below line-of-sight will be shadowed. A photograph of the map with these shadows on it can be used for locating possible dead spots.

The shadowgraph of Fig. 13 is one of several made by Dick Pooley, Chief Engineer of KPOJ, and Tom Friedman, Chief Engineer of WXEL. KPOJ is an applicant for Channel 12 in Portland and has specified a site on Mt. Scott (which is at the very bottom righthand corner in Fig. 13). Shadowgraphs made with the small light at various locations are often valuable in picking the best of several sites. Similarly, by moving the light up and down to simulate various antenna heights, it is possible to determine the best height relative to cost considerations.

At Portland we did not know about the existence of such a relief model until after we had completed the surveys described above. Therefore, when we did learn about it and obtained the shadowgraph shown in Fig. 13, it was as a check on our otherwise completed survey. Although we made a few minor changes after studying this shadowgraph, in general it merely confirmed



lettered arrows. Thus "A", "B" and "C" are secondary ridges which lie between the main ridge on which the transmitter is located and the city. They cause the shadows "A", "B" and "C" on the map. "D" is Mt. Tabor, "E" is Rocky Butte, and "F" is Kelly Butte. They cause shadows "D", "E" and "F", respectively, on the map.

what we already knew. Thus we feel that although the shadowgraph method is very useful and should be used wherever such a map is available, it is not a necessity and probably does not justify construction of a model just for the purpose.

Determining Percentage of Population Receiving Good Service

"Dead spots" are important only insofar as they contain population. A count of the population in these spots therefore is necessary in evaluating the coverage of the station. At Portland we were fortunate in that a "population distribution" map was available from the City Planning Commission. By plotting our dead spots on this map, as shown in Fig. 14, we were able to determine accurately the number of people residing in each area. These were as follows:

<i>People Living in Shaded Areas</i>	
<i>Within City Limits</i>	
Area A	9,840
Area B	3,120
Area C	6,200
Area D	3,320
Total	22,480

People Living in Shaded Areas Outside the City Limits

Area E	3,040
Area F	1,600

The total population of 22,480 in the areas A, B, C, and D is about 6% of the total population of 383,700 within the city limits of Portland. However, we know that a considerable number of homes in these areas will be able to get good signals because they are located on local high points. The shadowgraph (Fig. 13) shows the existence of many such points, particularly in that part of Area A which is the most populated. We believe that possibly one-third of the homes in Areas A, B, C and D will be able to get good reception in this way. This would reduce our "blind" population to 4%. But just to be safe we have called it 5%. That means that 95% of the 383,700 people living within the city limits of Portland will be able to enjoy good television with KPTV's present operating power.

What about the population outside the city limits? The recognized trading area of Portland includes Multnomah, Washington and Clackamas Counties in Oregon, and

Clark County, Washington. The total population of these counties is 739,400. That means 355,700 live outside the city limits. Most of them, however, reside in areas contiguous to the city.

In the time available it was not possible for us to investigate all of the possible dead spots outside the city. However, by studying the topographical maps of the area, and applying the knowledge of shadow effects gained in our detailed study of the city proper, we could make some pretty good guesses as to where there would be reception and where there would not be. For example, Mt. Scott, which is about eight miles southeast of the KPTV transmitter will certainly shadow everything in that direction. Fortunately, there is very little population behind it. Similarly, in the southwest direction there is a series of high hills about fifteen miles from the transmitter. These will probably shade all of the area in that general direction. This is somewhat more serious in that this area includes several small towns. Northwest, as noted before, there is a series of ridges run-



FIG. 13. This "shadowgraph" was made from a relief model in which all of the elevations around Portland were shown on a scale of 500 feet to the inch. A small surgical lamp was placed at the exact position and height of the KPTV antenna. High hills cast shadows which show up plainly in the photograph. The area in this photograph is the same as in the map on the opposite page. It will be noted that the poor reception areas on the map correspond with the shadowed areas in the photo above. However, the UHF reception "shadows" are only about one half as long as the light shadows.

ning for miles from the transmitter. However, there is no population at all in this direction.

If we were to add up the population in these shadowed areas it would probably amount to about 10% of the 355,700 outside the city. However, we know that in addition there are many small dead spots

due to low ridges, river valleys, and the like. We have guessed that another 10% of the population may reside in these areas. The remaining 80% of the 355,700 should be able to get good pictures with standard antenna installations.

If we add up the coverage figures in and out of the city it looks like this:

	Total Population	% Re- ceiving Good Pictures	No. Re- ceiving Good Pictures
In City ...	383,700	95%	364,500
Outside City	355,700	80%	284,600
Total in Trading Area	739,400	88%	649,100



FIG. 14. This is a "population distribution" map of the city of Portland. Each dot represents 40 people according to the 1950 census. "A", "B", "C", "D", "E" and "F" are the areas of poor or no reception, as determined by the method outlined on Pg. 13. By counting the dots in each of these areas it was possible to determine the percent population which will not be able to get good reception at the present time. With later increase in the power of the transmitter, and likely improvements in receivers, the size of these areas will be substantially reduced.

It is on this basis that we say that the present operation of KPTV will furnish good service to 88% of the population in the Portland trading area.

Comparison of UHF and VHF Coverage

Using the above figures we can make a very rough comparison of how the present

UHF coverage will compare with VHF when it comes.

We know that the VHF signal will "go further". There are two reasons: (1) the VHF signal is attenuated less by rough terrain, and (2) the VHF receivers will operate with signals of .5 millivolts/meter, whereas the UHF sets need 2.0 millivolts/meter.

Thus if we were to draw VHF coverage curves similar to the UHF coverage curves in Fig. 8 we would find the outer limits of coverage to be quite a bit further out. In some areas of the country this may make an important difference. However, at Portland we can discount this by noting that the UHF signal covers practically all the recognized trading area. Therefore, any

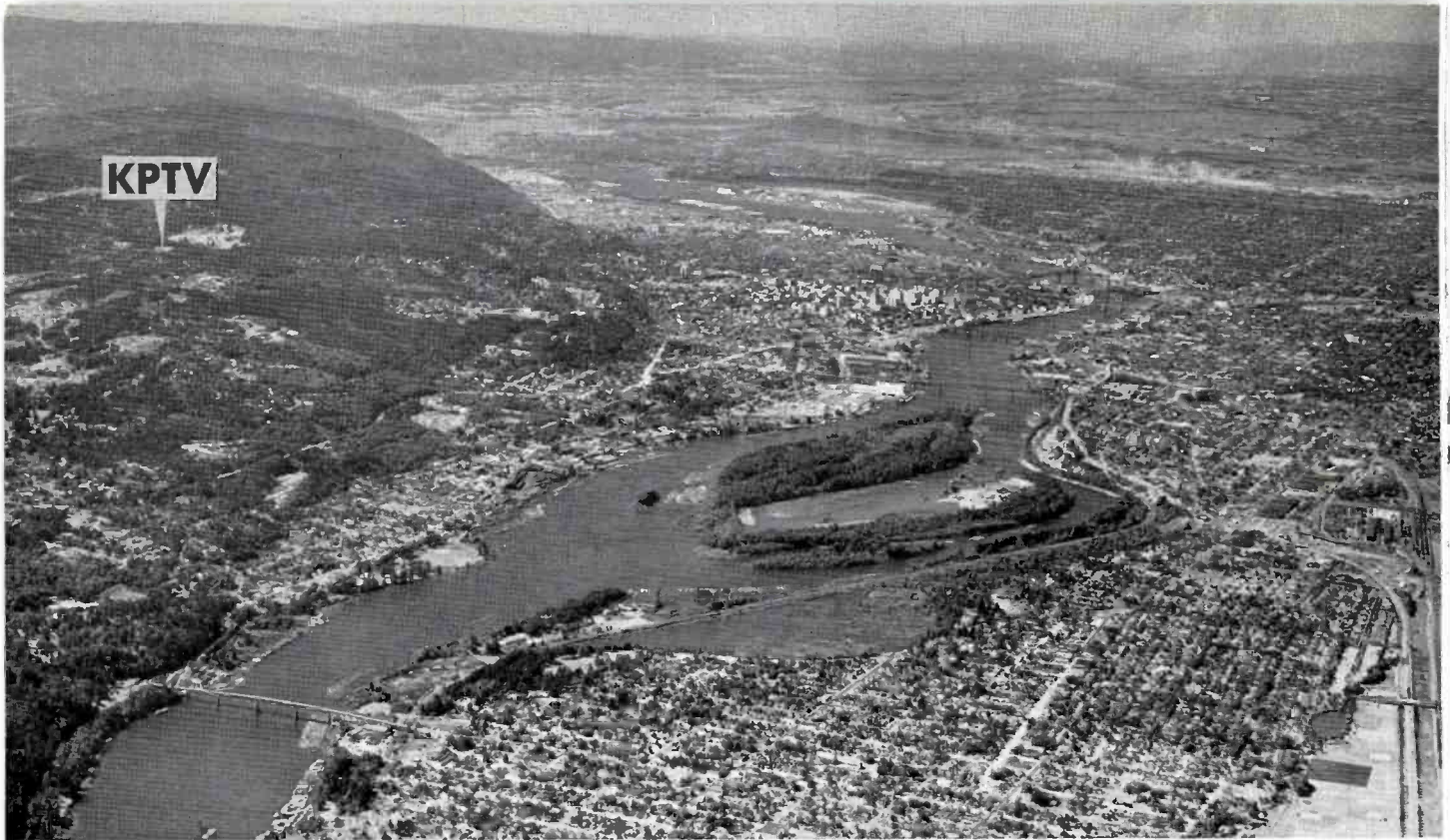

FIG. 15. This is an aerial view of Portland, looking northward from a point about six miles south of the business district which is located in the bend of the river at the center of the picture. The KPTV location is indicated by the arrow. Between it and the business district are some low secondary ridges which cause the shadows "A", "B" and "C" on the map of Fig. 11.

additional population picked up by the VHF signal is outside the trading area and not to be counted.

However, the fact that VHF signal will "fill-in" behind hills to a greater degree than UHF, will make considerable difference. How much we don't know with any certainty. Most of the shadow-casting hills are quite steep. It is fairly certain there will be VHF shadows behind them. These shadows will not be as long as the UHF shadows. Moreover, the greater sensitivity of the VHF receivers will tend to reduce the problem. However, there will still be some very poor reception areas. Suppose we assume that they are half as large as at UHF. This would mean that 94% of the population would get good reception of VHF signals. Then the final comparison would be:

UHF Coverage.....	88%
VHF Coverage.....	94%

These figures are first approximations but we feel that they give a general idea of the relative merits of UHF and VHF in the case of Portland.

The Question of How Much Power Should a UHF Station Have

Our survey at Portland did not give us a final answer as to the ultimate power

KPTV should have. The reason is that we do not know for sure what effect a given power increase will have on the signal strength in the shadows, and at distances well beyond the line of sight.

Although we made only a few field strength measurements in the dead spots, we did observe that at nearly all points in these areas there was a trace of picture on the receiver. Thus we are led to believe that there are signal levels of the order of 100 to 500 microvolts/meter even in the dead spots. If these signals will increase with transmitter power in the normal relation, then an increase in KPTV's transmitter power from its present 1 kw to 10 kw would greatly reduce the size of the close-in dead spots. From a competitive viewpoint this would be worthwhile even though the percent population gained would hardly seem commensurate.

The situation with regard to the fringe coverage is similar. For instance, in Salem (about 40 miles distant) KPTV presently lays down a signal of about 1 millivolt/meter (60 dbu). This is not enough to substantiate a claim of good coverage (even though it sells receivers). However, if this signal will go up with transmitter power in the normal way (and again we say "if"), then the increase to 10 kw will provide 3 millivolts/meter (70 dbu) at this loca-

tion. This would be a very adequate signal for this type of market. And in this case, too, the gain (from the competitive viewpoint) would be worth-while even though the population gain would amount to not more than 5%.

As we have noted, there are several big "ifs" in the above discussion of the effects of greater power. These make it impossible to give a flat answer. However, it is our feeling that in the long run KPTV will want an ERP of between 100 kw and 200 kw.

It should be noted, though, that this applies to Portland (and similar-sized cities) only. And it is mostly determined by competitive considerations (there will be 3 VHF's and one more UHF in Portland eventually). We believe that in many smaller communities power equivalent to that now used by KPTV will be sufficient.

Is a 1-KW Transmitter Large Enough to Start With?

This is an important question right now because 1-kw transmitters are available whereas higher power transmitters will not be ready in quantity for some time. We feel that at Portland we found the answer—and that answer is "yes".

Reviewing results discussed before, we note that (a) KPTV covers very nearly

KPTV



FIG. 16. This is an aerial view of the Portland area from a point about ten miles northeast of the business district. The location of the KPTV transmitter on a 1000-foot ridge on the other side of the city is indicated by the arrow. In the foreground of this picture is Rocky Butte, a sharp-sided hill some 300 feet high which causes the shadow "E" on the map of Fig. 11.

the whole Portland trading area, (b) there are some dead spots, but they are relatively unimportant. The Commission has one further requirement that is pertinent. This is that the station provide a signal level of 80 dbu (10 millivolts/meter) over the entire "principal city". Looking at Fig. 8 we see that KPTV provides this signal level out to about 13 miles, a distance which more than covers the whole of Portland.

Since the present operation meets the FCC's requirements, and gives very good service to nearly the whole area, we feel that the present power of 1 kw (16 kw ERP) is entirely sufficient as a starter.

Similarly, this power should be sufficient as a starter for nearly all other areas (all but the five or six largest) providing that a reasonably high antenna is provided.

Can the Results at Portland Be Used to Predict Coverage in Other Cities?

The answer is yes—but only if care is exercised to allow for differences in (a) antenna height, (b) flatness of terrain, (c) frequency, and (d) distribution of population.

We do not yet know enough about the effect of antenna height to be able to speak with certainty. However, we feel rather strongly that heights of 500 feet or more

above average terrain are essential. This is not because of propagation effects, per se, but rather because the greater the height the more homes which will have line-of-sight reception. In Portland you can go up on the roof of almost any house in the city (outside the shadowed areas) and see the antenna of KPTV. This would not be so if the antenna were only 200 or 300 feet high. In that case, the direct signal would have to come through trees and house tops to most receiving antennas.

Terrain is the predominating limitation on UHF coverage. At Portland we found good signals out to 30 miles in directions where the land was relatively flat. But in directions of rough terrain the signal was attenuated very rapidly. At 550 megacycles there is some "fill-in" behind hills. We found that for close-in hills the UHF shadows were about half the size of the light shadows. This means that if you have only an occasional hill to contend with the dead spots may not be serious. However, in very rough terrain the coverage will be limited to just a very little more than the area you can see from the transmitter.

Another question mark is frequency. KPTV operates on Channel 27, which is 548-554 megacycles. Here again our present information does not justify flat predictions as to the effect of frequency.

However, we do know that propagation is not as good at the higher frequencies, and that "fill-in" is less. It is likely, therefore, that results will not be as good at the higher frequencies.

Finally, and most important of all, is the question of the population distribution in the area to be covered. At Portland a very large part (practically all) of the population resided in favorable directions (that is, favorable as to terrain) from the transmitter. Thus good coverage of a very large percentage was a natural result. A less favorable distribution might greatly reduce the effectiveness of a UHF station.

All four of these factors must be considered in estimating how UHF will work in your area. If your antenna is as high as KPTV's, if your frequency is not too different, and if the terrain is as smooth (at least in the directions of large population), then you should get equally good results. If one or more of these conditions is not met, then some lesser degree of performance can be expected. How much less? We can't tell you right now. However, as more UHF stations come on the air we will try to bring you further reports. From these we hope to get more clues as to UHF performance under varying conditions, some of which certainly will be greatly different from those at Portland.

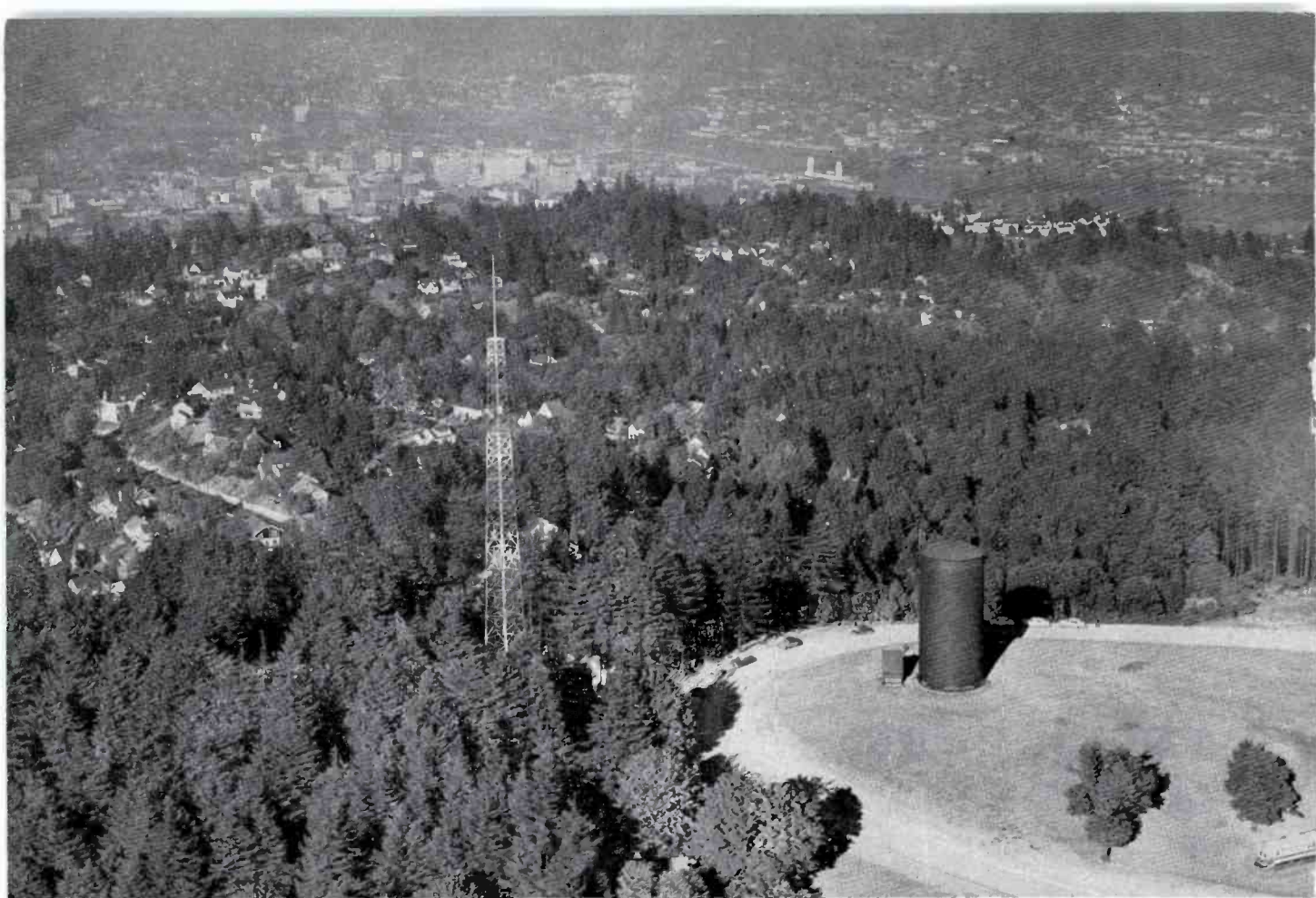

LOCATION of KPTV's transmitter plant is on Council Crest, a 1000-foot ridge which is about two miles east of the downtown district of Portland, visible in the top left of this picture. The site, which is a city-owned park, has long been a local landmark. Looking down not only on the city to the east, but also on the suburban residential area to the west, it is an ideal location providing line-of-sight transmission to most homes in the area.

KPTV - first commercial UHF station

BUILDING erected by Empire Coil to house the KPTV transmitter is shown below. Of brick and concrete construction it is 47 feet wide by 40 feet deep. Base of the tower, visible at the left of this picture, is about fifty feet from the building. Parabola on the roof is microwave link from downtown telephone office.

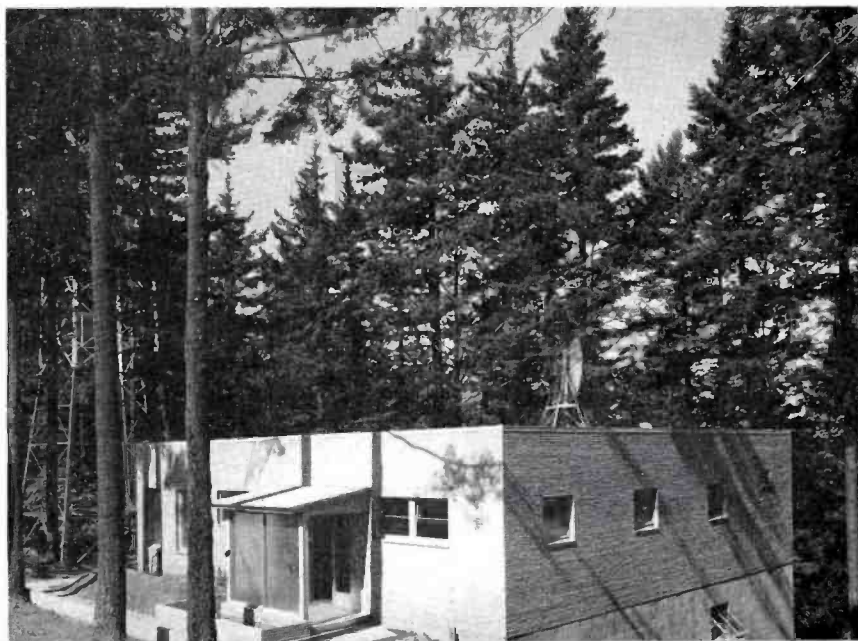

KPTV, Portland's first TV station—and the world's first commercial UHF television station—is owned and operated by the Empire Coil Company. Assigned to Channel 27 (548-554 mc) it is presently operating with an effective radiated power of 16 kilowatts.

When KPTV was granted a construction permit on July 7th, no one had any idea that the station would be on the air before the last of the year. But Herbert Mayer, Empire's energetic young president, was in a hurry. Finding that no transmitters would be coming from the factory before November, he decided that he wanted the RCA TTU-1A Transmitter which was in use at Bridgeport. There were others who wanted this famous transmitter. But



TRANSMITTER ROOM. shown above, houses RCA TTU-1A Transmitter (right center) and control racks (far right). This room was purposely made large enough to allow for addition of 10-kw amplifier at a later date. At the present time, the station film equipment (far left, above) and film and network control equipment (combined with transmitter desk) are also located in this room. With an enclosed announce booth (not shown) this provides for complete operation from this point until KPTV's studios are completed.

Herb Mayer won the nod by persuading RCA that it would be doing a public service in sending this first UHF transmitter to Portland, then the largest unserved television market in the country.

Dismantling of the transmitter at Bridgeport began on August 23. The disassembled equipment was loaded on a truck and driven across country to the new transmitter site in Portland. Meantime, Herb Mayer had sent his top assistant, Dick Freeman, Vice President of Empire Coil, to Portland to get things going. Dick arranged with the city for use of the site, ordered the necessary facilities and got the building under way.

By the time the transmitter arrived the roof was on the building and the equipment could be moved in. By September 15 the transmitter was ready for power tests. On September 18 authority to test was received and the first pattern went on the air. On September 20 regular programming was begun, and KPTV became a reality.

Despite the rapidity with which it was erected KPTV's transmitter plant is excellently arranged and the equipment installation is letter-perfect. The location, building and equipment are pictured and

described in the illustrations and captions on this and the following pages. When KPTV's downtown studio is finished late this year, the station's facilities will compare with the finest in the nation.

Overall engineering planning of the KPTV installation, including site selection and general supervision of the project, was

done by Adler Communications Laboratories, of New Rochelle, N. Y., engineers of record. Installation of overall technical facilities was supervised by Tom Friedman, Chief Engineer of WXEL (Empire Coil's Cleveland station) and Russell Olsen, who has been appointed Chief Engineer of KPTV. The RCA Service Company supervised installation of the RCA equipment.

SUPERVISORS of KPTV's technical operations, shown below in front of the RCA TTU-1A Transmitter, are Chief Engineer Russell K. Olsen, formerly Assistant Chief at WEWS, and Transmitter Engineer William McAllister, formerly NBC engineer at KC2XAK, Bridgeport.

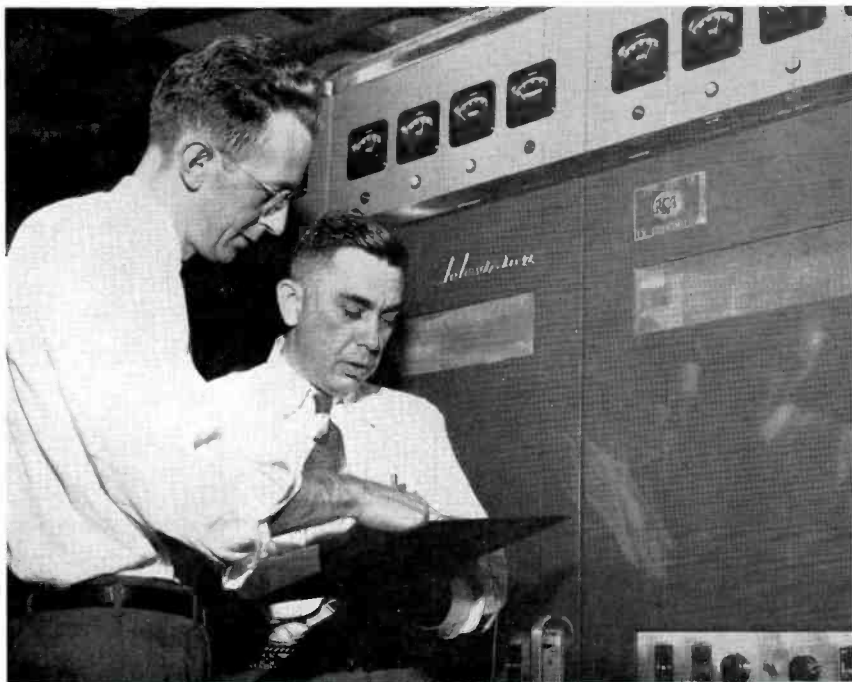

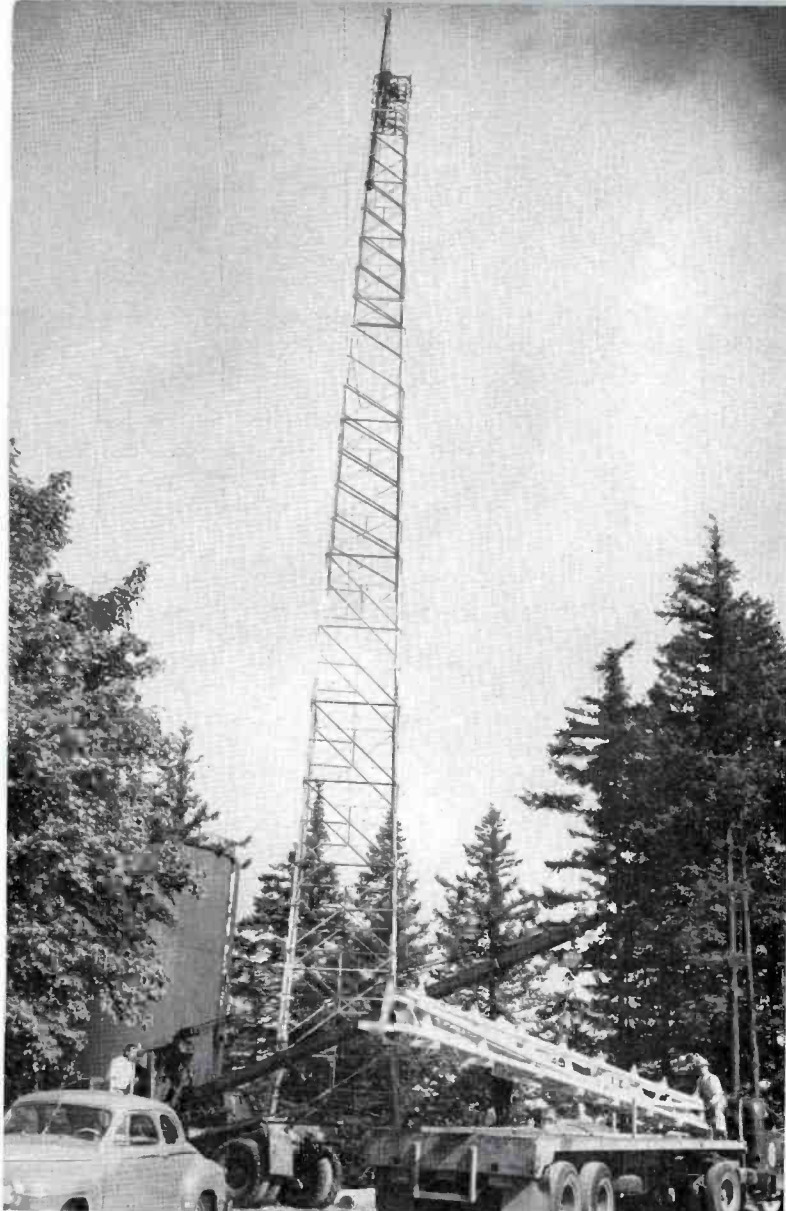

FIG. 1. Unloading the RCA TFU-21B Antenna at KPTV. Because it has no protruding elements the RCA UHF Pylon is easily crated and shipped as a complete unit.

FIG. 2 (below). Every RCA UHF Pylon is completely checked out and its vertical pattern measured before it is shipped from Camden.

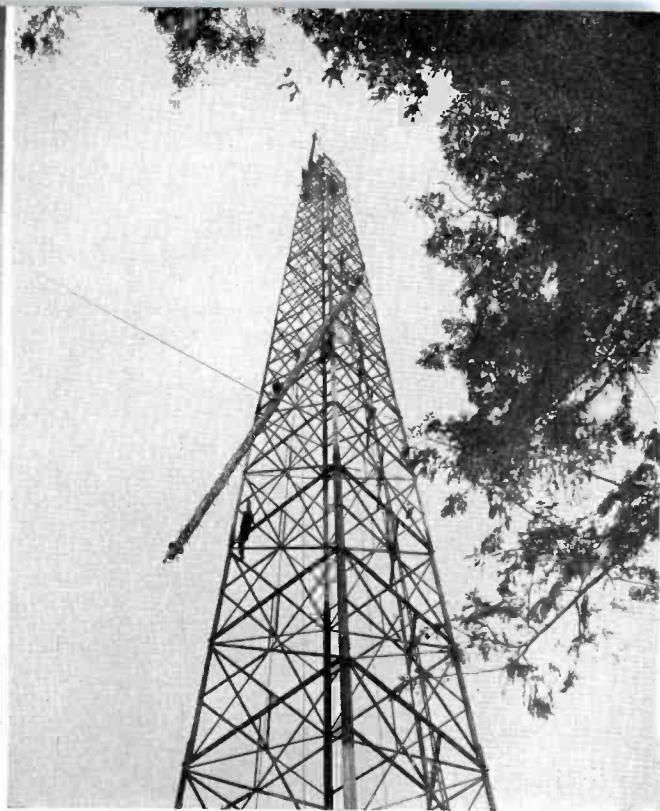
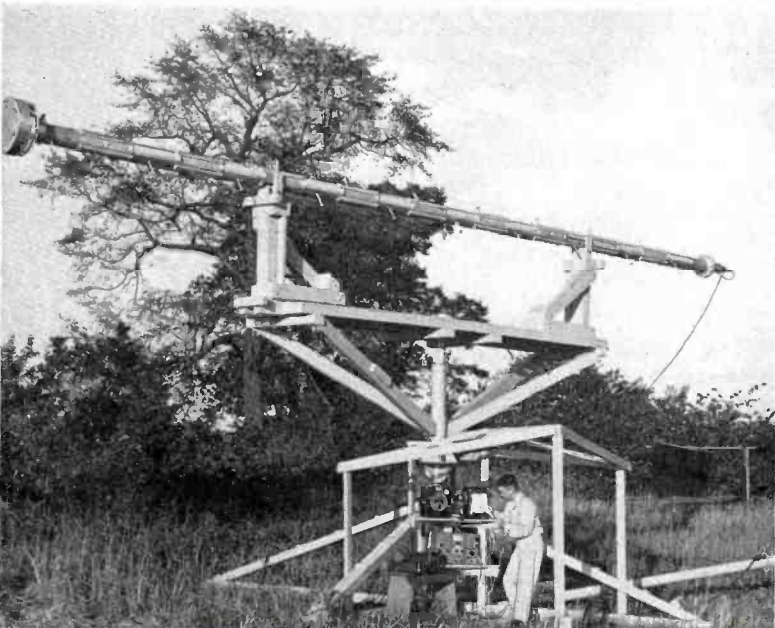

FIG. 3. Raising the RCA Pylon at KPTV. A single strong unit, this antenna is easily lifted into place without unusual precautions to prevent damage to protruding elements.

KPTV'S

Although most of the equipment for KPTV was obtained from Bridgeport it was not possible to use the KC2XAK antenna because of the difference in operating frequency. It was necessary, therefore, to obtain an all-new antenna in record time.

Fortunately, RCA had UHF transmitting antennas in production. Special expediting was employed to rush one of these through final assembly. Because of the importance of the project complete pattern tests were made at an accelerated pace. The antenna was then shipped (completely assembled) in a special express car. Because of the relative simplicity of this type of antenna—and the fact that there are no protruding elements to be attached at the location—it is very simple to erect. At Portland it was erected on the tower and tested *the same day it arrived*.

The KPTV antenna, an RCA Type TFU-21B, is 10¾ inches in diameter and 41½ feet long. It is made of ½ inch thick cold-rolled steel tubing with radiating slots cut in at proper points to provide a uniform circular pattern. Power is fed to the radiating slots by a single line feed system which runs up the inside of the tube. This simple

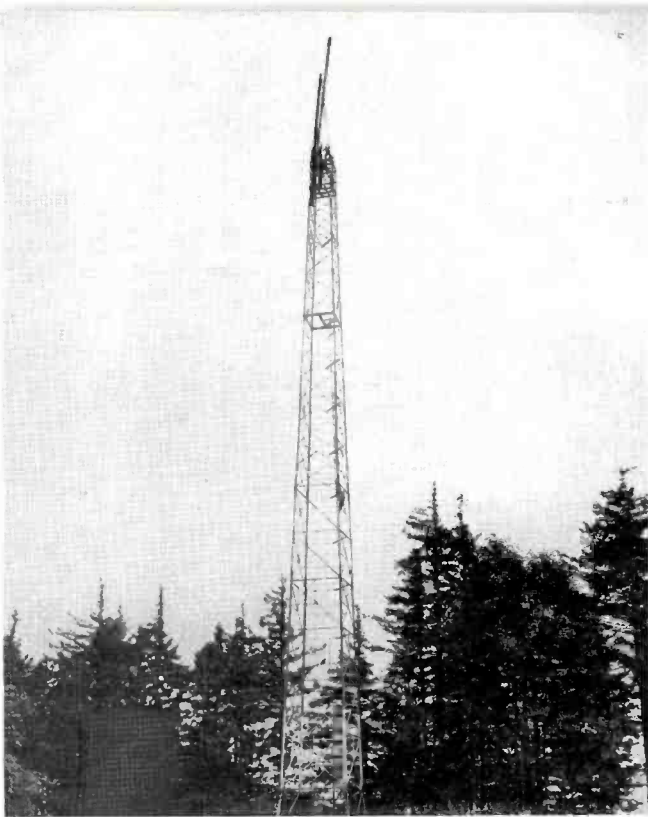

FIG. 4. At the top of the tower a gin pole of reasonable dimensions is used to set the antenna in place. There is nothing to be mounted on the antenna after it is put in place.

Antenna

feed system, well-protected from the weather, provides a high degree of reliability.

The TFU-21B when adjusted for maximum horizontal radiation has a gain of approximately 21. However, at KPTV in order to improve signal strength near the transmitter, the antenna was adjusted for 1 degree electrical deflection. This eliminates the "first null" and increases the amount of signal in the "second null" of the vertical pattern. With this adjustment the gain in the horizontal direction is 16.

In addition the antenna was mechanically tilted about 1 degree toward the city at the time it was erected. This tends to further increase the signal in the city proper.

The antenna proper is mounted on the top of a 200-foot tower which is located about 50 feet from the transmitter building. A filterplexer, mounted just behind the transmitter, combines the aural and visual signals so that they may be fed to the antenna by a single line. Power is fed from the filterplexer to the antenna by a 3 1/8-inch coaxial line especially designed for UHF service.

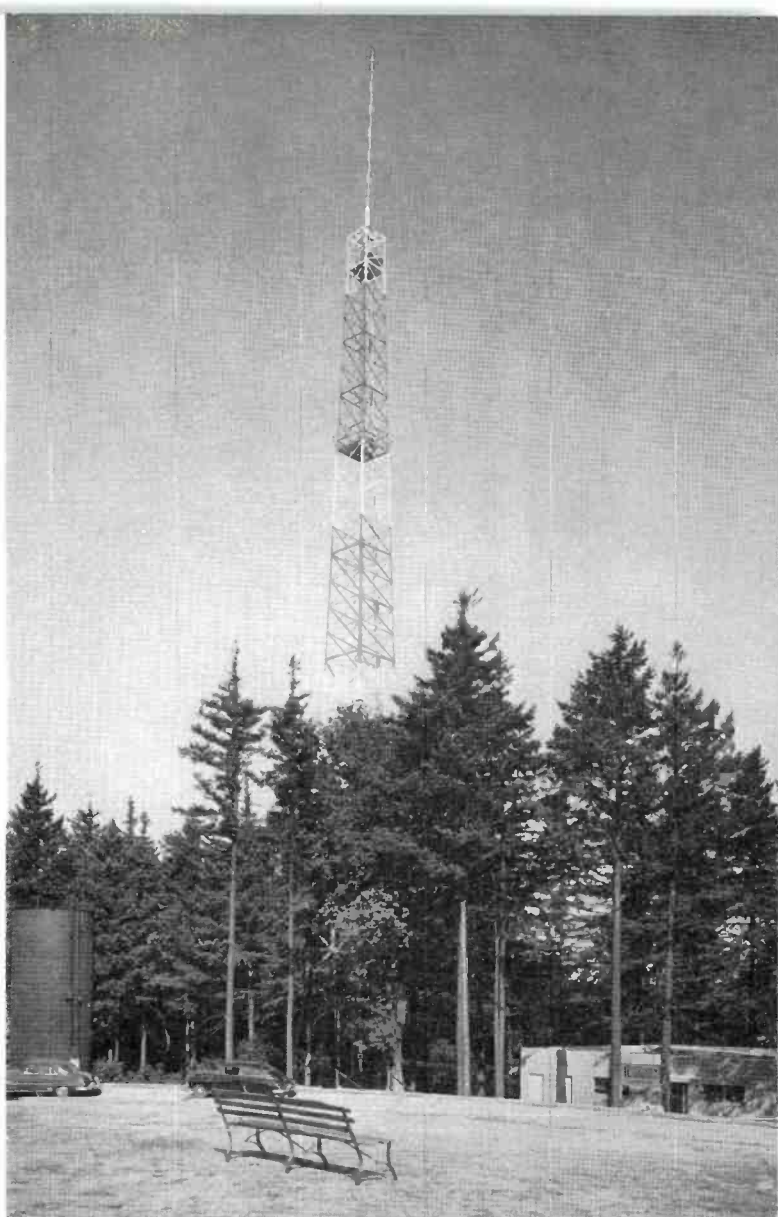
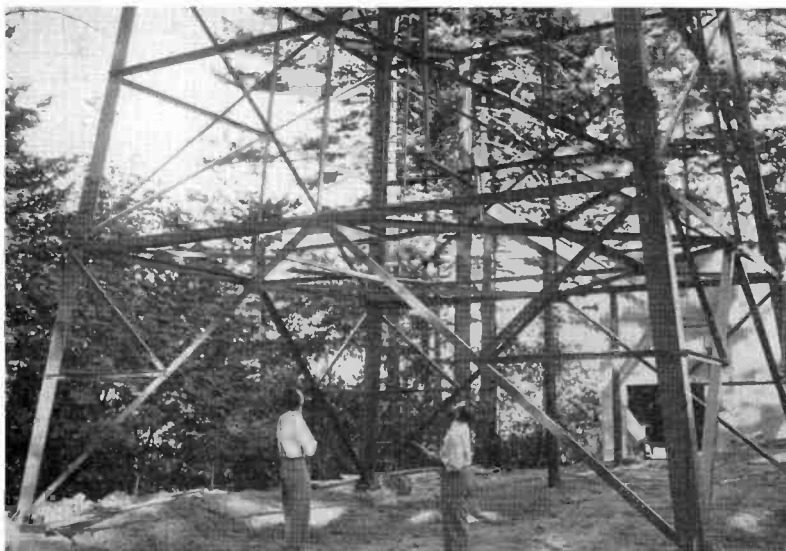

FIG. 5. The KPTV antenna on its 200-foot tower presents an impressive, and even beautiful sight. There are no exterior elements for ice to form on. Nothing to be cleaned, little or no servicing.

FIG. 6 (below). View of the base of the tower showing the single 3 1/8-inch coaxial line which feeds power from the transmitter to the antenna.



FEED SYSTEMS FOR THE NEW 12-SECTION SUPERTURNSTILE ANTENNA

By **L. J. WOLF**

Broadcast Engineering Section
Engineering Products Department

Concurrent with FCC's authorization of higher values of Effective Radiated Power for VHF Television, the need for a suitable high-gain, heavy-duty VHF Antenna became apparent. And now, the popular family of Superturnstiles can point to such an antenna in its newest member, the RCA 12-Section Superturnstile. Shown in the dramatic closeup of Fig. 1 and overall view of Fig. 2. The new antenna design includes three models—TF-12AL, TF-12AM and TF-12AH to cover the entire VHF band from channel 2 to 13. They are capable of high gain and correspondingly higher power handling (all are rated for 50-KW input). The high-gain antenna when used in combination with RCA VHF Transmitters can provide effective radiated power up to 600 KW, more than adequate to meet FCC maximum limits.

The new 12-Section Superturnstile Antennas provide for operation on any VHF channel from 2 to 13. Its design includes many distinct features which will be described in detail in future issues of BROADCAST NEWS. It is the purpose of this article to point out several "bonus" features or "by-products" resulting from the overall design of the 12-Section Antenna such as: versatile feed systems, power switching, beam tilting and vertical pattern shaping by power division. Each of these considerations is described in the paragraphs to follow.

FIG. 1. B. T. Bailey of RCA's Engineering Products Department, shown adjusting a batwing element on RCA's new 12-Section Superturnstile Antenna.



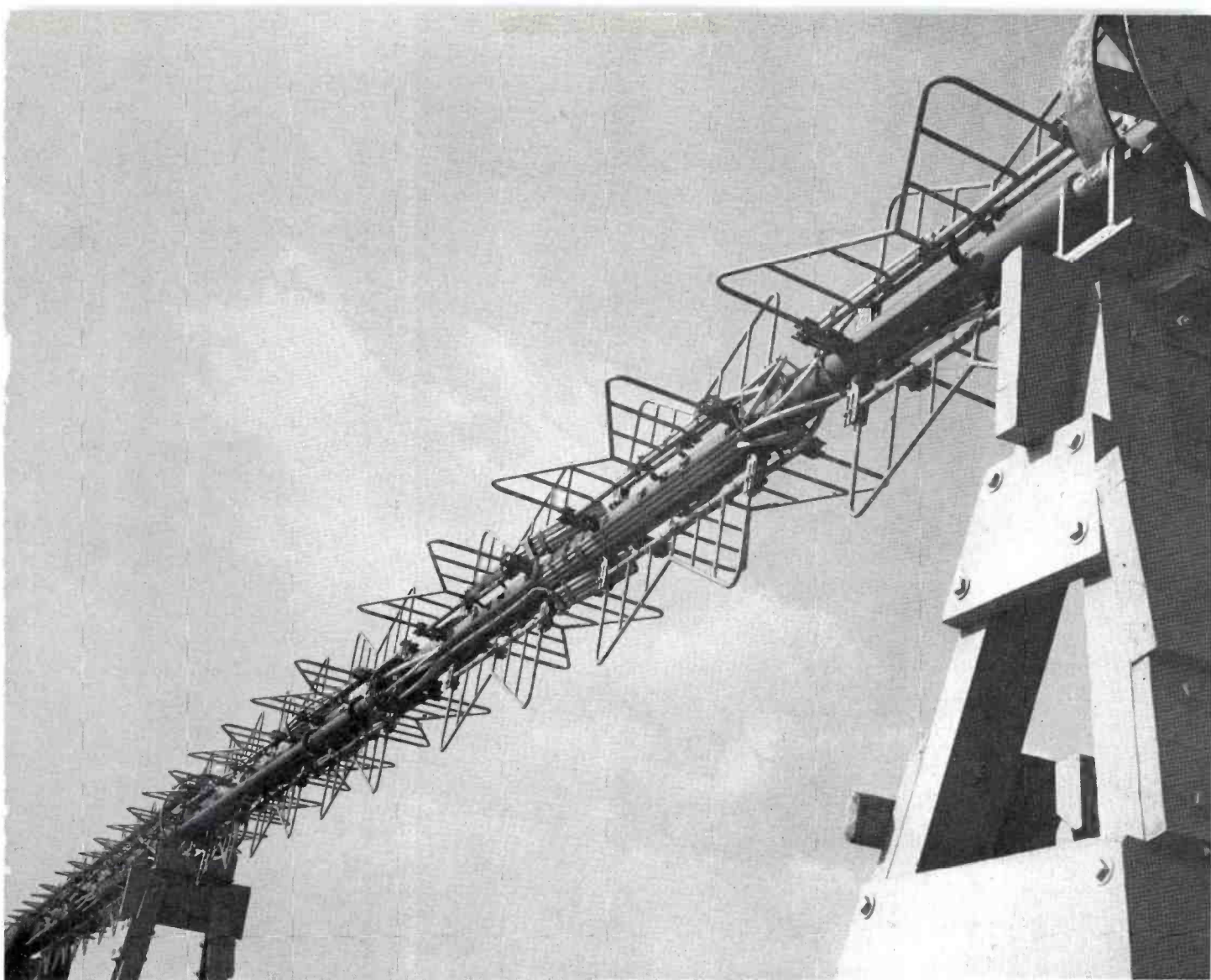

FIG. 2. View of the new 12-Section VHF Antenna. Type TF-12AH for high-band operation. This setup permits field measurements of both power gain and coverage patterns.

The Feed System of the 12-Section Antenna

All of the 12-Section Antennas have four transmission lines brought down through the tower top. One pair of these transmission lines is for the north-south and the east-west radiators of the upper half; the other pair feeds the radiators of the lower half in the same way. The combining tees are shown with the notation "C" in Fig. 3.

The feature of these antennas which permits sectionalized connections is the separately fed upper and lower layers, as well as the previously used arrangement wherein the north-south and east-west radiators are also separately fed.

Versatility has been provided in the newly designed 12-Section Antennas through the arrangement of sectionalized connections

and an advanced design of the junction boxes, feedlines and other components (see Figs. 4 and 6). This permits the switching of transmitter power to another part of the antenna for lower power operation should the occasion arise. In this way, service can continue until complete operation can be restored.

Vertical Pattern Shaping by Power Division

Effective close-in coverage and the shaping of the vertical field pattern to obtain a substantially constant field throughout the service area are accomplished by use of optimum power ratios between the upper and lower halves of the antenna.

Combining tees are used to divide the power from the transmitter in any desired

ratio between two sections of the antenna. Ordinarily, the upper and lower sections are fed by equal feedline lengths in the same phase and with a 70:30 power distribution. However, it is easily possible to adjust the ratio of power division between the upper and lower parts of the antenna to achieve the vertical pattern and uniform field mentioned above. For instance, if the power is split in the ratio of 70%-30% between the upper and lower sections of the antenna respectively, the first null is almost completely eliminated with practically no sacrifice in gain.

Beam Tilting for Special Conditions

Beam tilting is a feature, easily obtained with RCA 12-Section Superturbo Antennas, which provides greater field

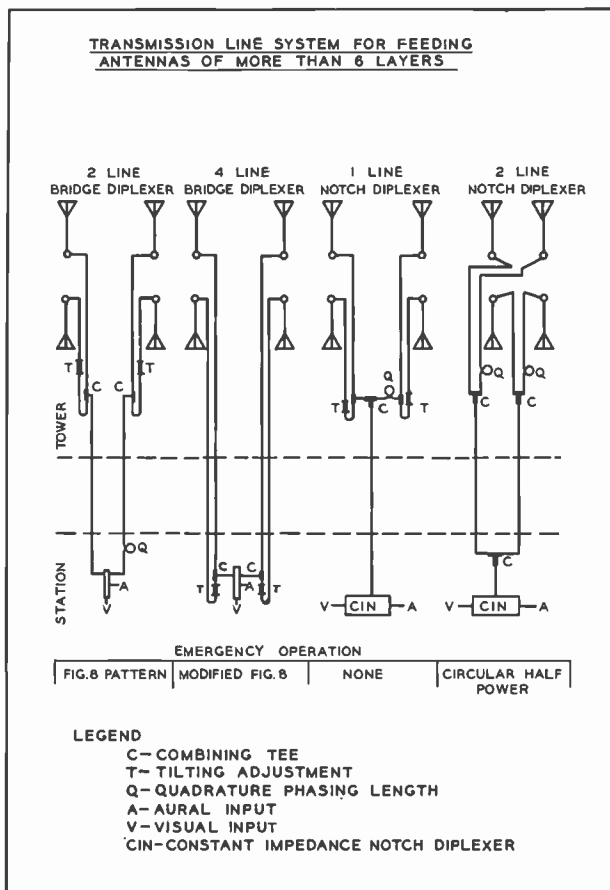

FIG. 3. Chart showing versatility of transmission line systems available with 12-Section Antennas.

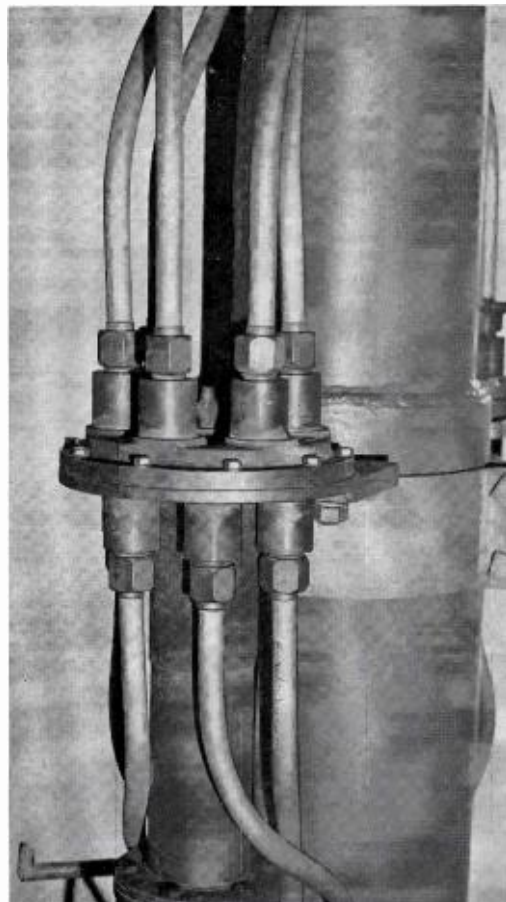

FIG. 4. Power enters above the junction box through 3/8-inch transmission line and connects through smaller feedlines to individual radiators.

strength for selected portions of the primary service area. This is obtained by changing the phasing between the upper and lower halves of the antenna with the standard feed system (see tilting adjustment in "antenna feeding" chart—Fig. 3). A change in the tilt angle is made by exchanging the sections of line labeled "T" for other sections to give the desired tilt.

Feed System and Diplexing Considerations

In this article, the four different methods of feeding the power to the 12-Section Antenna are described. Each system is illustrated by diagrams showing the connections made to the antenna.

The proper choice of feed system to employ will depend upon the individual station requirement and should be made after a careful study of the merits of each system.

One of the most important factors to consider before selecting a feed system is the choice of the type of diplexer to be used. Therefore, it is perhaps appropriate, at this point, to review the function of the diplexer as applied to the overall TV antenna system and define the term "diplexer".

The television antenna system consists of a coordinated chain of components which receive the aural and visual r-f power from the television transmitter and includes a vestigial sideband filter to remove the unwanted visual sidebands. The signal then passes through a diplexer to combine the visual and aural energy, and then carries the combined power through the coaxial transmission line to the antenna to be radiated.

A diplexer can be defined as a network arranged so that both transmitters can

couple into a single antenna without interaction between them. The diplexer must

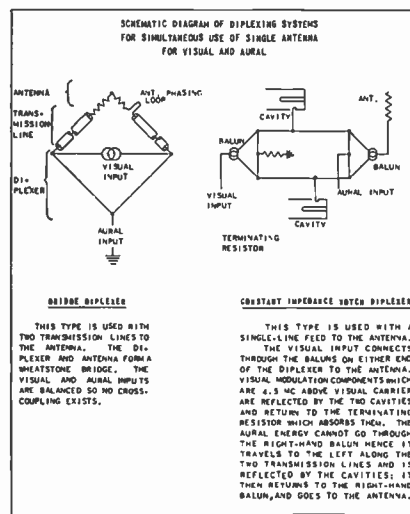

FIG. 5. Either of two types of diplexers can be used with RCA antennas.

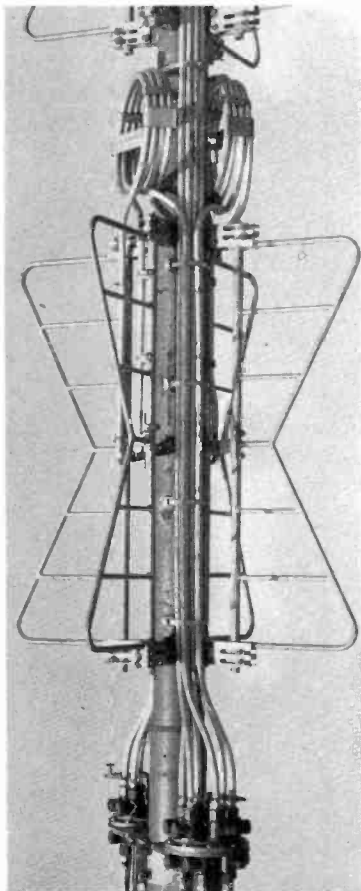

FIG. 6.

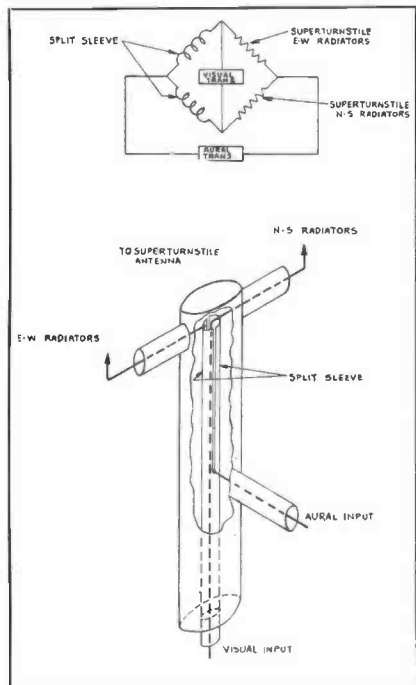

FIG. 7. Bridge diplexer—used in most installations.

do this intercoupling and, at the same time, maintain a constant impedance load on the two transmitters. Diplexers are of two general types; the bridge type, which is generally used and requires at least two coaxial transmission lines to the antenna; and the constant impedance notch type, which requires only a single line to the antenna. See Fig. 5.

Bridge diplexing, as illustrated in Fig. 7, is a popular system since it provides a simple way of utilizing the same antenna for both visual and aural. The Constant Impedance Notch Diplexer and the recently announced Filterplexer (a combina-

tion vestigial sideband filter and constant impedance notch diplexer) are other diplexing methods employed. Each has its merits and the various factors of performance cost, and transmission lines involved are discussed below.

A. Standard—Bridge Diplexer

This is shown under (A) in Fig. 3 and is the system usually used since it requires only two transmission lines and uses the inexpensive bridge diplexer. The combining tees which improve pattern circularity are shown in Fig. 3 between the four transmission lines in the antenna and the two lines that run from the tower top to the station.

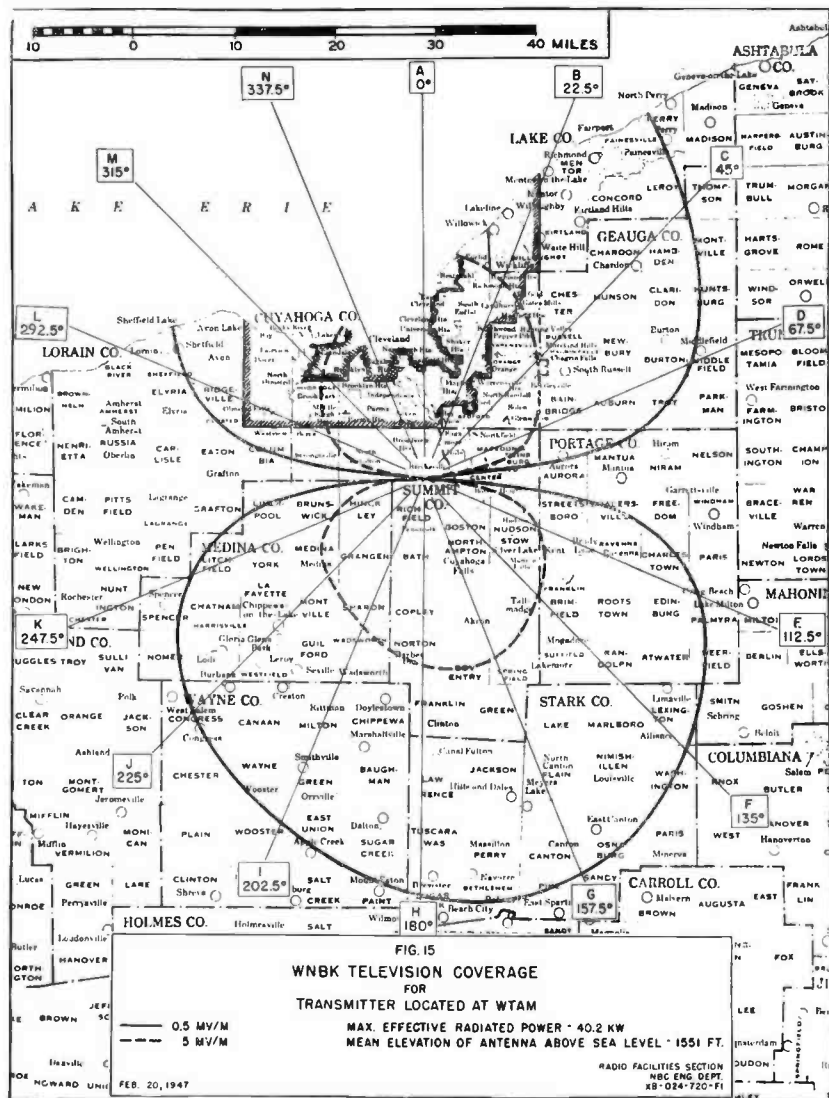

FIG. 8. Grade A and Grade B coverage patterns under figure-8 pattern emergency connection.

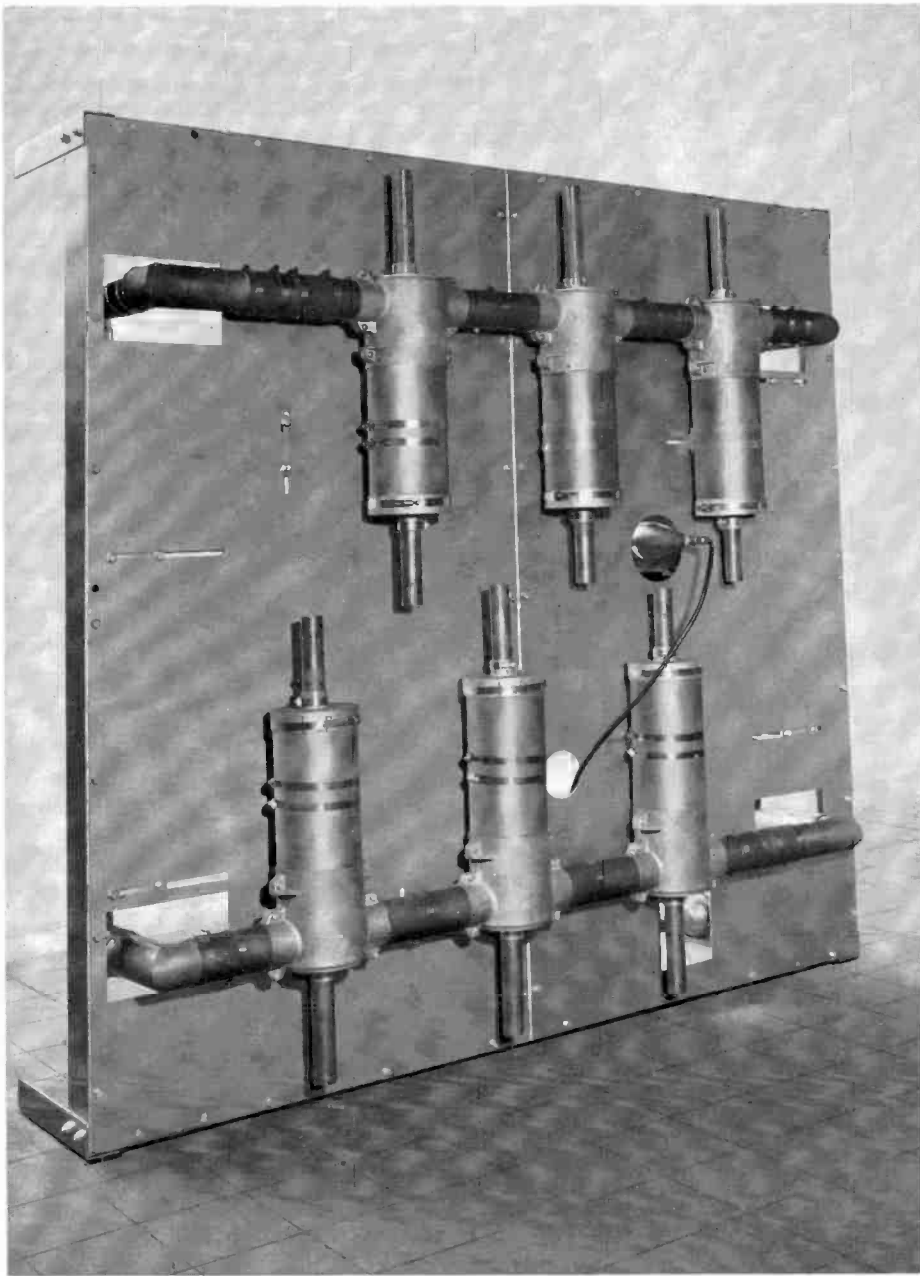

FIG. 9. The Filterplexer can mount either from the overhead or against the wall.

With this arrangement, emergency service giving a figure-8 coverage pattern can be obtained by disconnecting the defective transmission line at the diplexer in the station and substituting the r-f Load and Wattmeter enables the diplexer operation to be normal. Fig. 8 shows a typical coverage pattern for this figure-8 condition. Notice that the two nulls in the horizontal

pattern are rather sharp, so that only a small portion of the coverage is lost. If the other half of the antenna were defective, the nulls would, of course, be changed by 90 degrees. Through suitable choice of antenna orientation, it is possible to provide for the least objectionable loss of coverage in case it is necessary to go to either of the two figure-8 conditions.

B. Four-Line Feed—Bridge Diplexer

As shown in Fig. 3, this system uses four transmission lines from antenna to station. It is particularly applicable to mountain-top or tall building installations where the length of transmission line is comparatively short. This system has a minimum of equipment in the tower top, since both the tilt adjustment and the combining tees are located in the transmitter room.

Emergency service is easily obtained by disconnecting the defective line and substituting the r-f Load and Wattmeter. Only one-fourth of the power is thus lost. The normal coverage pattern will be unaffected in two directions; in the other two directions, it will be reduced only slightly since the field strength is decreased about 30%.

C. Single-Line Feed—CIN Diplexer¹ or Filterplexer

This is illustrated in Fig. 3. The single transmission line is particularly applicable to installations which have a long run between antenna and transmitter, such as an antenna on a very high tower for instance, and which has other provisions for emergency service. The use of a single line results in less wind-loading on the tower and in a smaller cost for the line. With this system, three combining tees are used, as shown in the figure. If a filterplexer,* as shown in the photo of Fig. 9 and the schematic of Fig. 10 is used, the station equipment cost is not much more than for a bridge diplexed system.

As mentioned above, this system does not provide for emergency low-power service in any way; hence, it is necessary to have a separate antenna and transmission line if emergency service facilities are required.

D. Two-Line Feed—CIN Diplexer or Filterplexer

As shown in Fig. 3, this system utilizes two transmission lines, connected respectively to the upper and lower sections of the antenna. This permits emergency service which retains the circular coverage pattern when only one section of the antenna is used. Three combining tees are used, one of which is in the station.

For emergency operation in case of failure of one of the transmission lines, the transmitter output is connected to the other good transmission line. The coverage pat-

* Combination Vestigial Sideband Filter and Constant-Impedance Notch Diplexer.

¹ I. E. Goldstein and H. E. King, "Constant-Impedance Notch Diplexers", BROADCAST NEWS, September-October, 1952.

tern will thus remain circular. If the corresponding section of the antenna is rated for full transmitter output, then the field strength will be 70% when full transmitter power is being used, but with half of the antenna gain.

The foregoing descriptions have depicted in detail the four connection systems for diplexing visual and aural into the 12-Section Antennas. The following table summarizes this information:

6-Section Antennas

The foregoing description has referred only to antennas such as the 12-Section Superturnstiles which are fed with four lines down to the tower top. The 6-Section Antennas have two lines only: with these two feed methods being possible. These, correspond to the A. (Standard, 2-Line, Bridge) and the C. (Single-Line, CIN or Filterplexer) systems. With these 6-Section Antennas, it is not essential to make beam tilting or power division changes. See Fig. 11.

	A Standard Bridge	B 4-Line Bridge	C 1-Line CIN	D 2-Line CIN
Number of Transmission Lines Required	2	4	1	2
Emergency Usage	Figure 8 pattern	Figure 8 with nulls partially filled in	None	Circular pattern half gain
Diplexer	Bridge	Bridge	CIN or Filterplexer	CIN or Filterplexer
Best Usage	For most stations	For maximum flexibility	Long transmission line cases where emergency use not required	Where good emergency facility is required

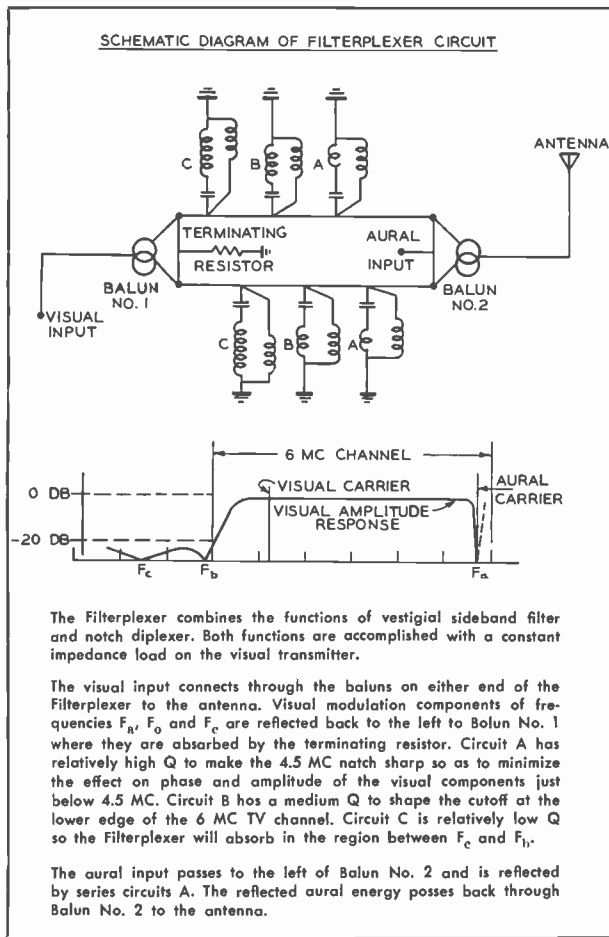

FIG. 10. The frequency response and impedance characteristic of the Filterplexer result in the excellent performance of this unit.

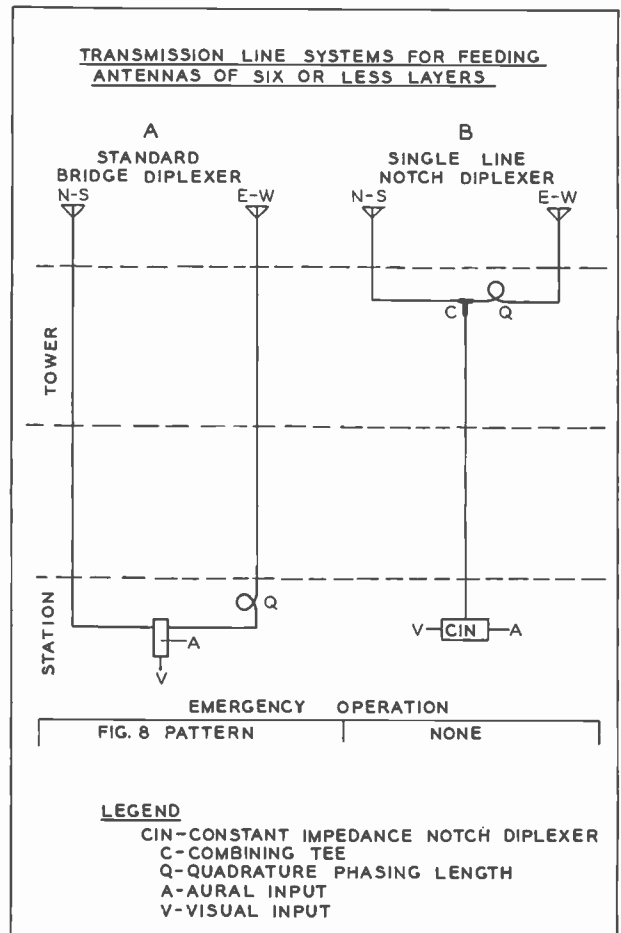

FIG. 11. Transmission line systems chart showing two transmission line arrangements available for 6-Layer Antennas.

"CLOSE-IN" COVERAGE WITH HIGH-GAIN, VHF ANTENNAS

By

IRL NEWTON

Product Administration Section
Broadcast Antenna Equipment

In achieving the higher values of Effective Radiated Power permitted by new FCC rules, Television Stations will require (a) the use of more powerful transmitters, (b) the use of antennas with higher gain, or (c) a combination of "a" and "b" above. For nearly every assignment except temporary, interim, or emergency—the Effective Radiated Power will exceed the actual radiated power. This increase will be achieved by concentrating the energy rad-

iated from the antenna in vertical-plane directions which are effective in delivering a signal to the receivers in the service area.

Gain Considerations

The use of 316 kilowatts into a unity-gain antenna for VHF channels 7 to 13 would be extremely impractical and uneconomical in comparison with a twenty-five or fifty kilowatt transmitter and an antenna gain sufficient to obtain the same

ERP and same distant coverage. In addition, the radiation of this high power at angles considerably below the horizon would result in excessive signal and "blanketing" problems within approximately two miles of the antenna. On the other hand, excessive antenna gain or concentration of the radiated energy in the horizontal plane, though permitting exceptional economy in the initial transmitter installation and operating cost, would result in an inadequate

FIG. 1. (316 KW. ERP.) Coverage obtained with 12-Section High Gain Antenna at 1000 ft. height, 0° beam tilt and 50/50 power split.

FIG. 2. (316 KW. ERP.) Coverage obtained with 12-Section High Gain Antenna at 1000 ft. height, 0° beam tilt and 70/30 power split.

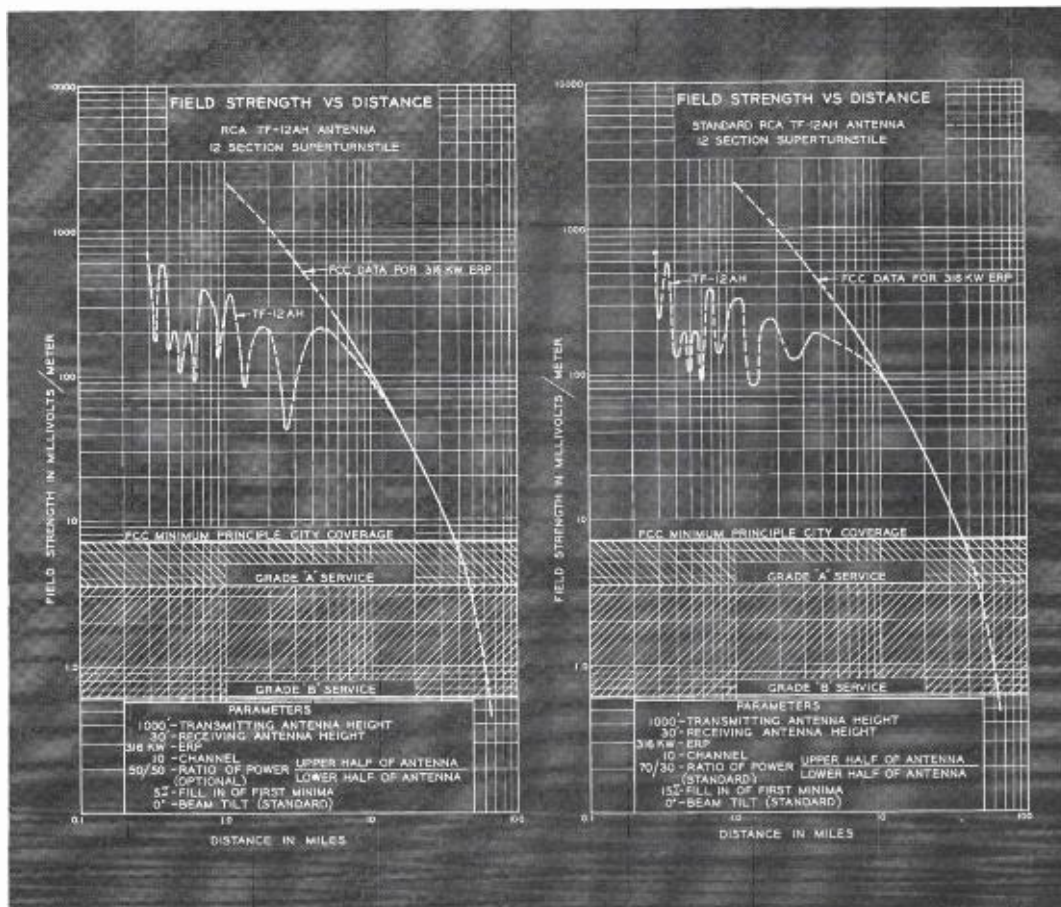

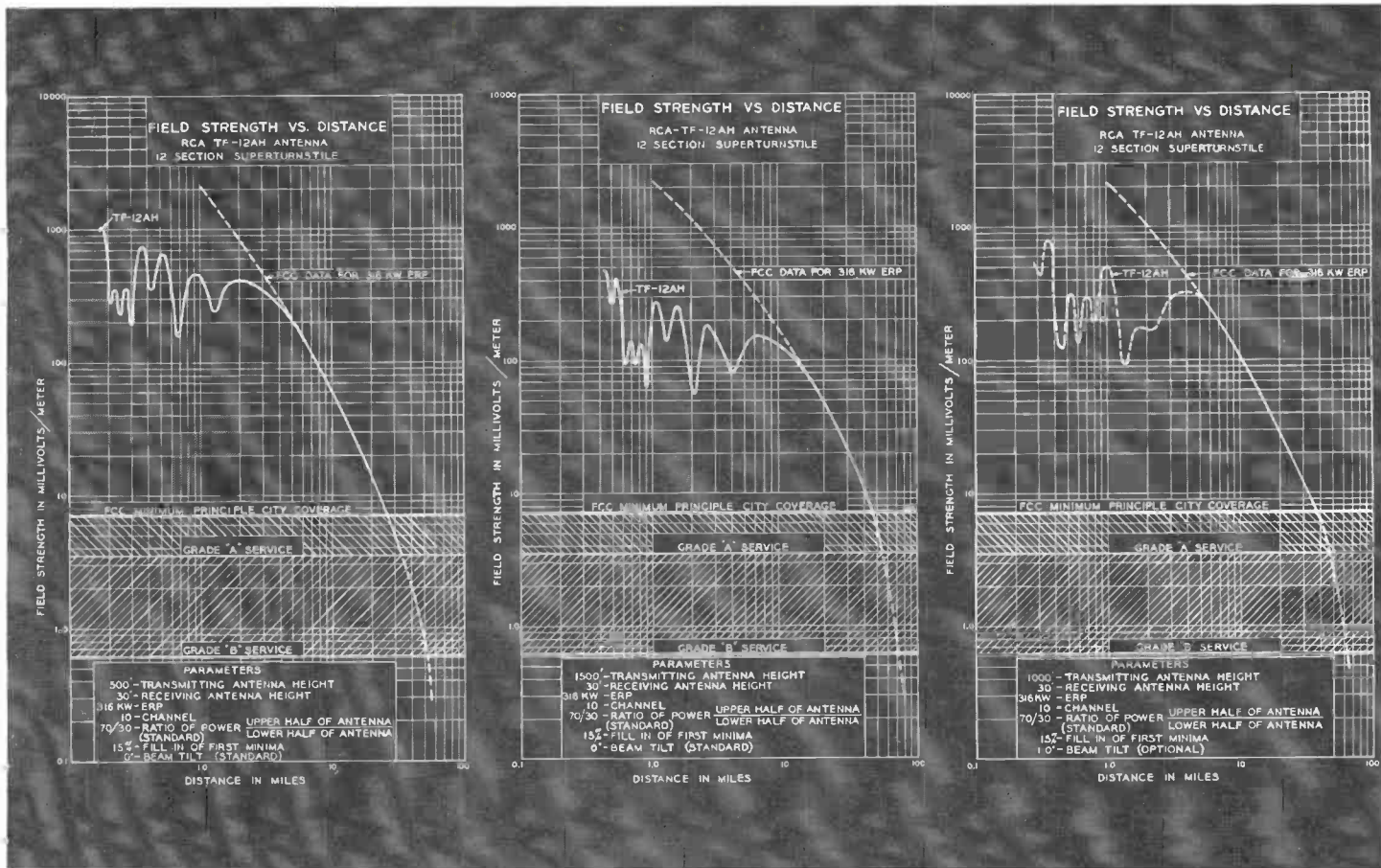

FIG. 3. (316 KW, ERP.) Coverage obtained with 12-Section High Gain Antenna at 500 ft. height, 0° beam tilt and 70/30 power split.

FIG. 4. (316 KW, ERP.) Coverage obtained with 12-Section High Gain Antenna at 1500 ft. height, 0° beam tilt and 70/30 power split.

FIG. 5. (316 KW, ERP.) Coverage obtained with 12-Section Antenna at 1000 ft. height, 1° beam tilt and 70/30 power split.

signal in the first few miles from the antenna.

Normally, there are very few, if any, receivers within a radius equal to the tower height. Yet that extremely small area represents an arc of 45° to 90° of depression angle of the vertical pattern. This arc plus the symmetrical elevation angles accounts for one-half of the power radiated from a unity gain or dipole antenna. Elimination of power within this circle about the base of the tower would reduce the transmitter power by one-half for an equivalent service area. Similarly, the power requirement is cut 75% by antenna gain to eliminate radiation below a depression angle of 22.5° representing a radius of only 2.4 times the tower height. In practical installations it is not desirable to totally eliminate any area under the tower—particularly in the case of very tall towers in a populated district. However, these ex-

amples serve to illustrate the tremendous value of antenna gain and "Effective Radiated Power" as compared to Transmitter Power.

If a given value of ERP will deliver an adequately strong signal at a distance of 10 miles, less than 1% of the power is required to deliver the same value of signal at a distance of one mile—a depression angle of 5.4° for an antenna height of 500 feet. Thus it is readily apparent that in practical antennas virtually all of the power can be concentrated in a narrow beam without degradation of the close-in service.

The "Ideal" Antenna

The "ideal" antenna vertical pattern will vary with the range of possible antenna heights and will deliver a constant high-level signal out to the point where normal

dispersion and attenuation predominate. This design would be unique for each installation and would be based upon an analysis of terrain to determine the radiation required at each depression angle to produce the required signal strength at the pertinent distance. In addition there would be no wasted power in radiation above the angle of the horizon. Such installations require extensive engineering development and (although providing excellent results), may not fall within the economic limits of most budgets.

The objective of present day antenna design is the production of a standardized antenna with a gain and vertical pattern which is optimum for the widest possible range of conditions and a degree of flexibility which permits optimizing performance for the individual installation. Such an antenna is now available in the RCA 12-section antennas. The versatility of

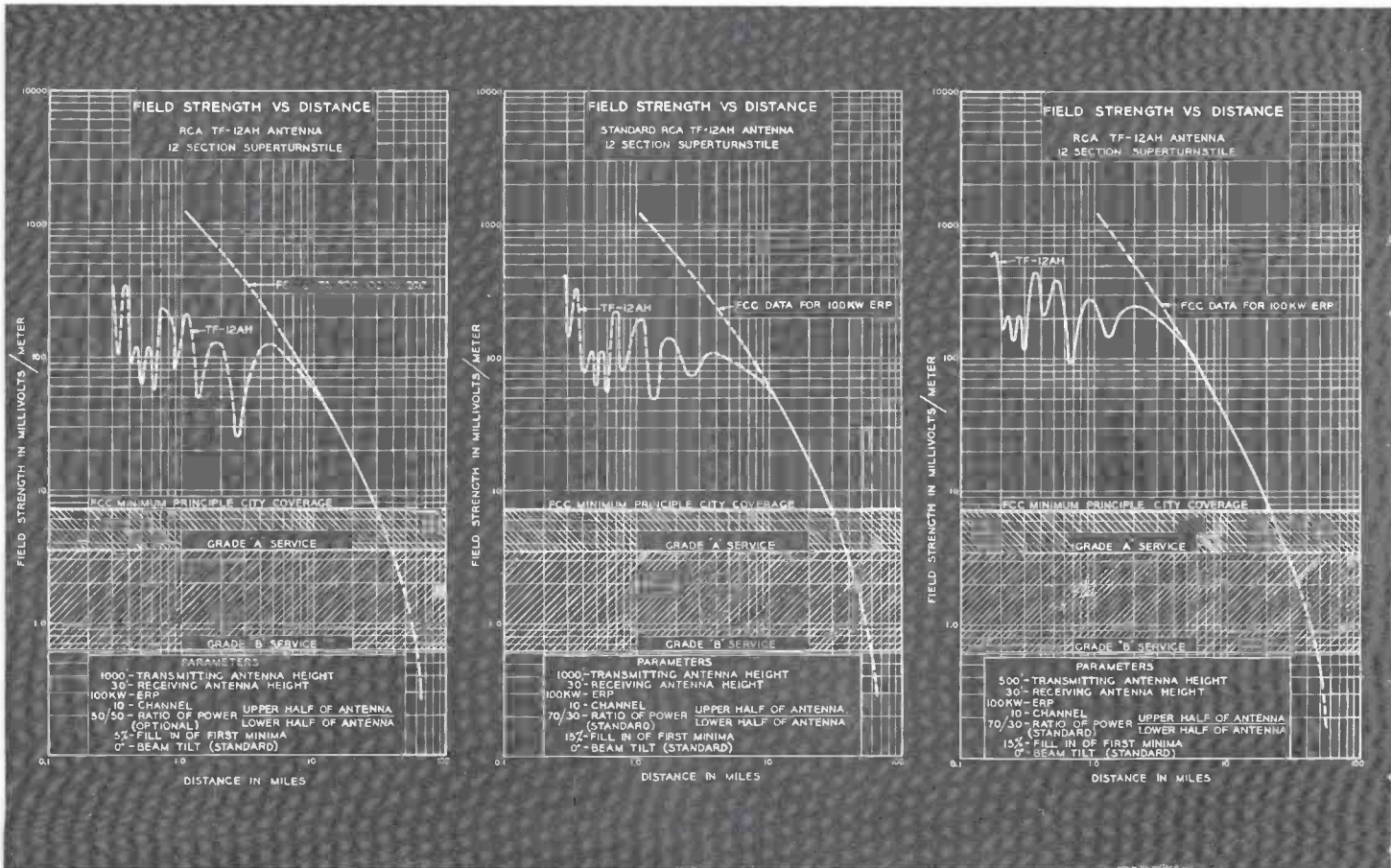

FIG. 6. (100 KW, ERP.) Coverage obtained with 12-Section High Gain Antenna at 1000 ft. height, 0° beam tilt and 50/50 power split.

FIG. 7. (100 KW, ERP.) Coverage obtained with 12-Section High Gain Antenna at 1000 ft. height, 0° beam tilt and 70/30 power split.

FIG. 8. (100 KW, ERP.) Coverage obtained with 12-Section High Gain Antenna at 500 ft. height, 0° beam tilt and 70/30 power split.

these antennas obtained through flexibility of the feed system is described in a separate article in this issue of BROADCAST NEWS.

Theoretical Coverage Curves

Following are a number of computed "Field Strength versus Distance" Radial graphs illustrating typical theoretical performance under a variety of conditions for the VHF high band. The charts were computed using the FCC curves as contained in the April 14, 1952, "Sixth Report," and the ERP at the various pertinent vertical angles of the 12-section antenna pattern. The fill-in of theoretically zero nulls is based upon typical superturnstile turntable measurements. Fig. 1 illustrates the calculated performance with uniform power distribution in the antenna for channel 10 and a transmitting antenna height of 1,000 feet.

Why the 70-30 Power Split?

As illustrated by Fig. 2, a substantial improvement for the same channel and antenna height is obtained at a very small sacrifice of gain by changing the power distribution to a 70-30 split between the upper and lower six sections of the antenna. The standard antenna will be shipped with the 70-30 split although a 50-50 or 60-40 split is optional. Figs. 3 and 4 illustrate the calculated performance with the standard 70-30 split for antenna heights of 500 feet and 1,500 feet respectively.

Beam Tilt

For high-antenna locations additional improvement without loss of signal at the horizon may be obtained by tilting the angle of the main beam below the horizontal plane. It will be noted from the accompanying Table I that the horizon is depressed below the horizontal plane for

H	D	A°
200	20.0	.216
300	24.5	.268
400	28.3	.304
500	31.6	.343
600	34.6	.375
700	37.4	.405
800	40.0	.435
900	42.4	.452
1000	45.0	.487
1200	49.0	.530
1400	53.0	.577
1600	56.6	.620
1800	60.0	.650
2000	63.2	.683
5000	100.0	1.080

H—Height in Feet to Electrical Center of Antenna
D—Distance to Horizon (4/3 Earth Radius)
A—Depression Angle to Horizon

FIG. 9. Table of distance and depression angle to horizon. This illustrates optimum beam tilt angle for maximum coverage.

high antenna installations. Tilting the main beam will result in substantial signal increases in some sectors as illustrated in Fig. 5 for a tilt angle of one degree with an antenna height of 1,000 feet.

The FCC rules limit the maximum permissible radiation to 316 KW for channels 7 to 13 at any horizontal or vertical angle. However, the licensed ERP is based upon the radiation in the horizontal plane. Therefore the station license will show slightly less than maximum ERP when the beam tilt is optimized for maximum service and maximum signal directed at the angle of the horizon.

The New 12-Section Antenna and What It Does

The accompanying curves clearly demonstrate that antenna power gains in the order of 12 for an ERP of 316 kilowatts

will produce effective close-in coverage with strong signals of 100 mv/m or more out to the distance of intersection with the FCC curve for a dipole vertical pattern.

An unequal power division within the antenna is used to fill-in the first minima below the horizontal and to provide greater uniformity of the received signal. Beam-tilt is optional for signal improvement.

High-Gain Antennas for Low Power Stations

The "Field Strength versus Distance" data contained in Figs. 1 through 5 is based upon an ERP of 316 KW. Assuming average values of transmission line loss this will require a 50 KW transmitter operating at less than maximum ratings. Where economics dictate low power transmitters and where stations will commence operation with an interim power less than maximum

performance must be examined for a lower ERP. The Field Strength shown in the preceding curves may be adjusted to any ERP by a factor equal to the square root of the station ERP divided by 316. Figs. 6 through 10 present the same information for an ERP of 100 KW.

It will be noted that a signal in excess of the FCC Minimum for Principle City Coverage can be achieved to a distance of beyond 10 miles with an antenna height of 500 feet and with very low values of ERP. This will permit operation with a 2 KW transmitter and in many cases minimum requirements will be met with a 500 watt transmitter. The use of a high-gain antenna will provide an effective signal in excess of the FCC minimum requirements for low power transmitters and will permit achieving the maximum possible service area with the available transmitter power.

FIG. 10. (100 KW, ERP.) Coverage obtained with 12-Section High Gain Antenna at 1500 ft. height, 0° beam tilt and 70/30 power split.

FIG. 11. (100 KW, ERP.) Coverage obtained with 12-Section Antenna at 1000 ft. height, 1° beam tilt and 70/30 power split.

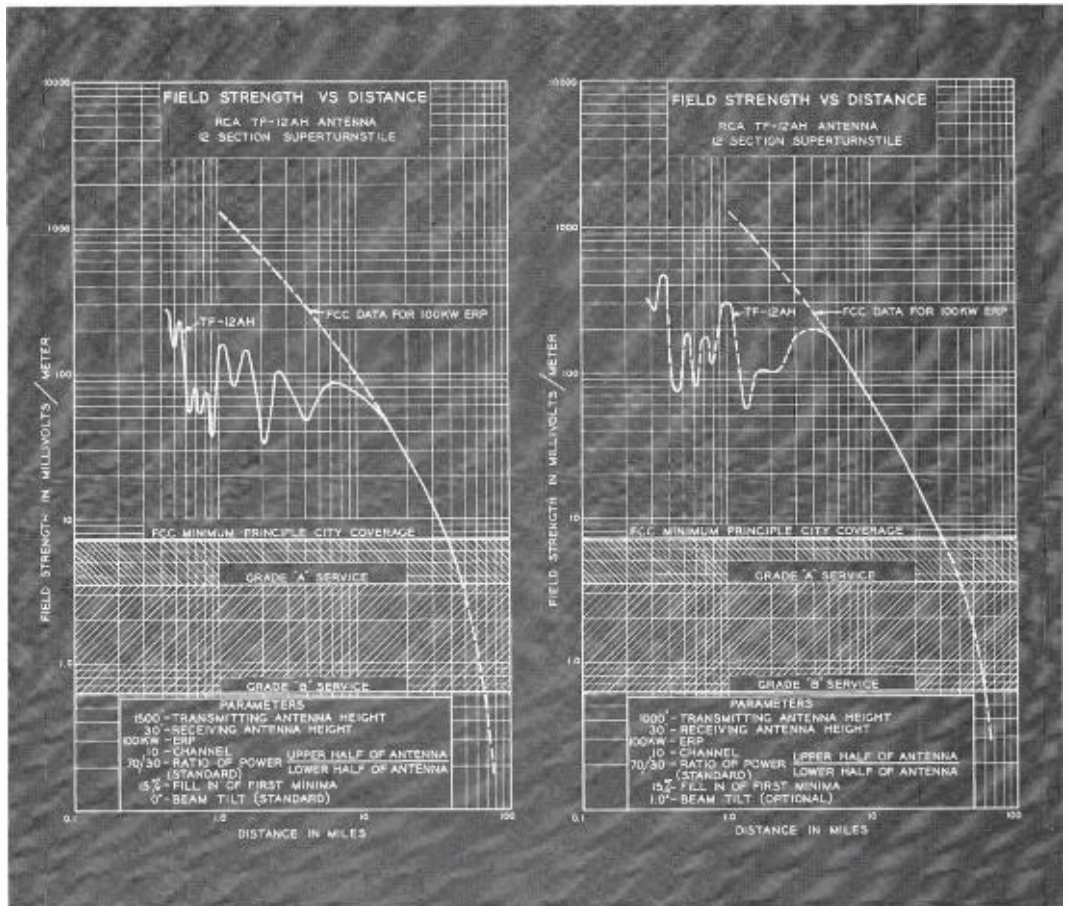

DIPLEXERS AND THE VHF FILTERPLEXER

By I. E. GOLDSTEIN and H. E. KING

Broadcast Section, Engineering Products Department

In the early days of television broadcasting, the simultaneous transmission of visual and aural signals was accomplished by using two separate antennas. As the television art progressed, notch-type diplexers, employing frequency-selective networks, were developed to permit radiation of the visual and aural transmitter outputs from a single antenna.¹ The development of the turnstile antenna with its two-line feed required the use of the bridge type of diplexer,² which permits the double use of the antenna by both visual and aural transmitters without interaction between the

two signals. Constant-impedance notch diplexers have been developed to provide greatly improved performance—their features will be presented as this article progresses.

Bridge Diplexers

The type of diplexer most used in television broadcasting today is the bridge type. This is the type generally used with the Superturnstile Antenna which has equal input impedances to the two halves (N-S and E-W sides) of the antenna. Fig. 1 shows that the diplexer, together with the antenna circuit, is equivalent to a Wheatstone Bridge circuit. The two equal resistive arms of the bridge represent the N-S and E-W sides of the antenna, respectively, while the diplexer contains the two equal reactive arms. The visual and aural inputs are connected as shown; and from each, the power divides equally to feed to the two sides of the antenna without interaction between visual and aural. Note that an important feature of this type of diplexer is the ability to transmit visual and aural r-f energy of the same frequency; thus, the upper visual sideband at 4.5 megacycles modulation is the same as the aural carrier frequency, but both are transmitted without interaction. Fig. 2 shows the inner conductor diagram of the diplexer and a Superturnstile Antenna.

The insertion loss of the bridge type diplexer is very low and is in the order of 0.1%. This is due to the fact that no tuned traps or other circuits carrying a high circulating current are used in the diplexer.

The construction of the coaxial bridge type, as shown in Fig. 1, is based on the split balun in which the outer conductor of a coaxial line is split for a quarter wavelength with the inner conductor connected to one side of the end of the split section. The two ends of the split section assume

opposite polarities; therefore, the single-ended input is thus converted to a double-ended circuit. This outer conductor is surrounded by a coaxial shield which forms the new electrical outer conductor. The aural input circuit inner conductor is connected to the crotch of the split section so that aural energy flows along as on two parallel conductors connected push-push.

The bridge diplexer, with its unique design, is capable of performing several functions.

1. Transforms the visual signal from single-ended to double-ended output.

¹ L. J. Wolf, "High Gain and Directional Antennas for Television Broadcasting", BROADCAST NEWS, Vol. 58.

² C. Gillam, "The Diplexer", Wireless World, March, 1950.

FIG. 2. Bridge diplexing circuit with Superturnstile Antenna. Reactive arms, A and B (split sleeves of Fig. 1), and resistive arms, C and D, of antenna form balanced Wheatstone Bridge.

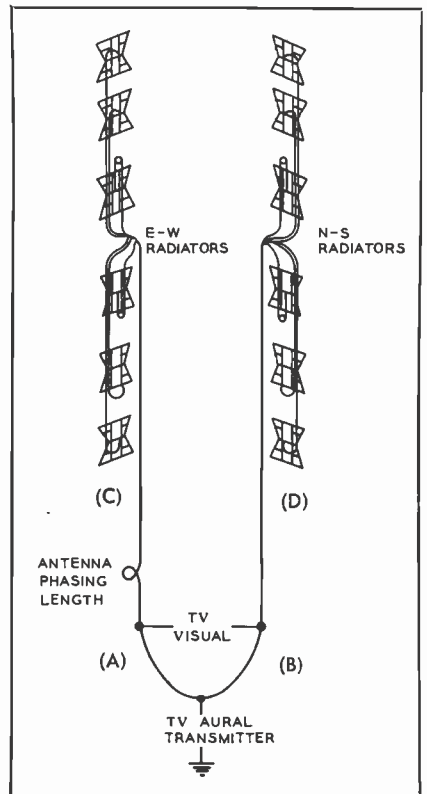
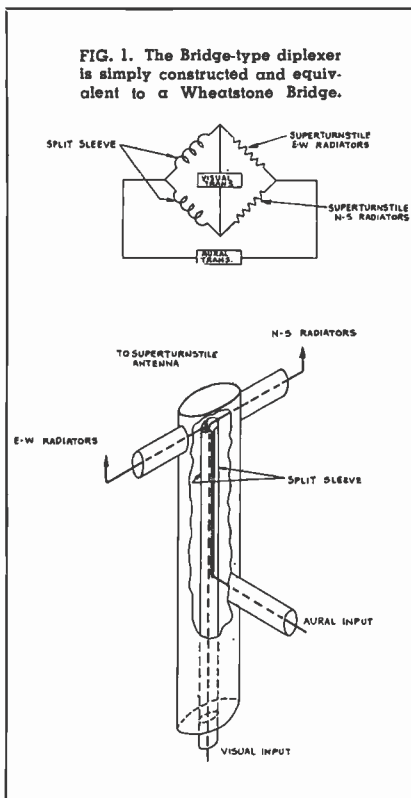

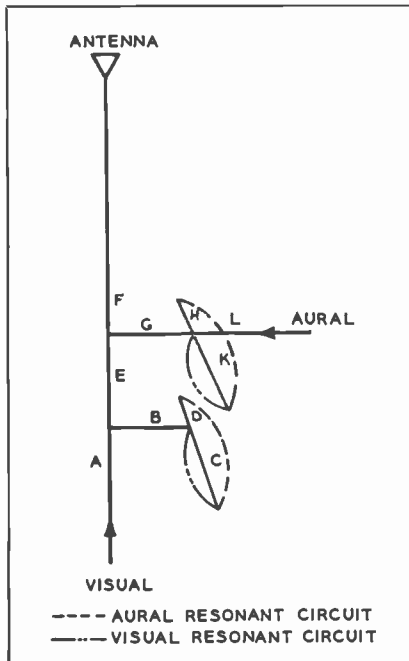

FIG. 3. Notch diplexing circuit. At aural frequency, lines G, H, K, B, D, C, etc., form matched circuit from aural input to antenna with visual input short-circuited to prevent loss of aural energy into visual transmitter. At visual frequency band (except at 4.5 mc above visual carrier), these same lines form matched circuit from visual input to antenna with aural input short-circuited. Thus visual characteristic is constant except for notch at 4.5 mcs in attenuation vs. frequency characteristic.

2. Divides aural power equally between two loads.
3. Forms one-half of a bridge circuit (of which the N-S and E-W portion of the Superturnstile Antenna form the other half).
4. By means of the bridge circuit, it permits simultaneous transmission of visual and aural signals into one antenna.

When the same circuit is used to perform the first three functions named above, it is known as a bridge-balun. The word "balun" is a coined word derived from the words "balanced-to-unbalanced". This circuit is used in this manner for power-equalizing, constant-impedance notch diplexing, vestigial sideband filters, and filterplexers, as described below.

Diplexers for Single Line Feed to Antenna

With the advent of new antenna systems requiring a single line input such as Super-gain Antennas, notch-type diplexers (Fig.

3) were found to be necessary to allow simultaneous feeding of both sound and picture signals through one transmission line to the antenna. The early notch-type technique, which utilized frequency selective circuits, was limited in performance by poor input impedance characteristics—especially in the high frequency region of the channel—and the associated poor amplitude and phase characteristics.

Fig. 3 shows the schematic diagram of the typical early notch-type diplexer. The curved lines depict the voltage distribution along the transmission line elements or stubs to yield the sound notch. Stubs at position ABE are displaced a quarter wave at the picture carrier frequency from stubs EFG to increase the bandwidth of the picture input using the theory of conjugate impedances, whereby the reactance at point A will be approximately equal and opposite in sign a quarter wave down the transmission line toward the generator. Thus the reactance terms will approximately cancel out near the frequency that is a quarter

wave and, as the frequency deviates from picture carrier, the reactance terms will not cancel out as well, thus causing poor input impedance characteristics.

A typical measured input impedance of this notch diplexer is drawn in Fig. 4 as Curve A. This curve assumes that the antenna is matched to the transmission line, and that looking into the sound transmitter from Line L (see Fig. 3), the impedance is 51.5 ohms. However, looking back into the aural transmitter, the impedance varies with the tuning of the final amplifier, and in order to fulfill the requirement of 51.5 ohms on the aural input, selected lengths of transmission lines or additional stubs between the notch diplexer and aural transmitter will be required. Even with the proper choice of transmission line lengths, the tuning of the sound transmitter will usually cause interaction to the picture pass band characteristics. Curve B illustrates possible defective impedance characteristics when the sound line is not terminated in 51.5 ohms. Curve C of Fig. 4

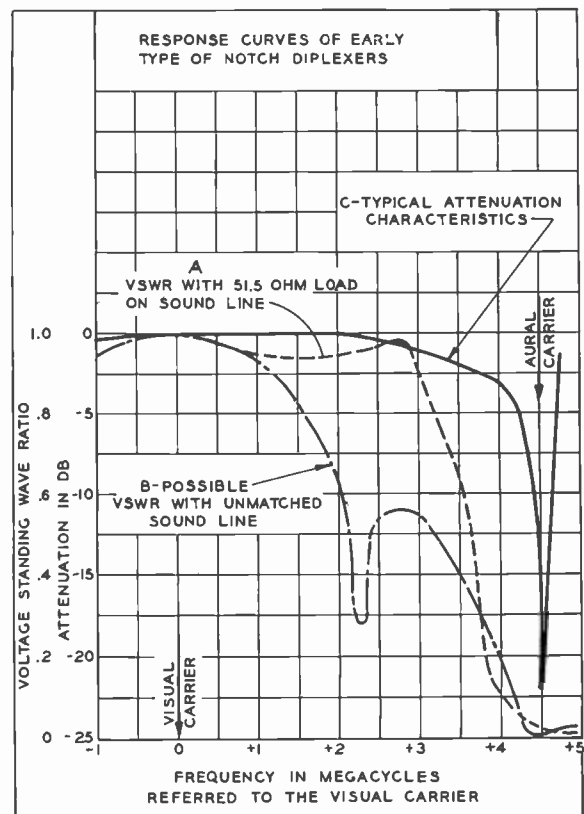

FIG. 4. Response curves of early type notch diplexers. Curve A: Attenuation characteristics when the sound transmitter output viewed from notch diplexer appears as 51.5 ohms. Curve B: Possible attenuation characteristics for the condition when sound transmitter does not appear as 51.5 ohms. Since sound transmitter is rarely matched (as in Curve A), Curve B is the more likely situation. Curve C: Poor high frequency response is indicated in the attenuation curve.

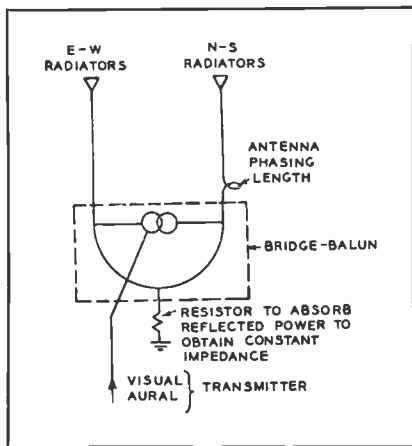

FIG. 5. Power equalizer circuit is used to obtain improved bandwidth for antennas that otherwise have a relatively poor impedance characteristics. The bridge-balun is equivalent to bridge circuit.

shows typical attenuation characteristics of the visual input terminal with the sound notch in. Note that the insertion loss or attenuation at the frequency 4 megacycles above the picture carrier is greater than 5 db, indicating an undesirable pass-band characteristic for the high quality video transmission required for present day television.

The Power Equalizer³ for Broad Band Impedance Characteristics

The present practice in antenna engineering is to make the impedance of the radiators as broad band as possible by experimental means. To obtain even greater bandwidths when the antenna's bandwidths are too narrow for television broadcasting, power equalizing³ can be used. Fig. 5 can be used to show the action of the power equalizer which is essentially a bridge-balun. The N-S and E-W sides of the antenna can usually be made symmetrical and, hence, the reflection (due to a poor voltage standing wave ratio) will be equal. However, the reflected components of the right hand side will pass through the horizontal phasing loop of 90° twice, and thus be retarded by 180°. Since the reflected components are now out of phase because of the 180° phase difference, they will not re-enter the picture transmitter but pass on down the sound line. Replacing the

³ R. W. Masters, "A Power Equalizing Network for Antennas", Proceedings of IRE, Page 735, July, 1949.

sound line with an absorbing resistor will prevent the reflected energy from being radiated. The prevention of reflected energy from entering the visual line represents a constant impedance circuit.

Use of the power equalizer with the Supergain Antenna imposes the requirement of a single-line feeder and a notch diplexer.

The principle of obtaining constant impedance by having identical circuit impedances and fed also in quadrature was applied to filter networks, and resulted in the development of a constant-impedance notch diplexer.

The Constant-Impedance Notch Diplexer

The constant-impedance notch diplexer technique (as shown in Fig. 6) involves the connection of bridge-baluns A and B by two equal lengths of coaxial transmission line and includes two high-Q cavity circuits which are spaced one-quarter wavelength apart—one on each of the two interconnecting coaxial transmission lines.

The sound transmitter is fed into the network (as shown on the right hand side of Fig. 6) in phase on both coaxial lines. The cavities are tuned to the sound carrier frequency and are arranged to present an electrical short circuit at the points C. The reflection, due to the electrical short circuit, will be equal except that the reflected components of the upper transmission line will have traveled a path length difference

of 180°, as compared to the lower transmission line. Since the reflected sound components are now out of phase by 180°, they will not re-enter the sound transmitter line but will emerge to the antenna in a single coaxial transmission line. The dashed lines of Fig. 6 depict the flow of sound energy. Leakage of sound power beyond the point C of Fig. 6, because of the fact that the electrical short circuit is not perfect, is absorbed in the absorbing resistor, thus assuring isolation of the sound and picture transmitter and a constant impedance into the sound line.

The visual signal is fed into the bridge-balun, A, and emerges from the terminal in push-pull or 180° out of phase. Since the distance to the other bridge-balun, B, through each of the interconnecting coaxial transmission lines is equal, the picture signal will reach the terminals of bridge-balun, B, in push-pull (180° out of phase) and the output will be fed to the single coaxial line to the antenna. The long-and-short dashed lines of Fig. 6 indicate the flow of visual energy.

The cavities will present band-pass characteristics as shown in Curve A of Fig. 8. Up to approximately 4 megacycles above the picture-carrier frequency, the picture upper sideband frequencies will encounter no reflection from the characteristics of the sound traps and will reach the antenna directly. At the sound carrier frequency region, the picture side bands are reflected and absorbed in the absorbing resistor in

FIG. 6. Constant-Impedance-Notch Diplexer Circuit facilitates the simultaneous use of a single antenna, with a single line feed for both the visual and aural signals, while maintaining load on transmitter that is constant for carrier and all sideband frequencies.

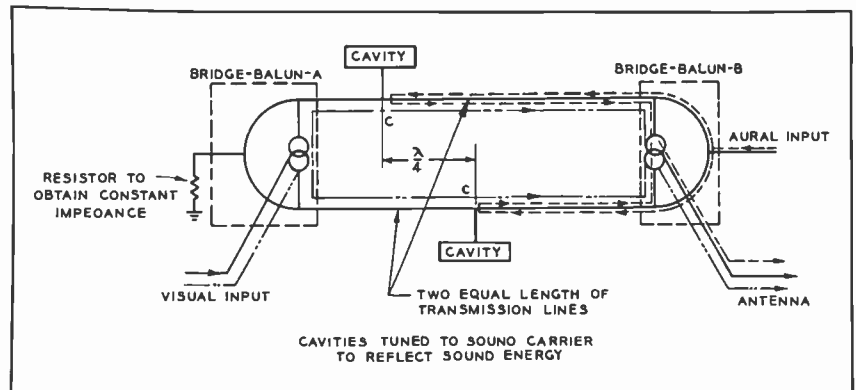

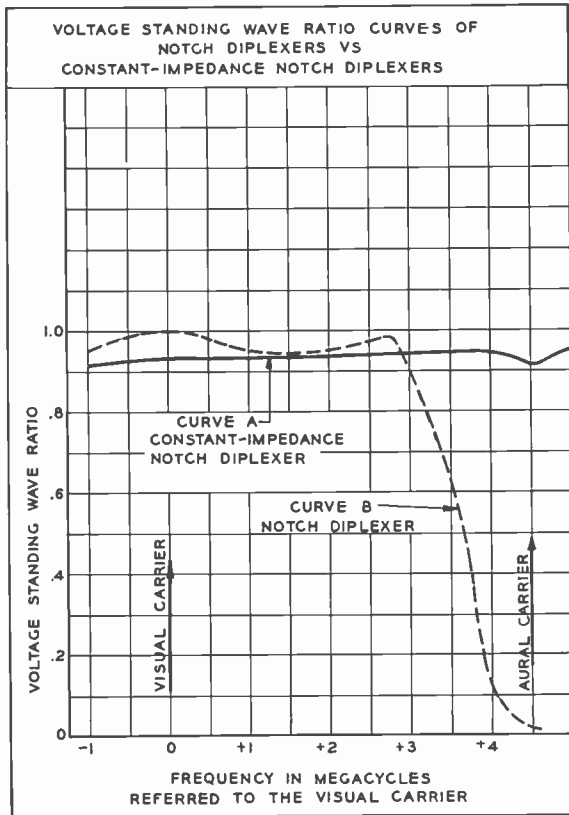

FIG. 7. Comparison of the two types of notch diplexers. Curve A: The very flat voltage standing wave ratio response indicates excellent isolation and constant impedance apparent only in the Constant-Impedance Notch Diplexer. Curve B: The relatively poor response of the early type of notch diplexers is shown. The impedance response begins to drop at 3 mcs above the picture carrier.

the wrong polarity to enter the picture transmitter. Reflected energy of the picture sidebands does not re-enter the picture transmitter either because the reflected visual energy is not of the proper phase. Since no sound or reflected picture energy enters the picture transmitter, it naturally presents a constant impedance and good isolation is maintained.

In making a direct comparison of the notch diplexer vs. the constant-impedance notch diplexer, see Curve B of Fig. 7. Curve B is the visual input VSWR of the notch diplexer under the ideal condition of a matched load on the sound line and, as was mentioned in reference to Fig. 4, Curve B, a bad impedance could be obtained under certain tuning conditions of the sound transmitter.

Fig. 7 shows the definite improvement of the constant-impedance notch diplexer as far as impedance is concerned.

a manner similar to the power equalizer. The elimination of energy being returned to the picture input terminals assures constant visual input impedance.

Improved Performance Characteristics

The constant-impedance notch diplexer technique just described presents highly improved impedance, attenuation, and isolation characteristics over the early type notch diplexers as follows:

1. Constant-Impedance and Transmitter Isolation

Fig. 7, Curve A, illustrates the excellent impedance characteristics of the new constant-impedance notch diplexer. The constant impedance is maintained regardless of the sound line termination whether open-circuit, short-circuit or terminated with 51.5 ohms. This can be visualized by reviewing Fig. 6; the sound power that is not reflected by the cavities will merely pass on and be absorbed by the resistor since it is of

FIG. 8. Comparison of attenuation curves of the two types of notch diplexers. Curve A: The very flat frequency response is ideal for high quality of video transmission. Curve is flat within 1 db, out to 4 mcs above picture carrier for Constant-Impedance Notch Diplexer. Curve B: Response of the notch diplexer begins to drop off at approximately 3 mcs, which is undesirable.

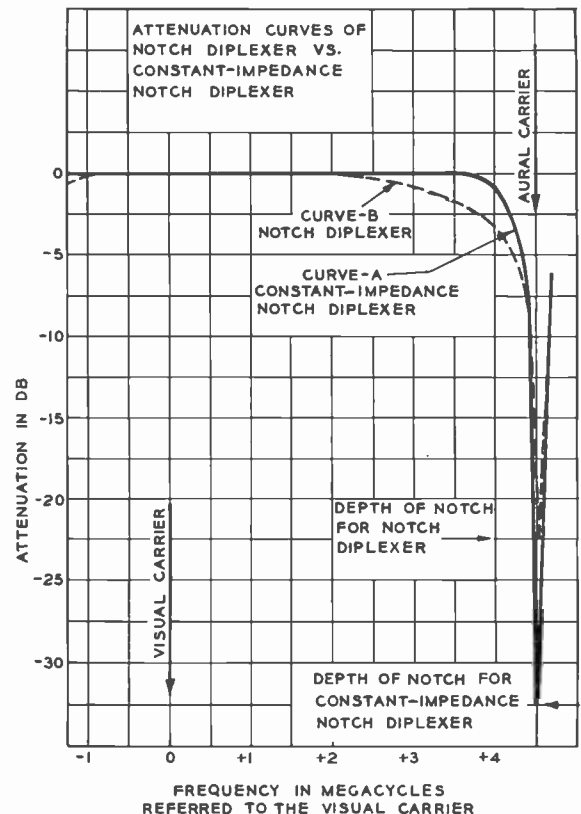

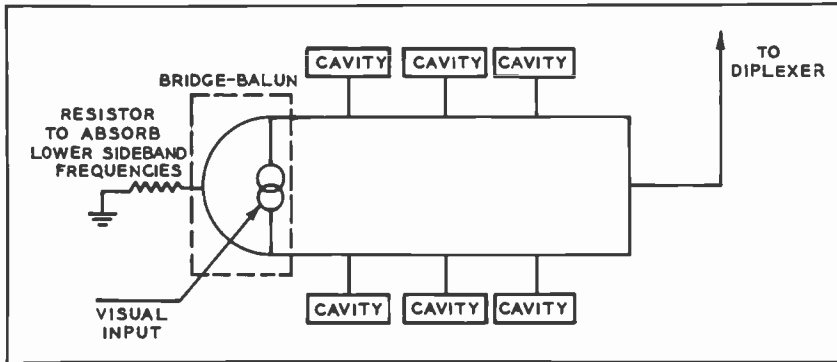

FIG. 9. Vestigial Sideband Filter Circuit using a Bridge-Balun. The cavities are trap circuits, used to short-circuit the parallel lines at selected frequencies in the reject region.

2. Attenuation Characteristics

In the constant-impedance notch diplexer, not only does the impedance improve considerably, but the attenuation response is improved accordingly. Fig. 8. Curve A, depicts the excellent band pass characteristics with an insertion loss of less than 1 db out to 4 megacycles above the picture carrier frequency and, at the sound notch, approximately 33 db down. Curve B shows the relatively poor response and a sound notch of only 25 db down for the notch diplexer. A greater depth of the sound notch represents increased efficiency of the sound line and increased isolation between the sound and picture transmitter.

The band pass characteristics of the constant-impedance notch diplexer are required for present day high quality black-and-white and color television broadcasting.

3. Increased Power Rating

With the frequency selective circuits exposed to only half of the total input power since the power splits off as it leaves the bridge-balun units, it is possible to increase the power rating as compared to the early notch-type diplexer where the frequency selective circuits are carrying the total power.

Vestigial Sideband Filter Uses Constant-Impedance Techniques

From the development of the constant-impedance notch diplexer, its techniques

have been extended successfully to Vestigial Sideband Filter (VHF only) and combination constant-impedance sideband filters and constant-impedance notch diplexers—known as Filterplexers—for both UHF and VHF applications. The Vestigial Sideband Filter (seen in Fig. 9) includes three filter circuits (which are cavities) attached on each of the two interconnecting transmission lines. These filter elements are tuned for different reactance slopes and resonant frequencies which are combined to yield the vestigial sideband response characteristics as recommended by the RTMA and FCC. Fig. 10 shows the typical character-

istics for the new 25-Kilowatt Vestigial Side Band Filter.

The signal from the visual transmitter is fed into the bridge-balun and goes directly to the antenna terminals without any attenuation because the filter circuit causes no reflections of the picture carrier and its upper sideband frequencies. Reflections of lower sideband frequencies, due to the vestigial sideband filter characteristics, are absorbed in the reject load, thus assuring a constant input impedance. Since no sound carrier is involved, the bridge-balun, through which the sound signal would normally be fed, is eliminated and replaced by a simple T.

Constant-Impedance Combination Vestigial Sideband Filter and Notch Diplexer

RCA's VHF* Filterplexer (Fig. 11) represents a combination vestigial sideband filter and constant-impedance notch diplexer, assembled as a single unit which features diplexing and vestigial sideband filter characteristics. The Filterplexer includes two bridge-baluns, A and B (as shown in Fig. 11), connected by two equal lengths of interconnecting coaxial transmis-

* Also used for UHF.

FIG. 10. The Vestigial Sideband Filter frequency response meets the FCC and the RTMA specifications. The attenuation is flat to within 1 db out to 4 mcs.

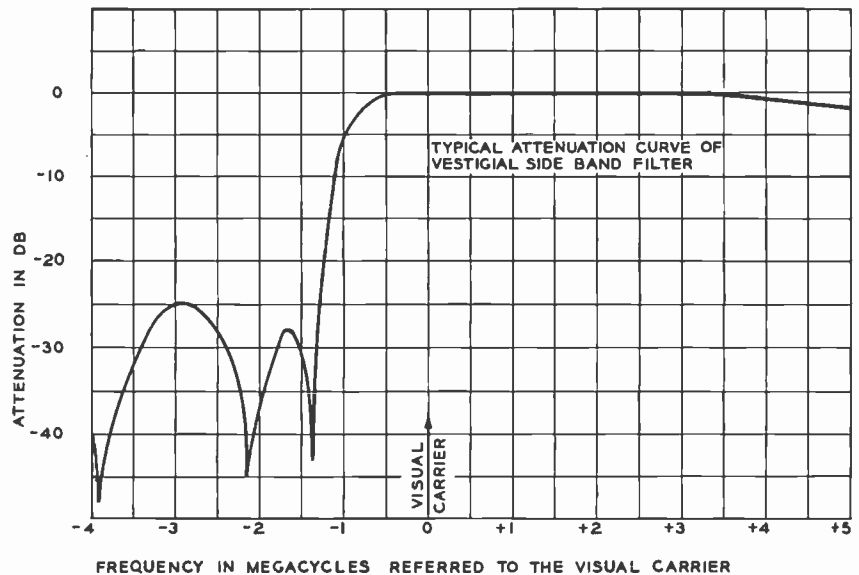

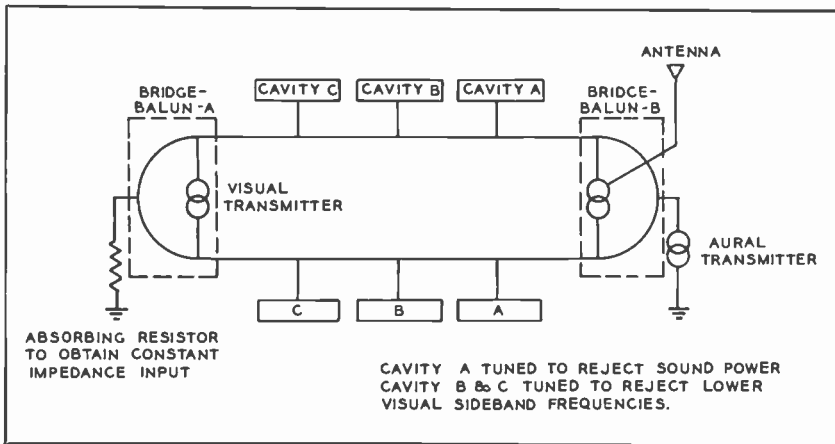

FIG. 11. Filterplexer circuit. The techniques of the Vestigial Sideband Filter (Fig. 9) and the Constant-Impedance Notch Diplexer (Fig. 6) were combined to form one unit which connects the visual and aural transmitters to a common antenna feedline without interaction or cross talk.

sion line and three filter circuits (cavities) on each of the two interconnecting coaxial transmission lines.

The operation of the Filterplexer is similar to the constant-impedance notch diplexer and also the vestigial sideband filter explained previously. Referring to Fig. 11, note that Cavity No. A is tuned to the sound frequency, and thus it takes the same action as the cavities explained in Fig. 6. Leakage of sound power beyond this point is discharged through the terminating resistor.

Cavity Nos. B and C are used to obtain the vestigial response characteristics of the visual input. As in the constant-impedance notch diplexer and the vestigial sideband filter, the visual signal is fed into the bridge-balun circuit and travels directly to the antenna input terminals.

With the combination of the constant-impedance notch diplexer and vestigial sideband filter, RCA engineers have been capable of combining the high quality performance characteristics of each unit into the Filterplexer, as displayed in Fig. 12. The insertion loss is less than 1 db out to a point 4 megacycles above the picture carrier frequency, which represents a very desirable band-pass characteristic. The vestigial sideband characteristics are also maintained by having the lower side band frequencies attenuated to more than 20 db

from the low edge of the channel (1.25 megacycles) to 4.25 megacycles below the picture carrier.

Because Filterplexer units are built at lower costs than the combined cost of the Constant-Impedance Notch Diplexer and Vestigial Sideband Filter units, appreciable savings are realized when Filterplexer units are used for TV installations with single line feed into the antenna.

The Constant-Impedance Notch Diplexer, Vestigial Sideband Filter, and Filterplexer are designed for wall, ceiling, or floor mounting in the transmitter building. The frequency band for which each unit is to be used determines the sizes.

Conclusions

With the advancement of television broadcasting, new standards using higher video modulation frequencies and with new antennas using single line feed to the antennas, the Constant-Impedance Notch Diplexer was developed. The early type of notch diplexer had the undesirable characteristic that tuning of the aural transmitter output circuit often affected the response of the visual output circuit and it had a narrower pass-band response.

The Constant-Impedance Notch Diplexer eliminates these difficulties; the visual and aural circuits do not interact and the visual input voltage standing wave ratio is constant over the whole range of modulation frequencies. From the Constant-Impedance Notch Diplexer, other circuits such as the Vestigial Side Band Filter and the Filterplexer were designed.

FIG. 12. The high quality performance characteristics of the Vestigial Sideband Filter and the Constant-Impedance Notch Diplexer are combined to yield the Filterplexer. The lower sidebands are attenuated more than 20 db. The pass-band is constant within 1 db up to 4 mcs. High efficiency of the aural transmitter is provided with the deep notch.

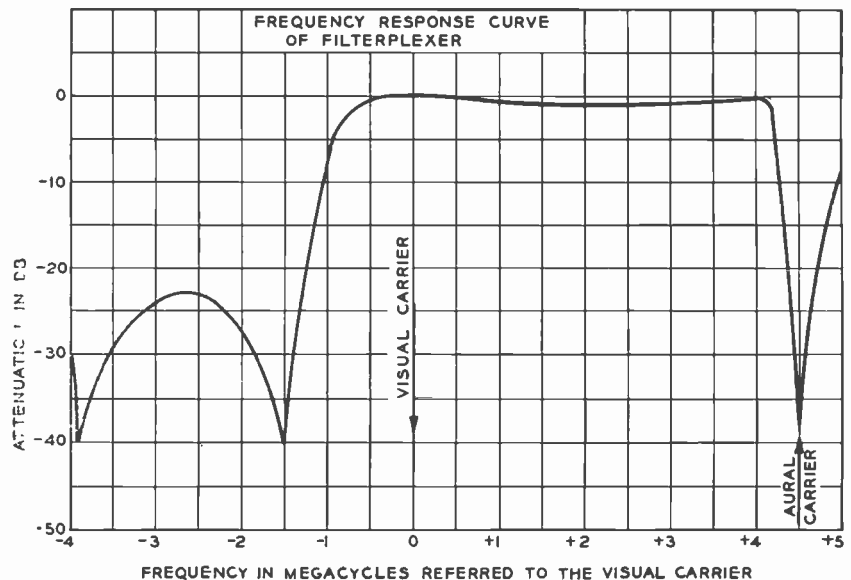

WBT'S NEW BTA-50F1 TRANSMITTER INSTALLATION

By
F. R. BROWN
&
M. J. MINOR

Station WBT, Charlotte, N. C.

When the decision was made by the Jefferson Standard Broadcasting Co. of Charlotte, N. C., to purchase and install a new BTA-50F1 Transmitter, it was also decided to add a wing on to the southeast side of the transmitter building, just large enough to accommodate the new facility. Fig. 4 shows a floor plan of the new section.

It was deemed advisable to add this new section to our transmitter housing facilities in order to insure uninterrupted broadcast operations during the period of installation of the new equipment. Con-

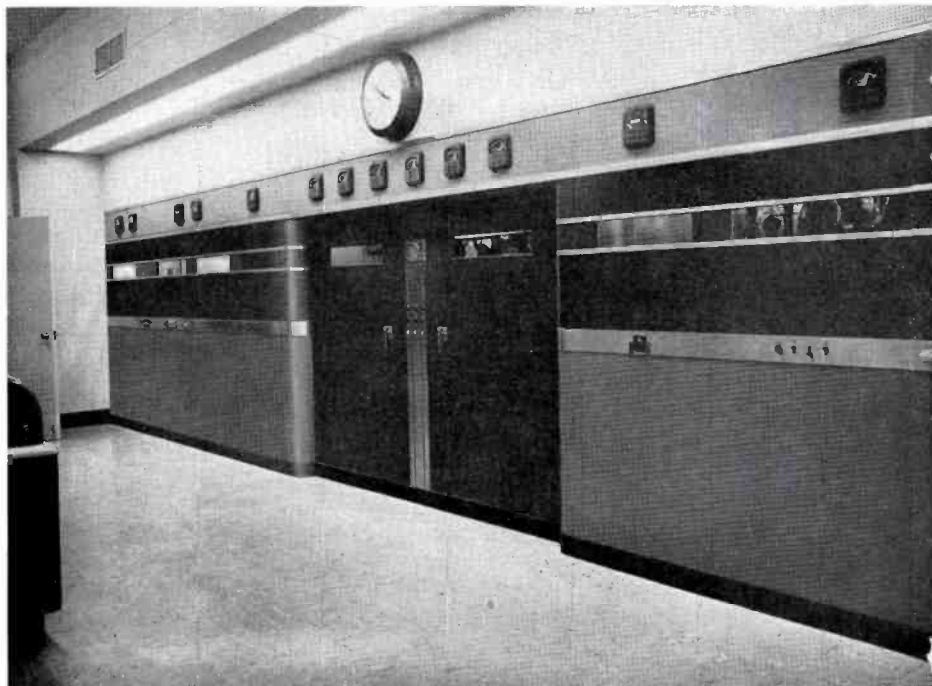

FIG. 1. WBT's new RCA BTA-50F1 transmitter.



tinuous service could not be guaranteed if the old 50B had been removed section by section and replaced into operation during the limited time between sign-off and sign-on each night. And too, spare parts and spare tubes, etc. would require greater storage space for future economic operations; therefore, the decision to add to the old building was a wise one.

For the purpose of discussion, the addition to the building should be divided into three sections:

1. The section housing the transmitter and power control equipment.
2. The section housing the main blowers and air filters.
3. The transformer vault.

A thirty-three foot section of the southeast wall of the old building was removed for the purpose of giving complete observation to the new BTA-50F1 front panel.

FIG. 2. The Charlotte, N. C. location of WBT's new RCA BTA-50F1 transmitter.

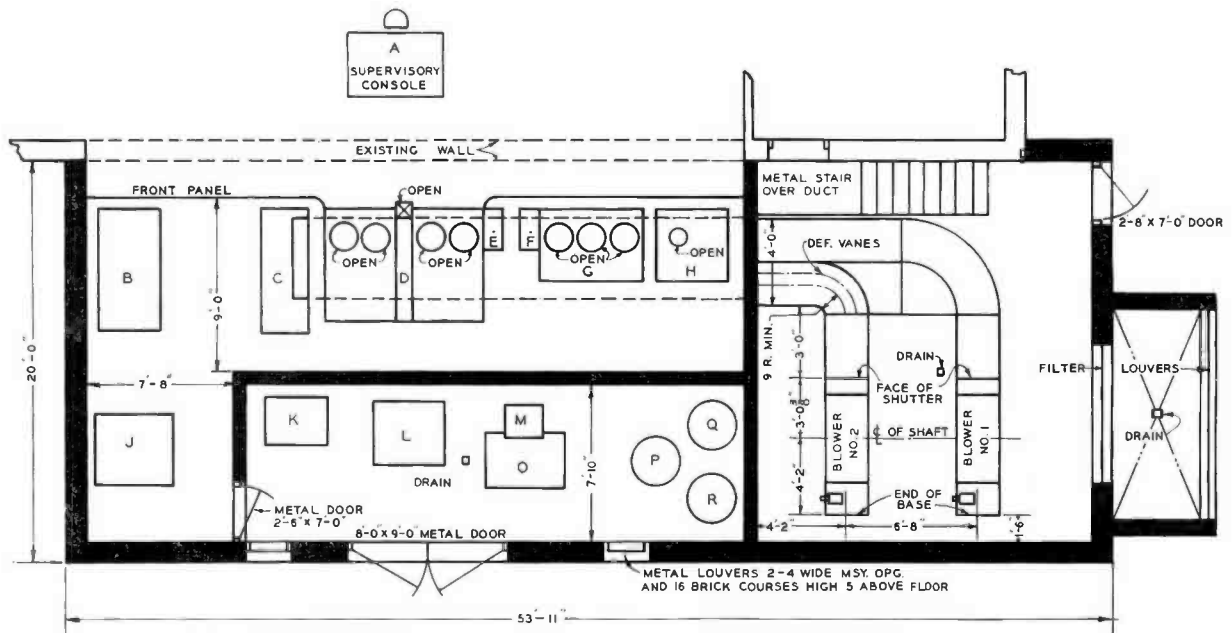

FIG. 3.

- (A)—Supervisory Console
- (B)—Control Distribution Unit
- (C)—Main Rectifier
- (D)—Power Amplifier

- (E)—Filament Power Unit for P.A.
- (F)—Filament Power Unit Modulator
- (G)—Main Modulator Unit
- (H)—Exciter Unit
- (J)—Switch Gear Unit
- (K)—Filter Reactor
- (L)—Main Modulator Reactor
- (M)—Blocking Capacitor
- (O)—Main Modulator Transformer
- (P), (Q), (R)—Plate Transformers

In order to accomplish this structural design it was necessary to have a specially designed steel "I" beam fabricated to span the thirty-three foot section of the wall to support the roof of the building on this side and at the same time be capable of supporting the weight of the roof of the new section. The walls, floor and ceiling of the addition were made to blend into the old building without any indication of where the old building stops and the new section starts.

The manner in which the blowers were installed was somewhat unique in that as simple a duct system as possible was desirable. Also the space in which they were to be installed was limited. In Fig. 4 you will note that both blowers were installed parallel to each other and at a 90 degree angle from the direction in which the air volume would be delivered.

Due to the physical layout of the ground under which the building was being constructed, it was desirable to construct a plenum chamber immediately beneath the floor of the transmitter. This chamber could be made air tight and pressurized from the output of the blowers, thereby eliminating the necessity for the complicated duct work to deliver air to the various parts of the transmitter. At the same time, the plenum chamber would provide equal air pressure to all parts of the transmitter. The air intake to the blower room is through 18 filters. A normal complement of filters as

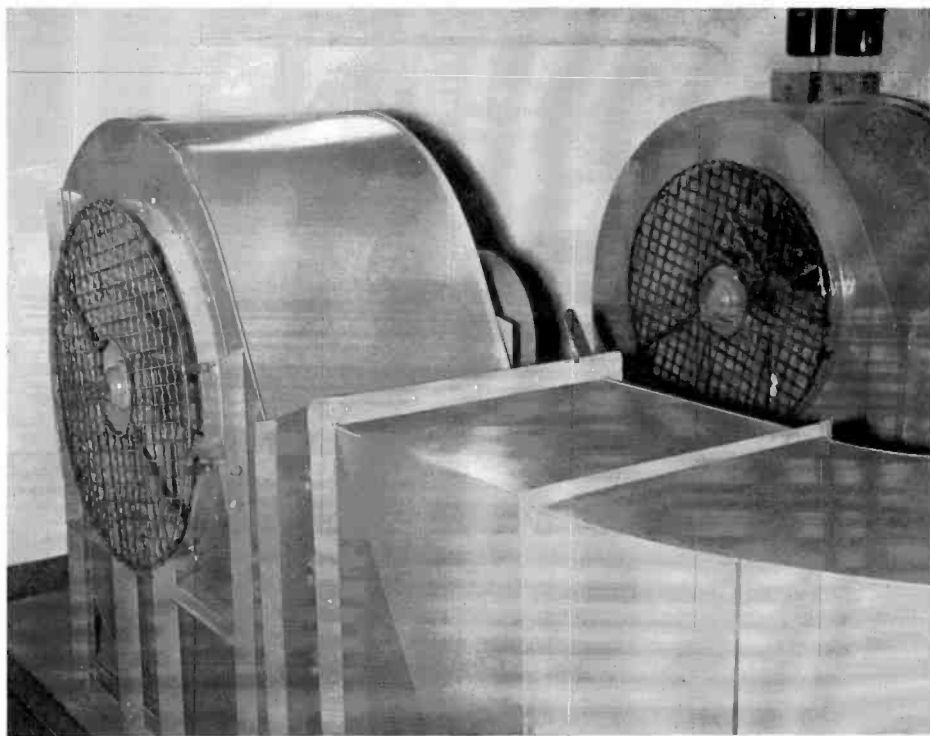

FIG. 4. Main cooling blowers.

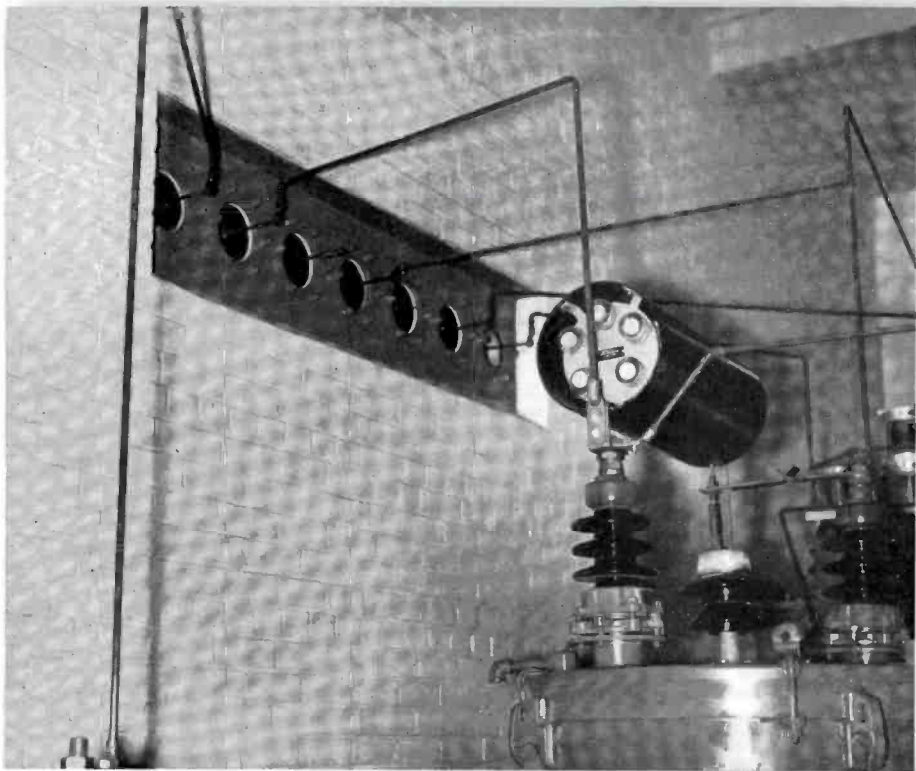

FIG. 5 (left). Specially constructed metal plate with bowl insulators mounted. Installed in wall between the transformer vault and transmitter room.

FIG. 6 (below). Grant Carey, WBT satellite and AM transmitter Supervisor at WBT's RCA BTA-50F1 transmitter.

specified by RCA is only 12. The advantages of increasing the number of filters is to provide a greater air volume and also increase the time in which the filters could be used before cleaning.

There is a rain shed provided on the input side of the filters to prevent blowing rains from water-logging the filters and reduce moisture content getting to the transmitter tubes.

The plate transformers, modulation transformer, modulation reactor and filter reactor were installed in the transformer vault. It was provided with extra wide loading doors in order to get the large sections of the transmitter in the building. A separate ventilating system was provided so as to minimize the danger to other sections of the building due to fire hazards. All walls of this section were constructed of masonry. The floor and overhead ceiling are a poured reinforced concrete slab. Ventilating louvers at the floor level and in the roof are provided with a fusible link which, in the event of fire, would control the air circulation through the transformer vault. The Fire Underwriters Code was followed in every respect in the construction of the new addition to the building.

The necessary conduits were installed for all wiring to all units of the transmitter prior to pouring the concrete floor. There is a steel plate 6 feet long, 14½ inches wide and 3/16 inch thick installed



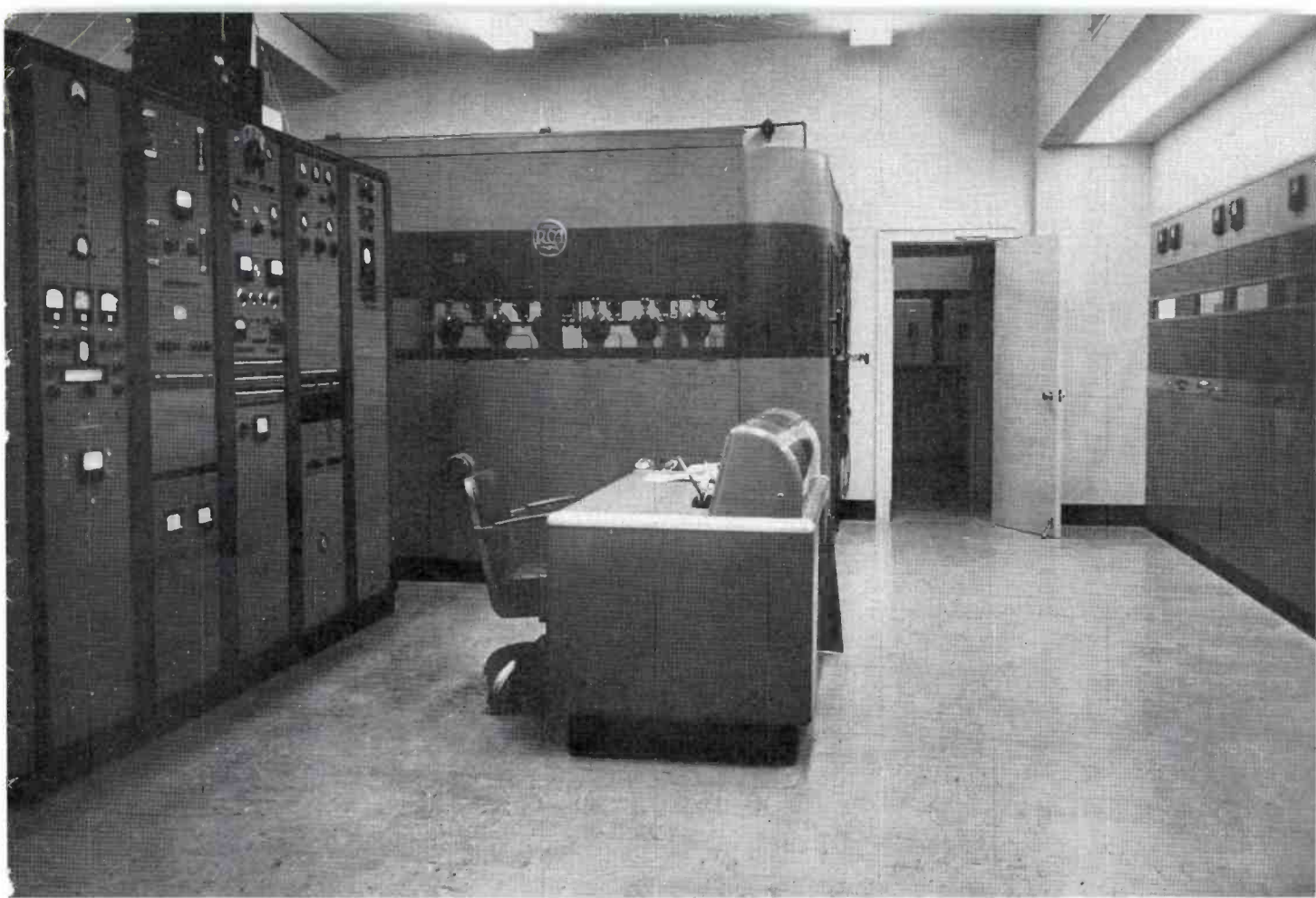

FIG. 7. Left: BR-84 Equipment Racks

Center: BTA-50F1 Operator Console
Center Background: Old RCA 50B Rectifier Panel

Extreme Right: Section of BTA-50F1 Front Panel

in the wall separating the transmitter room and the transformer vault 8 feet above the floor in which 7 bowl insulators are mounted. The insulators provide connections between the modulation transformer, modulator reactor, the filter reactor and the rectifier tubes and filter capacitors. These circuits are made rigid by the use of $\frac{1}{2}$ inch copper tubing as busses.

To accomplish the feeding of the signal to the input of the antenna system a transmission duct (or perhaps more appropriately named Coaxial Line) was designed by our local transmitter supervisor and built by a local Tin Shop out of $\frac{1}{16}$ inch copper plate. This duct is 10 inches by 6 inches, the interconductor is $\frac{1}{2}$ inch copper tubing and is supported on 6 inch standoff insulators spaced 3 feet apart. This duct or coaxial line is 51 feet long and makes two right angle turns from the power amplifier to the input antenna system. The power amplifier end of this duct is 17 inches by 18 inches. Where the inner-conductor connects to the output of the power amplifier a double loop 6 inches in diameter was made in this conductor.

Two pickup coils on standoff insulators are mounted near this loop. One pickup coil feeds the RCA BW-66E modulation monitor. The other pickup coil feeds the monitor rectifier, the output of which is fed to a monitor amplifier. Off-the-air monitoring is used at the station and therefore, this monitor rectifier is not used for this purpose except for emergency monitoring. Part of the rectified output of the monitor rectifier is also fed to the protective relay panel.

The monitor rectifier was mounted on the power amplifier unit on the same side but to the rear of the filament transformers. This location shortened the leads between the pickup coil and the monitor rectifier. The protective relay panel was mounted in the control and distribution unit behind the door housing the main filament contactor and immediately under the filament start switches.

Copper strapping 4 inches wide and $\frac{1}{16}$ inch thick was used to connect each section of the new equipment to the station's main ground. All ground strap conductors were

made as short as possible. Extreme care was taken in making ground connections to all equipment. Also brazed connections were made to the main station ground wherever possible.

It is well to note that every piece of metal such as reinforcing rods, supporting beams, conduits, etc., was brazed so as to form a continuous circuit to the main station ground. Precautionary measures were taken to prevent the formation of any closed metallic loops in the process of brazing these pieces of metal.

An air duct system was installed on the air output side of the transmitter for the purpose of providing heat to the building during the winter months. This feature is to conserve fuel for building heating purposes. The air output from the transmitter is diverted through ventilators in the roof during the warmer months of the year.

All wiring of the transmitter was under the direct supervision of our engineering staff and was virtually completed before the arrival of Mr. W. B. Fletcher, RCA Service Company's Engineer.



FIG. 1. The newly designed RCA "Commentator" Pressure Microphone, Type BK-1A may be used desk- or floor-stand mounted, or hand held. See Fig. 2.

A PRESSURE MICROPHONE FOR TELEVISION AND BROADCAST SERVICE

By

L. J. ANDERSON, Manager
Instrument and Loudspeaker Design
Communications and Sound Engineering

Microphones used in Television are subject to a great deal more handling and in many cases rougher handling than in Broadcast Service. This condition necessitates the use of microphones which are extremely rugged in construction. Microphones are moved about during programming, sometimes rapidly. These microphones must therefore be insensitive to air currents and mechanical shock. Stage sets are often noisy and for some conditions directional microphones are highly desirable in order to obtain an adequate signal to noise ratio. In many programs the microphone must either be entirely out of the picture or cleverly concealed.

Microphones of good Uni-directional characteristics have become fairly standard for the boom applications, while unobtrusive non-directional models lend themselves more readily to concealment. However, the slender models of this type are rather low in output level, except when used for close talking. There is therefore, a need for a rugged Pressure Type Microphone having a sensitivity and frequency response equivalent to that of the boom microphones for use in Television, as well as in Broadcasting.

The design of such a microphone presents many interesting problems, the solutions of which are based on experience, experiment and calculation. Since the problems are best discussed on the basis of an actual example the newly designed RCA Type BK-1A Pressure Microphone

shown in Figs. 1, 2 and 3, is used as an illustration.

A moving coil system¹ was chosen for the transducer because of the relatively high output levels obtainable for a given

¹ Wente & Thuras, Journal Acous. Soc. Amer. Vol. 3, No. 1, p. 44, 1931.

FIG. 2. Designed for rugged duty—the BK-1A made television history at the National Political Conventions.



size and weight and because of the inherent ruggedness. The theory is relatively simple. The value of the generated voltage may be obtained from the following expression:

$$(1) \quad e_o = \frac{Bl f_m}{Z_m}$$

where B = airgap flux density
 l = length of conductor in airgap
 f_m = the driving force
 Z_m = the mechanical impedance of the moving system
 e_o = the generated voltage

B and l are of course independent of frequency and the response-frequency characteristic of the microphone will be obtained by evaluating f_m/Z_m as a function of frequency.

Effect of Case Dimensions

For sound waves where the dimensions of the case are small compared to a wavelength

$$(2) \quad f_m = A_d p$$

A_d = the effective area of the diaphragm
 p = the free-field sound pressure

For higher frequencies, because of diffraction effects,² the sound pressure on the front of the microphone will rise with increasing frequency above the point at which the dimensions of microphone become an appreciable part of a wavelength. For a cylindrical shape, the pressure rise, for normal sound incidence on the end of the cylinder, reaches a maximum of 10 db at the center when the diameter of the cylinder is equal to a wavelength. Beyond this point the pressure falls to zero when the diameter is twice the wavelength. Actually the diaphragm occupies a small area rather than a point, at the center, and the diffraction effect is less drastic than the above data indicates.

The directional properties of the microphone are also a function of the diameter and to some extent the modification of the cylindrical body both as to shape and finite length. In general a 2-inch diameter microphone will be non-directional to about 1000 cycles and increasingly directional above that frequency. Listening tests have re-

peatedly shown that for microphones having such directional characteristics a rise in the axial response-frequency characteristic of about 4-6 db in the range from 2000 to 10,000 cycles is desirable. This being the case, a 2-inch diameter will be maximum for which f_m will remain within useful limits from 50 to 10,000 cycles.

The minimum diameter which the case may have will largely be determined by the specification established for the low frequency response and the output level. Smaller case diameters mean stiffer diaphragms and less space for magnet materials other things remaining equal. For the type BK-1A Pressure Microphone under consideration the low frequency cut-off

was set at 50 cycles, and the effective output level at -53 dbm for a sound pressure of 10 dynes per square centimeter. Using presently available materials it is not possible to meet these specifications with a microphone much less than 2 inches in diameter.

Evaluation of Z_m

Since f_m plotted with respect to frequency differs for all practical purposes from e_o by a constant, the microphone will have the desired response-frequency characteristic if Z_m is made a constant with respect to frequency. This is accomplished by coupling to the diaphragm acoustic elements as shown in the equivalent circuit, Fig. 4.

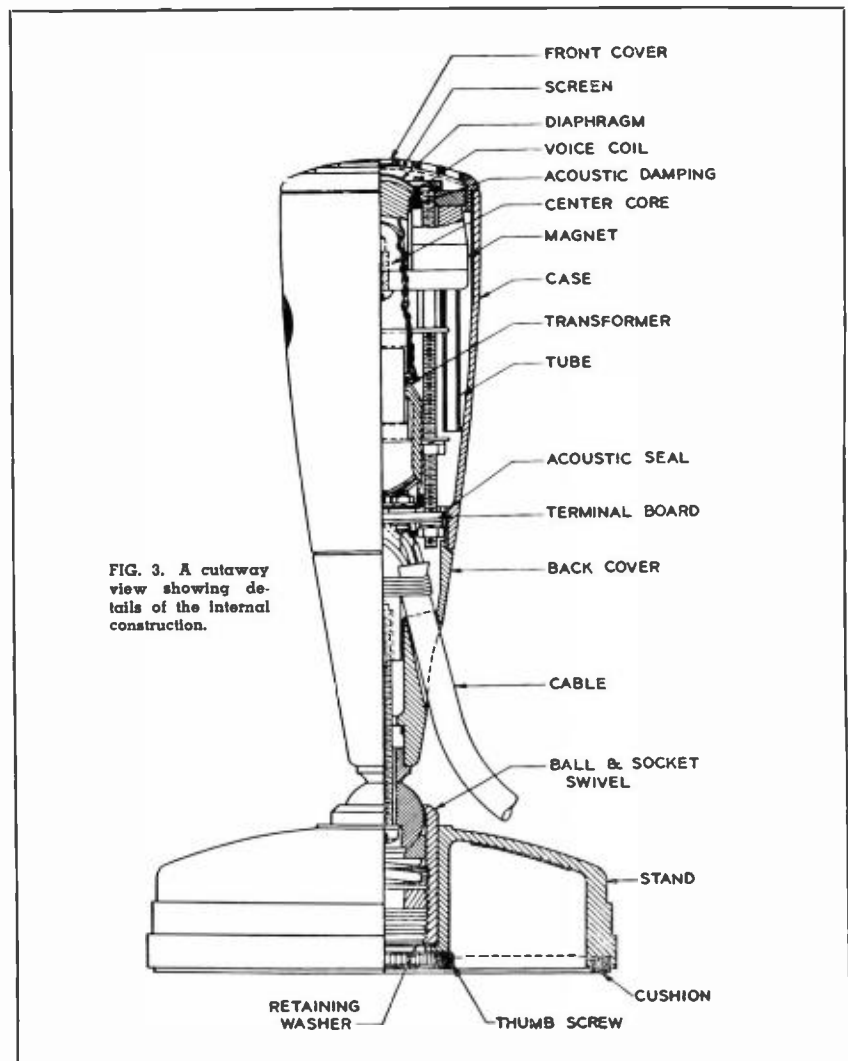

FIG. 3. A cutaway view showing details of the internal construction.

² Muller, Black & Dunn, Journal Acous. Soc. Amer. Vol. 10, No. 1, p. 6, 1938.

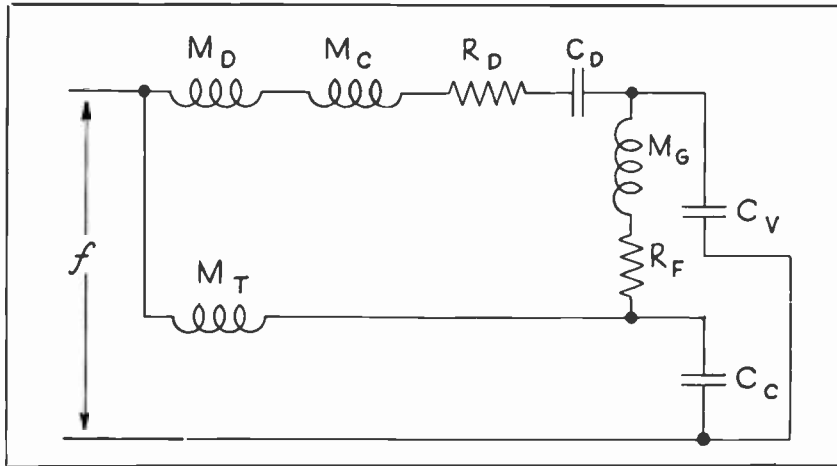

FIG. 4. Electrical analogue of Type BK-1A Microphone.

³The problem is complicated by the many variables and calculations that are both difficult and time consuming. For adjustments to the system and evaluating the results, the electrical analogue is an extremely useful tool and may actually be set up using electrical components which are variable to the desired degree. The following general criteria can however be stated. The stiffness of the diaphragm edge C_d and the combined mass of the coil and diaphragm $M_c + M_d$ must be correlated to resonate somewhere within the frequency

$M_d + M_c$ at the highest frequency which is to be reproduced.

The low frequency response is obtained by connecting a tube M_t from the outside of the case to the case volume C_r . In general, the low frequency range, once the diaphragm size is fixed, will be determined by the case volume and tube dimensions. If the case volume is reduced below a certain value it will not be possible to secure the desired low frequency range regardless of the tube dimensions chosen. The tube is terminated under the front screen of the microphone in order to prevent wind excitation such as might be caused by mov-

ing the microphone or talking close to it. Finally damping is introduced by closing the annular air gap with an acoustic resistance material R_r of sufficient magnitude to make Z_m substantially constant with respect to frequency. See Fig. 5.

Attention will now be given to some of the specific parts involved in the design.

Diaphragm and Coil

The diaphragm must be of a material which is low in density, easily fabricated, rugged, and stable with regard to time, temperature, and humidity. A wide choice of materials exists—metals, plastics and phenolics. Any one may be used with considerable success. Aluminum or aluminum alloys are suitable for diaphragms but are, however, open to objections from the point of ease of fabrication and ruggedness. Such diaphragms are easily deformed by careless handling. In addition they have low values of inherent damping and make the problem of damping the moving system more complex. Phenolics are objectionable because they generally absorb appreciable amounts of moisture and in so doing change shape, which results in a microphone with unstable operating characteristics. The choice is therefore centered on one of the high temperature, non-hygroscopic thermoplastic materials which had an excellent record in previous microphone designs.

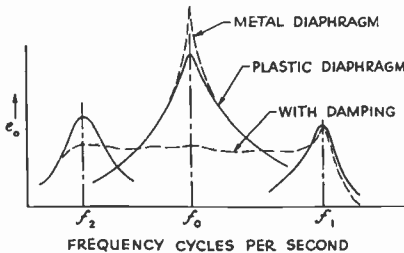

FIG. 5. Theoretical response characteristics of Type BK-1A Microphone.

range between 500 and 1000 cycles if a flat response characteristic to 50 cycles is to be attained. The space immediately behind the diaphragm must be made sufficiently small to introduce an acoustic stiffness C_v into the system which will resonate with the diaphragm and voice coil mass,

³ Elements of Acoustical Engineering, H. F. Olson, 1947. Chapter IV, pp. 67-85; Chapter VIII, pp. 226-233.

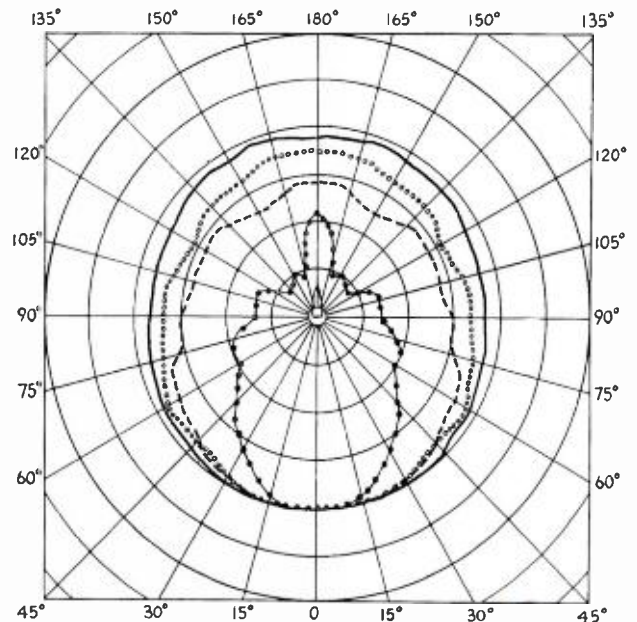

FIG. 6. Typical directional pattern of Type BK-1A Microphone.

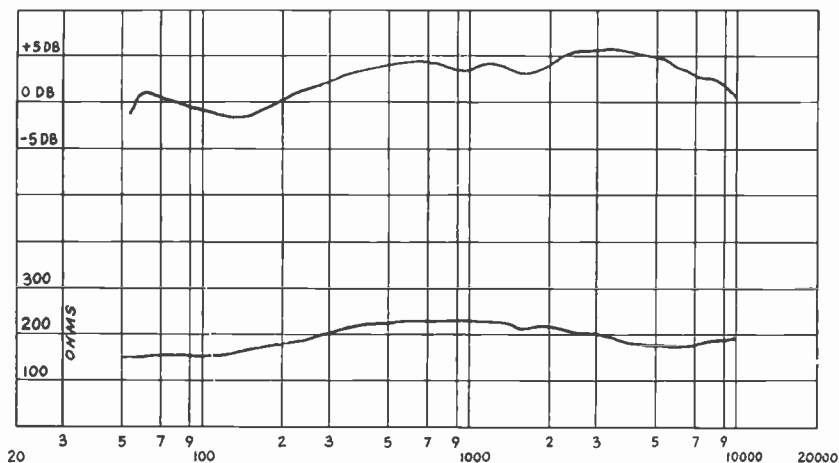

FIG. 7. Typical response and impedance characteristics of Type BK-1A Microphone.

The thickness of the diaphragm is made as small as possible consistent with ruggedness. Trouble with rocking modes of vibration at the higher frequencies will occur if the diaphragm is too thin. The amplitude of the diaphragm motion is very small, however linearity of edge stiffness and stability of position is provided either by fluting, or annular corrugations around the diaphragm edge.

The voice coil is securely cemented to the diaphragm. It is a two layer type for simplicity of manufacture and subsequent assembly. The coil conductor is of aluminum because it exhibits a superior conductivity to mass ratio as compared to copper.

Magnetic Circuit

The elementary design of the magnetic circuit and the choice of the magnet material automatically centers on Alnico V. The length of the magnet can easily be estimated from the length of the air gap in the microphone, the desired flux density, and the data supplied by the manufacturer of the magnetic material.

$$(3) l_m = \frac{B_g l_g K}{H_d} \quad (4) A_m = \frac{B_g A_g K_1}{B_d}$$

- where B_g = flux density in gap
 A_g = area of pole face
 l_g = length of airgap
 l_m = length of magnet
 A_m = area of magnet
 K = (1.3-1.4) leakage factor
 K_1 = (3-10) leakage factor
 H_d = magnetizing force in oersteds
 B_d = flux density in gauss
 (See Fig. 8)

Because of the difficulties encountered in accurately estimating the effect of leakage factors in a complex structure, the final design is evolved from the estimated design by a series of carefully controlled experimental models. The result is a structure which for the volume available for magnet produces a maximum flux density in the gap.

For structures of this general size the maximum efficiency in terms of weight, and airgap magnetic energy, is obtained by placing the magnet material in the center leg. However mechanical considerations of centering, assembly, etc., led to the decision to place the magnetic material in the form of two semi-annular slugs at the outside of the structure. This was done with a relatively small loss in the efficient use of the magnet material.

Output Transformer

It is not feasible to provide voice coil impedances of the order of 150-250 ohms so an impedance matching transformer must be provided. This transformer must be carefully designed to provide a maximum efficiency consistent with size limitations and at the same time must adequately cover the frequency range over which the microphone is to operate. Every db lost in the transformer can only be recovered at considerable expense in the transducer element.

Physically the transformer is placed inside the portion of the case which contributes to the acoustic performance of the

microphone. The terminal board is not, and opening the case in order to change impedances in no way affects the performance of the microphone. The gain in mechanical stability and simplicity of the structure is considerable as compared with some of the older designs.

As is desirable the impedance selective arrangement is not too readily available to operating personnel in order to assure that it remains proper for the established system in any given installation. Once set it is rarely changed.

Cable

The cable is of high grade and follows the proposed RTMA Standard employing a brown jacket so that the microphone cable may be readily identified among the maze of the wires that commonly cover the floor of the TV studio. This is important since the proximity of the power cables and microphone cable may result in excessive hum pickup.

Typical performance curves of a microphone of the Type BK-1A are shown in Fig. 6 and Fig. 7.

Appearance

The appearance of the microphone is of great importance in television. A satisfactory appearance was attained only through the extensive use of mock-up models and frequent consultation with a qualified functional designer.

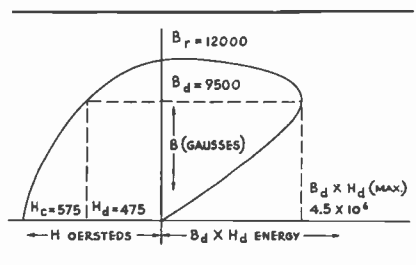

FIG. 8. Magnetization curve for Alnico V, Type BK-1A Microphone.

The microphone must not present efficient light reflecting surfaces and as a result it was necessary to develop a finish which while not light reflecting would still present a pleasing appearance. The result was a low gloss metaluster finish which has come to be called TV Gray. The foregoing approach to the problem of microphone design resulted in the Type BK-1A Microphone.

RCA BROADCAST REPRESENTATIVES ASSUME NEW POSITIONS IN FIELD



JOSEPH R. SIMS

Joe Sims will serve the Boston area as a Broadcast Field Sales Representative. After graduating from Indiana University with an A.B. in Chemistry and Physics in 1939, Joe served in the Army Air Force as pilot and radio man. After the war, he joined RCA as a Class A Engineer, then in 1947 he transferred to RCA International and was sent to the Near East.

Just previous to his newest assignment, Joe was working with the Broadcast Product Group as a sales and merchandising analyst. One of the most important projects on which he worked was the television antenna atop the Empire State Building.

ROBERT S. EMCH

Robert Emch, newly appointed Broadcast Field Sales Representative with headquarters in Cleveland, Ohio, was graduated from Penn State in 1943 majoring in Engineering and Mathematics.

Previous to his employment with RCA, "Bob" held responsible positions with not one but two separate radio stations at the same time. At both WARC, Rochester, New York and WKST, New Castle, Pennsylvania, "Bob" served as Chief Engineer and Operations Director. In these activities, he supervised technical operations as well as personnel.



J. F. INGELS

Frank Ingels, who has been assigned to the Kansas City Office, will serve Broadcasters in the midwest area.

Frank was graduated in 1929 from the University of Chicago with a degree in Electrical Engineering. After working at many diversified jobs during the thirties, he became a technician for the Sperry Gyroscope Company in 1942. In 1944, he joined the RCA Service Company of Camden and served as a Field Engineer until his recent appointment as Broadcast Field Sales Representative.

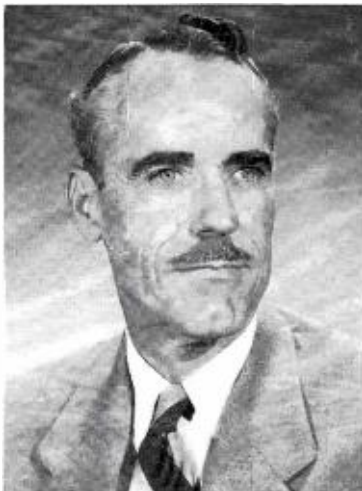



New RCA Fleetfone Station Console



Announcing...

RCA's new 2-way radio *Fleetfone* "DESK STATION"

Now . . . a 60-watt transmitter plus receiver in a single case. Saves space. Simplifies operation. Makes maintenance easier. Read how . . .

Good news for 2-way radio users! A "desk station" you can install 'most anywhere . . . on a desk, a table, or even on a shelf against the wall.

60-watt transmitter exceeds FCC and RTMA requirements

Precision controlled by RCA ovenless crystal unit, with spurious emission reduced to minimum. Two-frequency or three-frequency transmission possible. Very economical to operate. Most tubes work at less than 70%

capacity. Result: longer tube life, less maintenance. Uses standard tubes.

Receiver gives adjacent channel selectivity

Exceptionally sharp selectivity. Circuits specially designed to give clear reception from mobile transmitters, even in high-interference areas. Two-frequency reception possible by adding another frequency kit. Receiver uses only 5 tube types. Allows minimum spare-tube stock.

Console built for easy operation and servicing

Sloping front panel, easy access to controls. Built-in direct reading electric clock. Transmitter-receiver chassis

slides out at the top for ready access.

Get full details . . . mail coupon today
Find out all about this great new "desk station" that gives you full-power performance from a single package. All backed up by RCA . . . world leader in radio. Service available from RCA Service Company if desired.

FREE BOOKLET . . .

MAIL COUPON

Dept. 129, RCA Engineering Products, Camden, New Jersey

Please send me full information on your new RCA Fleetfone Station Console.

Name _____

Title _____

Company _____

Address _____

City _____ State _____

Also, please send me information on use of 2-way radio in industry checked below:

- General Industry (Utilities, Construction, Petroleum, Lumber, Mining, etc.)
- Transportation (Truck, Bus, Taxi, etc.)
- Public Safety (Police, Fire, Ranger, etc.)



RADIO CORPORATION of AMERICA

EVERYTHING FOR

1. RCA Film Camera
Type TK-20C

2. RCA 16mm Television Film
Projector Type TP-16D

3. RCA 35mm Television Film
Projector Type TP-35C

4. RCA Film Multiplexer
Type TP-9B

Film Projection Room, complete with new RCA film camera, two new film projectors, and multiplexer. Can be remote-controlled from your audio/video console.

CO-ORDINATED

FILM SYSTEMS

1. New Film Camera Type TK-20C produces clear pictures approaching the quality of studio pick-ups. Low noise level. No image "sticking." No constant shading needed. It looks equally well with the 16mm projectors, and 3" x 4" opaque slide projectors.

2. The 16mm TV Film Projector Type TP-16D makes film programming practical, economical. It's entirely self-contained. It's designed and built only by RCA.

3. The 35mm TV Film Projector TP-35C uses a highly efficient pulsed light source. The projector operates without a shutter mechanism, is completely self-enclosed (including film mechanism) . . . and it's designed and built by RCA!

4. Type TP-9B Film Multiplexer enables you to use two projectors with one film camera for maximum program flexibility.

5. TK-3A Flying Spot Camera produces high-quality video signals from 2" x 2" transparencies. Dual channel increases flexibility, provides for lap dissolve and switching between channels. Ideal for titles, spots, commercial inserts (spots), test patterns. Special Effects Amplifier TA-15A is an ideal accessory.

RCA is your headquarters for a complete line of television film equipment. If you need 16mm or 35mm television projection equipment, RCA has the finest. If you want a revolutionary film camera, RCA has it. Kinescope recording equipment, automatic slide projectors, flying spot cameras, automatic processors, and miscellaneous accessories such as rewinders, reels, slide viewers, and film cleaning equipment, also are available.

RCA equipment can be used in many different combinations to fit your

planning and budget. For example, you can start with a complete film projection setup as illustrated here. Or you can start simply with a film projector, and add facilities as your program service grows. Note this fact, too: *RCA Service Company engineers are available on a nationwide basis to keep your RCA film equipment in top condition!*

Film systems planning is another RCA television service available to you through your RCA Broadcast Sales Representative. Take advantage of his broad experience.



5. RCA Flying Spot Camera
Type TK-3A



RADIO CORPORATION of AMERICA
ENGINEERING PRODUCTS DEPARTMENT
CAMDEN, N. J.

New Pressure Microphone

TV style!



BK-1A
All-New
Pressure Microphone
AM, FM and TV

THIS IS THE NEW MICROPHONE that made broadcast and television history at the political conventions. It includes every outstanding characteristic of the RCA 88-A, which it replaces, plus new advantages found in no other microphone in its price range or class. Check the facts!

- Type BK-1A is unobtrusive, even in the "close-ups." New styling, non-reflecting finish blends right into the TV picture
- Type BK-1A is absolutely insensitive to air blast and vibration—ideal for "close-ups"
- Type BK-1A has a frequency characteristic that is independent of distance from the sound source
- Type BK-1A has uniform response over the essential audio range
- Type BK-1A can be used in any kind of weather
- Type BK-1A detaches from base for hand-announcing (it can also be mounted on floor stands)
- Type BK-1A is equipped with a ball-and-swivel mount—can be turned in any direction
- Type BK-1A is only 8 inches high; weighs just 19 oz. (less base and cable)

For details and delivery information on this new remarkable semi-directional microphone, call your RCA Broadcast Sales Representative

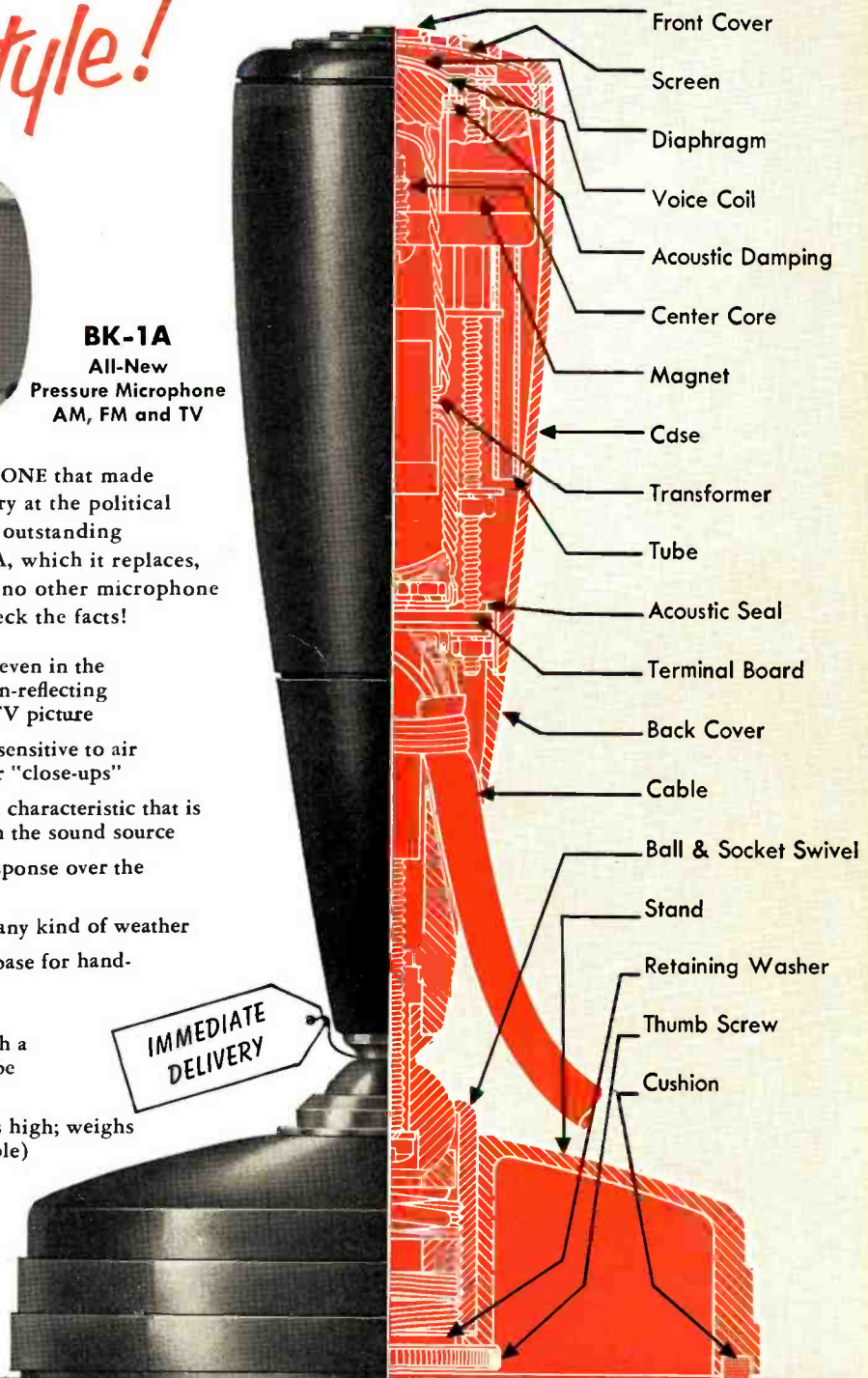

RADIO CORPORATION of AMERICA
ENGINEERING PRODUCTS DEPARTMENT
CAMDEN, N.J.