

AM · FM · TELEVISION
BROADCAST
NEWS

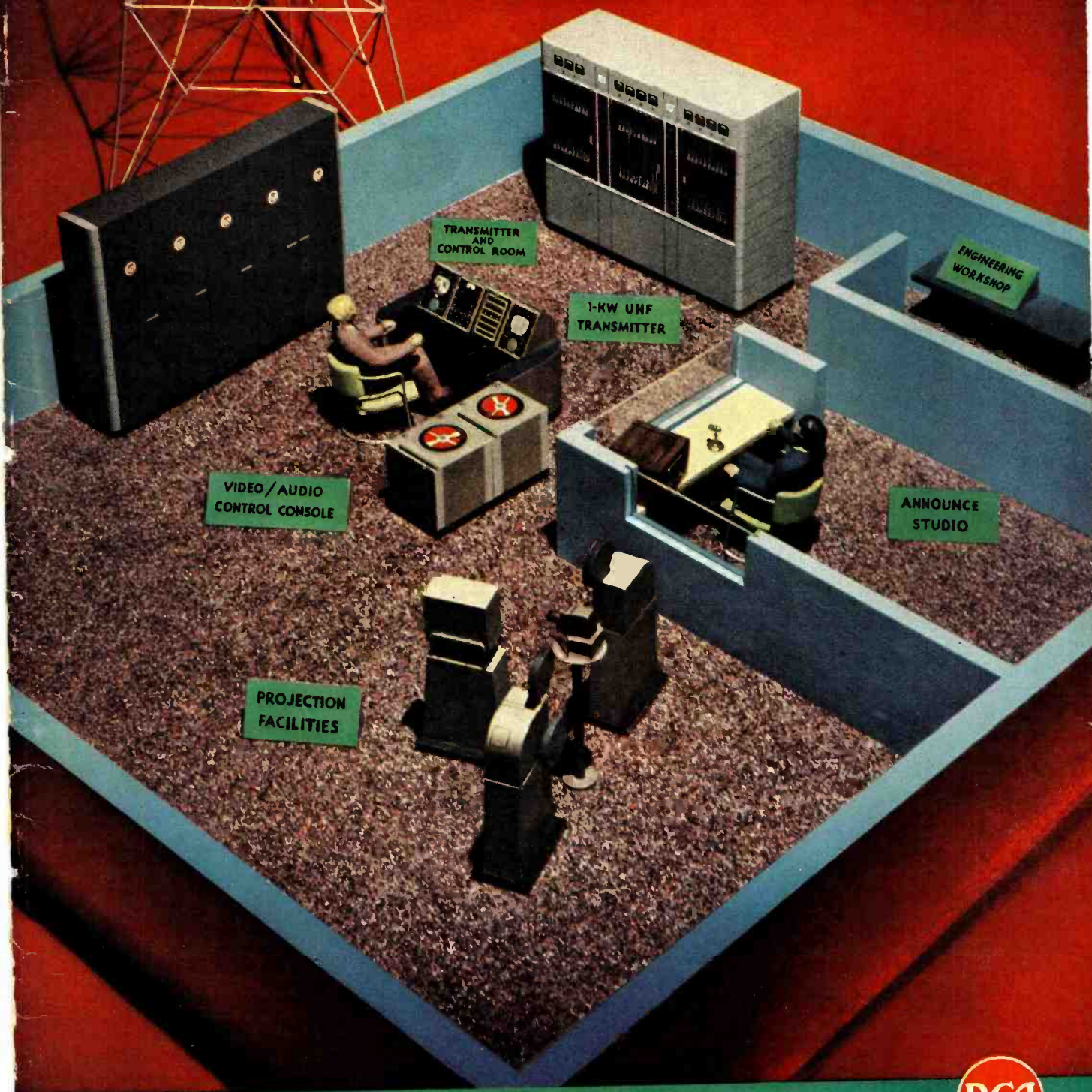

Basic Buy for UHF TV Stations . . . Pg. 8

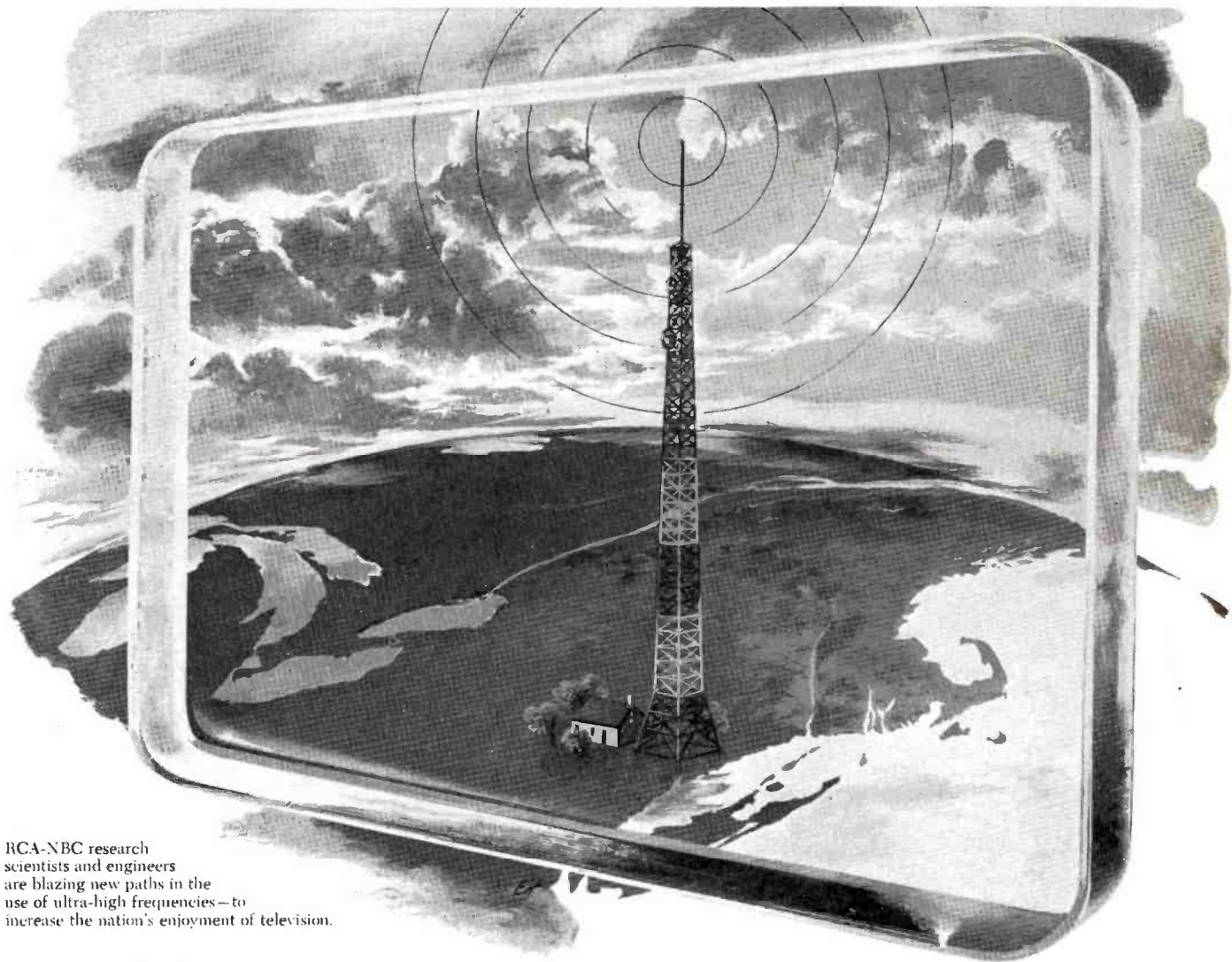



RCA-NBC research scientists and engineers are blazing new paths in the use of ultra-high frequencies—to increase the nation's enjoyment of television.

*World's first custom-built UHF station
—points the way to more TV for more people*

Although television now reaches 45 million people in more than 12 million homes, thousands of communities are still too far from existing stations to be reached by *any* programs. Moreover, under present conditions, many cities with limited program service want, but can't have, additional stations.

In preparation for the establishment of a country-wide television service, RCA has pioneered for many years in ultra-high-frequency (UHF) research to gather basic facts.

Today—an experimental station built by RCA at Bridgeport, Conn., is supplying the practical expe-

rience and engineering facts needed to design the best UHF equipment—including transmitters, receivers, and converters. NBC programs on the air during the full broadcast day are used by RCA—and other manufacturers, too—for large-scale field tests.

From results of this pioneering, RCA engineers have determined that practical UHF television equipment can be built to serve the public, and that present RCA Victor television sets can be readily adapted to give equally fine performance on both UHF and VHF.

See the latest in radio, television, and electronics at RCA Exhibition Hall, 36 West 49th Street, N. Y. Admission is free. Radio Corporation of America, RCA Building, Radio City, New York 20, N. Y.

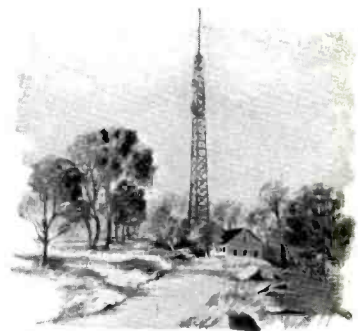

Built by RCA at Bridgeport, Conn.—the first UHF transmitter to operate on a regular schedule.



RADIO CORPORATION of AMERICA

World Leader in Radio — First in Television

Broadcast News

AM • FM • TELEVISION

Published by the

RADIO CORPORATION OF AMERICA

ENGINEERING PRODUCTS DEPARTMENT . . . CAMDEN, NEW JERSEY

NUMBER 66

SEPTEMBER-OCTOBER, 1951

Subscription Rates

In continental U. S. A. - \$4.00 for 12 issues

In other countries . . . \$5.00 for 12 issues

JOHN P. TAYLOR, Editor

W. O. HADLOCK, Managing Editor

M. L. GASKILL, E. B. MAY, E. C. MASON, W. R. COULTER, Associate Editors

Contents

BROADCAST AUDIO WIRING PRACTICE	by W. E. STEWART	6
THE RCA "BASIC BUY" EQUIPMENT LAYOUT		
	by L. E. ANDERSON AND W. O. HADLOCK	8
WFIL GOES "45"	by LOUIS E. LITTLEJOHN	16
TELEVISION MICROPHONE TECHNIQUES	by WHITNEY M. BASTON	18
KOTA AND KOZY, RAPID CITY, SOUTH DAKOTA	by A. E. GRIFFITHS	24
NEW 3/8-INCH UHF ULTRA LOW LOSS COAXIAL LINE	by O. O. FIET	30
THE "EIGHTH" BROADCASTERS' TV TRAINING PROGRAM		
	by E. C. MASON AND W. R. COULTER	36
U. S. ARMY SIGNAL CORPS NOW HAS "ELECTRONIC EYES"		40
NEW 5 KW AM TRANSMITTER	by M. H. HUTT	48
HAM FORUM	by M. L. GASKILL	56

Copyright 1951
Radio Corporation of America
RCA Victor Division
Camden, N. J.

PRINTED
IN
U.S.A.

THE COVER of this issue shows the "Basic Buy" TV Equipment which is described in the article beginning on Pg. 8. The illustration is reproduced from a Kodachrome of a model station layout which was put together specifically for the purpose of studying the best arrangement of facilities for a small TV station. The models of the individual equipment items were made by using the cardboard cutouts available in our model books (see BROADCAST NEWS No. 52).

In order to make the cutouts more rigid—and more wear-resistant—they were assembled on wooden blocks which had been precut to proper size. In other words, you first cut a block of wood to proper size and shape. Then you glue the front, sides and back of the cutout to the block. A coat of varnish over the whole thing, and you have an accurately scaled model with the appearance of the real thing. If you are going to shuffle your models around a lot this little extra work is worthwhile. Moreover, this gives you finished models suitable for exhibit in a show window or the boss' office. However, it takes a bit of head-scratching to figure the right size for the blocks . . . don't say we didn't warn you.

HOW BASIC is the "Basic Buy"? The answer is that it is just about the minimum equipment you can start with—from a practical viewpoint. You will hear lower-priced packages quoted, of course. But when you make comparisons be sure you are comparing the same total number of units—and of facilities. There can be differences! For instance, you obviously must have a transmitter, an antenna and the FCC-prescribed monitoring equipment. Probably any list you look at will include these. But how about film equipment? In theory, you don't absolutely have to have it. But if you don't, you won't be able to run any local programs (no slides, even) and, horror of horrors, no Westerns! In practice, you can't eat without film equipment—so we've included it as basic.

Similarly, with the control console. You can live without it—and some "minimum" lists omit a console. But we feel you need it. It makes for more convenient operation, saves wear and tear on operators, and permits one operator to run "the works" during many periods. Thus it really saves money, for any experienced owner knows that, in the long run, equipment is cheaper than manpower.

The console and the film equipment are the biggest items on our "basic" list which may not be on all such lists. But there are other items, too. Thus we suggest (in fact, plead with you) that you carefully check the itemized list on Pg. 14 with any other "minimum" list you consider. "Do it today!"

BASIC DECISION you must make when you buy your first TV equipment is not *what* equipment, but *whose* equipment to buy. Sooner or later (probably sooner) you will be ordering more equipment, in any event. If you start right (no matter with what number of units) you can always add on. But if you start wrong—brother, it's a mess. Some manufacturers advertise that their equipment will work with any other equipment. But any experienced broadcast engineer knows that it pays to stick to one make. Units which were originally designed to work together are much more likely to do so. Service is simplified, matching appearance is achieved, etc. In a new field, such as TV—where such things as signal levels and input and output impedances are not yet fully standardized—the advantages of using "matching" units are obvious. The only sure way is to use equipment of one manufacturer. And who should that be? Well, it certainly should be the equipment of a manufacturer who makes *everything*, and who stocks and catalogs in the way you are accustomed to. We only know of one such company. Need we say more!

For UHF

...go **RCA**

Any power to 200 kw*....

10-kw UHF Transmitter Type TTU-10A

RCA's answer to high power on channels 14 to 83. With an RCA high-gain UHF antenna, this transmitter can produce up to 200 kw, ERP. One standard, easy-to-handle tube type is used in all power stages!

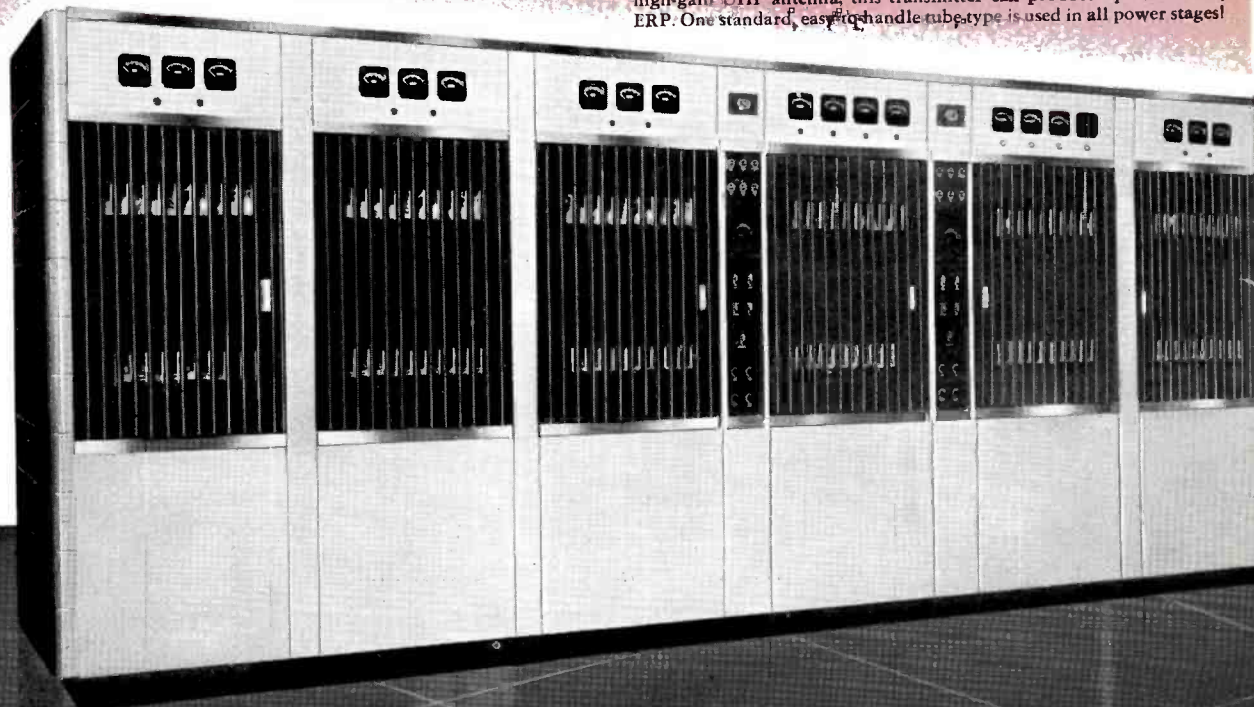

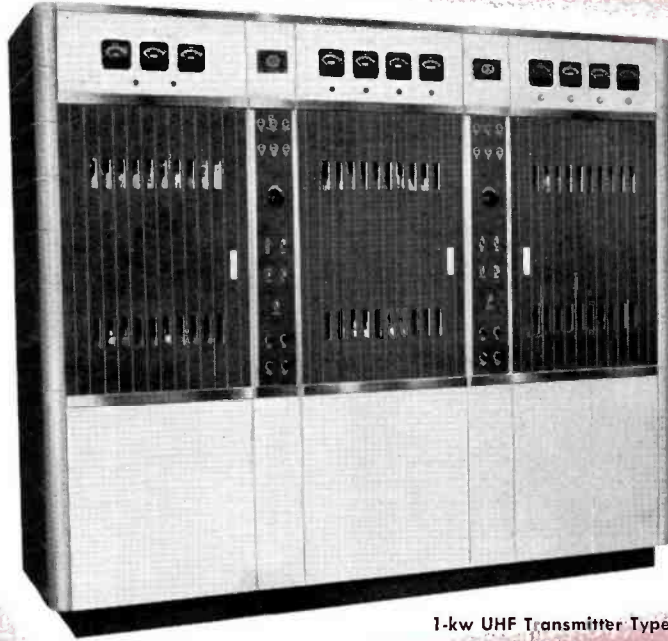

1-kw UHF Transmitter Type TTU-1B

This transmitter, and a high-gain RCA UHF antenna, can produce up to 20 kw, ERP on channels 14 to 83! Type TTU-1B is all air-cooled.

RCA's new 1-kw and 10-kw UHF transmitters (and RCA's high-gain UHF antennas) will give you power combinations up to 200 kw . . . on any TV channel!

If you are planning high power UHF, RCA's new 10-kw transmitter is the answer. If you are planning to start with low power UHF, then RCA's new 1-kw transmitter will meet your needs (increase power later simply by adding matching amplifier units).

Be sure your station planning is correct from the start . . . before you invest a single dollar. Your RCA Broadcast Sales Specialist will show you exactly what equipment you'll need to get on the air at lowest cost.

Available only from your RCA Broadcast Sales Specialist

A 64-page book on RCA's new line of TV broadcast equipment for all channels, 2 to 83! An indispensable reference for station planning.



Call or write the RCA field office nearest you

Chicago 11, Ill.
666 North Lake Shore Drive
Telephone: Delaware 7-0700

Washington 6, D. C.
1625 K Street, N. W.
Telephone: District 1260

Hollywood 28, Calif.
1560 N. Vine Street
Telephone: Hollywood 9-2154

Dallas 1, Texas
1907-11 McKinney Ave.
Telephone: R-1371, 1372, 1373

Cleveland 15, Ohio
718 Kelth Building
Telephone: Cherry 1-3450

Atlanta 3, Ga.
522-533 Forsyth Bldg.
Forsyth and Luckie Sts.
Telephone: Walnut 5946

Kansas City 8, Mo.
221 W. 18th Street
Telephone: Victor 6410

New York 20, N. Y.
36 W. 49th Street
Telephone: Circle 6-4030

San Francisco 3, Calif.
1355 Market Street
Telephone: Hemlock 1-8300

New High-Gain Antenna for UHF

The most economical way known to produce high effective radiated power for UHF—and more kilowatts per dollar. Excellent "close-in" coverage in all directions. Power gain, 24 to 28, depending on channel.



*Effective Radiated Power



RADIO CORPORATION of AMERICA
ENGINEERING PRODUCTS DEPARTMENT
CAMDEN, N. J.

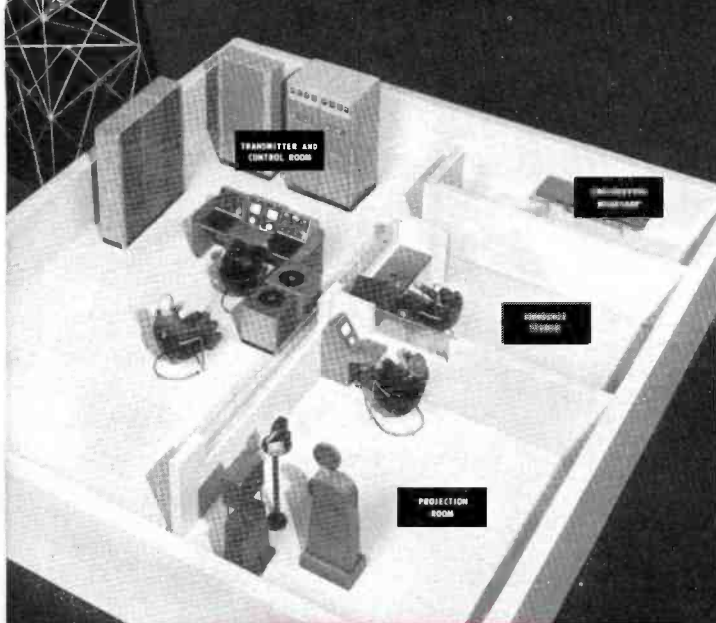

500 watts VHF (ERP range, 1/2 to 2 kw) This is a control-room set-up—complete with an RCA 500-watt transmitter, announce booth, and film facilities. The arrangement, and an RCA 5-bay Super Turnstile Antenna, provides up to 2 kw ERP*—gets you on the air for minimum outlay.

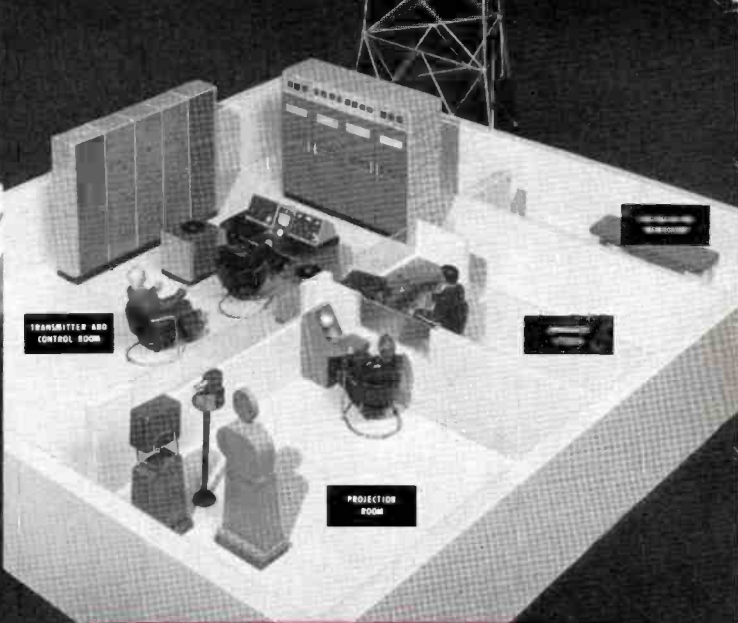

2 kw VHF (ERP range, 2 to 20 kw) Similar to 500-watt plant, but uses an RCA 2-kw transmitter. The ideal set-up for getting up to 20 kw (ERP) for a small investment. "In line" racks at left of control console are: monitoring, audio, and video equipments, sync generator, and power supplies.

"Tailored" transmitter plants

50 kw VHF (ERP range, 50 to 200 kw) Block "U" set-up for RCA's "50-kw." This arrangement is well suited for local building situations—or where physical limitations call for an antenna of medium gain and high ERP. Note film camera control and preview monitor next to operator for his convenience.

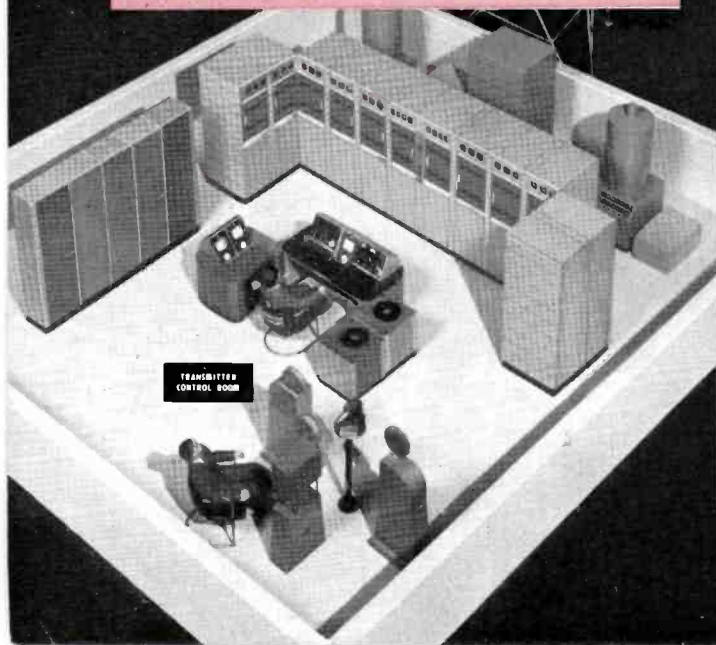

1 kw UHF (ERP range, 1 to 20 kw) For areas where UHF channels will be assigned, the "1 kw" and UHF antenna make it practical to start with a minimum investment. It offers interesting possibilities for areas up to 150,000 people—could prove popular in communities up to 1 million. Note network, film projection spots, station break facilities.

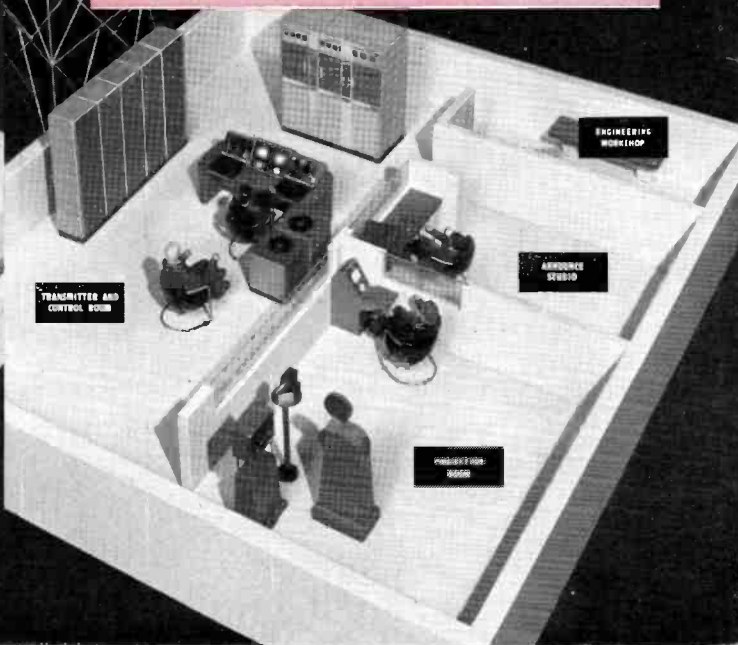

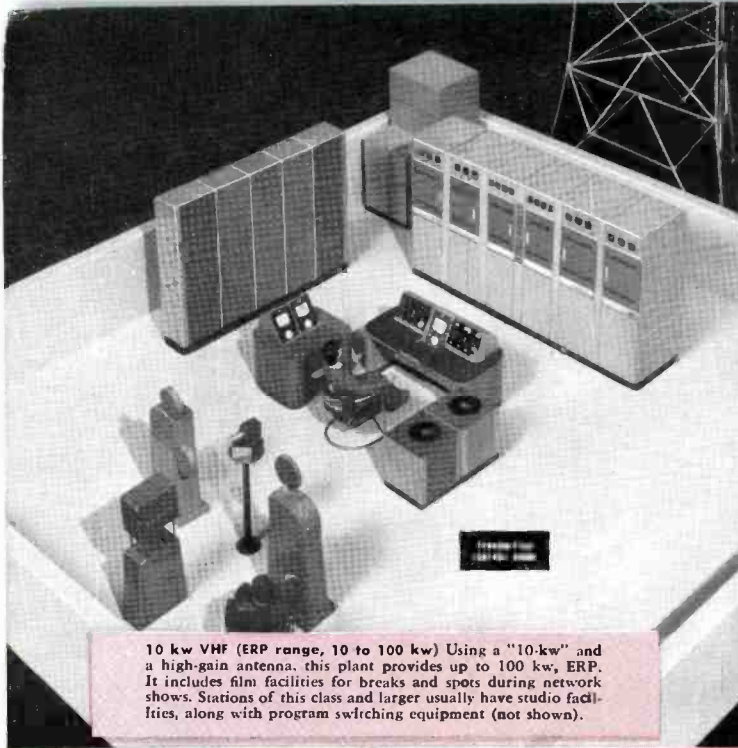

10 kw VHF (ERP range, 10 to 100 kw) Using a "10-kw" and a high-gain antenna, this plant provides up to 100 kw, ERP. It includes film facilities for breaks and spots during network shows. Stations of this class and larger usually have studio facilities, along with program switching equipment (not shown).

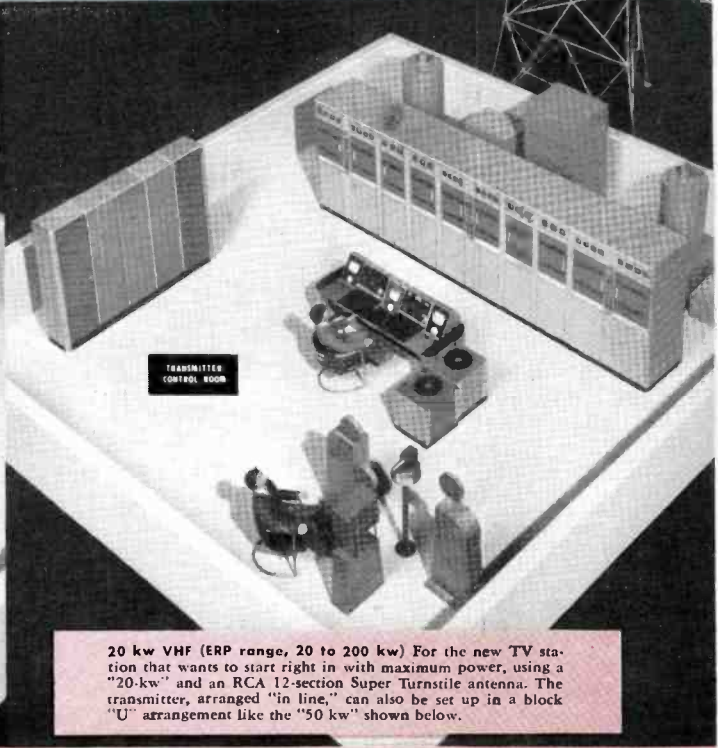

20 kw VHF (ERP range, 20 to 200 kw) For the new TV station that wants to start right in with maximum power, using a "20-kw" and an RCA 12-section Super Turnstile antenna. The transmitter, arranged "in line," can also be set up in a block "U" arrangement like the "50 kw" shown below.

... for any TV power up to

200kw!

10-kw UHF (ERP range, 10 to 200 kw) Using an RCA "10-kw UHF" type TTU-10A and a TFU-24B high-gain antenna, this set-up offers the next logical step above the "1-kw" range. Or, you can start with 1 kw now—and increase power later simply by adding RCA matching amplifiers and associated equipment.

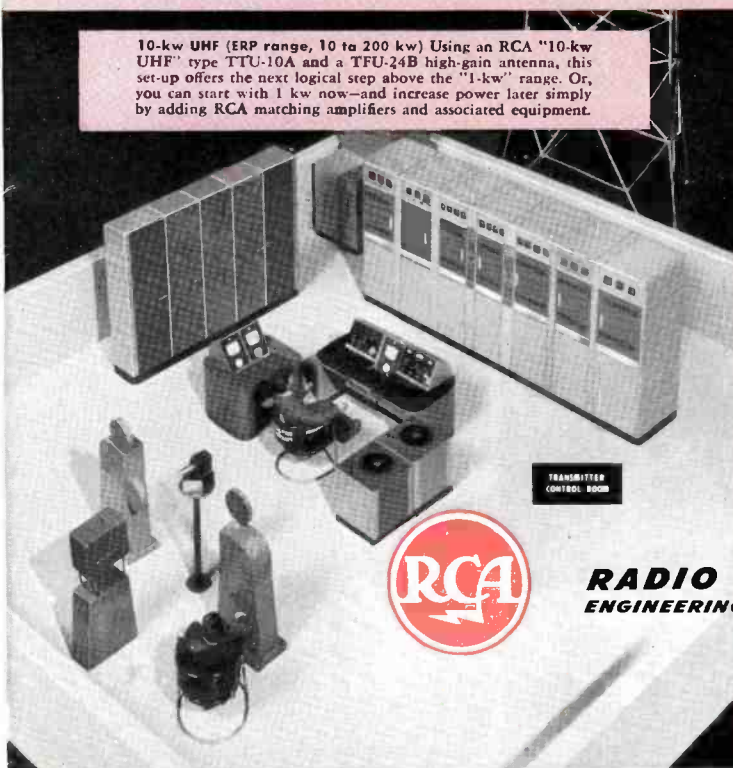

These models represent seven typical TV transmitter room arrangements for various power classes—from 500 watts to 200 kw, ERP*. They include the film equipment required for spot, station breaks, and network operation. They show the basic or minimum facilities you need to go "on the air" for a given power. The set-ups are worked out in accordance with tried-and-proved operating procedure and provide a handy means for estimating your space requirements. There is ample leeway to meet the particular needs of every station.

Your RCA Broadcast Sales Representative is ready to give you planning help like this—throughout your station! By all means, call him.

*Effective radiated power



RADIO CORPORATION of AMERICA
ENGINEERING PRODUCTS DEPARTMENT
CAMDEN, N. J.

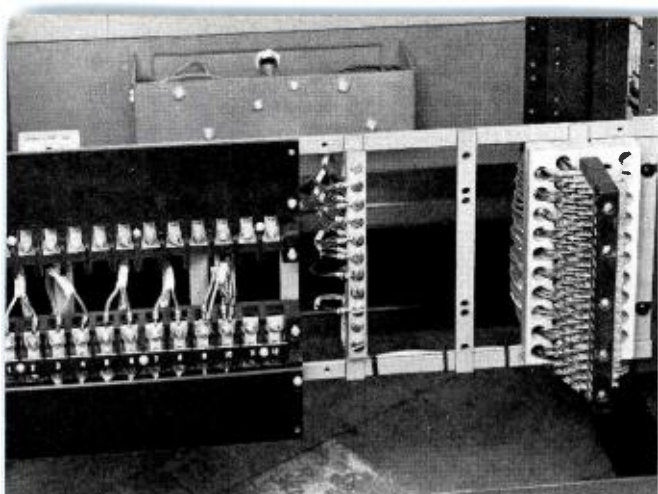

FIG. 1. Photo of terminals at bottom of rack. Power terminals are at left, ground buss in center and audio terminals at right.

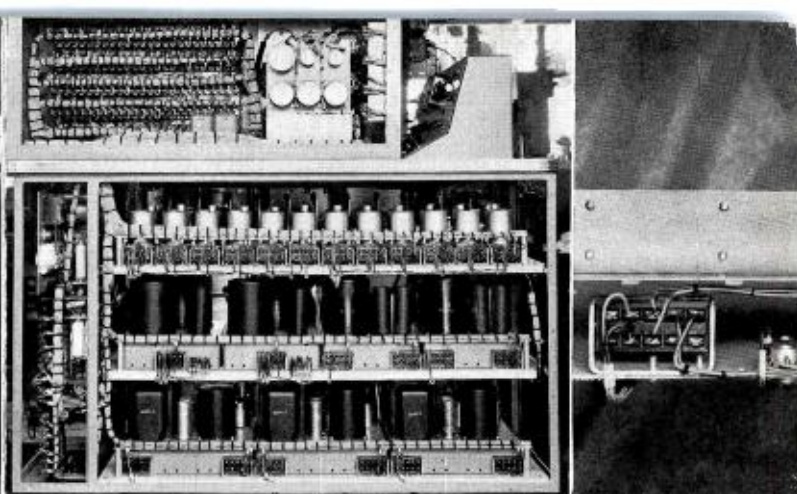

FIG. 2. View of wiring in a control desk. A-c circuits are below the shelves, and audio above.

BROADCAST AUDIO WIRING PRACTICE

W. E. STEWART, Mgr.

Broadcast Audio Engineering Section

Almost every studio installation undergoes minor modifications from time to time, and the subject of proper installation practice is raised. Modern standards require careful elimination of noise and crosstalk from the program circuits. It is not uncommon to spend many hours wiring in new components, only to find their performance reduced by the wiring itself. A tested and proven standard practice can avoid much wasted time.

There are two basic philosophies employed in practical approaches to the noise problem. In one system every circuit shield is carefully isolated from its neighbors and grounded at one point only. In the other, all the shields of one unit (such as a rack) are put in such close contact that a brute-force ground is provided for any stray currents that might be present. This latter approach is taken in RCA equipment with modifications as follows:

Every rack, cabinet or desk is wired as a unit to terminal boards. The terminal boards are placed as near as possible, consistent with accessibility, to the point where the external circuits enter the unit. See Figs. 1, 2 and 3 for examples.

In a rack, as viewed from the back, all audio cables are run on the right side of the rack; and all signal, a-c and d-c power cables are run on the left side. All audio circuits are twisted pair conductors shielded with a tinned copper braid. Separate cables are formed for:

- (a) Microphone outputs, preamplifier outputs and other audio circuits with levels below -20 VU.
- (b) Mixer, line and channel circuits up to $+30$ VU.
- (c) Loudspeaker and other lines above $+30$ VU.

- (d) At times further subdivisions are made for convenience in bulk or because levels are widely separated.

Each cable is bound with lacing cord so the shields are in tight contact for their entire length. Where two audio cables cross or join, they should either be definitely insulated or bound together. It is better to have tight contact than to risk an intermittent noise source made by casual contact.

The ends of the individual shields are terminated either with "wedge-on" collars or with plastic tape. The shields are grounded to a main ground bus near the terminal block. A shielded ground lead is run from each amplifier chassis to the ground bus.

The a-c and d-c power circuits are handled similarly. All a-c circuits should be in twisted pair, shielded cable. The a-c current should be balanced in each pair. That is, one pair should not be used for one side of a circuit and a second pair for the other side. If more than one pair is needed for the load, two or more pairs should be used with part of the load on each.

Plus and minus plate potentials should be carried in single conductor shielded cable. Shields are tied off and grounded the same as the audio circuits.

Signal circuits do not require shielded wire.

The frames of jacks should be tied together and grounded with a shielded wire the same as amplifier chassis.

In installing the equipment in a studio or control room the following rules have been found useful:

The pairs run in conduits should be grouped in the same general way as the cables in the racks. The audio conduits should be kept free from grounds to power conduits or power circuits. Low level audio circuits (less than -30 VU) should have the shields insulated from the conduits and from each other. Splices should be avoided. Low level conduits should be well spaced from power conduits.

Signal and telephone circuits should not be run in the same conduit with program or power circuits. Telephone leads should be twisted pair. Power and audio grounds should consist of separate, heavy shielded leads to the main station ground.

TV circuits in general should be considered high level circuits and should therefore be kept away from low level audio circuits. In particular, pulsed lamp circuits should be routed as far away from projector photocell and preamplifier circuits as possible. Shields should be insulated from ground and the audio circuit and shield grounded only at the point of lowest level.

Typical good practice for microphones is shown in Fig. No. 4a. In this case two conductor shielded wire, with insulation over the shield, is used for the conduit run and the microphone cord. Fig. No. 4b shows somewhat better practice in which 3-conductor shielded, insulated cable is used for the conduit run and microphone cord. This latter practice removes any ground current from the shield.

Turntable pickup circuits should be handled like microphones with particular

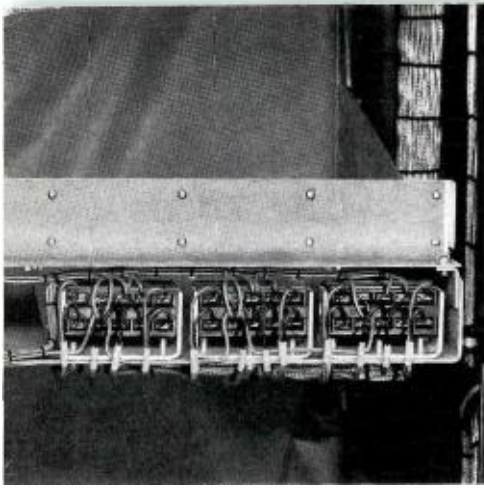

FIG. 3. Typical plug-in shelf wiring. Cover will be turned down to protect wiring after circuits are checked.

care being taken to keep the motor power circuits and their shields away from the audio circuits.

The input to mixer circuits is usually at comparatively high level, but the output is frequently very close to microphone level and the circuits should be treated in the same way. Fig. No. 5 shows typical good grounding practice in this respect. Unbalanced circuits may be used but are usually more difficult to handle if there is noise present. It will be noted that the only ground to this part of the system is at the point of lowest level and that all the circuits are balanced to ground. The center taps of the mixer attenuators are only tied to ground if special noise difficulty is encountered and tests indicate improvement. This occasionally happens on circuits which connect to remote lines or studio equipment with separate ground systems.

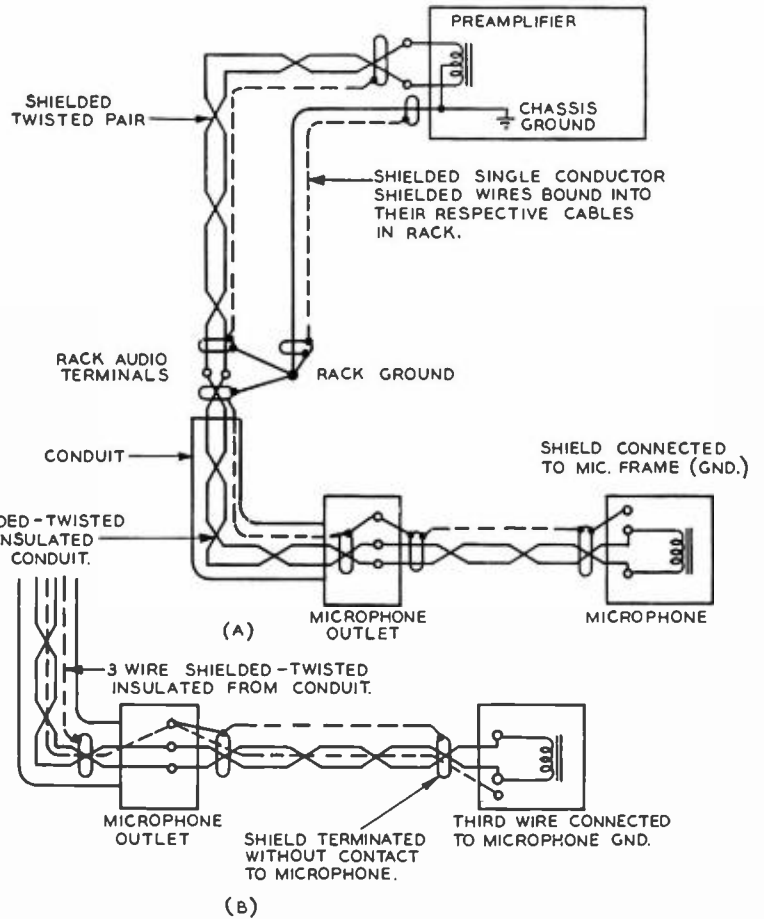

FIG. 4. Sketch showing typical microphone grounding practices.

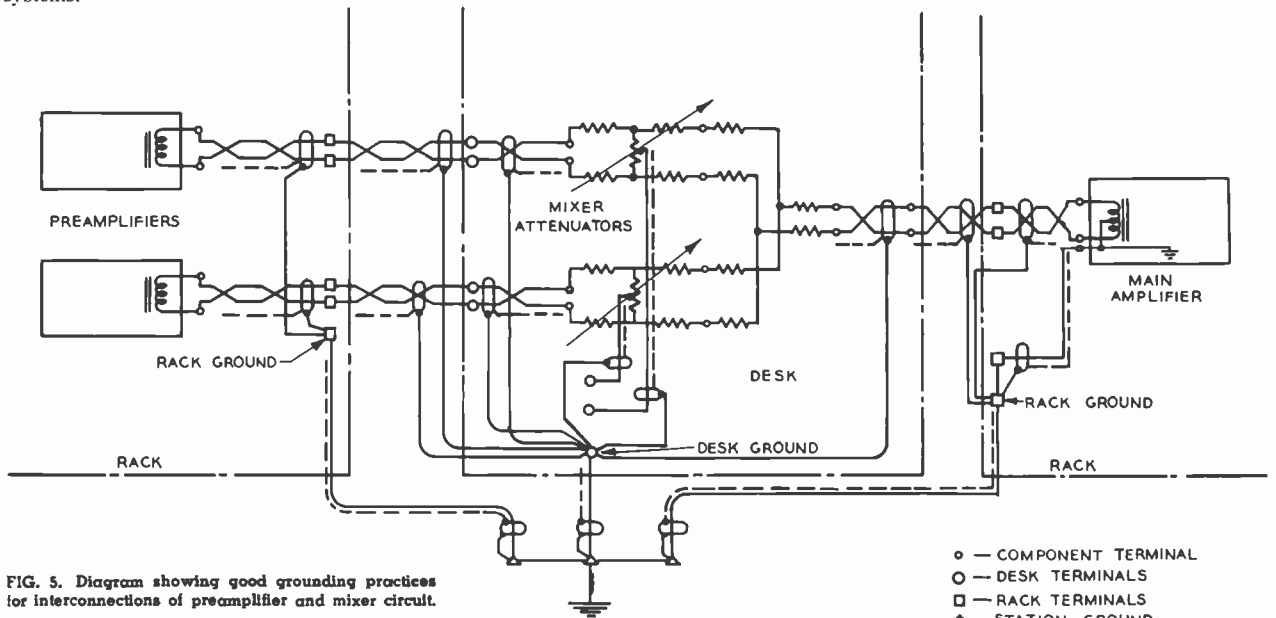

FIG. 5. Diagram showing good grounding practices for interconnections of preamplifier and mixer circuit.

- — COMPONENT TERMINAL
- — DESK TERMINALS
- — RACK TERMINALS
- ▲ — STATION GROUND

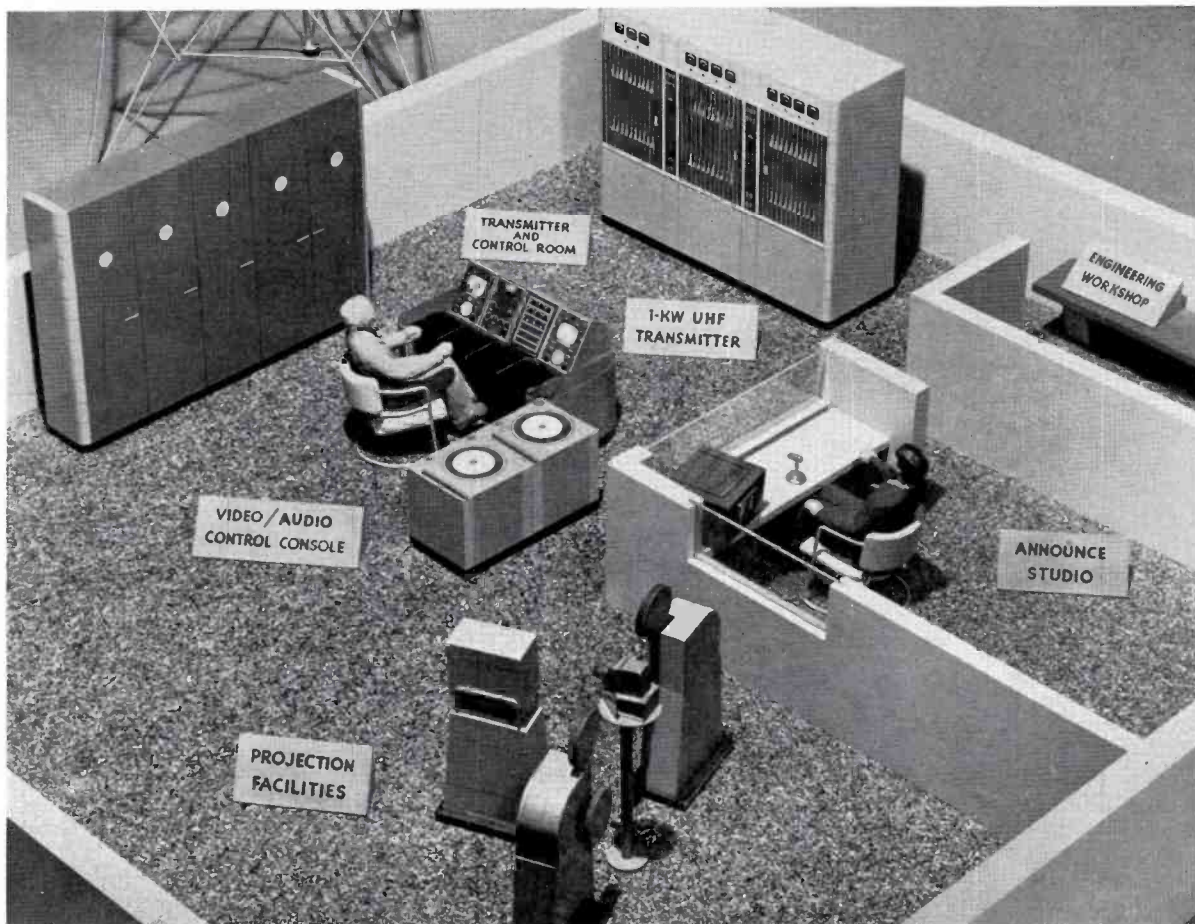

FIG. 1. Model layout of a "Basic Buy" station employing a 1 KW UHF transmitter. With the film facilities and announce booth provided, network, film, slides, spots and remotes are possible.

THE RCA "BASIC BUY" EQUIPMENT LAYOUT

For Stations Planning to Start Operation Without Live Talent Studios

by
**L. E. ANDERSON and
 W. O. HADLOCK**
 Engineering Products Department

Many broadcasters are planning television program operations which can be handled with a minimum investment in equipment and technical manpower. Of course, the simplest and most inexpensive type of television station to equip would be one that plans to use network programs entirely. However, in such a station there would be no means for presenting essential local advertising material. A more practical station is one which can present local film programs interspersed with network, or one using film alone (dependent upon the station's location with respect to network facilities).

The "Basic Buy"—What It Does

To provide adequate programming facilities for this type of operation, RCA has

designed and produced a fundamental equipment package which is well named the "Basic Buy".

With the minimum equipment supplied in the "Basic Buy", four different types of programs may be broadcast, as listed below:

- (1) Network programs.
- (2) Local film program from 16mm projectors.
- (3) Local slide projection programs.

- (4) Test pattern from monoscope.

The advertising or commercial function can be of local or network origin.

The "Basic Buy" Equipment Package

The equipment "package" required to perform the above programming operations consists essentially of an RCA type TK-20 film camera chain, TM-5A Master Monitor, two TP-16 16mm film projectors, a slide projector, multiplexer, TK-1B monoscope camera, TG-1A studio synchronizing generator, TC-4A audio-video switching console, two stabilizing amplifiers, two turntables, microphones, transmitter, antenna, audio equipment, and miscellaneous accessories such as power

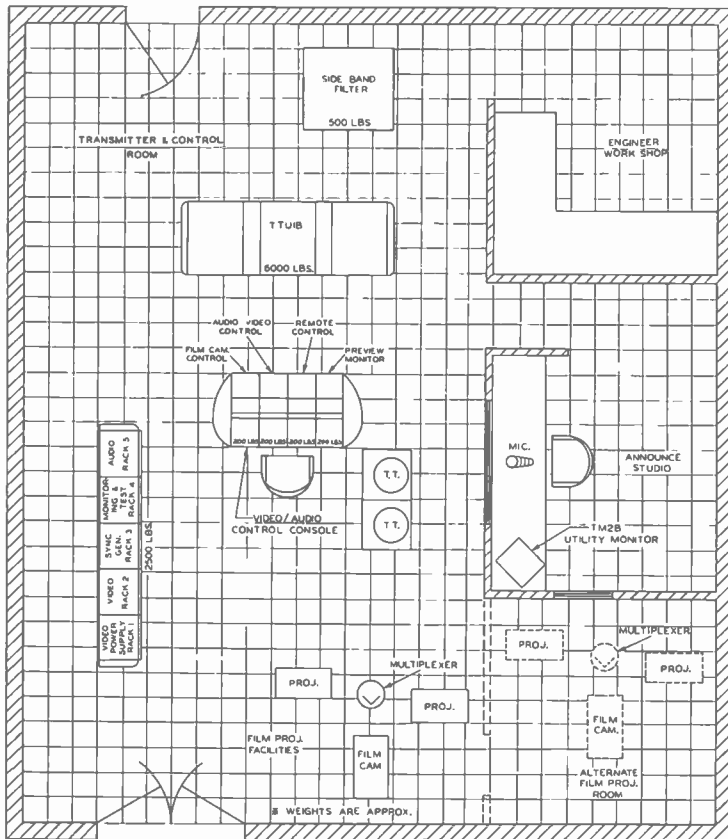

supplies. The block diagram of Figs. 3 and 6 plus the layout photos and floor plans illustrate the major equipments incorporated in the "Basic Buy".

The transmitter furnished in the "Basic Buy" package will, of course, depend upon the individual station's power and frequency requirements (UHF or VHF). All other equipment items in the package with the possible exception of antenna and transmission line remain the same for any TV station, regardless of power.

Station Layouts

The building or "plant" space required to accommodate the "Basic Buy" station equipment will vary with such factors as:

- (1) The size and power of the transmitter,
- (2) The particular arrangement of individual units,
- (3) The space or clearance planned between equipment units,
- (4) The number of rooms desired,
- (5) Plans for future expansion.

FIG. 2. Floor plan (in one-foot squares) for the 1 KW UHF station showing the approximate size and location of major components in a total area of about 900 square feet.

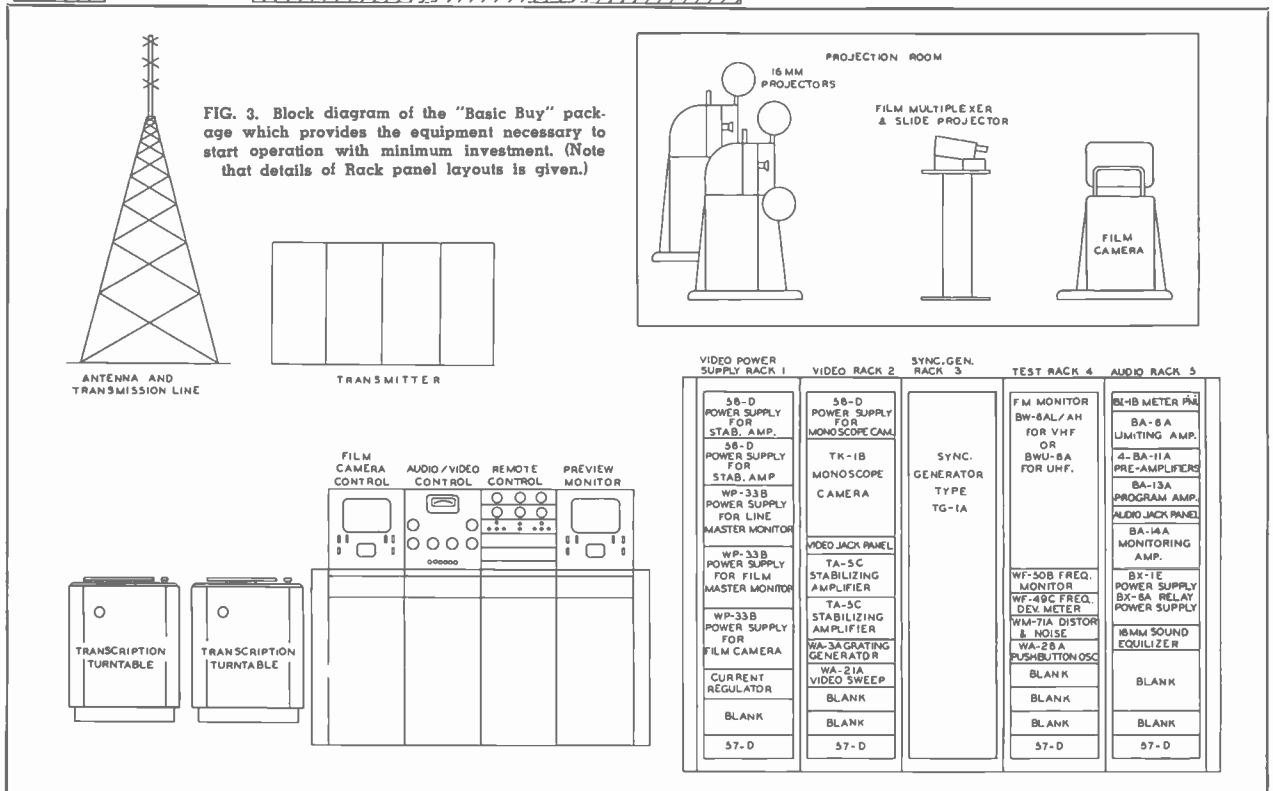

Because of these variables in planning, considerable difference in TV station arrangement is expected, ranging from very compact to roomy layouts.

Two possible layouts for the "Basic Buy" equipment are illustrated on these pages with photos and floor plans. They indicate the approximate "building" space to house the equipment needed to get "on-the-air". In each layout, the major location of the following components is illustrated.

1. Transmitter, including vestigial side-band filter, antenna diplexer and dummy load.
2. Rack equipment consisting of:
 - (a) Sound and visual frequency and modulation monitors as required by FCC.

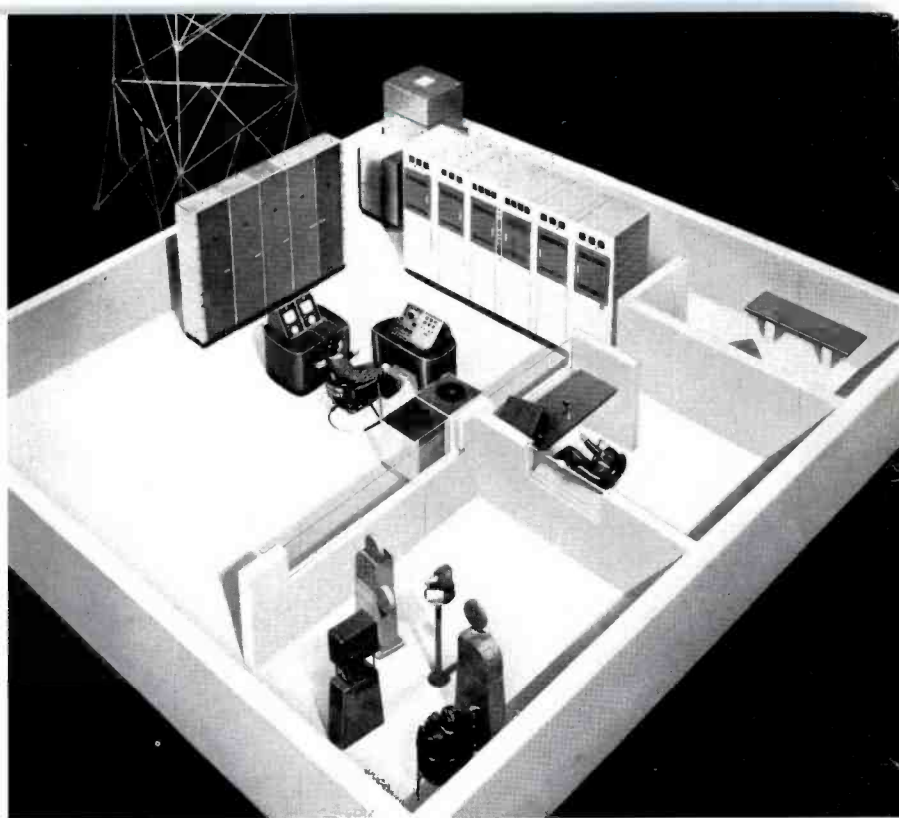
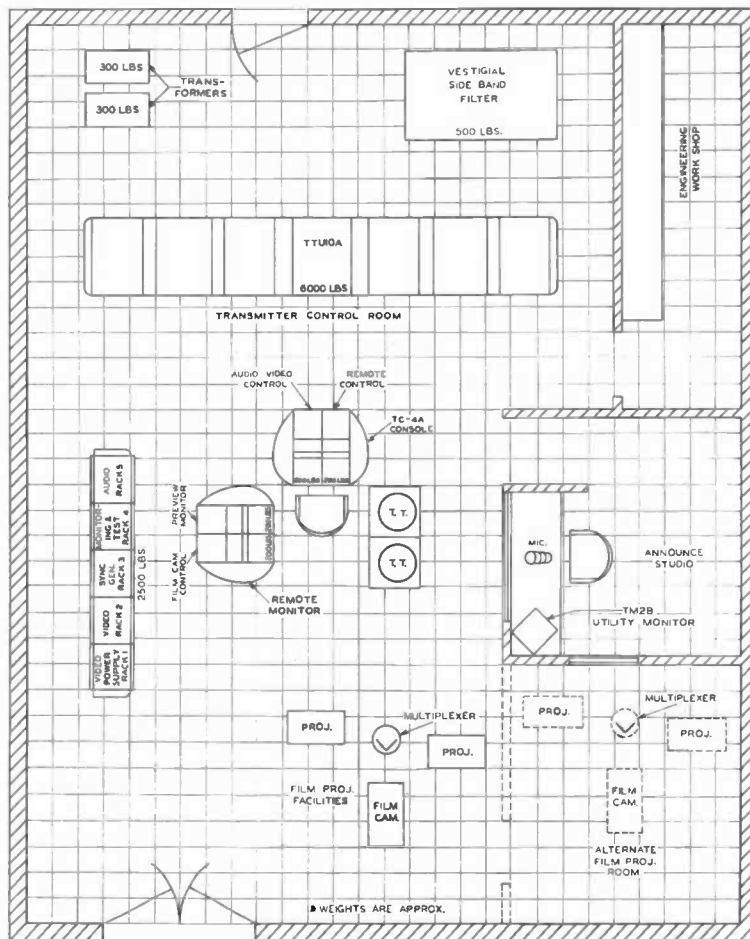

FIG. 4. Model layout of a 10 KW "Basic Buy" station (UHF or VHF). In this set-up, the Console is separated to form a "U" arrangement—with monitors at left and the TC-4A sections in center, and turntables at right.



- (b) Synchronizing generator.
 - (c) DC power supplies for operation of video amplifiers, master monitors, etc.
 - (d) Audio input equipment such as pre-amplifiers, limiting and monitoring amplifiers.
 - (e) Video input equipment such as stabilizing amplifiers, video jacks, monoscope camera and test equipment.
3. Audio-Video control desk. This desk is designed to handle the switching and fading of six video signals and their corresponding audio counterparts. It is arranged so that the transmitter operator may do most or all program switching from this point, including start and stop of film projectors. Only one other man is required to thread the projectors and operate the shading controls while the film is being run.

1 KW (UHF) Layout

A model layout and companion floor plan of a "Basic Buy" station employing a 1 KW UHF transmitter is shown in Figs. 1 and 2. For cities where UHF channels are available, this arrangement with the RCA UHF antenna provides powers up to 20 KW ERP.

FIG. 5. Floor plan of the 10 KW UHF layout showing alternate "U" console arrangement and location of components. All equipment is located in a space of approximately 1100 square feet. (Each square represents approximately one foot.)

FIG. 6. Simplified schematic diagram showing operation and system arrangement of the "Basic Buy" equipment.

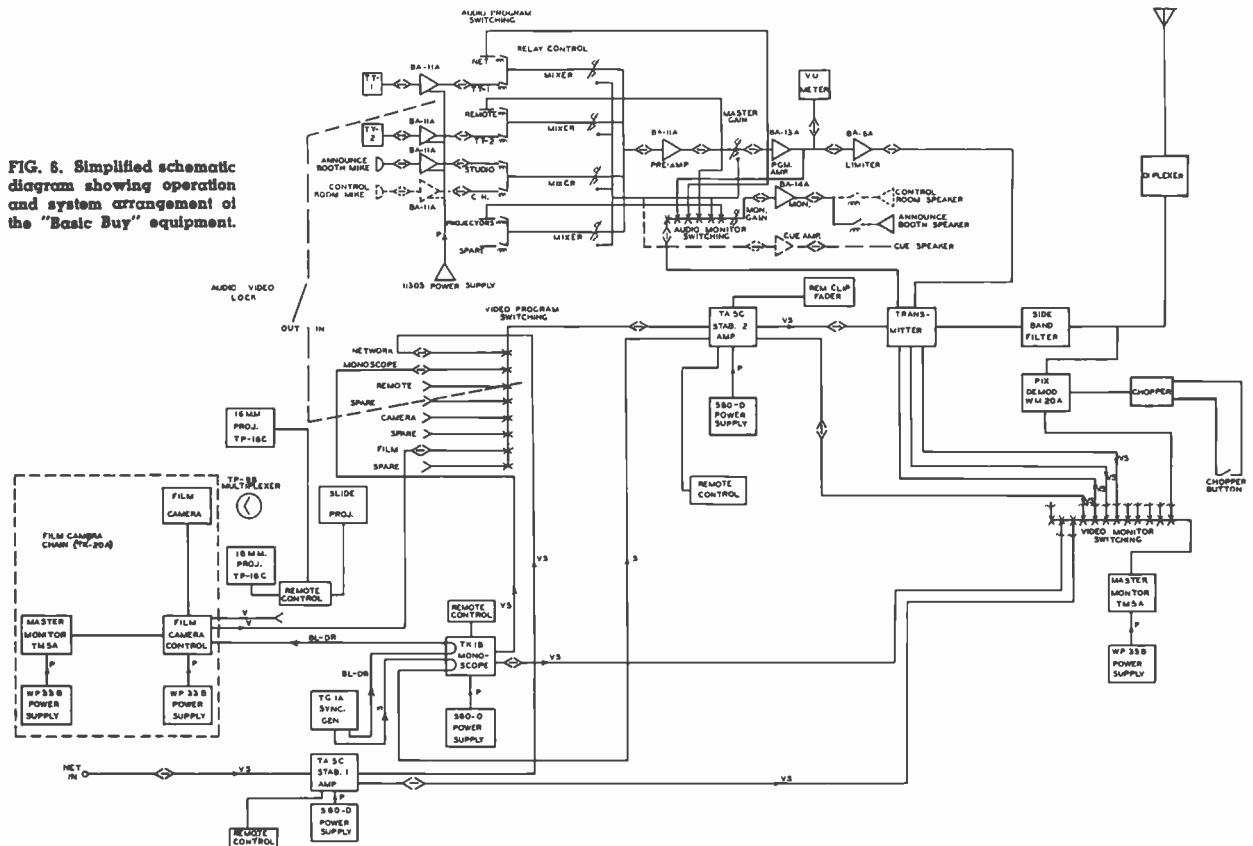

This compact, yet workable arrangement of equipment occupies a space of only 900 square feet (see Fig. 2) and provides network, film, spot and station break facilities. In this particular arrangement, the "in-line" control console is centrally located in front of the transmitter, with equipment racks at left, turntables, and announce studio at right—and film facilities at the rear. Many broadcasters may prefer to enclose the film projectors, multiplexer and film camera in a separate room. This can be done without increasing the space requirements and is recommended from an operational standpoint.

Broadcasters planning to increase UHF power at a later date with RCA 10 KW "add-on" amplifiers should plan to allow more space—or decrease the size of the announce studio and engineering workshop shown in Fig. 2. Another possible arrangement would be to locate the announce booth in one corner of the film room if a single combination room is desired. The announce booth is equipped with a TM-2B utility monitor and located (see Fig. 1) so that "visual cue" can be given from the control console position.

10 KW Layout, UHF or VHF

The model layout and floor plan of Figs. 4 and 5 are somewhat similar to those of the 1 KW UHF layout. The major difference, of course, is in the use of the 10 KW transmitter and associated components which result in a slightly larger room. The photo of Fig. 4 shows the use of an RCA 10 KW VHF transmitter. However, the over-all layout size is equally suitable for accommodating the RCA 10 KW UHF transmitter which is approximately 30 inches longer. This can be accomplished, as shown in the floor plan of Fig. 5, by use of a slightly different arrangement for the Engineering Workshop.

In either case, all items in this layout are accommodated in an over-all space of approximately 1100 square feet. The side-band filter and diplexer can be located directly behind the transmitter as shown in the floor plan—or at the left behind the transmitter, as shown in the photo of Fig. 4. The 10-KW transmitter employed in this arrangement provides power up to 100 KW, ERP, by utilizing an RCA high-gain antenna.

Film facilities are provided for station breaks and spots during network hours.

Although not shown in the photo of Fig. 4, the announce booth may be located separately or combined with the film room as described in the 1 KW (UHF) layout.

Another variation from the 1 KW (UHF) layout is the block "U" arrangement of the control console and turntables. In this setup, the operator faces the TC-4A Audio/Video console and transmitter. Monitors and equipment racks are easily accessible at the left and turntables at the right.

Centralized Control Console

Smooth and successful performance is made possible to a large extent by the proper grouping of important controls to make them easily accessible to the operator. This is accomplished by using the new RCA TC-4A Audio-Video switching console (which consists of two standard console sections) plus one film camera control and one TM-5A master monitor mounted in standard console sections. These four standard RCA console sections are arranged "in-line" (with the TC-4A sections in the center) to form the simple unified console of the "Basic Buy". This console, when coupled with a film camera

control, forms the nucleus of a complete television station operation, and may be used by small and large stations, as described later.

Film Camera Control Section

The section at the extreme left of the "Basic Buy" Console (Figs. 7 and 8) is required to house film camera control unit. In the upper part of this console section is a TM-5A master monitor which has a ten-inch picture tube and a five-inch CRO tube. In the lower portion of the housing is the film camera chassis. It supplies the blanking and driving signals to the film camera and reproduces a picture generated by the film camera. Controls for the adjustment of picture levels and shading are located on

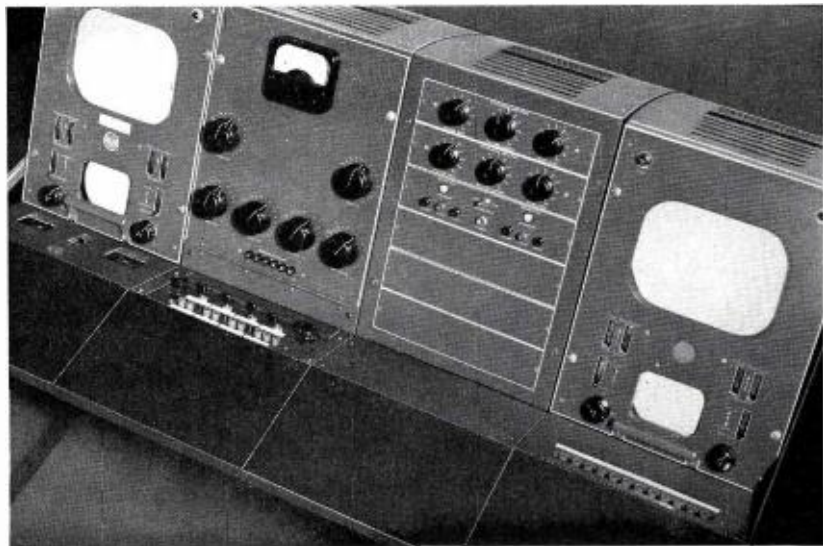

FIG. 7. Close-up view of the four console sections and associated control panels which are located on turrets and on sloping desk surfaces.

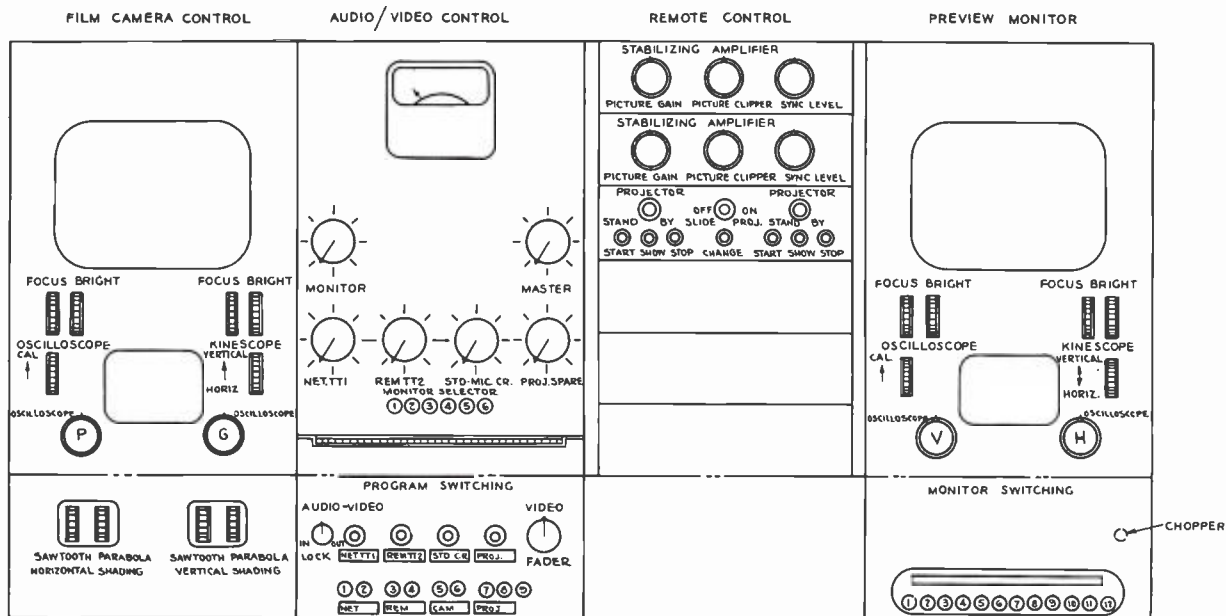

FIG. 8. Detailed layout showing the location of the "Basic Buy" console sections as well as controls, meters and switches provided.

the sloping desk panel of this console section. The film camera control is located at the left end of the TC-4A console for convenience of operation. However, the unit may be removed from this position if desired, and placed at another location without disturbing the functions of the remainder of this switching console.

The TC-4A Console Sections

The RCA TC-4A console is composed of the two center console sections (see Figs. 7 and 8) of the "Basic Buy" four-section operating console which provides audio and video controls and monitoring facilities.

All major console control panel circuits are brought out to coaxial connectors at the rear or bottoms of the panels to provide access for test, wiring or maintenance.

This console, plus the rack mounted equipment consisting of associated power supplies, amplifiers, jack panel and transmitter, may form a complete television station operation where network programs are available.

With the addition of a synchronizing generator, a film camera chain, slide projector, film projector, turntables, and microphones, this station is self sufficient in that it can

produce entertainment programs and commercial advertising. By adding other equipments, the programming facilities are expanded to produce more complex shows.

The two center console sections that comprise the TC-4A console, reading from left to right, are:

1. Audio control with combined audio-video program switching.
2. Remote control section.

TC-4A Audio-Video Section

On the sloping portion of the audio-video section (second from left) (see photograph,

Fig. 7) are located the program switching controls composed of one row of key switches for audio control, one row of pushbuttons for video control, a video clip-fader control and a tie switch for combining audio and video switching controlled from the video pushbuttons.

The combined audio-video switching is obtained by using relays. This system provides for eight inputs of audio and eight of video with one output for each.

Audio Control of "Basic Buy"

The audio portion of the "Basic Buy" provides for eight inputs to four mixer positions. Audio key switches provide means of selecting any input such as turntable, projector, studio, remote or network. The inputs are relay operated so they can be controlled by the video selector switch when desired, simplifying the audio-video combination switching. At the same time, it allows the audio and video switches to be closed together for convenient operation, and keeps the actual circuits apart to prevent crosstalk. The relays are interlocked to prevent accidental doubling of the circuits.

A selector switch allows a monitor amplifier and speaker to check most of the audio circuits including transmitter input and output, and turntable cueing. It is visualized that a separate cueing amplifier and speaker may be used in most applications.

One rack of equipment is needed in addition to the panel. This houses the pre-amplifiers; program, monitor, and limiting

amplifiers; and power supplies. Jacks are provided for all amplifier inputs and outputs.

Video Control of "Basic Buy"

The video pushbuttons also provide a means of selecting any one of eight signals, such as film, studio, monoscope, remotes or network for transmission. In addition, by using the "lock-in" switch on the left side of the panel, certain audio and video signals may be switched simultaneously by means of the video pushbuttons. When switching from local to remote or network signal, contacts on the switches provide automatic removal of local synchronizing signal.

On the right side of the switching panel is a remote "clip-fade" control. By means of this control, the signal may be faded to black, at which time an instantaneous switch may be made to a new signal, and then the new signal faded up.

Lap dissolves or superpositions cannot be made with this arrangement. However, with the flexibility of the RCA unit-type construction, other RCA equipments to accomplish this type of programming may be added.

TC-4A Remote Control Section

The other section of the TC-4A console (third from left) houses all the remote controls that are necessary to provide finger tip operation of those equipments that are necessary for simple basic programming.

The two top panels control stabilizing amplifiers. One of these amplifiers is for net-

work or remote signals and the second is for controlling any signal to the transmitter. The second stabilizing amplifier is also used for mixing the "sync" and video signals since some form of local signal is necessary for advertising purposes.

The third panel in this control is the projector switching control. Three groups of pushbuttons and tally lights are located on this panel, the groups at either end composed of three buttons and a separate lamp are identical while one pushbutton and toggle switch are located in the center. The center toggle switch is for turning the power on a slide projector. The pushbutton directly under the switch has a tally light built in and may be used to switch slides in the slide projector.

The tally light at the top of the panel at either end indicates when control has been transferred from the film projector to this remote operating position. The pushbutton on the left of the group is used to start the projector and has a built-in tally light to indicate that the machine is running. The center button of the group with built-in tally light is for transferring sound and picture from one machine to the other, when two film projectors are used. The third button is for stopping the projector, and does not have a built-in light.

Another group of buttons at the other end of the panel is identical and performs the same functions for a second projector.

Further controls may be added in the blank panel positions for additional film projectors, stabilizing amplifier, power switching, monoscope camera, or placed at various operating positions in the station where means of transferring control to other points is provided for by jack panels.

A pushbutton for chopper control is provided to select a calibrating signal for indicating percentage of picture modulation to the transmitter.

If only the TC-4A is purchased (without TM-5B Master Monitor), the pushbutton switches for monitor selection are mounted in the sloping desk surface of the "Remote Control" console section.

TM-5A Master Monitor

The fourth section at the extreme right-hand end of the console contains an RCA TM-5A master monitor, and on the sloping desk surface are located the pushbutton switches for monitor selection. Each switch is mechanically interlocked. Provision is

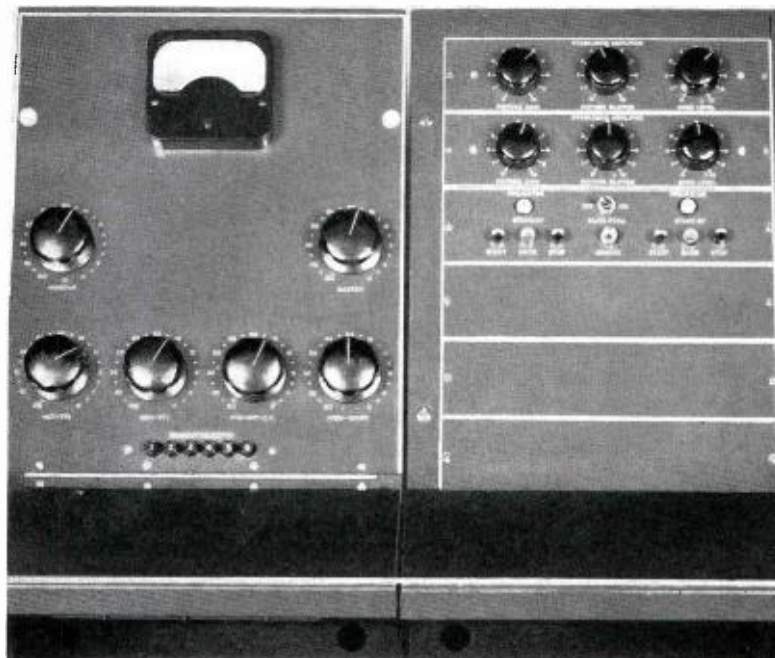

FIG. 9. Close-up view of the "Audio/Video" and "Remote Control" panels which together form the "TC-4A" equipment.

LIST OF MAJOR EQUIPMENT ITEMS FOR "BASIC BUY"

TRANSMITTER AND ANTENNA EQUIPMENT		NO. 3 — SYNCHRONIZING GENERATOR	
Qty.	MI Number Description	Qty.	MI Number Description
	Transmitter (UHF or VHF), including 2 Sets Crystals, 1 Set Tubes, Sideband Filter.	1	26915 TG-1A Studio Synchronizing Generator complete with Tubes and Cabinet Rack (incl. Doors and End Shields).
	Set of Operating Spare Tubes.		
	Antenna (UHF or VHF), including Diplexer.		
	Sheet Melting Equipment.		
	Dummy Load.		
55	19113-1 Transmission Line, 3/8", 51 ohm, flanged, 20-foot sections.	1	30951-DB4 NO. 4 — TRANSMITTER MONITORS
50	19113-14 Dual Spring Hangers.	1	8R-84D Cabinet Rack and Rear Door.
1	On Application Signal Demodulator Type BW-4AL/AH or WM-20A for VHF, and BWU-4A for UHF.	1	Type BW-6AL/AH or BWU-6A Frequency and Modulation Monitor with one set of tubes.
		1	WF-50B Carrier Frequency Monitor.
		1	WF-9C Frequency Deviation Meter.
		1	57-D Switch and Fuse Panel.
		1	Blank Panel—5 1/4".
		1	WM-71A Distortion and Noise Meter.
		1	WA-28A Push Button Oscillator.
		1	Blank Panels—7.
		1	30532-G84 Meter Panel Door, Right Hand.
		1	Meter Panel (for extension meters).
		1	Remote AM Carrier Deviation Meter.
		1	Remote FM Carrier Deviation Meter.
		1	Remote FM Modulation Monitor Meter.
			NO. 5 — AUDIO RACK
		1	8R-84E Cabinet Rack less doors.
		2	Ventilated Doors.
		1	8A-6A Limiting Amplifier (incl. Panel).
		1	Shelf for 8A-6A.
		1	Tube Kit for 8A-6A.
		1	8I-1B Meter Panel.
		2	8J-24 Double Jack Panel.
		4	Patch Cords, 2 foot.
		4	8A-11A Pre-Amplifiers for Turntable and Microphone Circuits.
		4	Tube Kits for 8A-11A.
		1	8A-13A Program Amplifiers for Network and Microphone Circuits.
		1	Tube Kits for 8A-13A.
		1	8A-14A Monitoring Amplifier.
		1	Tube Kit for 8A-14A.
		1	BX-1E Power Supply.
		4	8R-2A Panel and Shelf.
		1	8X-6A Relay Supply.
		1	Terminal Board Bracket.
		1	26313 Sound Equalizer (for 16mm Projector).
		1	4568 Power Terminal Block.
		1	26581 Panel and Shelf for Sound Equalizer.
		1	4569 Audio Terminal Block.
		1	4395-G 57-D Switch and Fuse Panel.
		1	4592-B Blank Panel—5 1/4".
		1	4595-B Blank Panel—10 1/2".
			Note: Cueing amplifier and speaker optional equipment.
			MISCELLANEOUS EQUIPMENT
		2	70-D Turntables.
		1	77-D Microphone.
		1	4092-D 91-B Desk Stand.
		1	11411 LC-1A Speaker Mechanism.
		1	11406 LC-5A Wall Baffle for MI-11411.
		3	26298 TM-28 Utility Monitor.
		3	26533 Speaker Accessory Kits for TM-28.
			PORTABLE TEST EQUIPMENT
		2	WO-798 3" Portable Oscilloscope.
		1	WV-97A Senior VoltOhmyst.
			NO. 1 — POWER SUPPLIES
		1	8R-84E Cabinet Rack, less doors.
		1	Doors, ventilated.
1	30951-E84 8R-84E Cabinet Rack, less doors.	1	11225 8A-6A Limiting Amplifier (incl. Panel).
2	30535-G84 Doors, ventilated.	1	11599 Shelf for 8A-6A.
2	21523-C 580-D Power Supply for Stabilizing Amplifiers.	1	11267 Tube Kit for 8A-6A.
3	26085-B WP-33B, Power Supplies for Master Monitor, Film Monitor and Film Camera.	1	11388 8I-1B Meter Panel.
		1	11645 8J-24 Double Jack Panel.
		4	4652-2B Patch Cords, 2 foot.
		4	11231 8A-11A Pre-Amplifiers for Turntable and Microphone Circuits.
		4	11288 Tube Kits for 8A-11A.
		1	11233 8A-13A Program Amplifiers for Network and Microphone Circuits.
		1	11266 Tube Kits for 8A-13A.
		1	11234 8A-14A Monitoring Amplifier.
		1	11267 Tube Kit for 8A-14A.
		1	11305-D BX-1E Power Supply.
		4	11598/11599 8R-2A Panel and Shelf.
		1	11315 8X-6A Relay Supply.
		1	4570-A Terminal Board Bracket.
		1	26313 Sound Equalizer (for 16mm Projector).
		1	4568 Power Terminal Block.
		1	26581 Panel and Shelf for Sound Equalizer.
		1	4569 Audio Terminal Block.
		1	4395-G 57-D Switch and Fuse Panel.
		1	4592-B Blank Panel—5 1/4".
		1	4595-B Blank Panel—10 1/2".
			NO. 2 — VIDEO RACK EQUIPMENT
1	30951-E84 8R-84E Cabinet Rack less doors.		
2	30535-G84 Doors, ventilated.		
1	26960-A TK-1B Monoscope Camera (incl. Tubes).	2	11801-B 70-D Turntables.
2	26160-B TA-5C Stabilizing Amplifiers (incl. Tubes).	1	4045-C 77-D Microphone.
1	26244 Video Jack Panel.	1	4092-D 91-B Desk Stand.
5	19118 Video Jack Plug.	1	11411 LC-1A Speaker Mechanism.
4	7233-4 Video Jack Cord—24".	1	11406 LC-5A Wall Baffle for MI-11411.
1	21523-C 580-D Power Supply for Monoscope Camera.	3	26298 TM-28 Utility Monitor.
1	4395-G 57-D Switch and Fuse Panel.	3	26533 Speaker Accessory Kits for TM-28.
1	4592-B Blank Panel—5 1/4".		
1	30003-A WA-3A Grating Generator.		
1	30021-A WA-21A Video Sweep Generator.	2	PORTABLE TEST EQUIPMENT
1	4590-A Blank Panel—1 3/4".	1	WO-798 3" Portable Oscilloscope.
			WV-97A Senior VoltOhmyst.

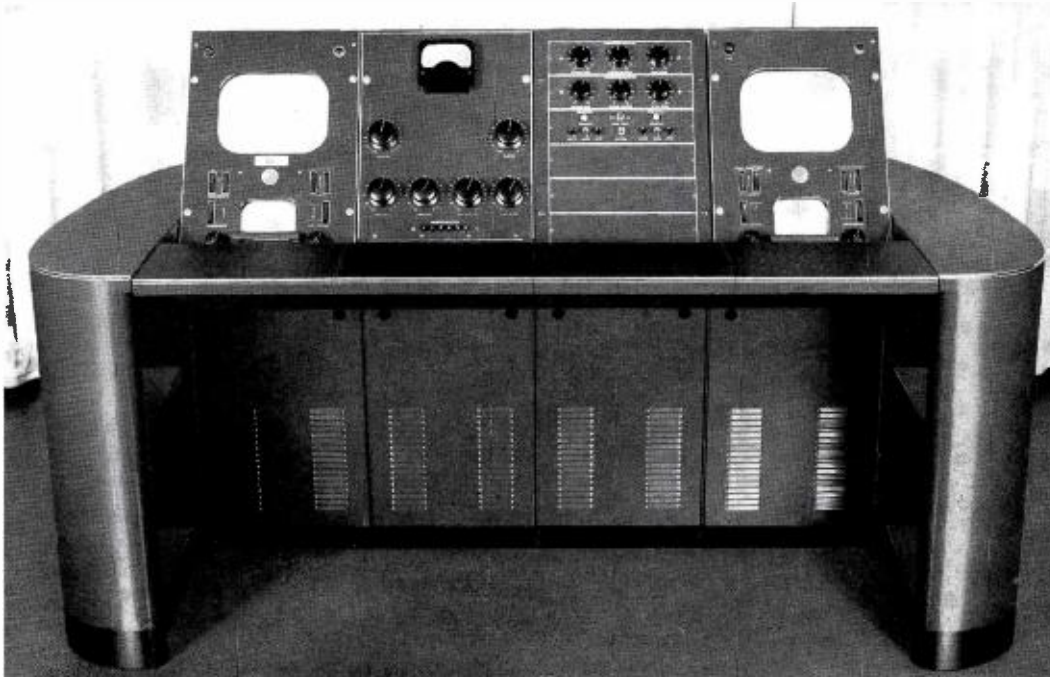

FIG. 10. View of the overall "Basic Buy" console complete with finished end sections, as normally used in the television station.

made for twelve inputs and one output. This unit may be used to monitor all the necessary transmitter signals in addition to serving as a preview monitor for remotes and networks. In the normal position, this monitor will register the line signal.

“One-Man” Operation Possible

With the arrangement shown, the “Basic Buy” console could easily be operated by one man. All of the necessary controls for programming are centralized in the 4-section “Basic Buy” console except the audio and video jack panels which are located in nearby equipment racks.

Even with the addition of one or two film camera controls, it would also be possible for one person to handle both network and film programs. However, many stations will prefer to use two operators, and two are easily accommodated with the proposed arrangements.

Application Flexibility

Inspection of the block diagram (see Fig. 6) makes it apparent that this console or any section of it may be used for various purposes at locations remote from the transmitter. For example, the preview monitor and audio console could be used in a studio control room or remote position along with the other video equipment.

Similarly, the remote control section could be used in a studio control room or master control.

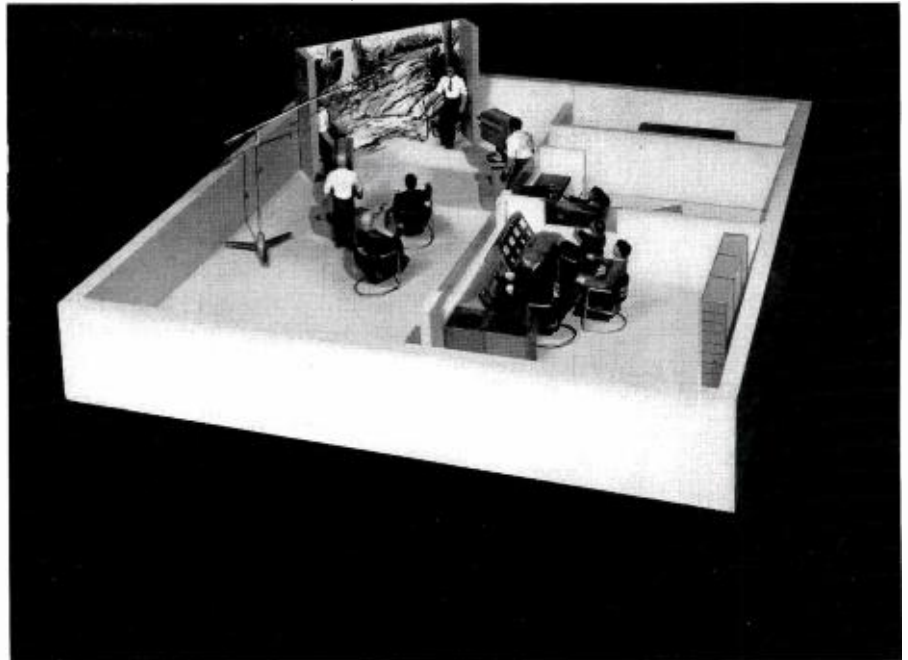

FIG. 11. Model layout showing a typical single “live talent” studio which can be added to the “Basic Buy” station at any later date.

Some applications of the TC-4A switching console are:

1. Small station operation (no studio) with all equipment at transmitter site.
2. Larger station operation with TC-4A console and film equipment at the transmitter location or master control

for “off hour” use when the studios are in rehearsal or shut down.

3. Large station operation same as 2 except that the transmitter is remote from the studios.

Because of the unit construction of this console, it is possible to obtain any of the individual console housings for uses at various locations. For example, the audio console may be used at remote points and the monitoring console may be used in the studio control room if and when studios are added. Also, it is possible to set up the four console sections as individual, dual-unit consoles to suit a particular floor plan or operating arrangement (see Fig. 4).

Future Studios

The future addition of a single live talent studio to any “Basic Buy” station is quite easy to accomplish. Since a television studio may be considered as simply another signal source such as remotes or network—studio arrangements can be planned separately from the “Basic Buy” facilities.

A typical single studio might be arranged in the manner shown in Fig. 11. The facilities for a live-talent studio could be located as (1) a second floor of an existing building, (2) expansion of building at the same level, or (3) a studio remote from other facilities.

A LIST OF THE MAJOR ITEMS OF EQUIPMENT NEEDED FOR THE SINGLE STUDIO ARE LISTED BELOW:

Item	Quantity	Description
1	2	Studio Cameras, Control Units and Power Supplies (Type TK-10A)
2	2	Studio Camera Pedestals (TD-1A) and Friction Heads (MI-26205)
3	1	Microphone on Boom Stand (KS-4A or MI-26574)
4	1	Studio-Video Switching Equipment (TS-10A)
5	1	“On Air” Master Monitor (TM-5A)
6	1	Audio Console (BC-2B)
7	2	Turntables (70-D)
8	1	Studio Sync Generator (TG-1A)
9	2	Racks containing power supplies, distribution amplifiers, video and audio jacks, etc.

Refer to the “RCA Broadcast Equipment” catalog for a complete description of these items.

WFIL GOES “45”

By **LOUIS E. LITTLEJOHN**
Chief Engineer
Philadelphia Inquirer Stations
WFIL—WFIL-TV

Radio Station WFIL has converted their 70-D turntables to incorporate the new lightweight pickup and tone arm—thus fulfilling the need for a high-quality broadcast pickup combination for playing fine-groove 45 rpm records. The new pickups

and tone arm are designed to function together and with this arrangement offer many outstanding features and advantages over previous units. The pickup is available in two diamond stylus sizes (1 mil stylus for fine groove and 2½ mil stylus

for standard transcription and 78 rpm records). These are readily interchangeable as “plug-in” units.

Since converting the standard RCA 70-D turntables, the station has been broadcasting regularly scheduled “45” disc jockey programs. With a collection of more than 5000 selections on 45 rpm discs constituting the WFIL record library, the station will continue to feature 45 rpm records on its many recorded music programs.

To inaugurate WFIL’s “Change-to-45”, an intensive week-long advertising and promotion campaign was sparked by personal appearances of Mindy Carson at WFIL’s AM and TV studios. Promotion was further intensified by a “super-saturation” schedule of 1000 announcements by WFIL during the first week. Full-page newspaper ads, special dealer tie-in window displays and a roving 45 rpm float, daily touring the city’s streets, publicized the event.

In the 45 rpm system, WFIL has found the answers to numerous space problems which confront many broadcasters of recorded music programs. The small size of the records and the simplicity of the equip-



Meyer Posner, Engineer, looks on as (l. to r., standing) Thomas F. Joyce, Vice-President and General Manager of Raymond Rosen Company, J. B. Elliott, Vice-President in Charge of RCA Consumer Products, and Roger W. Clipp, General Manager of Philadelphia Inquirer stations WFIL—WFIL-TV, inspect transcription turntables converted to play fine groove 45 rpm records.

Bob Horn, WFIL disc jockey (at left) with Mindy Carson, who made personal appearances on a week-long program inaugurating WFIL’s “Change-to-45.”





Close-up of the RCA lightweight pickup and tone arm that fulfills the need for a high-quality broadcast pickup combination. Adds versatility to 70-series transcription turntables—permits you to go “45”.

ment effect a tremendous saving in valuable storage space. Programming is facilitated by efficient record handling by disc jockeys and record librarians, thus streamlining the entire recorded music operation. To these considerations must be added the superior reproduction quality and fidelity of 45 rpm records, which provide increased listening pleasure for audiences.

Simplicity of the Changeover

A 45 rpm Conversion Kit is available to broadcasters for quick and simple modifi-

cation of any 70-C or 70-D transcription turntable. The modification requires minimum time and minimum investment. The kit contains a ball-type speed reducer which is installed between two flexible couplings in the main drive shaft. In one position, the ball reducer is inoperative and the shaft is driven directly by the motor-speed reduction gear at 78 rpm. In the other position, the ball reducer drives the shaft and fly wheel at 45 rpm. An over-riding springclutch is built into the new

mechanism and is operative in both positions. Speed change is accomplished by turning the speed control knob on the turntable deck. It may be shifted in either direction while the turntable is in operation. The speed-control shaft passes through the center hole of a new dial plate which now includes three positions: (1) an “OFF” position which completely shuts off the turntable by turning off the motor; (2) a “78”-“33 $\frac{1}{2}$ ” rpm position which permits operation at either speed by use of a speed-change lever on the turntable; and (3) the 45 rpm position which permits operation at this speed with the speed-change lever set at “78”. A hub adapter, to accommodate the large center hole of the 45 rpm records, is placed on top of the turntable spindle.

A minimum amount of electrical work is necessary such as transfer of the motor switch leads to the microswitch which is included in the kit.

Modification of the existing filter is required with the new lightweight pickup and tone arm. This modification may be simply accomplished by addition of a few small components such as capacitors and resistors which are supplied in kit form.

Additional material on filter modification will be found in “How to Use Standard Filters with New Flat Magnetic Pickups” —BROADCAST NEWS No. 58, page 4.

Components are supplied in kit form for changeover of 70-series turntables to play three speeds.

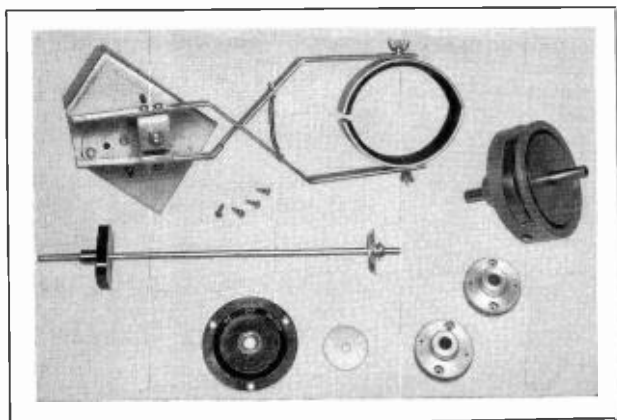

(Extreme right) — Interior view of a 70-series turntable conversion with all kit parts installed.



TELEVISION MICROPHONE TECHNIQUES

by **WHITNEY M. BASTON**
NBC Engineering Department
New York City

Many of the microphone techniques which have been successfully used on standard broadcasting may also be used in television programming. From the standpoint of microphone techniques, TV shows may be classified into three major groups: Programs, in which the visual presence of a microphone or microphones is accepted as part of the program (panel discussion shows, sporting events, news programs and some types of interview programs, dance orchestras and small informal musical productions, etc.).

Programs in which some microphones may be visible while others are not (amateur programs, quiz programs and some variety programs).

Programs in which microphone appearance would be a disturbing element (dramatic shows, large variety programs and interview programs where an air of informality is to be preserved, etc.).

The microphone techniques for shows in which the appearance of the microphone is not considered objectionable are, in general, similar to usual sound broadcasting practice. One important difference is that the microphone must not obscure the artists or other important scenic elements.

It should be emphasized that no hard and fast rules can be laid down for TV audio techniques, each situation must be explored for its full potentialities. In all cases the final criteria of achievement is the creation of an effect which is judged to be most satisfactory from all standpoints. Television, being a medium which

combines sight and sound for the creation of entertainment, necessarily leads to a measure of compromise between the audio pickup techniques and the visual requirements of the programs. The general tendency is that such compromises place an additional burden on those charged with the responsibility of obtaining the optimum sound pickup; in a similar fashion, the audio requirements frequently limit the scope of action of those concerned principally with the visual elements of the program. The ideal television program would, of course, combine the best audio pickup with the most suitable visual effects.

The direction taken by such deviations from the ideal must be dictated by the needs and scope of the program. There would be no question that on a program featuring a concert orchestra the end product of which is the enjoyment of good music, no compromise of sound quality would be considered; however, many of the lovely creatures who perhaps too frequently flit across the screens of the nation can, in the opinion of many "experts", be thoroughly enjoyed in complete *silence!* It is a safe assumption then, that typical TV programs will present audio pickup problems somewhere between the two extremes illustrated above.

Radio broadcasting has concentrated on the creation of many illusions and effects through the medium of the spoken voice. Delicate shades of meaning and emotional states can, and are, artfully produced by trained voices. The audiences have been conditioned to this circumstance and this

highly developed art has been understood and enjoyed for many years. The techniques necessary to capture each subtle nuance of meaning in terms of tone shadings would call for microphone placement, which despite any of the visual requirements of TV, might be considered as either undesirable or unnecessary in TV programming. These subtleties can be conveyed perhaps more naturally and effectively in TV by the facial reactions and movement of the artist.

The audio man making the transition from sound broadcasting to TV must be prepared to change his concepts to meet the needs of the new art. It is almost axiomatic that a TV program is never a radio show with cameras, but rather an entity unto itself. The above does not suggest that the audio man forego any attempt to obtain suitable sound pickup in TV, but rather that he should be cautious in applying sound-broadcasting standards to TV programming.

Certainly, there is a very large area of agreement in the general methods used to obtain good audio pickup in both media and the audio man undertaking TV assignments will draw heavily on his broadcast experience, but he should also preserve an open mind to some of the seeming conflicts which occur. Experience has shown that these men make the transition easily and that their broadcast experience is a distinct asset.

It has long been recognized that the ideal television studio should be able to

FIG. 1. RCA Microphones
Type 77-D at left and
KB-2C at right.



provide many different acoustic conditions varying from outdoor scenes to interiors of large halls and small living rooms. The current practice in most instances is to keep the actual reverberation characteristic of the studio as low as possible. The reverberant effect furthermore helps to muffle to some extent the background noise from off-the-set activities. Liveness can then be gained by the addition of hard flats which constitute the scenery, sacrificing weight but retaining high frequency reflections. The rather wide use of sets having hard surfaces frequently alters the acoustic characteristics in the microphone pickup area and suitable adjustments must be made in microphone placement. Sometimes acoustic absorbent flats are used as a band shell and enclosure to isolate an orchestra from the cast when both groups are functioning within the same television studio.

The types of microphones currently in use in television range from the familiar broadcast types, such as the 77-D, 44-BX, 88-A, to the new small models like the KB-2C and the new pencil type microphone exemplified by the "Starmaker."

The problem of sound pickup on TV programs includes many considerations not present in sound broadcasting. One of the most important points that must be considered is that of unwanted noise which is the natural result of motion of the actors, cameras, microphone boom, scenery, etc., all necessary to the show, but collectively a source of noise which must be minimized if a successful sound pickup is to result.

A convenient concept is to consider the existence of an imaginary line drawn between the scene of action and the camera. With this division, it will be found that a large majority of the unwanted noise will originate on the camera side of the line and almost all of the desired sounds from the particular scene will originate on the other side of the line. Such a set of circumstances suggests the use of a uni-directional microphone, such as obtainable with the RCA 77-D. A consideration of typical TV scenes would suggest that the imaginary line referred to above would shift from scene to scene, it is obvious then that the microphone must be movable. The boom provides the answer to this problem; typical boom microphones are arranged so that from one position of the boom the microphone can be moved a distance of 10 feet and can swing in an arc of 280° with adjustable radius from 7 to 17 feet. In addition to the horizontal motion, the microphone can be raised and lowered above and below the horizontal. The microphone is

thus capable of occupying various positions in a rather large solid angle.

Approaching the ambient noise problem from a somewhat different point of view the signal to noise ratio *at the microphone* is determined by the ratio which exists between the direct or desired sound and the unwanted sound. It is obvious that an increase in the direct sound level will be desirable. This can be done by following the action with the boom microphone so that the distance between the performer and the microphone where desirable is kept reasonably constant at perhaps 3 feet or slightly more. The directional pattern most frequently used in TV is the uni-directional pattern; however, many uses exist for bi-directional and spherical pickup patterns. Examples of typical program setups given later will show uses for the several patterns. In the foregoing somewhat over-simplified explanation of the use of the boom microphone, no mention was made of some of the practical day to day problems which arise.

The usual use of a boom microphone is for scenes in which the microphone should not be seen by the television audience. The scenes taken by the TV camera will range from closeup to wide angle shots, so that a boom microphone positioned for good sound pickup on a closeup would be in the picture on a medium or wide angle shot. In usual studio practice the audio engineer or mixer previews the picture on a TV monitor and talks to the boom operator over the inter-communication system advising him of the position of his microphone and warning him if there is danger of the microphone showing in the picture. If such a danger should be present, and

it invariably is, the boom operator must either raise the microphone above the artist or "rack" the boom in, i.e., shorten the length of the boom arm. Obviously the change in the position of the boom microphone will influence the quality of the sound pickup. Had the microphone been positioned near to the artist for the closeup, moving it up or away would cause a marked change in quality. It is often the usual practice to anticipate such changes and not bring the microphone too near the artist on the closeup, so that the change in quality when the microphone is moved, will not be too pronounced.

Consider a scene in which two persons are engaged in a conversation and the action calls for them to separate while still carrying on the conversation. Such a case is usually called a "split" and is handled in several ways, depending on the circumstances. In some cases no preference is to be given to either person as far as microphone pickup is concerned; in this case, when the actors were close together the microphone would be placed a reasonable distance away, so that when the "split" occurs the quality will be substantially the same as on the closeup.

Frequently, however, the boom operator is instructed to "favor" one character or the other. A possible example of such a scene would be where a principal is seated and is approached by a servant who says a few words when close, and withdraws to the rear to answer a question. Here, since the servant is seen to go toward the background, a somewhat thinner quality would be expected and would seem entirely natural, so that the boom microphone would

FIG. 2. Studio scene showing the use of the "Starmaker" mike in an informal interview.



not necessarily follow the servant. Other examples are combinations involving a strong male voice and a rather thin female voice, usually in such cases the weaker voice is favored. In many instances one actor may be seated and another standing so that the distance from the microphone to each actor must be adjusted by selecting a suitable compromise position. It is obvious that one microphone cannot be expected to take care of all situations; in some instances concealed microphones are used to pick up one or more of the voices.

Where several microphones are required great care should be exercised in selecting microphones of similar effective frequency response characteristics to that of the boom microphone to avoid a noticeable change in sound quality in going from one microphone to the other. It is also important that such changes be kept to an absolute minimum because in most cases concealed microphones are placed in close proximity to a variety of surfaces or objects which lead to serious wave interferences and undesirable phasing effects.

Recently, great strides have been made in developing unobtrusive microphones which are small enough to be hardly noticeable if carefully blended in with the surroundings without sacrificing the acoustical properties of these transducers (Fig. 1). Because of the bi-directional pattern of the RCA KB-2C, some care must be exercised in its use, but if the ratio of direct sound to reflected sound is large enough, this microphone can be used to excellent advantage. For close talking purposes this

microphone has been modified for still better discrimination against background noise.

A small pressure type microphone has also been developed for applications where the ambient noise level is not high in relation to the useful sound level and where directional discrimination is not required. This microphone, known as the "Starmaker", has proven particularly suitable in audience participation shows where an announcer carries the microphone to someone being questioned or interviewed; this microphone can also be included in a set at a fixed location without detracting from the principal subject. Fig. 3 illustrates the use of this microphone.

One of the most serious problems faced in microphone placement for television is the ability to make the sound accompanying the picture suit the apparent distances shown. Two means are available in achieving the purpose which sometimes is referred to as "sound perspective". One is by controlling the apparent reverberation either electrically by the use of filter circuits or through an echo chamber and the other is by control of the volume or loudness level. Thus, if a camera is to be used to take a long shot, the volume associated with it is turned down an appropriate amount to produce the desired psychological effect and the reverberation control opened to give an increase in the apparent reverberation effect. Another scene taken by a camera having a long focal length lens for a closeup shot would require more direct sound and full volume. Such a system implies an auto-

matic switching arrangement between camera and audio controls and is necessarily complicated, requiring great skill and long rehearsals to avoid ludicrous effects which might completely nullify the intent of the picture itself. Sometimes a solution is automatically obtained by merely raising the microphone boom far enough to be out of the picture, giving the desired overall effect. The difficulty, however, lies in returning to the subject on a "closeup" rapidly enough so as not to lose the sound.

It is customary on the larger dramatic and variety presentations for the audio engineer to attend the "dry rehearsal". This is effectively a meeting held by the production staff, the technical director, the lighting director, and the audio engineer. All concerned discuss various points concerning their special field of interest. At this meeting the audio man sizes up the over-all situation and brings attention to any trouble spots. Quite often the originally planned boom moves may be very difficult, impractical or the element of risk too great, by discussing the problem with the group, compromises may be worked out so that before the actual rehearsal gets under way the audio man has had an opportunity to make more definite plans for boom placement, etc. When a "tight" situation develops, for example a change of microphone placement which cannot safely be made in the time as originally allotted, the director may rearrange the scene slightly to give the boom man time to move.

The devices used to gain time are many and varied. One example would be where a character on leaving a room says, "Goodnight" as he walks through the door, this scene might be followed by action elsewhere on the set. The boom microphone must be moved from the door to the other action almost instantly. The scene may be rearranged so that "Goodnight" is said while he is a few feet from the door, he then turns, smiles and leaves. During the period of silent action the boom operator has a chance to make his move.

Many productions are carefully planned in advance and a layout is prepared on a floor plan of the studio which has cross-section lines each representing one foot spacing so that the position of sets, cameras, booms, etc., may be outlined and trouble spots analyzed in advance. Fig. 4 shows the floor plan of a typical studio. It is not unusual for additional changes to be required but this method saves time particularly on larger shows.

The boom microphone positions and moves must be made so as not to interfere

FIG. 3. Studio scene illustrating the use of the RCA "Starmaker," an unobtrusive microphone.



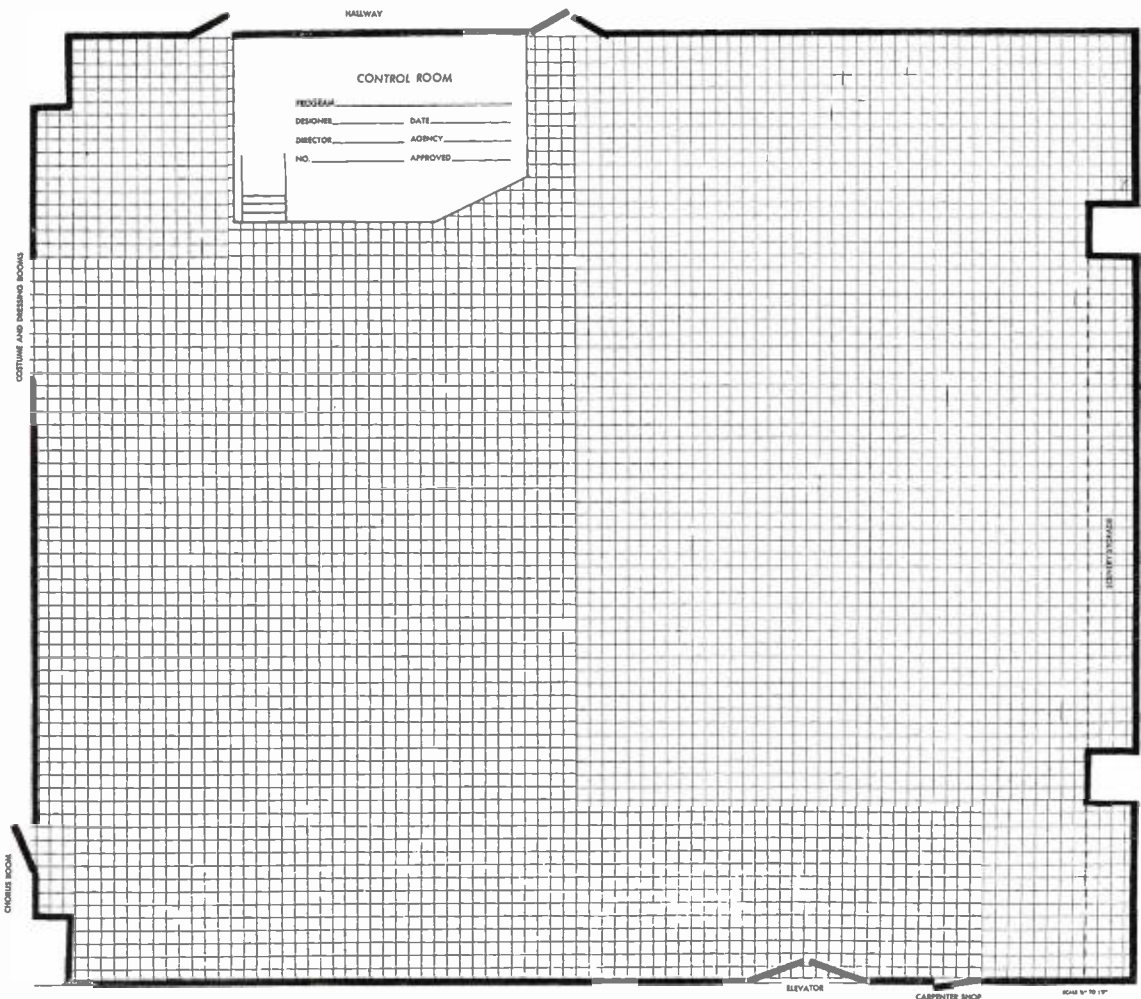

FIG. 4. Sample studio floor plan which may be used to plan "Mike" placement in advance.

with the freedom of movement of the camera, artists, technicians, or other personnel. This calls for very careful planning of each boom position necessary for the particular show. Every effort should be made to find locations for the boom which will permit a maximum area to be covered with a minimum of boom moves. It is also necessary to plan the moves so that after a run-through the boom may be easily returned to its original position for the beginning of the rehearsal or air show.

The use of the boom microphone on TV shows, moving as it does from one position to the other, often leads to boom shadow problem. The boom should be positioned with respect to the principal source of illumination so that the microphone shadow does not fall on the faces of the artists, on sets, or other places where it would be disturbing to the scene. The lighting man

and the boom man must work out the problem so that shadow-free shots are obtained.

On large shows where many boom positions are used it is customary for the boom man to mark the boom positions on the studio floor, so that after the rehearsal the boom can be placed in the exact position for the air show. The boom must compete with camera, sets, props, etc., for floor space. Where fast boom transitions are to be made, it is imperative that the boom be accurately positioned. Fig. 5 shows a layout of a typical television studio as used for an average network show.

Some examples of shows in which the microphone is visible in the picture and which are generally handled very similar to radio programs are "Who Said That", a panel type of show in which 77-D microphones are placed in wells in the panel table and while inconspicuous are

actually visible; "Americana", a quiz type of program in which 77-D microphones were concealed in school desks. Fig. 2 shows the "Starmaker" used on an informal interview program.

The Ford show, featuring Kay Kayser, used boom microphones for skits, etc. and visible microphone for the orchestra. The interviews between the MC and the contestants were picked up by a 77-D placed on the lecturn in full view of the audience. The "Lucky Strike Hit Parade" uses some visible orchestra microphones, while the balance of the show is picked up either on boom microphones or other concealed microphones. News programs usually feature visible microphones and are quite similar to the radio counterpart in presentation. Most of the simpler dramatic programs are done entirely by boom microphones and occasional transition microphones.

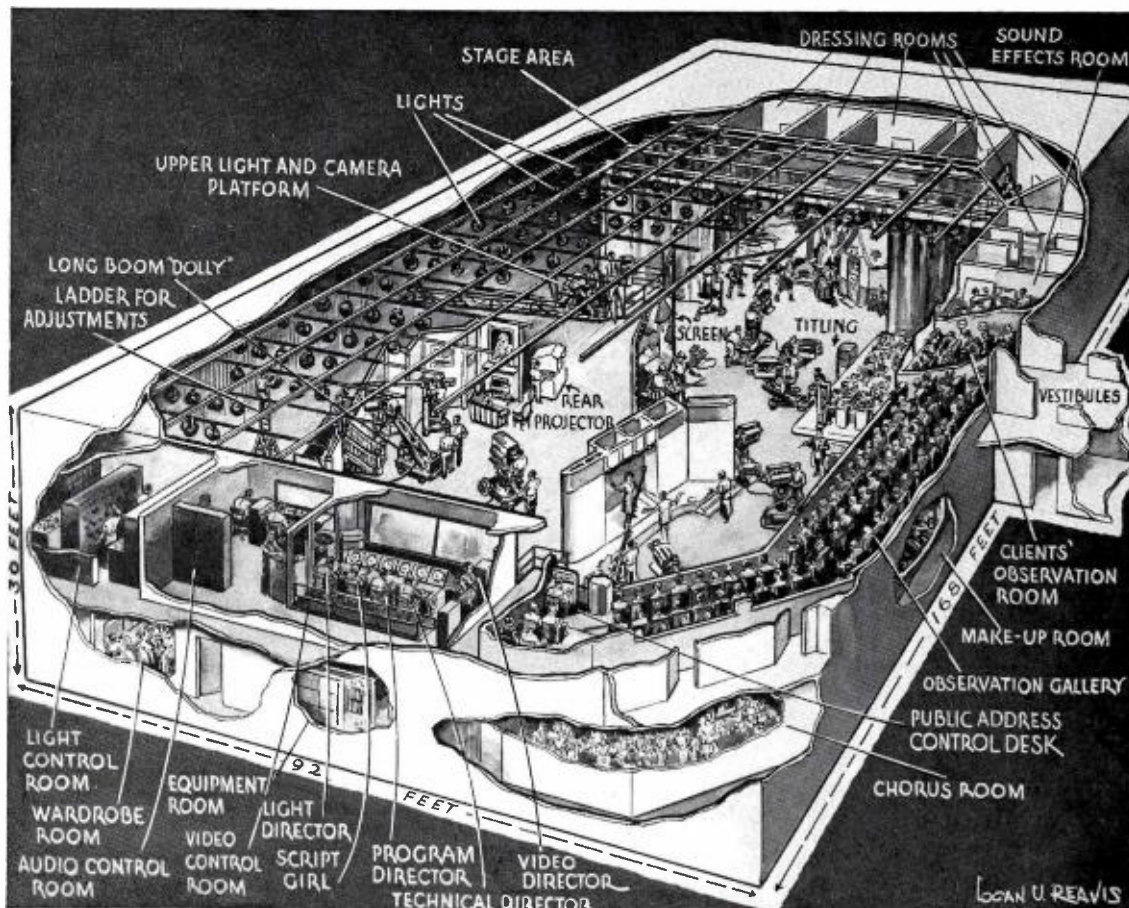

FIG. 5. Layout of a typical TV studio as used for an average network show.

Some of the larger dramatic shows, such as Philco Playhouse, and Kraft Television Theater, etc., often use as many as three boom microphones and in many cases a total of ten or more microphones. Programs which feature vocalists who accompany themselves on the piano frequently open at the piano and after a short interlude the vocalist leaves the piano often continuing the song to the accompaniment of a small orchestral group. To cover the transition, a microphone is placed just above the key-board of the piano on the far side away from the camera. The two microphones should be of the same type so that when the artist arises from the piano and the boom microphone takes over to follow the subsequent action no noticeable change in quality is evident.

Some typical examples of concealed microphones placement which have been used are as follows: action calls for a character to talk into old fashioned wall type telephone located near a corner, a microphone

on a regular stand was set up next to the telephone but just around corner, in this particular scene only a small area around the phone was visible so that microphone did not appear. The more obvious methods of concealment such as behind books on desk or table, behind flower, etc., are frequently used. Where foliage is used on sets, the pencil type microphones have been concealed in bushes and trees, etc.

In one dressing table scene, a microphone was concealed in a box used for cleansing tissues, in another scene of a theatrical dressing table, the microphone was placed near the mirror and was concealed by placing a few telegrams in the mirror frame. This is a customary habit of theatrical people and the appearance of the telegrams in the picture would be perfectly natural. Perhaps this illustration points out an important idea in concealed microphone placement—seek some perfectly natural object to shield the microphone from view. A pencil type microphone concealed in a

corsage of flowers has been used very successfully in some scenes. This type of microphone has also been concealed behind a man's tie, the camera avoided the lower portion of the artist's body so that the microphone cord was not seen.

On one program which features a ventriloquist and his friend, interviews are held with members of the audience who are directed to a chair on stage. The microphone is placed behind the chair out of view but in a good position to pick up both the guest and the performer. In presenting a ventriloquist's show, the audioman has been known to bring the boom microphone closer to the dummy for its part of the dialogue, a perfectly natural mistake.

Once in a while the selection of a place of concealment leads to a situation which earns a chuckle when retold, but which is not so humorous at air time. In a scene on one of the largest shows on the air, a

vocalist was shown singing a song while lying on the grass in a typical hill-billy scene—to add a touch of rural atmosphere, a live goat was on stage also in the scene. The microphone used for this pickup was hidden behind a log; during the song, impelled by motives of his own, the goat started to lick the microphone—the resulting sounds were not exactly musical.

No hard and fast rules can be stated for correct microphone placement, but some general principles can be outlined. The boom microphone usually is placed from three to five feet in front, and about two feet above an artist, with the microphone inclined at a 45° angle. It is the usual custom to use the 77-D microphone with its uni-directional pattern and in one of the voice positions. This setting is also quite common for musical pickup, largely because of the increase in pickup of extraneous noise which is prevalent during most TV programs.

During rehearsal or during unrehearsed programs the boom microphone is often inclined so as to be almost parallel to the floor. This lessens the discriminations be-

tween sounds from several sources, and while it does not give optimum results, it greatly reduces the number of moves necessary during a rehearsal.

Rapid movement of the boom microphone should be avoided because of air noise, caused by air rushing past the ribbon. In working too close to several subjects, rapid turning of the microphone should be avoided because of mechanical noise caused by the motion of the microphone hanger.

Because of the ever present danger of a microphone appearing in the scene, it is a natural reaction for many boom men to keep the microphone high, even when a better pickup would be possible. As an aid to detecting the boom before it actually is seen in a shot, some engineers attach a piece of string about a foot long to the microphone, in this way the string appears in time to give a warning.

During the average TV show the microphone will be used on closeups and may be quite close to the camera. If the camera blower motor is running its noise may be heard; it is customary to turn off the

blower before such a scene. Some instances have occurred in which the filament of lamps in lighting fixtures has made a singing noise, this usually indicates a defective lamp, which when picked up by the microphone can be very annoying.

A word of caution is in order, the boom microphone is quite heavy and in the course of its operation care must be exercised to see that *both* ends have freedom of motion. The counter-weight may strike a person while it is being swung around during the operation of the boom. The counter-weights which balance the microphone should be adjusted carefully for the *particular* microphone used, if this is not done the boom will be unbalanced and will be difficult to handle. If the counter-weight is too light the microphone will drop downward, when the locking screw is released, and may also inflict injury on persons below the microphone.

Acknowledgment is due Mr. H. Gurin of NBC for much of the information contained herein, also to the many engineers in NBC who have contributed many of the actual examples included.

FIG. 6. TV studio scene showing the use of a "boom" microphone.





FIG. 1. The facial image of Chief "One-Bull", a Sioux Indian, is famous as a monogram for KOTA and presents a friendly welcome to visitors to the Black Hills. The word "KOTA" means friend in Sioux Indian language and also is used to denote Sioux Indian. Slogan of KOTA is "Chief Signal Station".

◆◆◆ AND
KOZY

Rapid City, South Dakota

By
A. E. GRIFFITHS
 Chief Engineer,
 Black Hills Broadcast Co.

Radio station KOTA in Rapid City, which has completed fifteen years of service to the Inland West, sent its first broadcast over the airways on Thanksgiving Day of 1936. Original construction permit application was made in 1933 by Robert J. Dean, the present manager and President of the Black Hills Broadcast Company of Rapid City, the corporation by which KOTA and KOZY are owned and operated.

In 1937, a power increase was authorized and the station went from 100 watts, fulltime, to 250 watts, fulltime, with their first new RCA transmitter. In 1940, application was made for a second power increase, this time to 5-kw but, because of the advent of the war, that authority was not given hastily. In fact, it was not 'til 1945 that this increase was made valid and put into effect.

— EXISTING PARTITIONS & WALLS
 - - - NEW FRAME PARTITIONS
 - · - · - PARTIAL PARTITION

FIG. 2. Floor plan layout of KOTA executive and staff offices which are located in the basement of the Alex Johnson Hotel.

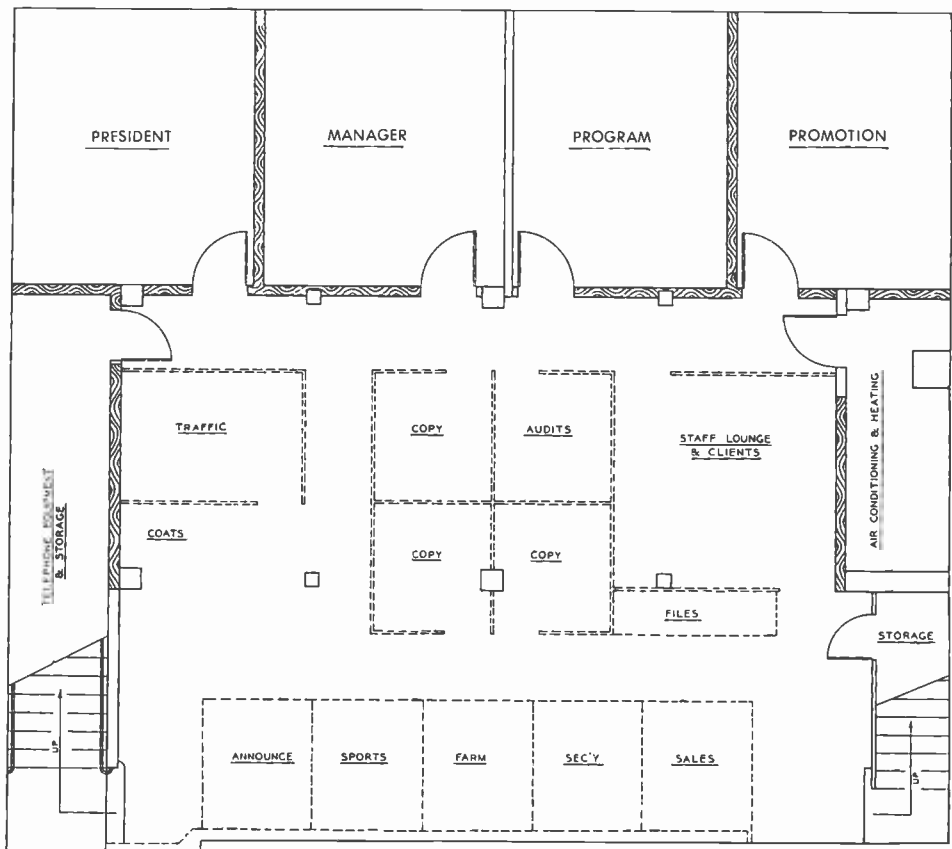

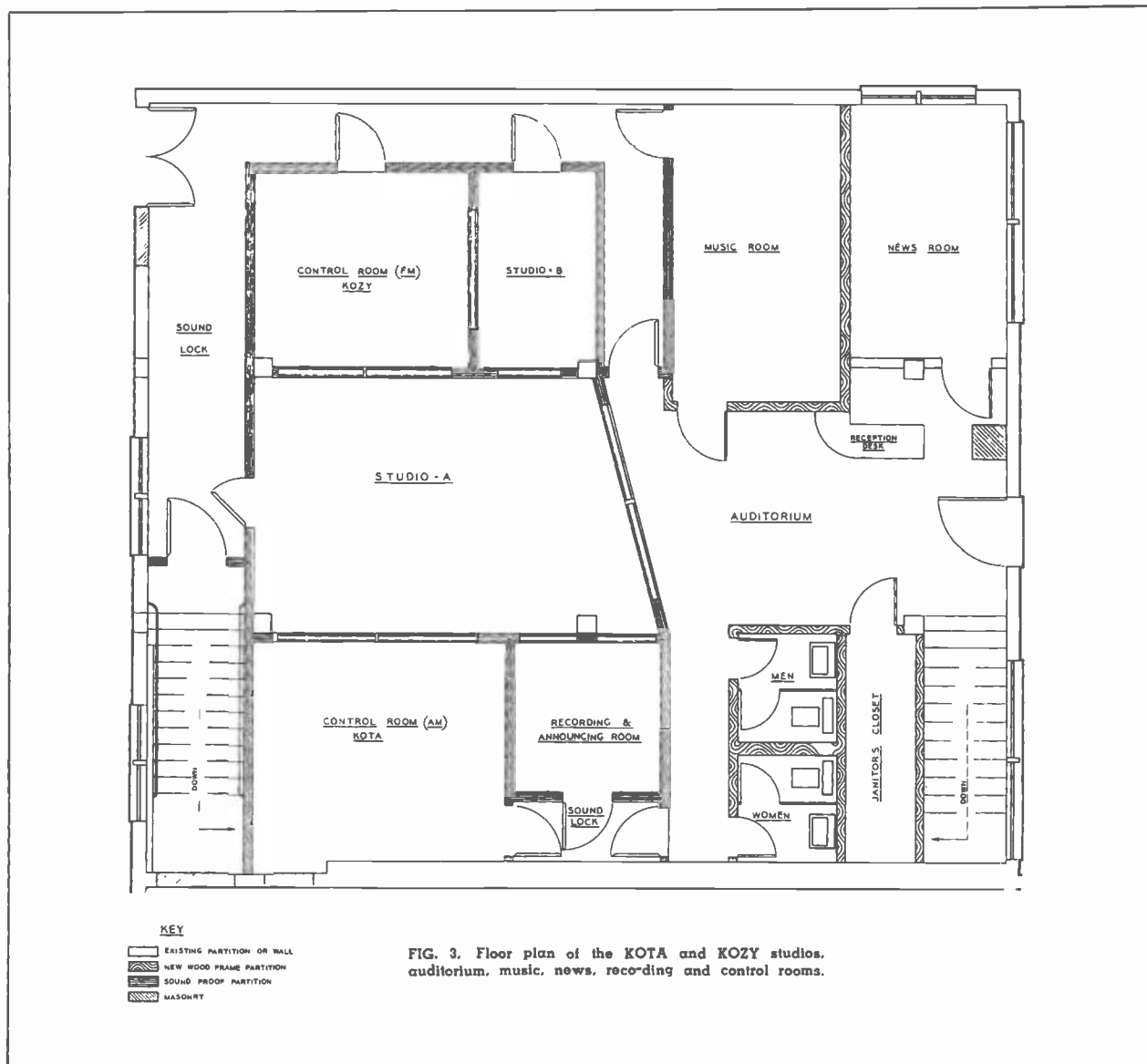

A used transmitter had been purchased to accommodate the use of 5-kw on 1380 kc, at the time of the second power increase, and a new and modern building had been erected to house the equipment. The transmitter site was changed, at that time, to its present location.

Certainly one of the most momentous milestones in KOTA history was the station's affiliation with the Columbia Broadcasting System on January 1, 1945. With Mr. Dean as President, Lorenz Iverson of Pittsburgh as Vice-President, and Leo Petersen as Secretary-Treasurer of the com-

pany, the station's formative years had reached a climax on that New Year's Day.

Buildings

During the first fourteen years of operation. KOTA offices and studios were located in the Alex Johnson Hotel in Rapid City. Year by year expansion continued until two floors were occupied by the Black Hills Broadcast Company, and working conditions were still cramped.

In March of 1951, the company purchased and redecored a two floor building on West St. Joe Street, in Rapid City.

Presently, that building houses the studios and offices of KOTA and KOZY, with studios and offices arranged as Fig. 2 and Fig. 3 illustrate.

Since the stations are programmed without duplication, the studios and announce booths are interconnected so they may be used by either station. Both consoles are dual channelled, so it's possible to feed both stations from either control room in emergencies, for purposes of servicing, etc.

The AM and FM Transmitter buildings are located at points remote from the studios, and a prominent street level display



FIG. 4. Full view of the brick-constructed KOTA-AM transmitter building — located outside Rapid City.

window is still retained in the Alex Johnson Hotel in downtown Rapid City.

The increase in physical properties and working space required for the operation of the two stations is indeed significant of the acceptance of KOTA and KOZY in the area they serve.

KOTA-AM Installation

On March 30, 1948, the company received a construction permit for the installation of a new BTA-5F RCA transmitter and associated equipment at the AM transmitter site.

There are two highly interesting features in this installation history. First, the new BTA-5F transmitter was installed in the exact location of the old transmitter, with-

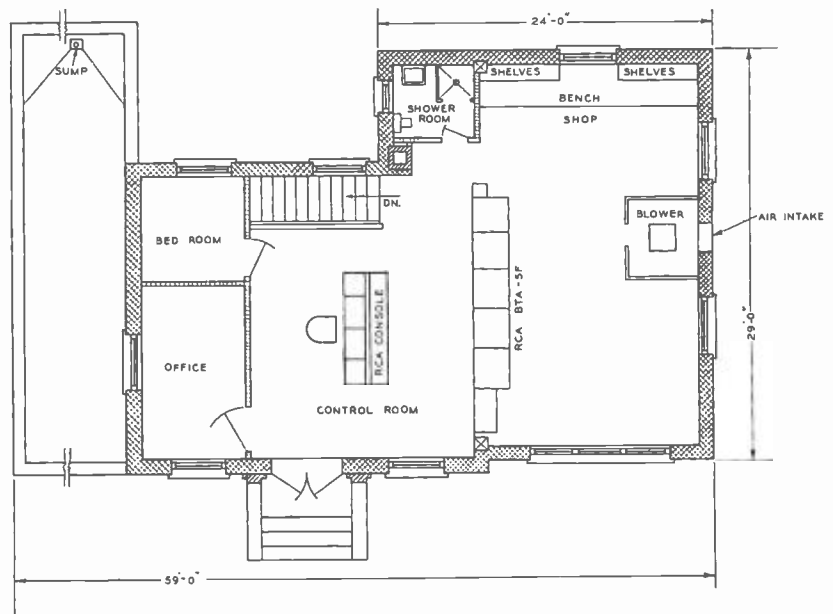

FIG. 5 (at right). Floor plan of the KOTA-AM transmitter plant.

FIG. 6. Front view of the KOTA 5-KW AM Transmitter, RCA BTA-5F, and Companion Supervisory Console.



FIG. 7. Rear view of the AM Transmitter at KOTA showing an unusual space-saving enclosure for high-voltage components which leaves the major portion of the room free for other uses.



out loss of any air time. This was done by assembling the new unit in front of the old one, and making the actual replacement in one night, between sign-off and sign-on. The new unit was rolled back into place on $\frac{3}{8}$ " steel pump rods, immediately after the old equipment was removed. Secondly, the space-saving arrangement in the rear of the new RCA transmitter warrants attention. It's pictured in Fig. 7.

In connection with this installation and to insure the realization of maximum benefits from the new transmitter, we re-equipped the AM studio and control room with RCA Universal Pickups. The installation became RCA all the way!

Because this equipment was extremely satisfactory in every way, a duplicate set of control room equipment was ordered from RCA and installed in the KOZY (FM) control room, which was being readied for use while the FM transmitter building was under construction. Over and above this finest of technical facilities, the control room was wired for separate operation and, from the day KOZY went on the air, there were very few exceptions to the "no duplication of AM" ruling.

The Line 1 console out of the KOTA console, and the Line 2 console out of the KOZY console are connected through a delta-wye bridge so both feed KOTA trans-



FIG. 8. View of a tractor opening the road to KOZY-FM plant atop "Signal Hill".



FIG. 9. View of the Pylon FM Antenna during assembly prior to installation.



FIG. 10. Aerial view of the KOZY Transmitter House (bottom of photo), and the "Skyline Drive" approach.

mitter Line 1; KOZY Line 1 console out and KOTA Line 2 console out both feed the KOZY Line to the KOZY transmitter. This eliminates patching or external switching to feed either or both transmitters from either control room.

It's approximately five years since we installed the BTA-5F transmitter and we're extremely pleased to report that during that time there hasn't been a second lost from our airtime because of trouble with the equipment. We've had the same splendid fortune with the FM transmitter.

KOZY-FM Installation

In November of 1948, we received a green light from the FCC and began constructing our new 16-kw FM station two days later. We cut out of the side of a mountain a site for the transmitter house, which was constructed of poured concrete, being fireproof throughout. We employed Carl Fisher of Portland to construct a 370-foot tower, to be purchased from him and erected on a mountain overlooking Rapid City, at approximately 650 feet above the main street of the city.

We ran into some very difficult digging and blasting problems as a result of our decision to bury the deadmen at three equidistant points, guying all of the lines to these three points, 120 degrees apart. Each of the deadmen are buried in from seven to ten yards of concrete, and this concrete is poured down into solid sandstone. We did this because the high wind that sometimes rolls up over the mountain has been known to reach a velocity of more than ninety miles an hour.

Two weeks after we had started the construction, things really began to freeze. The temperature dropped down to twenty degrees below zero. Tarpaulins and space stoves were used to keep the concrete from freezing and, finally, after it was all cured and set properly, and tested, we began the erection of the tower right after Christmas.

We had three sections up, guyed by ropes, on the night of January 2. These ropes were fastened to nearby pine trees, simply to hold the sections in place until we got the guylines fastened to them. The guylines were fastened ten days later—because on the night of January 2 it happened—the worst blizzard in eighty years! It was the famous "blizzard of '49"!

The snow covered the mountain in drifts fourteen feet high and, of course, it cov-



FIG. 11. View of the KOZY 3-KW FM Transmitter, RCA BTF-3B and Associated Console and Monitoring Racks.

cated atop a 650-foot mountain (approximately 4400 feet above sea level). The CAA blinker lights on the tower can be seen for 100 miles. It is truly a sentinel, marking the hills for miles around. The signal reaches about 120 airline miles with good, strong, static-free strength. Our engineering staff has made a survey of radio sets throughout the hills and it is our estimate that there are approximately 22,000 or more homes equipped with FM in the area.

In October, 1951, the FCC authorized conversion of the BTF-3B RCA transmitter to a BTF-5A. By means of an RCA conversion kit installation, this change increases the effective radiated power from 16-kw to 25-kw for KOZY. This conversion, as well as the original installation of the FM transmitter, was completed entirely by local engineers who followed the comprehensive instructions sheets furnished with the RCA equipment. The services of an RCA Field Engineer were not required, despite the fact that the local engineers were not experienced in working with FM equipment.

ered the streets not only in Rapid City but over a blanket area of several hundred miles, which was referred to in *Time* Magazine as the "white plague area". Rapid City spent tens of thousands of dollars to clear the snow from the streets and, finally, they sent a bulldozer up Skyline Drive to our site, which is called "Signal Hill". The bulldozer made its way up that narrow road and for the first time in many days, we saw that our tower was standing.

A wet fog had apparently covered the mountain and given the guy ropes a good wet drenching, and then they had frozen. As they froze, they contracted and held the tower through the terrific wind (four days of it). Otherwise, the wind could have rocked the tower, snapped the ropes, causing the tower to fall on the buildings.

The RCA 3-kw transmitter was installed in the transmitter house, and all equipment was transported in good shape. Construction of the tower under these adverse weather conditions took nine weeks, just five times as long as it would have taken in the summertime.

The four-bay Pylon is installed on top of a 300-foot tower which, in turn, is lo-

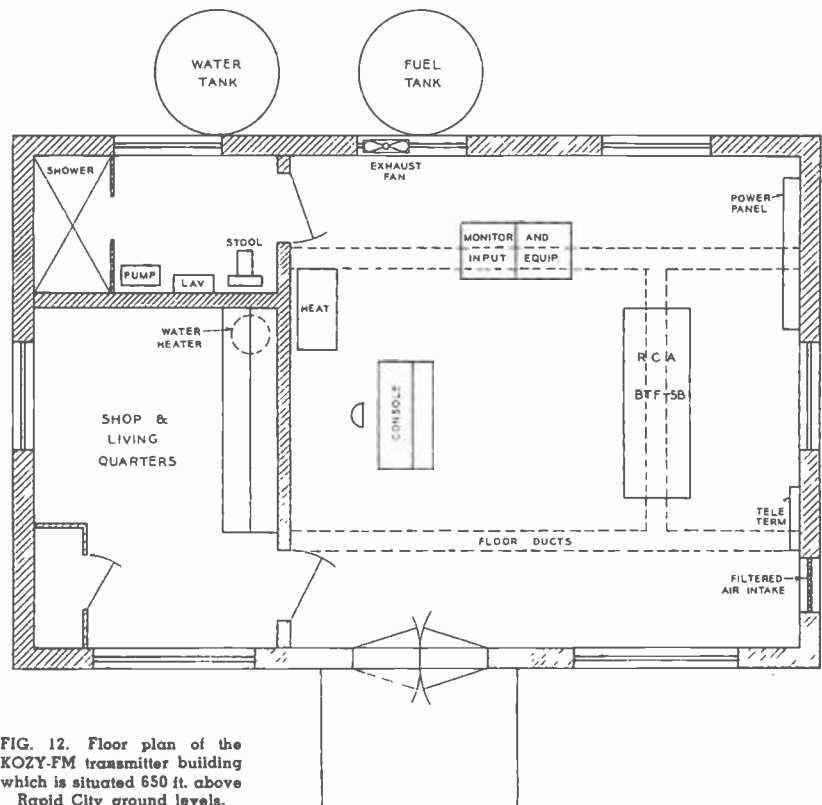

FIG. 12. Floor plan of the KOZY-FM transmitter building which is situated 650 ft. above Rapid City ground levels.

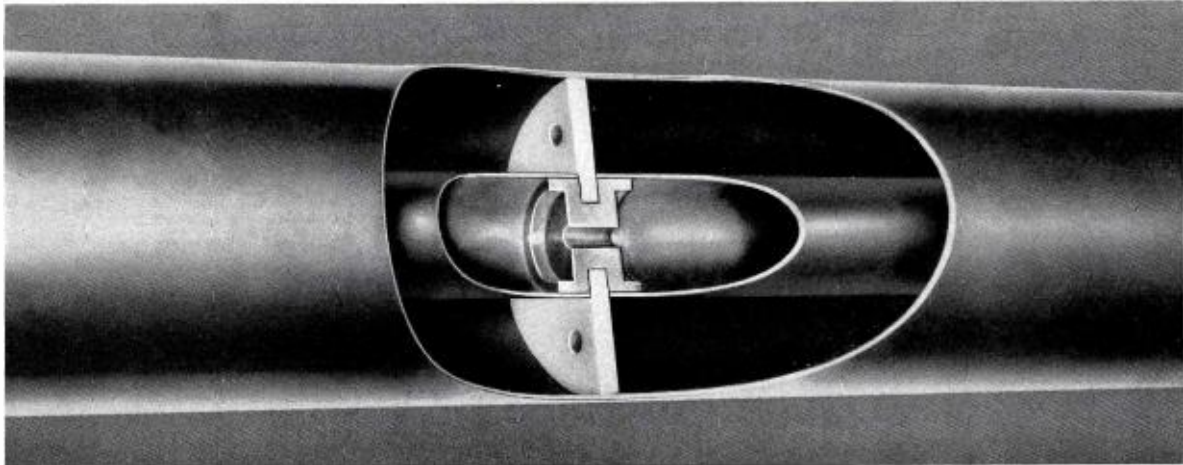

FIG. 1. Photograph of UHF 3 1/8" 50 ohm undercut insulator.

NEW 3 1/8-INCH UHF ULTRA LOW LOSS COAXIAL LINE

By O. O. FIET

RCA Broadcast Transmitter Engineering

RCA has demonstrated coaxial transmission lines for UHF television under actual operating conditions in Washington, D. C. (1948) and again in Bridgeport, Conn., where 250 feet of 3 1/8-inch line has been in use for 2 years.^{1,7} Now a low loss coaxial line (MI-19089) has been developed which fully meets all performance requirements for UHF television.

Low loss qualities are inherent in its design and additional stability is provided by the use of Teflon dielectric components. Attenuation is held to a minimum (as shown in Fig. 3) and power rating is improved as indicated by Fig. 4.

While previous VHF line (RCA MI-19113-1) serves well in the frequency range for which it was designed, RCA MI-19089 UHF Ultra Low Loss Line may be used effectively for radio frequency power transmission at frequencies well below the broadcast band and up to approximately 1000 mc. A "flat" characteristic impedance of 50 ohms is maintained across this wide range of frequencies—by actual measurement as well as theoretically. (See Fig. 2.)

¹ "Ultra-High Frequency Antenna and System for Television Transmission" by O. O. Fiet, RCA REVIEW, June 1950.

⁷ "Notes on a Coaxial Line Bead" by D. W. Peterson, Proc. I.R.E., Vol. 37, No. 11, p. 1294, Nov. 1949.

The following characteristic impedance calculations and graphical data are confirmed by actual measurements of VHF and UHF lines and demonstrate the versatility of MI-19089 Ultra Low Loss Coaxial Line. An accurate evaluation of the characteristics of both VHF and UHF line can

be made on the basis of the data presented in the following pages of this article.

Characteristic Impedance of VHF Coaxial Transmission Line

The characteristic impedance of VHF coaxial lines whose uniform-diameter inner

FIG. 2. Characteristic impedance of RCA 3 1/8" diameter coaxial lines.

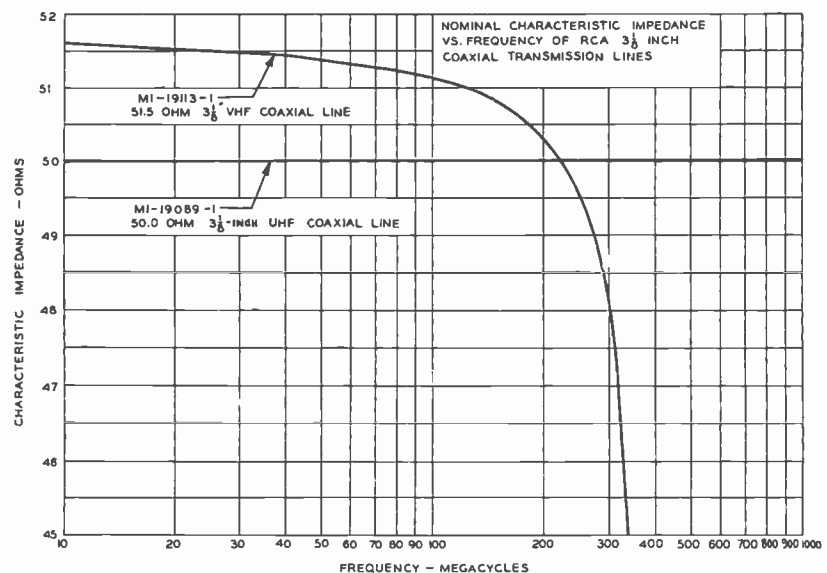

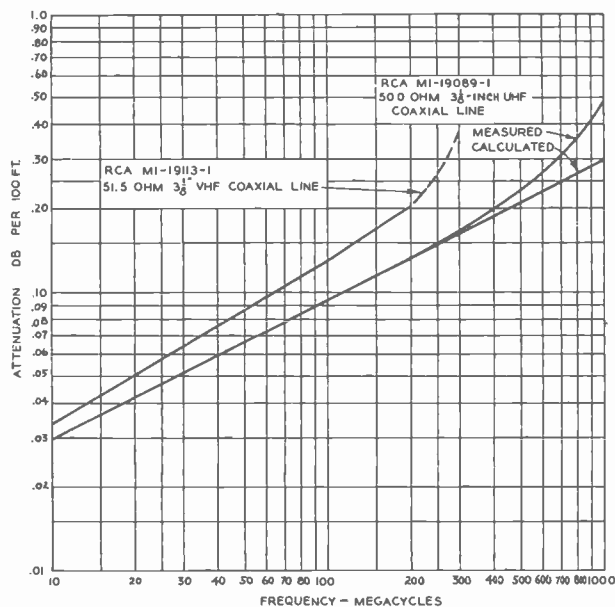

FIG. 3. Attenuation of RCA 3/8" VHF and UHF coaxial lines.

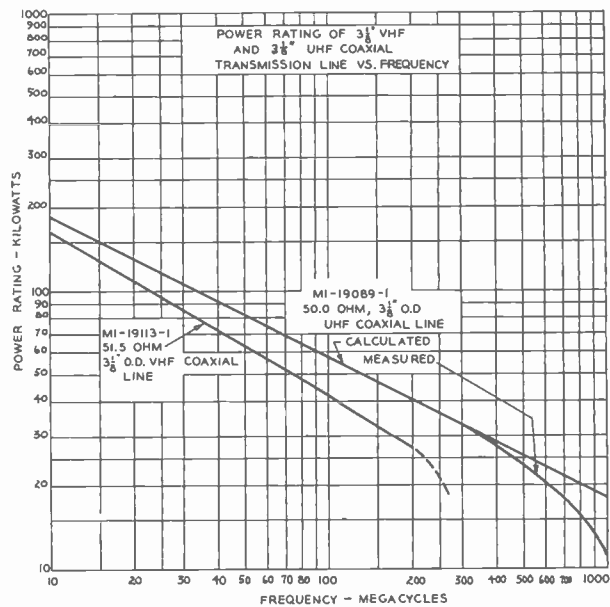

FIG. 4. Power rating of RCA 3/8" VHF and UHF coaxial lines.

conductor is supported by ceramic disks, varies with frequency. A typical characteristic impedance variation with frequency is shown in Fig. 2 for RCA MI-19113-1 VHF coaxial line. This characteristic impedance may be calculated by use of transmission line equations² or graphically using a transmission line chart.⁵

The characteristic impedance of the VHF line may be calculated by transmission line equations as follows:

The characteristic impedance must be calculated on a per section basis since the uniform spaced ceramic insulator disks make the transmission line a periodic network. A section consists of a length of line equal to the insulator spacing with an insulator at its mid-point. In the transmission band, since lossless elements are assumed, the characteristic impedance is real.³ The impedance seen at the mid-point of the insulator is also real.³

The equation for the input admittance Y_s of a uniform lossless transmission line terminated in an admittance Y_r is:

$$Y_s = Y_o \frac{\frac{Y_r}{Y_o} + j \tan \beta l}{1 + j \frac{Y_r}{Y_o} \tan \beta l} \quad \text{Eq. 1}$$

where Y_o = characteristic admittance, β =

$$\text{phase constant} = \frac{2\pi}{\lambda} \text{ radians/unit length}$$

λ = wavelength

l = length of line in same units as λ

The admittance at the center of an insulator including $1/2$ the insulator susceptance

$$\text{is } Y_r = G_2 + j \frac{B_{d1}}{2}$$

where B_{d1} is the additional susceptance introduced by the insulator disk and G_2 is the characteristic admittance of a section at the mid-point of the insulator disk.³

The input admittance $Y_s = G_1$ where $G_1 = Y_o$ the characteristic admittance on the line $1/2$ way between insulators,

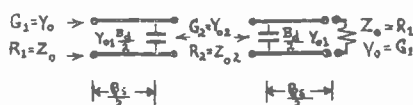

substituting in Eq. 1

$$G_1 = \frac{Y_{o1} \left[\frac{G_2 + j \frac{B_{d1}}{2}}{Y_{o1}} + j \tan \frac{\beta s}{2} \right]}{\left[1 + j \frac{G_2 + j \frac{B_{d1}}{2}}{Y_{o1}} \tan \frac{\beta s}{2} \right]} \quad \text{Eq. 2}$$

by setting the real and imaginary components equal, we obtain two simultaneous equations which may be used to eliminate G_2 ,

$$\text{then } G_1 G_2 = G_1^2 \left(1 - \frac{B_{d1}}{2Y_{o1}} \tan \frac{\beta s}{2} \right) \quad \text{from reals} \quad \text{Eq. 3}$$

$$\left(\frac{G_1 G_2}{Y_{o1}} - Y_{o1} \right) \tan \frac{\beta s}{2} - \frac{B_{d1}}{2} = 0 \quad \text{from imaginaries} \quad \text{Eq. 4}$$

eliminating G_2 from equations 3 and 4 and

$$\text{solving for } G_1 = Y_o \text{ or } \frac{1}{G_1} = Z_o$$

$$Z_o = Z_{o1} \sqrt{\frac{\tan \frac{\beta s}{2} - \frac{B_{d1} Z_{o1}}{2} \tan^2 \frac{\beta s}{2}}{\tan \frac{\beta s}{2} + \frac{B_{d1} Z_{o1}}{2}}} \quad \text{Eq. 5}$$

Cutoff occurs when numerator or denominator is = 0. At the cutoff frequencies

$$\left. \begin{aligned} \tan \frac{\beta s}{2} &= 0 \\ \tan \frac{\beta s}{2} &= \frac{2}{B_{d1} Z_{o1}} \\ \tan \frac{\beta s}{2} &= -\frac{B_{d1} Z_{o1}}{2} \end{aligned} \right\} \quad \text{Eq. 6}$$

Calculating numerical constants and substituting in equation 5, we obtain the characteristic impedance of a uniformly spaced dielectric-disk insulated line.

² "Radio Engineers Handbook" by Terman, First Edition, pp. 172 to 251.
³ "Transmission Networks and Wave Filters" by Shea, eqs. 46, 47, p. 192.
⁵ "Transmission Line Calculator" by P. H. Smith, Electronics, Jan. 1944, p. 130.

$$Z_{01} = Z_{01} \sqrt{\frac{\tan(.01526 sf_{mc})^\circ - .266 f_{mc} t (\epsilon_d - 1) \tan^2(.01526 sf_{mc})^\circ}{\tan(.01526 sf_{mc})^\circ + .266 t (\epsilon_d - 1) f_{mc}}} \quad \text{Eq. 7}$$

The superscript ° indicates electrical degrees, 360° per turn.

$$\text{where } \frac{Z_{01} B_d}{2} = \frac{.532 t f_{mc} (\epsilon - 1)}{2} = .266 f_{mc} t (\epsilon_d - 1) \quad \text{Eq. 8}$$

and $Z_{01} = 138 \log_{10} D/d$

The notation used is as shown in Fig. 6. All dimensions are in inches.

Equation 7 is sufficiently simple to permit calculation of Z_0 by slide rule. The solution obtained is the same as obtained by the graphical solution which follows. Equation 7 represents a great simplification of previously published results.⁴

The graphical calculation of characteristic impedance uses the principle of the characteristic impedances being real as stated above. Use of the expanded center portion of the Smith Chart⁵ as shown in Fig. 5 illustrates a very convenient solution for characteristic impedance.^{4,5}

Characteristic Impedance of UHF Coaxial Transmission Line

The effect of the support insulator of the MI-19089-1 line on the characteristic impedance of the line is eliminated by using an insulator support system having a characteristic impedance equal to the air dielectric portion of the line over the useful operating frequency range. Such an insulator is said to be transparent.^{1, 8, 7}

A straight undercut insulator,⁶ shown in Figs. 1 and 7, is a suitable transparent insulator which is mechanically simple. The undercut portion of the inner conductor has a characteristic impedance Z'_0 slightly greater than the air dielectric portion of the coaxial line to compensate for the step capacity,^{8, 9, 10} C_d , of the sides of the undercut. Thus, the undercut insulator, including the effect of the step capacity, can be developed to have a characteristic impedance very nearly equal to that of the air dielectric portion of the coaxial line.⁶

The design of the undercut may be established by the use of the transmission line admittance, equation 1, as follows:

¹ Loc. cit.

⁴ "Design Data for Beaded Coaxial Lines" by C. R. Cox, Electronics, May 1946, pp. 130 to 135.

⁵ Loc. cit.

⁶ "A Coaxial Line Support for 0-4000 MC" by R. W. Cornes, Proc. I.R.E., Vol. 37, No. 1, p. 94, Jan. 1949.

⁷ Loc. cit.

Referring to the notation used in Fig. 7 for this case,

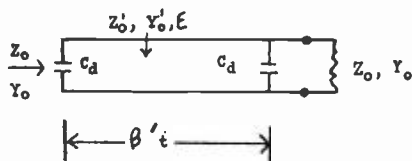

$$Y_r = Y_0 + j\omega C_d \quad \text{Eq. 9}$$

$$Y_{in} = Y_0 = Y_r + j\omega C_d \quad \text{Eq. 10}$$

Substituting equations 9 and 10 in equation 1,

$$Y_0 = Y'_0 \left(\frac{Y_0 + j\omega C_d}{Y'_0} + j \tan \beta' t \right) + j\omega C_d \quad \text{Eq. 11}$$

By separating the equation into real and imaginary parts and setting the real parts equal, we obtain:

$$Y_0 = \sqrt{2\omega C_d Y'_0 \cot \beta' t - \omega^2 C_d^2 + Y_0'^2} \quad \text{Eq. 12}$$

$$Z_0 = \frac{Z'_0}{\sqrt{1 + 2\omega C_d Z'_0 \cot \beta' t - \omega^2 C_d^2 Z_0'^2}}$$

Where referring to Fig. 7, all dimensions are in inches.

$$Z'_0 = \frac{138}{\sqrt{\epsilon_d}} \log_{10} D/d_1$$

$$Z_0 = 138 \log_{10} D/d_2$$

$$\beta' t = \frac{2\pi}{\lambda} t \sqrt{\epsilon} = \frac{f_{mc} \sqrt{\epsilon} t 2\pi \text{ radians}}{11800}$$

$$\beta' t = \frac{360^\circ f_{mc} \sqrt{\epsilon} t}{11800} = .0305 \sqrt{\epsilon} f_{mc} t \text{ degrees}$$

and

$$C_d = f(d_1, d_2, D, t, \epsilon)$$

The value of C_d is most readily calculated from published data.^{9, 10} Because of the mutual proximity effects of the two steps, reference 8 cannot be used for great accuracy.

Placing numerical constants in equation 12, we obtain:

$$Z_0 = \frac{Z'_0}{\sqrt{1 + 1.25 \times 10^{-5} f_{mc} C_d Z'_0 \cot(.0305 \sqrt{\epsilon} f_{mc} t) - (2\pi f_{mc} 10^{-6} C_d Z'_0)^2}} \quad \text{Eq. 13}$$

for C_d in $\mu\mu\text{fd}$.
t in inches
 ϵ relative to vacuum

Equation 13 is the equation of the characteristic impedance of an undercut support insulator. Actual dimensions are established by use of equation 13, and successive measurements of many beads spaced $\lambda/2$ until a near-perfect undercut design is established. Figure 8 shows the performance of a sample line using support insulators developed by this method.

Principle of UHF Transmission Line Support Insulator

The support insulator used for UHF is a so-called electrically-transparent insulator; that is, it introduces no discontinuity or "bump" which must be made non-critical by using similar insulators spaced less than a quarter wavelength. The older type VHF transmission line depended upon insulators spaced a small portion of a wavelength to obtain satisfactory performance. Obviously, for the short wavelengths used in UHF television, such an approach is not economical or practical. The UHF line with transparent insulators does not have a characteristic standing wave pattern between insulators as exists in the older VHF transmission lines when properly terminated (see Fig. 6). Consequently, the UHF line may be cut without regard to insulator location without changing the operating impedance. Of course, the UHF line should not be cut so near the undercut insulator (see Figs. 1 and 7) that the length of inner conductor tube remaining on the end is insufficient for the standard inner conductor connector, or at a point through the insulator support which would destroy its electrically-transparent character.

Type of Connecting Terminals

Connecting terminals are in accordance with proposed RTMA connector standards for $3\frac{1}{8}$ " O.D., 50 ohm air dielectric coaxial line. Centering provisions are provided to prevent the misalignment of outer conductors which would cause undesirable step capacity (as illustrated in Fig. 7).^{8, 9, 10}

⁸ "Coaxial Line Discontinuities" by Whimery et al, Proc. I.R.E., Nov. 1944, pp. 695 to 709.

⁹ "Equivalent Circuits for Discontinuities in Transmission Lines", Proc. I.R.E., vol. 32, pp. 98-115, Feb. 1944.

¹⁰ "Handbook of Design Data", Brooklyn Polytechnic Institute, Report No. R-158-47.

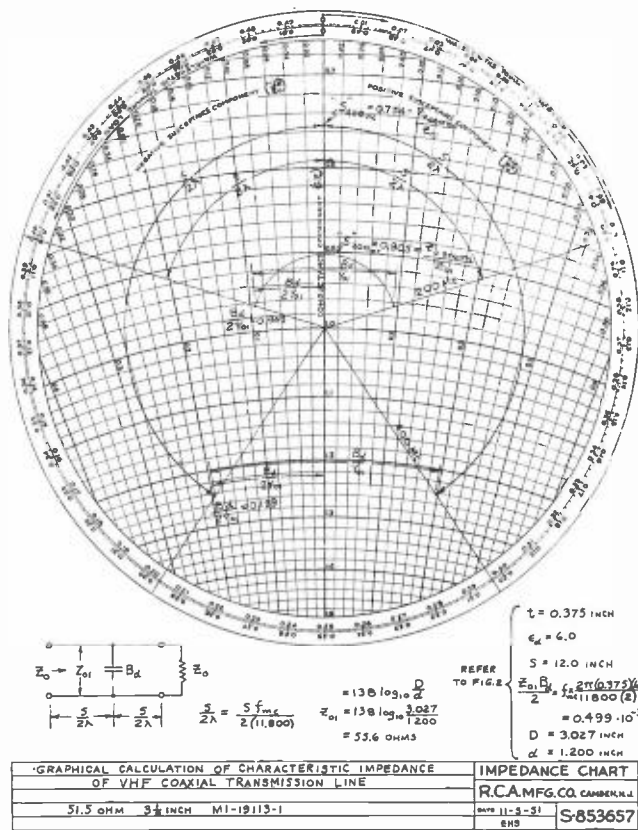

FIG. 5. MI-19113-1 VHF coaxial line graphical characteristic impedance calculations at 200 mc and 400 mc.

Typical Standing Wave Characteristic in UHF Band

The standing wave characteristic (see Fig. 8) was measured on a sample run of UHF line. The results obtained will assure very satisfactory performance. However, recent developments which will be incorporated in the commercial line indicate that performance in many cases will be better than that shown in Fig. 8. The residual standing wave characteristic of this line for VHF television is very low and represents a great improvement when compared with earlier VHF coaxial lines.

Attenuation and Efficiency

The efficiency of RCA UHF transmission line is shown in Fig. 9. It should be noted that the efficiency figures are based on measurements by RCA engineers. These efficiency values are somewhat lower than would be obtained by the usual theoretical calculations. Surface roughness, higher order modes at insulators and higher than theoretical dielectric losses may add to the usual calculated attenuation values obtained at UHF by considering only copper and theoretical dielectric losses. It would

be misleading to publish purely theoretical attenuation figures omitting comparison with experimental data. Such information would not be indicative of actual performance. Consequently, Fig. 3 gives a comparison of measured and calculated attenuation for RCA MI-19089-1 coaxial line.

Power Rating

The power rating of MI-19089-1 3/4" UHF line is 57.5 KW at 100 mcs and varies approximately inversely as the square root of frequency (as shown in Fig. 4); consequently, the 3/4" UHF line is capable of handling more than 10 KW of UHF power over the entire UHF band. The power rating established for the MI-19089-1 UHF line is based on the measured attenuation shown in Fig. 3. The power rating is selected to obtain a constant maximum heat dissipation per foot, independent of operating frequency.

Mechanical Characteristics

The mechanical characteristics and durability of the UHF line are comparable in all respects to the transmission line which has been previously used for VHF.

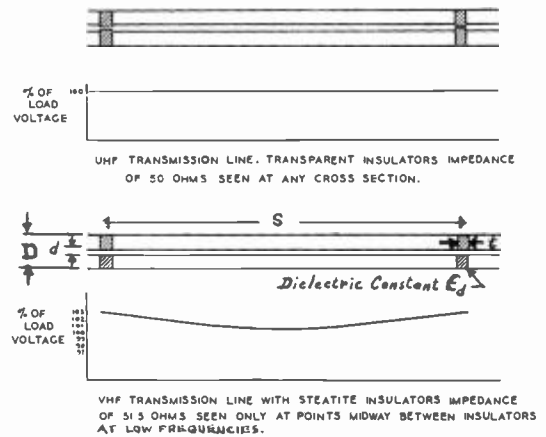

FIG. 6. Voltage distribution on UHF and VHF transmission lines.

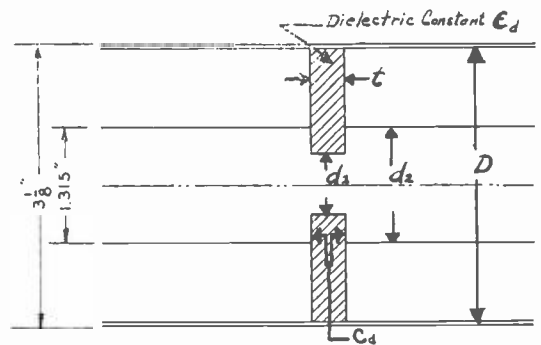

FIG. 7. Cross section of undercut insulator.

Construction

The construction of the UHF transmission line is similar to the coaxial line familiar to the broadcast engineer for VHF television application. Particular attention is given to connectors to assure that no "bump" is introduced. Centering pins are located on the outer conductor connector (see Fig. 10) to prevent a "bump" due to "step" capacity which would be caused by a poorly centered outer conductor connection.^{8,9,10}

Teflon dielectric has some peculiar mechanical characteristics which must be carefully considered in the design of an adequate trouble-free Teflon anchor insulator. The rolled groove in the outer conductor, previously used to support the older type of ceramic disk anchor insulator, is not adequate mechanically or electrically at UHF. The commercial introduction of the RCA MI-19089 TV coaxial line was not announced until the performance of a suitable anchor insulator, similar to the one used in the MI-19089 coaxial line was proven by nearly two years of continuous trouble-free service in the RCA/NBC ex-

^{8,9,10} *Loc. cit.*

perimental UHF TV station at Bridgeport, Conn. *It is not necessary to alternate anchor insulator positions on horizontal runs of MI-19089-1 coaxial line to prevent "walking".*

Fig. 10 shows the construction of a typical UHF 90° miter elbow. Excellent performance characteristics are obtained from DC to 1000 mc by use of a special inner conductor construction. Similar 45° bevel elbows will not be used in the standard RCA UHF transmission line since the more compact miter elbows are electrically superior and more adaptable to varied installation requirements.

Application and Installation

Methods of installation for the UHF line are the same as for VHF line. The same mounting hardware is used to install UHF 3 7/8" line as for VHF 3 7/8" line. However, only one line is necessary to feed the RCA TFU-24-B UHF antenna. A spare line may, of course, be installed if desired. Dents in the line may cause severe impedance disturbances and ghosts in UHF television. One should not conclude on the basis of previous VHF experience that denting can be disregarded.

It is well known that the transmission line system must be kept pressure-tight and that neglected gas leaks may cause system failures. Dry nitrogen is preferable to dry air, because a malfunctioning dehydrator may permit entrance of impurities such as sulphur dioxide, hydrogen sulphide, sulphur trioxide, nitric oxide, ozone, ammonia, carbon dioxide or water vapor. Any of these substances, if present over an extended period of time, even in minute amounts with water vapor, will cause corrosion and insulator leaks. Increased attenuation and eventual power failure may result.

Because of the consequences caused by the introduction of gaseous impurities which are detrimental in the presence of water vapor, station maintenance personnel should be sure the air dehydrator, if used, is in excellent condition at all times, of adequate capacity and that gas leaks in the system are located and promptly repaired.

If the pressure gauge on the output of the nitrogen tank regulator decreases in pressure reading when the nitrogen supply is turned off for a period of 12 to 24 hours, except for small variations due to atmospheric temperature and pressure changes,

¹ Loc. cit.

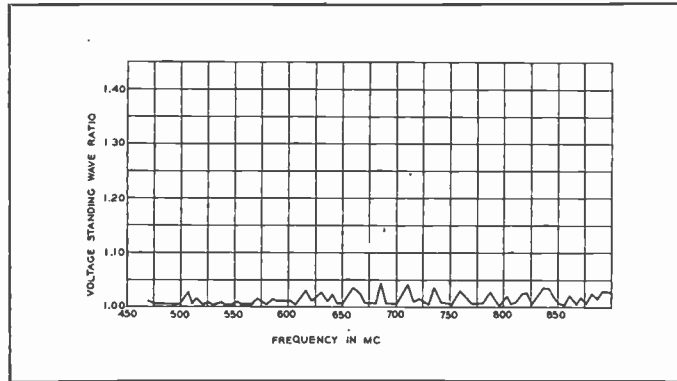

FIG. 8. Typical measured UHF standing wave ratio for RCA MI-19089-1 UHF transmission line.

all flange joints and solder joints should be carefully tested using a soap bubble solution. The use of nitrogen tanks for pressurizing coaxial line can become quite expensive if bad leaks exist, therefore maintenance personnel should repair bad leaks at the first opportunity.

Low Loss High Power Transmission Lines for UHF

RCA has developed and published data on low-loss super power wave guide (up to 500 KW input) suitable for UHF television.¹ A suitable 6 1/8" diameter coaxial line is also under development. The results of tests on the 6 1/8" UHF coaxial line are encouraging and performance data should be available soon.

Larger low-loss transmission lines are more expensive to use and install and may

require more expensive supporting structures. The larger size waveguides and transmission lines are more critical in application and installation and consequently will be introduced for commercial UHF television use after the effectiveness is established through exhaustive field tests being made by RCA antenna engineers.

Features of MI-19089 3 7/8" UHF Coaxial Line

GREATLY REDUCED LOSSES

71.4% of MI-19113-1 Coaxial Line at 200 mc. See Figs. 3 and 9.

GREATER POWER INPUT RATING

Because of the greatly reduced losses, see Figs. 9 and 3. The power input rating is greater than for the VHF line. (See Fig. 4.)

CONSTANT CHARACTERISTIC IMPEDANCE

The nominal characteristic impedance does not vary with frequency in the operating range. See Fig. 2.

May be cut anywhere between insulators without affecting impedance. No special diameter inner conductors are required if line is cut. See Figs. 1 and 6.

UHF OR VHF OPERATION

This line may be used to advantage by VHF-TV stations since it serves equally well at either VHF or UHF.

In the event all TV goes to UHF, the station may use this line for a new UHF installation. The greater efficiency and power rating of the MI-19089 UHF coaxial line offset the slightly higher initial cost and make it desirable for VHF application.

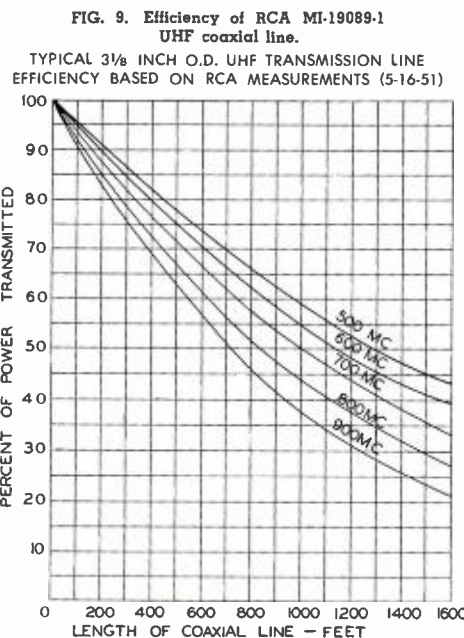
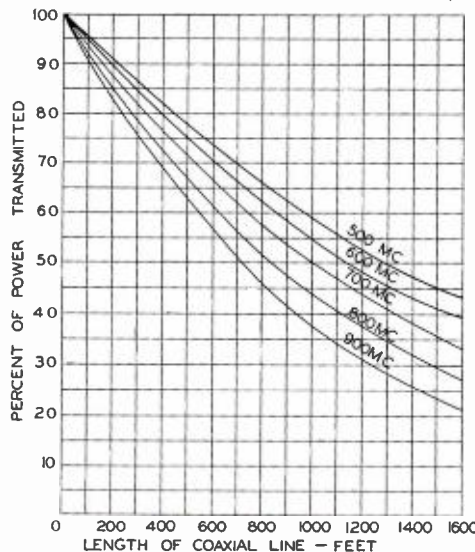

FIG. 9. Efficiency of RCA MI-19089-1 UHF coaxial line.

TYPICAL 3 7/8 INCH O.D. UHF TRANSMISSION LINE EFFICIENCY BASED ON RCA MEASUREMENTS (5-16-51)



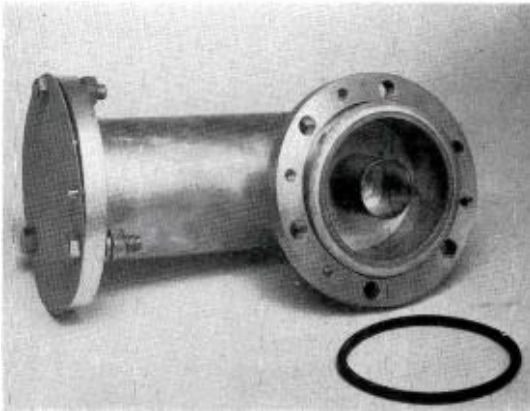

FIG. 10. MI-19089-2 UHF mitered elbow.

TYPICAL INSTALLATION OF UHF TRANSMISSION LINE ON TOWER—SINGLE LINE IS USED FOR TFU-24-B ANTENNA

(REFER TO TABLE BELOW FOR SYMBOL DESIGNATIONS)

SYMBOL DESIGNATIONS

Symbol	Description	3 1/8" Dia. MI No.
A	TRANSMISSION LINE	19089-1
B	90° MITER ELBOW	19089-2
C	NOT REQUIRED	—
D	GAS STOP	19089-4
E	NOT REQUIRED	—
F	45° BEVELED ELBOW	19089-3
G	COPPER TUBING	19315-1
H	ELBOW FITTING	19315-2
J	NIPPLE	19315-9
K	TEE FITTING	19315-13
M	PRESSURE GAUGE	19315-14
N	FIXED HANGER	See Note 2
P	SPRING HANGER	See Note 1
R	LATERAL BRACE	19313-36
S	HORIZONTAL ANCHOR	19313-17
T	ROLLER ASSEMBLY	19313-35
U	SWIVEL HANGER	19313-37
V	NITROGEN TANK—Available locally	—
W	PRESSURE REGULATOR	19315-19

NOTE 1—For 3 1/8" line use MI-19313-20 through MI-19313-44.

NOTE 2—For 3 1/8" line use MI-19313-40 through MI-19313-44.

WHEN SHAPE OF TOWER CHANGES ADD HANGER SUPPORTS TO TOWER THE FOLLOWING BENDS ARE MAX. 6" BEND FOR 20 SECTION 3 1/8" LINE

TO ANTENNA

UPPER TWO HANGERS ARE FIXED TYPE

SPACE SPRING HANGERS APPROX. 10 FEET APART

VIEW OF S

VIEW OF U

VIEW OF T

VIEW OF R

ALLOW SEVERAL FEET FROM ELBOW TO HANGER FOR EXPANSION OF LINE

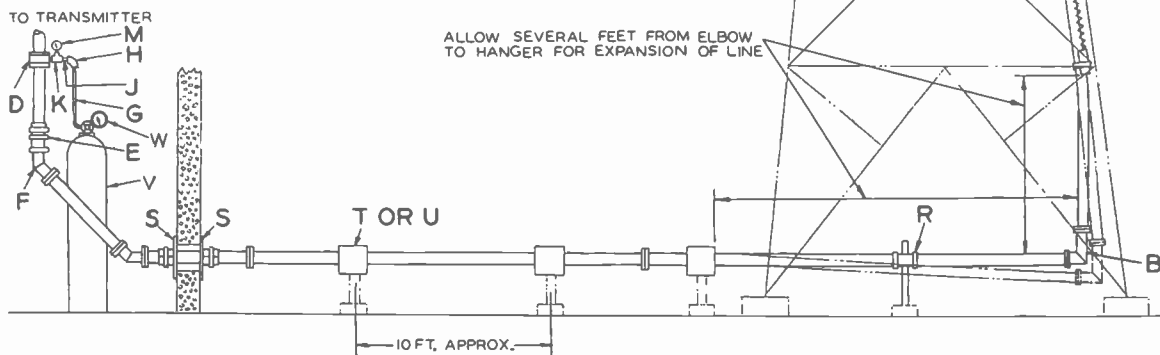

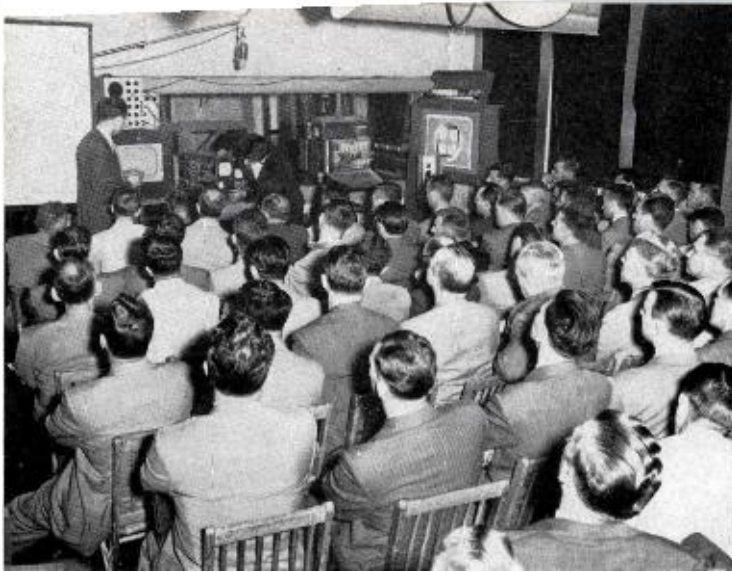

View of complete "Mis-alignment" and re-alignment of TV camera, performed by RCA engineers first—then by TV broadcasters. Complete "practice" procedure required less than 15 minutes.



J. Roe, RCA Television Engineer, describing new TC-4A Audio/Video Console which makes possible simultaneous switching. Unit is used to form part of RCA's "Basic Buy" Package for Television.

THE "Eighth" BROADCASTERS' TV TRAINING PROGRAM

By E. C. MASON and W. R. COULTER

During September, the RCA Engineering Products Department presented its "Eighth" Television Technical Training Program to more than 80 broadcasters, plus Signal Corps and Airforce Personnel.

Considered the most successful TV training program yet conducted, the week-long session was held in the RCA Exhibition Room in Camden. Space was divided into three sections: a lecture room, an exhibit or display area, and a luncheon section where posters depicted "A Typical RCA TV Camera System", "A 1-KW UHF Coaxial Cavity Circuit", "VHF and UHF Transmitters", "Cross-sectional Views of VHF High-band and Low-band Amplifiers" and an enlightening cutaway view of the RCA "Starmaker" microphone.

A center of attraction in the exhibit section was a showcase display of the scale-model replica of RCA's "Basic Buy" TV Package, which provides the necessary equipment to start television operation with minimum investment. A model TV camera, a broadcast turntable, a professional tape recorder and a professional disc recorder were other display pieces which made the broadcasters feel "right at home".

The first day-and-a-half was devoted to Video theory and Video equipment, such as studio cameras, dollies, and special effects units. Then followed discussions of

tube characteristics and the requirements of TV lighting, and a tour of the Engineering Labs. The next phase of instruction covered audio requirements for TV, and the methods by which the desired results could best be obtained. The final lectures concerned antennas and the RCA Service Company.

Judging from the comments of the broadcasters themselves, the overall course gave them the latest word in their field, and was outstanding for two reasons. First, the forty RCA and Broadcast Engineers who served as instructors during the week were thoroughly conversant with their subjects, and supplied the answers to operating problems which arose in the broadcasters' minds. Second, the RCA Television Training Manual, which contains the most up-to-date information on "Television Equipment, Theory and Operation", was given to each person attending the course. This complete and authoritative edition of 450 pages made it possible for the station engineers to take home with them a storehouse of technical television data. The manual pages are divided with tabbed index sheets to properly group data on Transmitters, Antennas, Video, and Audio. To say that the recipients of the manual were pleased is putting it mildly! Never before had there been published so comprehensive a text on Television Equipment, Theory and Operation—a "must" as an engineering reference.

Before the time scheduled for the Training Program to begin, many greetings had been exchanged between broadcasters and many new acquaintances were made among the group of registrants. A breakfast snack was served daily at 8.30 a.m. as a foundation for the training session curriculum which began each morning at 9.00 a.m.

MONDAY'S SESSION

Monday's program began with general announcements and introductions made by E. T. Griffith and H. Duszak. Topics covered in the Monday training program were as follows: "What's Ahead in TV"—by T. A. Smith; "Television Theory"—J. H. Roe and A. H. Lind; "TV Camera Equipment"—J. H. Roe; "Flying Spot Equipment"—W. E. Tucker; "Synchronizing Generator"—R. J. Smith; "TV Switching"—L. E. Anderson; "Film Projectors"—A. E. Jackson; "Video Amplifiers"—R. L. Hucaby; "Video Monitors"—N. P. Kellaway; "Genlock and Special Effects"—E. M. Gore.

Each lecture topic was concluded with a general question-and-answer session during which time the broadcasters' questions on the subject were answered by the lecturer, or engineers who may have participated in the construction of some particular type of equipment.

A fifteen minute recess—with refreshments—provided relaxation at both the



Group of early arrivals at opening session—(l. to r.): D. Winn, KARK; J. Deaderick, WMPS; P. Baldwin, WHDH; E. T. Griffith, RCA; John Adams, KFDX; H. Sturm, WHTN; J. H. Roe, RCA; W. H. Torrey, KGNC; E. P. Talbott, KROD; W. E. Dixon, WCHS; H. Garba, WASK; G. Zaharis, WTIP; D. Newborg, RCA; R. J. Anderson, WDSU; W. D. Wenger, RCA; E. Hull, WHLD.



(L. to r.): Dr. Roy K. Marshall, with Vic Barry, NBC Engineer and T. Wright, staff of A. E. Cullum, Jr., Consultants, viewing the control console at the Bridgeport UHF transmitter.

morning and afternoon training sessions. Noon luncheons were also provided where each broadcaster could enjoy a super snack and congenial chats with fellow broadcasters. High-fidelity luncheon music was provided by the RCA RT-11A Professional Tape Recorder and LC-1A loudspeaker which served as an operating equipment display.

During the Monday morning recess, each broadcaster was presented with the Television Training Manual, embodying everything from basic TV training material to new engineering data and special TV studio practices and trends.

The 5-day technical training portion of the program was divided into a series of 35 "slide-illustrated" lectures, each lecture essentially a topic extracted from the TRAINING MANUAL.

TUESDAY'S SESSION

Tuesday's discussion (September 11) included lectures on "Microwave Relay Equipment" by C. A. Rosencrans; "TV Mobile and Supplementary Equipment"—L. E. Anderson; "TV Systems"—J. H. Roe; "Test Equipment"—J. A. Bauer; "TV Studio Lighting"—H. M. Gurin (NBC); "TV Pickup Tubes"—R. Johnson (RCA Tube Division, Harrison).

Tour of Engineering Labs

One of the highlights of the Tuesday session was a tour conducted through the

RCA Television Engineering Laboratories. For practical indoctrination into the art of TV broadcasting, the session in the Engineering Laboratories was invaluable. Broadcast engineers were shown how to adjust the image orthicon tube for best shading and vertical and horizontal alignment of the picture image. After the laboratory engineers demonstrated the procedure, one of the broadcasters was invited to duplicate the entire process step by step. "Special effects" such as wipes, flip flops, and masking devices showed the versatility of modern television program effects. Operation of the Genlock and the TC-4A Television Console for transmitters was demonstrated in the control room.

Microwave relay systems including the dish and button-hook antenna were shown and described. A complete "in-operation" set-up of film projection equipment including the RCA TP-9A Television Film Multiplexer was demonstrated.

The final event of the tour was an actual demonstration of the RCA TP-10A Portable TV Film Projector which is equipped with a light shield and linkage mechanism to provide coupling between a 16-mm projector and the lens barrel of a television camera. This equipment enables a remote television crew to use film commercials or other film inserts of short duration at the point of program origin without the need for transmitter switching. As an auxiliary

Lecture room where TV training sessions were held. D. Bain, Manager, Broadcast Audio Equipment is shown addressing assemblage.



Lt. Col. M. E. Williamson, U. S. Air Force; A. R. Hopkins (left) and L. A. Connelly of RCA view RT-11A Professional Tape Recorder during recess period between lectures.





Where TV broadcasters met for luncheons during week-long training sessions at RCA, Camden.

to film studio equipment facilities, the TP 10-A can double as a stand-by film projector.

WEDNESDAY'S SESSION "UHF" Trip to Bridgeport

On Wednesday the entire group enjoyed a day-long excursion to the Bridgeport UHF transmitter built and operated as part of the RCA-NBC UHF development program. Special railroad cars transported the entire group to Bridgeport, Connecticut, where the day's activities began with dinner at the Hotel Barnum. The honored speakers of the day were Wayne Coy, Chairman of the FCC, and Frank M. Folsom, President of the Radio Corporation of America. Other speakers on the program were W. W. Watts, Vice-President and Manager of Engineering Products; T. A. Smith, Assistant Manager of Engineering Products; and Dr. Charles B. Jolliffe, Technical Director of RCA.

A brief introductory talk on the UHF transmitter at Bridgeport was given by Raymond Guy, Engineer in Charge of the Project. A demonstration was given for the broadcasters of the actual results obtained by the microwave relay and the conversion of the NBC signal from New York to UHF frequencies of 530 and 850 megacycles as compared with the direct VHF reception.

UHF receiving antennas that have been developed for home use were shown in operation. Some antennas were "bow-ties" for use on top of receivers. Others were "roof" antennas.

By rapid bus transport with police escort, the guests were whisked to the transmitter location at the city's edge.

The guests were able to make an extensive tour through the transmitter building to observe the operation and construction principles of the UHF transmitters for both 530 and 850 megacycles. Although the transmitter is not a prototype of the commercial model, the UHF antenna is essentially the form proposed for commercial installations.

Although the Bridgeport transmitter was built only for experimental purposes, all the television receiver manufacturers have been invited to test their home instruments and establish standards of UHF reception for their lines. Many companies have tested their experimental models with field intensity equipment, and thus determined the design requirements which must be satisfied in their receivers.

THURSDAY'S SESSION

At the Thursday, September 12 training session, introductions were made by D. Bain and R. J. Newman with the following topics being covered: "Audio Systems for TV" by W. E. Stewart; "Custom Audio for TV"—H. J. Lavery; "Microphone and Microphone Technique"—Mr. Graham (NBC); "Principles of TV Transmitter Design"—T. Gluyas; "TT-2AL/2AH 2-KW TV Transmitter"—W. T. Douglas; "TT-10AL/10AH 10-KW TV Transmitter"—R. Meisenheimer; "TT-25AL/20AH 25 and 20-KW TV Amplifiers"—F. Talmage.

A big "plus" in terms of the course's effectiveness for prospective television en-

gineers was afforded by the nightly tours of local TV stations in the Philadelphia area. Layout of the studios and control rooms were of prime interest. Special effects and related equipment received a big share of the visitors' attention. Construction of scenery, process screen projection, variable lighting facilities, and extended stage runways for audience participation shows evoked many questions, too.

FRIDAY'S SESSION

The final session (Friday, September 14) included the following subjects: "TTU-IB and TTU-10A 1 KW and 10 KW UHF Transmitter" by T. P. Tissot; "Monitoring and Test Equipment"—W. T. Douglas; "General Principle and Theory of TV Antennas"—W. Darling; "TV Antenna Components"—L. Wolf; "TV Super Turnstile Antenna"—H. Wescott; "VHF Custom Antenna"—L. Wolf; "UHF Antenna System Equipment"—O. Fiet; "TV Towers"—D. Balmer; "Installations and Tune-Up of TV Transmitting Equipment"—T. Griffin.

At the close of the Friday training session, each registrant attending the "Eighth" Television Technical Training Program received a certificate to acknowledge his splendid interest in the week-long course.

The broadcasters, a little "worn", had these gratifying comments to make: "Long time since we've attended a meeting with as much interest as this!", "Sure was done up in fine style!", "Looks like UHF will get us TV!", "As host, RCA was tops!", "See you at NAB!"

REGISTRANTS AT THE 8TH TELEVISION TRAINING PROGRAM

CAPT. J. L. ABBELS	U. S. SIGNAL CORPS	FT. MONMOUTH, N. J.	T. McFERRIN	WCBI	COLUMBUS, MISS.
JOHN ADAMS	KFDX	WICHITA FALLS, TEX.	J. MCGOLDRICK	WQAN	SCRANTON, PA.
R. J. ANDERSON	WDSU	NEW ORLEANS, LA.	K. MEALEY	KRFE	FRESNO, CALIF.
P. BALDWIN	WHDD	BOSTON, MASS.	R. MINTON	WBIC	INDIANAPOLIS, IND.
GEORGE BARTLETT	WDNC	DURHAM, N. C.	H. NEWBY	KAKE	WICHITA, KANS.
FATUER BEEMSTER	WBAY	GREEN BAY, WISC.	R. E. PASKE	WEMP	MILWAUKEE, WISC.
N. BRAUER	WTMJ	MILWAUKEE, WISC.	C. PERKINS	WVSI	JACKSON, MISS.
W. D. BUFORD	KSWO	LAWTON, OKLA.	C. B. PERSONS	WEBC	DULUTH, MINN.
V. BYERS	RYERSON INST.	TORONTO, ONTARIO	W. J. PROVIS	KXLF	BUTTE, MONT.
JOHN CHERPACK	WBBW	YOUNGSTOWN, OHIO	R. REUST	WJR	DETROIT, MICH.
S. CLARK	CKLW	WINDSOR, ONTARIO	R. ROBINSON	WACE	CHICOPEE, MASS.
K. COOKE	WGBI	SCRANTON, PA.	G. ROBITAILLE	CFPL	LONDON, ONTARIO
NEFF COX	TEL A RAY	ANDERSON, KY.	H. SINGLETON	KGW	PORTLAND, ORE.
W. COYNE	U. S. AIR FORCE		F. SLINGLAND	U. S. AIR FORCE	
M. M. CRAIN	WLBC	MUNCIE, IND.	D. H. SMITH	WCSE	PORTLAND, MAINE
ROBERT CROSS	KROC	ROCHESTER, MINN.	JULIAN SMITH	WFBR	BALTIMORE, MD.
J. DEADERICK	WMP5	MEMPHIS, TENN.	W. B. SMULLIN	KIEM	EUREKA, CALIF.
CAPT. J. R. DESSEZ	U. S. SIGNAL CORPS	FT. MONMOUTH, N. J.	M. L. SNEDEKER	WERE	CLEVELAND, OHIO
R. DETTMAN	KDAL	DULUTH, MINN.	L. S. STAFFORD	KOAM	PITTSBURG, KANS.
W. DICKSON	WABI	BANGOR, MAINE	WALLACE STANGEL	WBYA	GREEN BAY, WISC.
W. E. DIXON	WCHS	CHARLESTON, W. VA.	C. STRANG	KVOR	COLORADO SPGS., COLO.
J. FORBOM	CKSO	SUBURRY, ONTARIO	H. STURM	WHTN	HUNTINGTON, W. VA.
R. FORNIER	C.B.C.	MONTREAL, QUEBEC	E. P. TALBOTT	KROD	EL PASO, TEX.
H. GARBA	WASK	LAFAYETTE, IND.	W. H. TORREY	KGNC	AMARILLO, TEX.
P. N. GOODE	KSWO	LAWTON, OKLA.	LYNN TOWSLEY	MICHIGAN STATE COLLEGE	E. LANSING, MICH.
Z. V. GROBOWSKI	WNBH	NEW BEDFORD, MASS.	A. P. TRIPP	WPTF	RALEIGH, N. C.
R. I. HANCOCK	KDTH	DUBUQUE, IOWA	D. WHITE	KGBX	SPRINGFIELD, MO.
E. HARALSON	WPDQ	JACKSONVILLE, FLA.	C. W. WHITLEY	WSOC	CHARLOTTE, N. C.
A. O. HARVEY	KRIS	CORPUS CHRISTI, TEX.	LT. COL. WILLIAMSON	U. S. AIR FORCE	
V. HINSHAW	KFH	WICHITA, KANS.	D. WINN	KARK	LITTLE ROCK, ARK.
R. W. HODGKINS	WGAN	PORTLAND, MAINE	A. F. WOOSTER	KRMG	TULSA, OKLA.
H. HOLMES	WTOL	TOLEDO, OHIO	T. WRIGHT	A. EARL CULLUM, JR. Consulting Radio Engineers	DALLAS, TEX.
J. R. HORTON	WBIR	KNOXVILLE, TENN.	G. ZAHARIS	WTIP	CHARLESTON, W. VA.
H. HULICK	WPTF	RALEIGH, N. C.	JULIUS HETLAND	WDAY	FARGO, N. D.
E. HULL	WHLA	NIAGARA FALLS, N. Y.	R. LUUKINEN	WIRL	PEORIA, ILL.
J. KENNEDY	C.B.C.	MONTREAL, QUEBEC	R. JOHNSON	RCA	HARRISON, N. J.
J. W. KOCH	KFEQ	ST. JOSEPH, MO.	R. A. FOX	WGAR	CLEVELAND, OHIO
W. LOVELY	WEEK	PEORIA, ILL.	R. SCHROEDER	KMTV	OMAHA, NEB.
C. LUDWICK	WTSP	ST. PETERSBURG, FLA.			
E. A. MALONE	KIEM	EUREKA, CALIF.			
D. C. MCCALLISTER	WGAR	CLEVELAND, OHIO			

Display of the RCA "Basic Buy" for television broadcasters and 20-kw conversion equipment which enables 5-KW stations to obtain up to 200 kw (ERP).



J. L. Lovvorn, RCA television engineer, describing the operation of TV Microwave Relay. A laboratory test set-up used for checking the system's operation was also described.





Technical facilities to provide a complete, self-powered TV system, from cameras to receivers, are contained in four six-wheel coaches like the one shown above.





THE FOUR TV coaches were inspected by Signal Corps Procurement Officers and RCA Executives before delivery to Ft. Monmouth Laboratories.

U. S. ARMY SIGNAL CORPS NOW HAS "ELECTRONIC EYES"

With the acquisition of a complete television transmitting and receiving system on wheels, the U. S. Army Signal Corps at Fort Monmouth, N. J., is exploring new techniques for training students at the Army Signal School.

DISCUSSING features of the TV equipment are: Lieutenant Colonel L. R. Kleinknight and Major E. L. Weeks of the Signal Corps Procurement Agency, C. M. Odorizzi, Operating Vice President, RCA Victor Division, Colonel W. H. Gaeckle, of the Procurement Agency, and L. W. Teegarden, Vice President in charge RCA Technical Products.

The new TV Caravan, which was built by RCA to U. S. Signal Corps specifications, consists of four special six-wheel coaches, equipped to provide a closed-circuit TV network with live pickup, slide and film projection, and sound recording facilities. The built-in equipment is powered by gas-driven generators, making the network completely independent of any power lines. Separation distances up to several miles can be maintained between the TV pickup units and the receiving units. Pickups made in the field by the transmitting units are linked by microwave and displayed at the receiving ve-

hicles of the caravan, which are equipped with ten 19-inch TV receivers and a life-size screen TV projector. Sound is carried by a high fidelity VHF FM link.

Cameras are RCA standard field types as used by TV broadcast stations, each equipped with tripod dollies and electronic viewfinders. TV monitoring and switching equipment associated with the cameras is installed in a central operating position in the unit in accordance with TV broadcast practice. Further technical details are given in the pages that follow.



TRANSMITTING unit above contains TV cameras and microwave transmitting equipment. A monitor-control position is built into the rear of the vehicle.

PARABOLIC AND WHIP ANTENNAS BEAM VISUAL AND AURAL SIGNALS

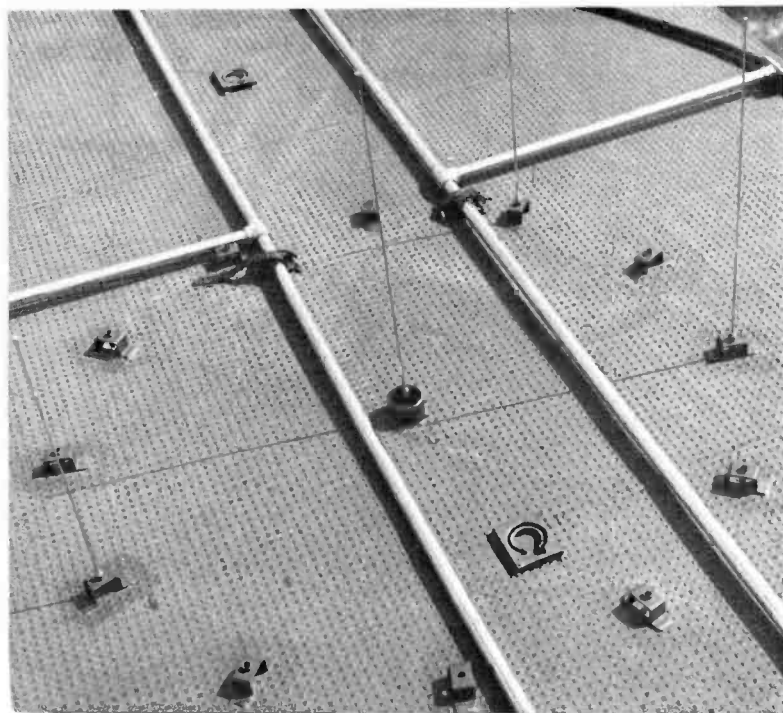

Aural signals are transmitted via VHF
 and visual signals by microwave

ROOF of transmitting unit shows circular arrangement of receptacles for inserting whip antenna elements to provide directional radiation of aural signals. By placing parasitic whips in front of the radiator (center), forward radiation is increased. A broad directional pattern is obtained with the arrangement shown.

VIEW of parabolic microwave antenna mounted on the roof of the vehicle. This location provides a high vantage point, and thus permits transmission of the picture over a greater distance to an identical parabola mounted on the receiving vehicle.

TWO coaches make up the transmitting units and two the receiving units. One vehicle in each case contains the gas-generator power supply equipment, repair benches, and cable stowage space. The transmitting power unit is equipped with two 15 KVA generators, one of which can be used to supply power for lighting the scene.



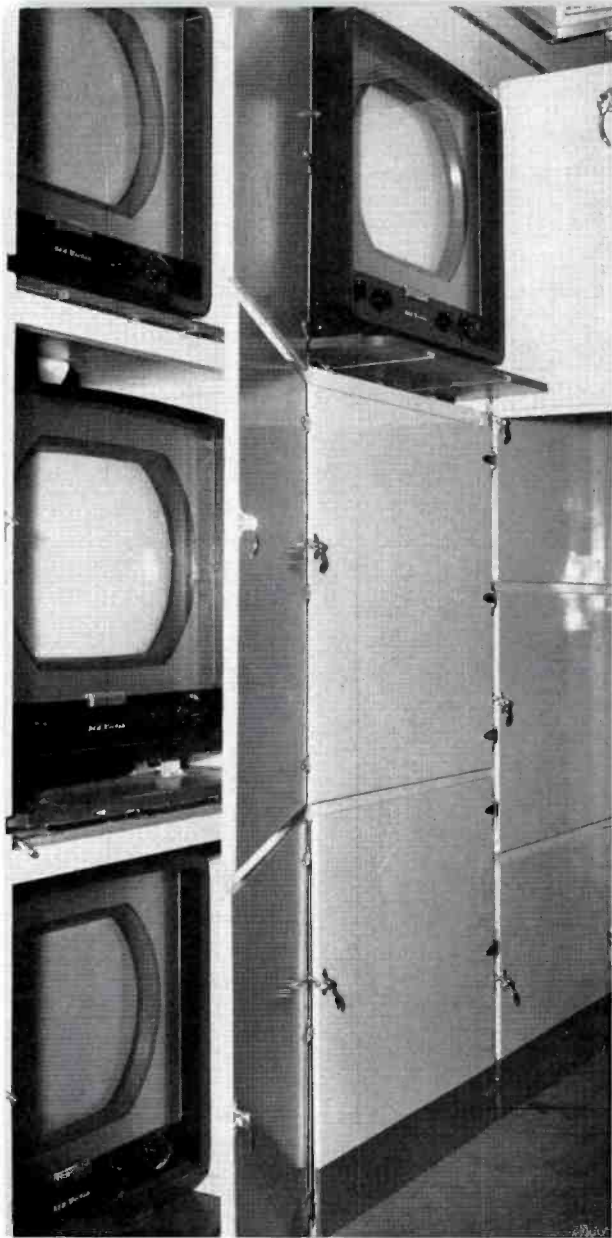

**INTERIOR VIEWS
OF THE RECEIVER
DISPLAY UNITS**

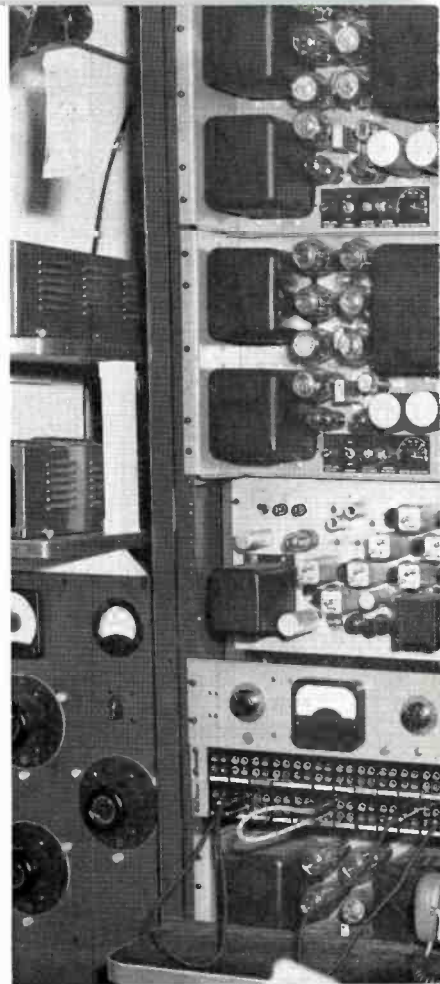

IN THE receiver display unit, shock-mounted compartments provide storage for ten RCA 19-inch TV receivers for transport to various receiving locations. For operation, the receivers are removed, interconnected and placed on special dollies shown on the opposite page. Cables stored in the power unit provide operation of the receivers up to 500 feet from the receiving vehicle.

THE receiver display unit houses a 16mm TV projector, film camera and slide projector, which are permanently installed in the coach. A life-size screen projector and folding screen (visible at top of picture) are removed and set up for operation at the desired location.

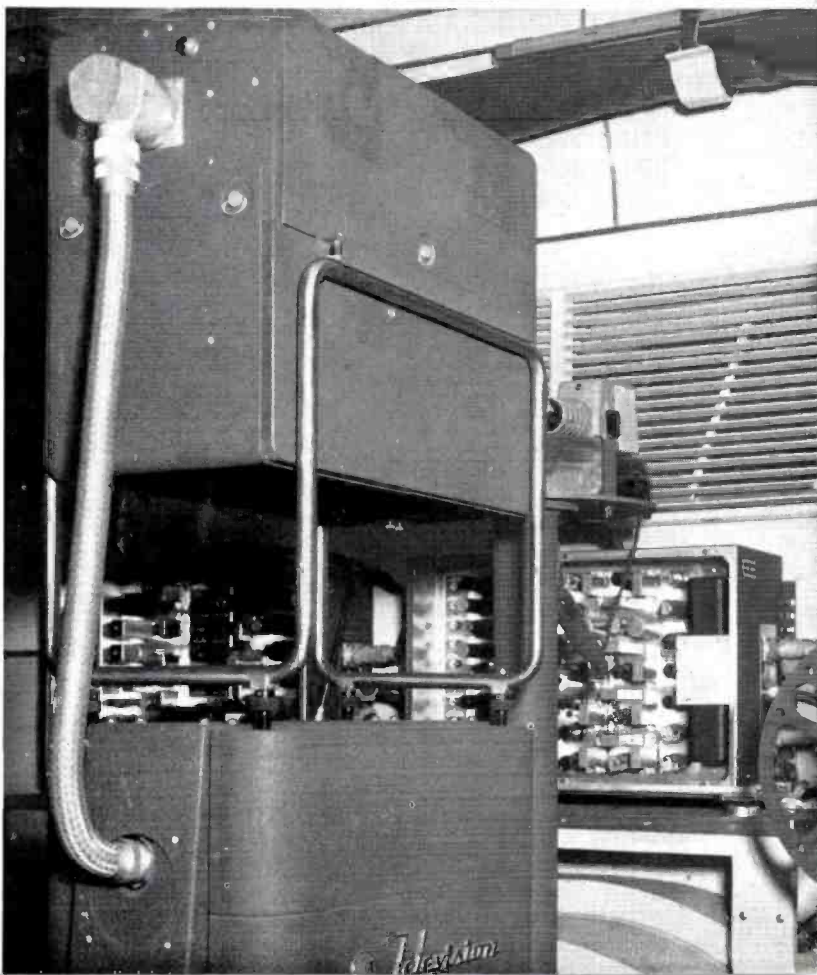

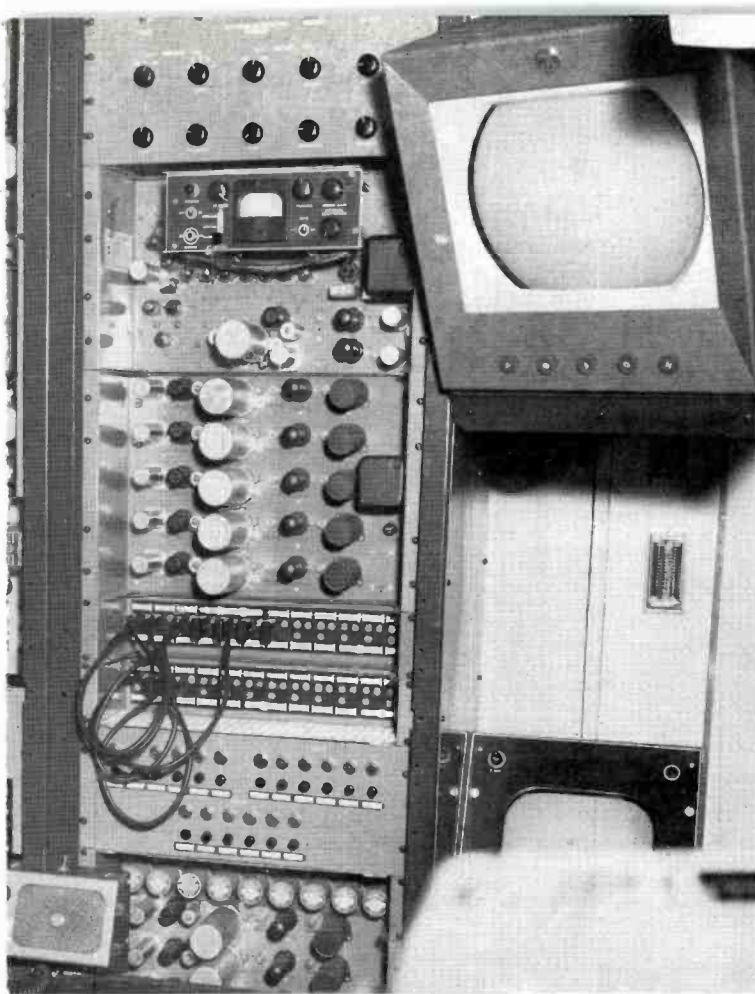

ARRAY of rack-mounted units surrounding the control desk in the receiving unit. From top to bottom in the left-hand rack are two heavy duty power supplies, the two-way radio communication receiver, audio amplifier, and jack panel. The right-hand rack contains a grating generator, microwave receiver control unit, video distribution amplifier, video jack panel, and video switching panel. Small control unit in center of desk is for two-way radio system. TV line monitor at upper right is Broadcast Type TM-2B.

CLOSEUP view of the special dollies which unfold to provide convenient mobile tables for moving the receivers around in classrooms.

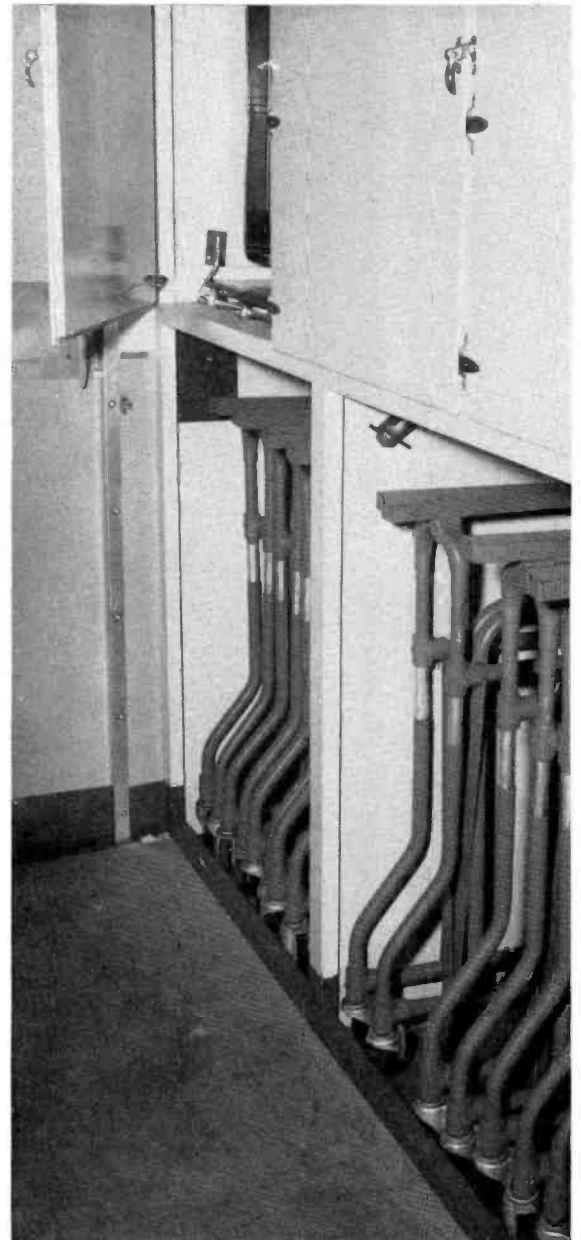
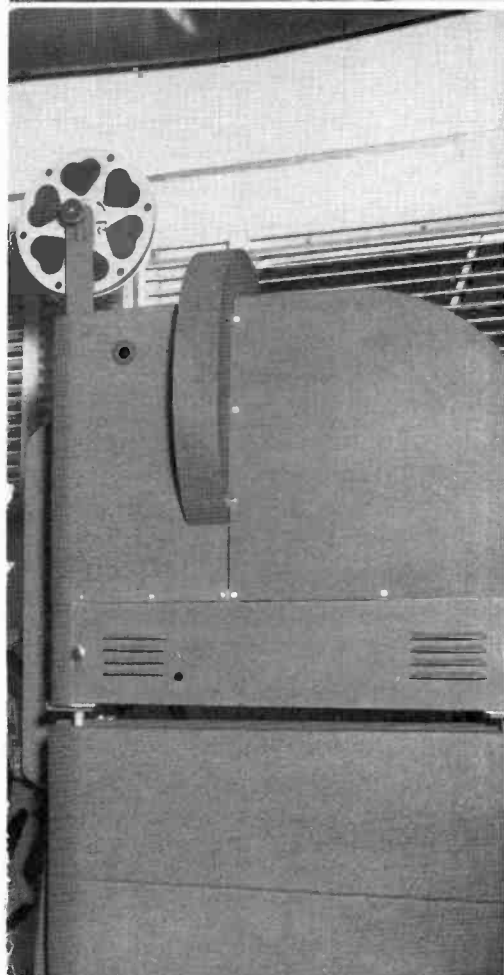



VIEW through the rear doorway of the transmitting power vehicle. Cable reels at left (and right) of corridor are for storing camera cables and power cables. Repair benches can be seen forward of the reels, and one of the gas-engine generators is visible in the next compartment behind the driver's compartment.

**INTERIOR VIEWS OF THE
TV TRANSMITTING UNITS**

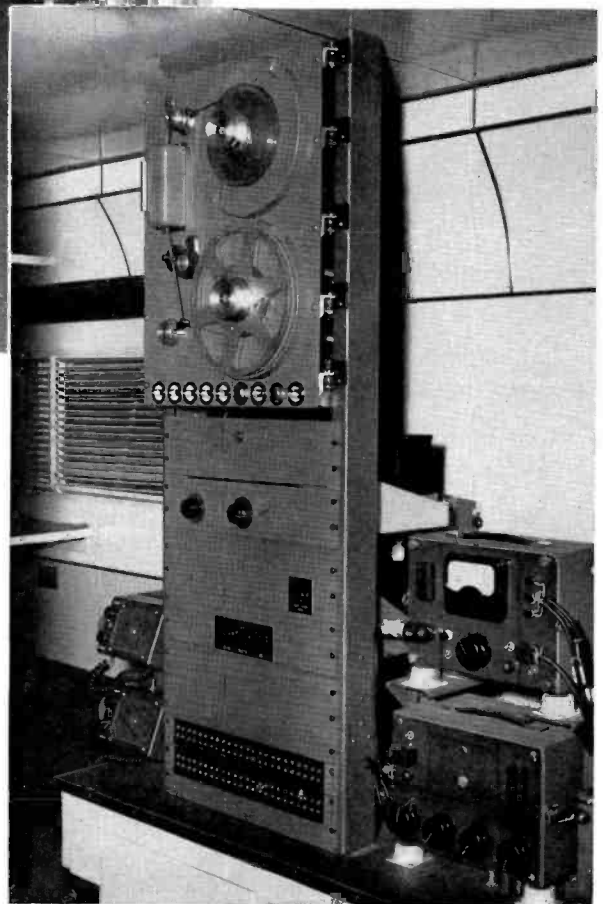

EQUIPMENT in transmitting unit includes broadcast type High Fidelity Tape Recorder and mixer-amplifiers. Two control units at left are for two-way radio "order-wire" systems.

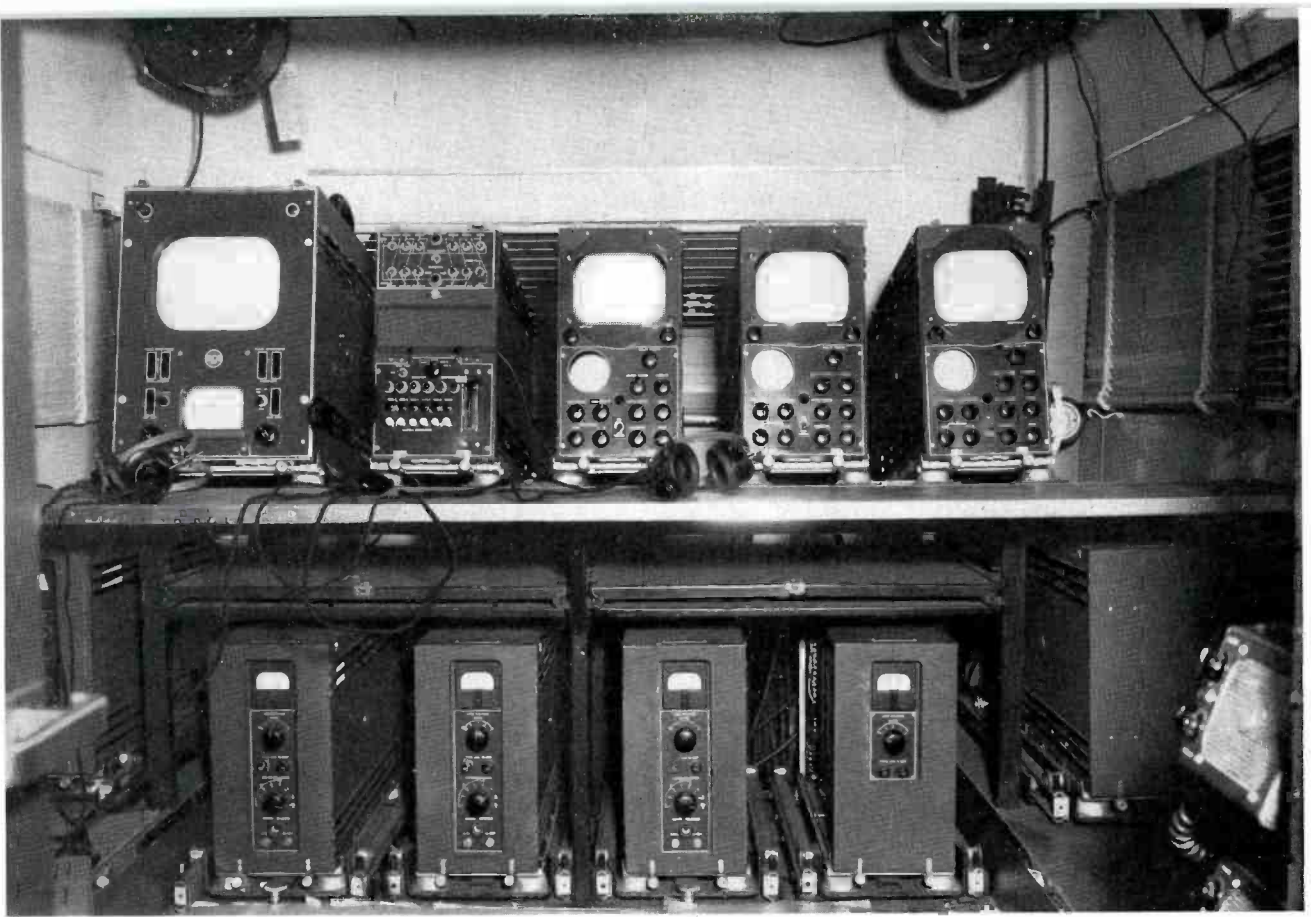

VIEW facing the control and monitoring position at the rear. All are portable type units with rail shockmounts which permit them to be rolled forward for accessibility. Desk-mounted units from left are the Master Monitor, Switcher, and three Camera Controls. Below the desk, the cover panels are raised to show the power supplies and sync generator.



SHOWN LEFT are RCA Engineers who participated in the design of the TV mobile units. Top, left to right are L. E. Anderson, R. J. Smith, J. L. Lovvorn, and J. H. Roe. Inset shows D. H. Vance, Project Engineer.

NEW 5 KW AM TRANSMITTER

MECHANICAL DESIGN FEATURES

By **M. H. HUTT**
Engineering Products Department

First considerations, of course, in the design, planning, and mechanical layout of a new transmitter are the basic needs and operating requirements to be met in the Broadcast Field. Moreover, most of these

technical requirements have been very well established by Broadcasters with over thirty years of operating or "on-air" experience.

Therefore in the design of the RCA BTA-5G/10G (5/10 kw) Transmitter care was exercised to retain the many design

features "proved-in" by its predecessors . . . and to provide new and novel ideas, as well. Listed here are some of the major factors which had to be taken into consideration in the final design of the BTA-5G.

1. Reduced cost without any sacrifice in quality long established by previous RCA Transmitters.
2. Reduced weight and size.
3. Simplified operation and maintenance.
4. Simple and easier to install.
5. Convenient and economical to convert to 10-kw operation, and to add phasing equipment.
6. Accessibility to all components and tubes.

Only 4 Cubicles—Easily Handled

The (BTA-5G) 5-kilowatt AM Transmitter design consists of four major units: namely, the exciter, the power amplifier, the modulator, and the power rectifier units. With the addition of a few components, the BTA-5G can be converted into a 10-kilowatt unit without increasing cabinet and floor space. Cabinets of companion design and styling for phasing equipment may also be added where directional operation is required.

Each cubicle or cabinet measures approximately 27 x 30 x 84 inches, which is a convenient size for handling in elevators, during shipping, and installation. Solid, rigidly formed panels of $\frac{1}{8}$ -inch thick aluminum are used to construct the cabinet enclosures rather than the more common welded steel angle frames used with panels, brackets and plates of heavier material. This fact alone accounts for a considerable saving in weight and increases the ease with which the units can be

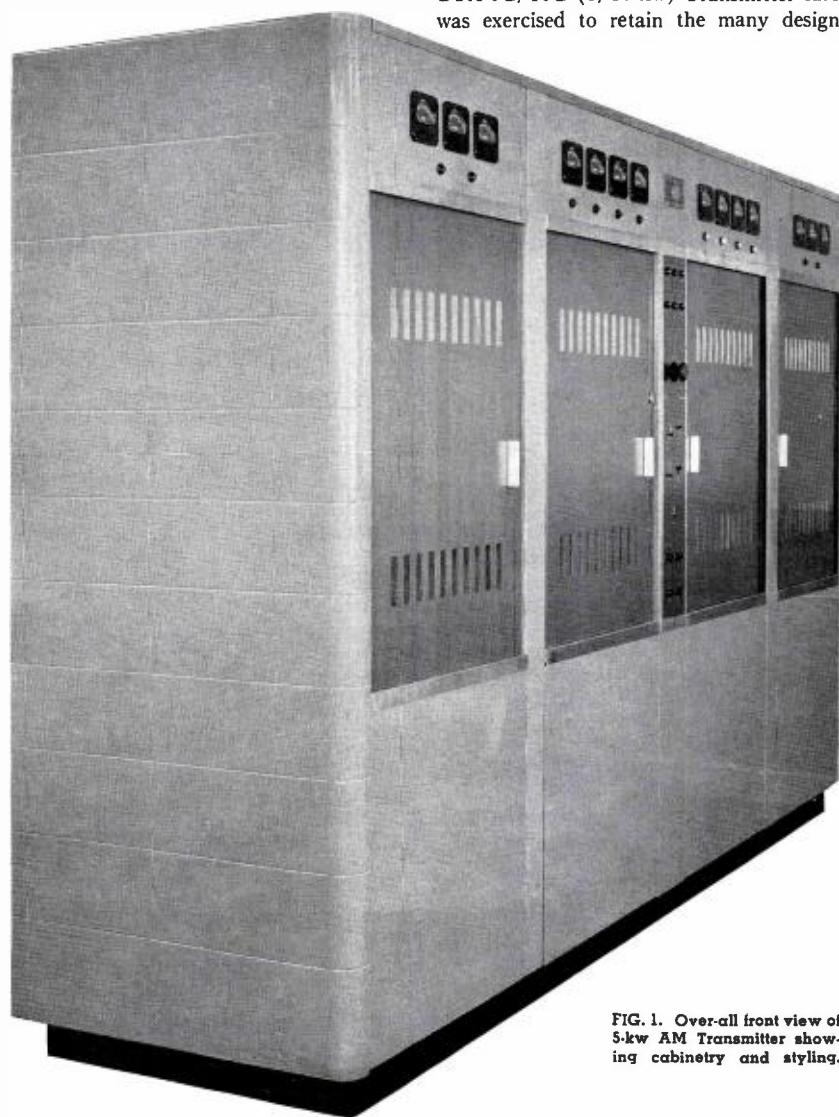

FIG. 1. Over-all front view of 5-kw AM Transmitter showing cabinet and styling.

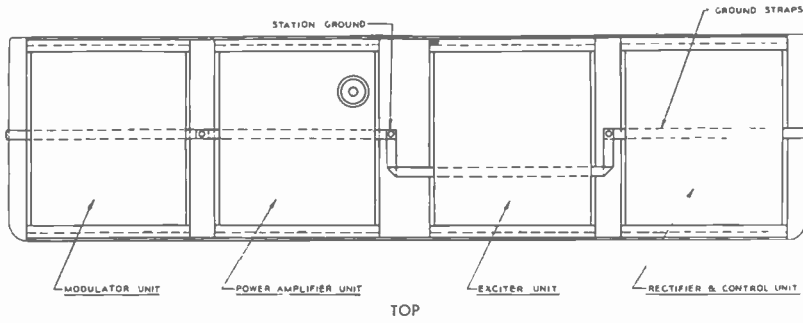
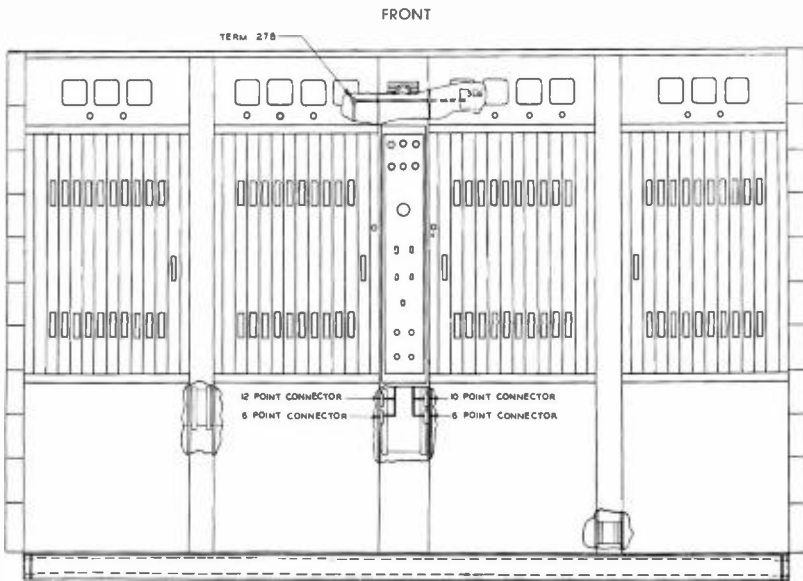

FIG. 2. Lower shows arrangement of cabinets and necessary connections for assembly. Upper shows base diagram of individual units.



handled. Additional interior space is also gained by using the formed panel construction.

A sturdy steel base is used to support the vertical chassis and the two vertical side panels. The base has also been formed to allow the fork of a "pilot jack" (small hand or motor-powered lift truck) to reach under and through it for moving individual units during assembly and test. The four cabinets completely assembled require a total floor space of only 10 feet 10 inches in length by 30 inches in depth. The sliding doors, a new feature described later, make it possible to conserve additional floor space because no clearance is needed to accommodate hinged doors.

Handy Wire Ducts Provided

Two wire ducts, one for the front and one for the rear, made of formed sheet

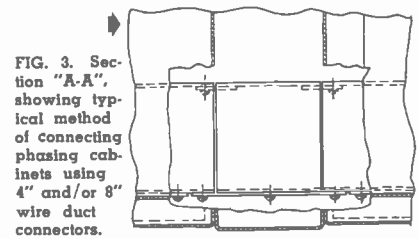

FIG. 3. Section "A-A", showing typical method of connecting phasing cabinets using 4" and/or 8" wire duct connectors.

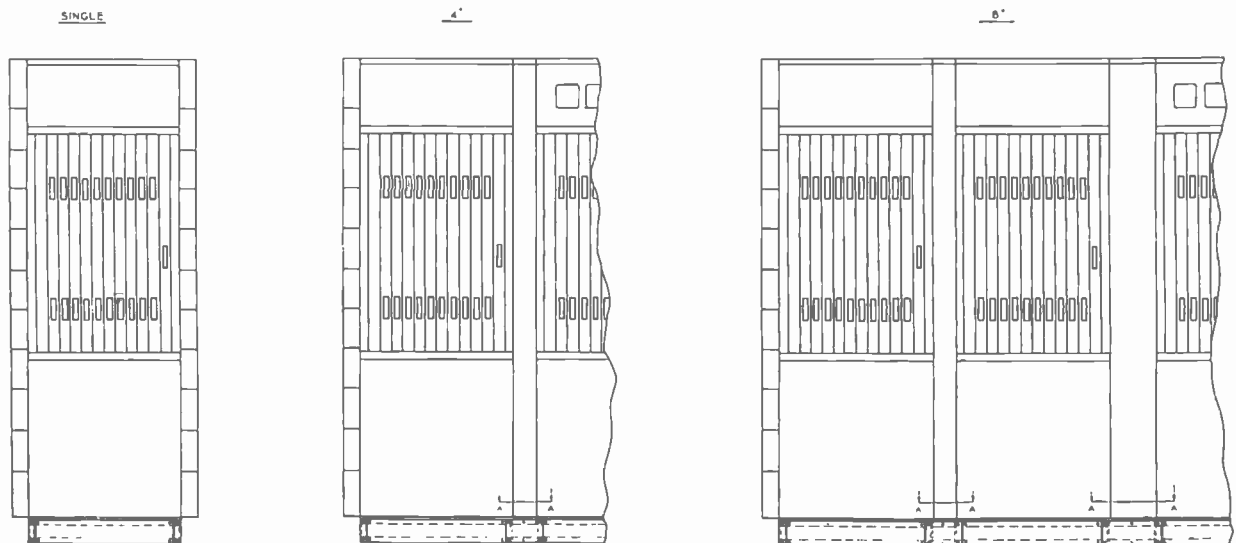

FIG. 4. Sketch showing companion phasing or test equipment racks available to match transmitter; either located separately or as part of the transmitter cabinet line-up.

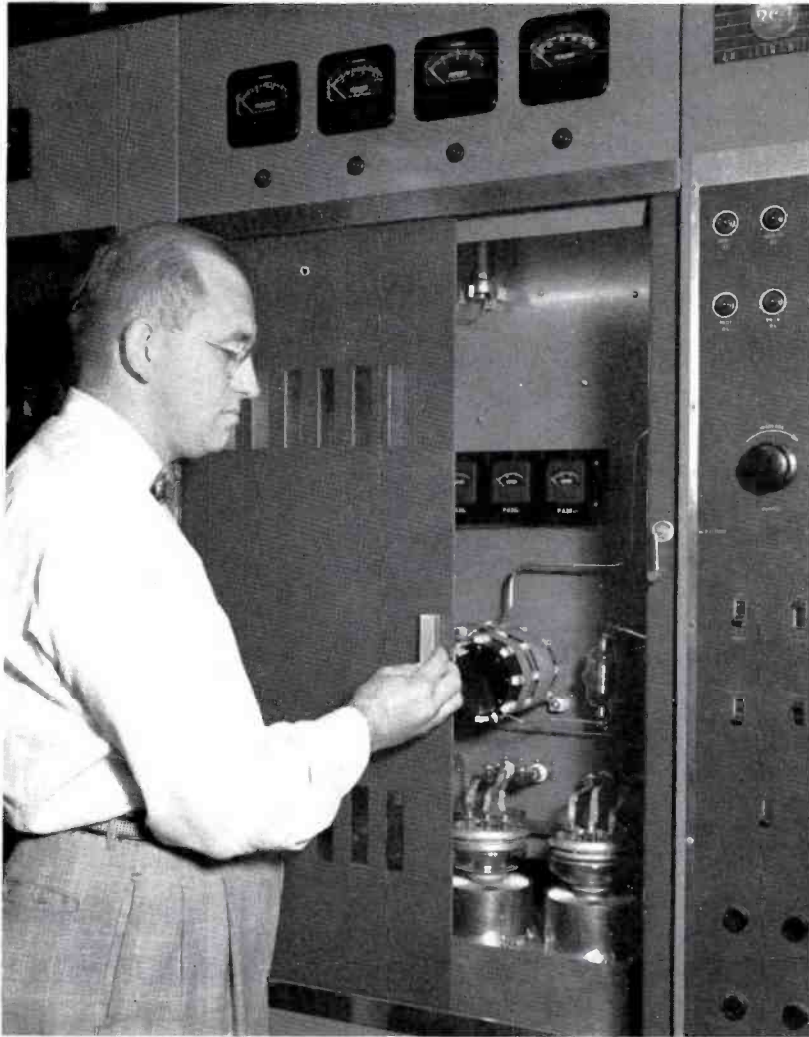
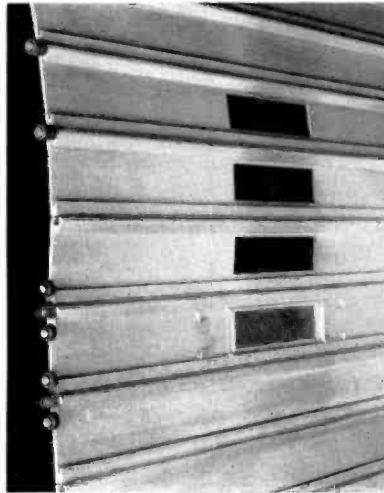
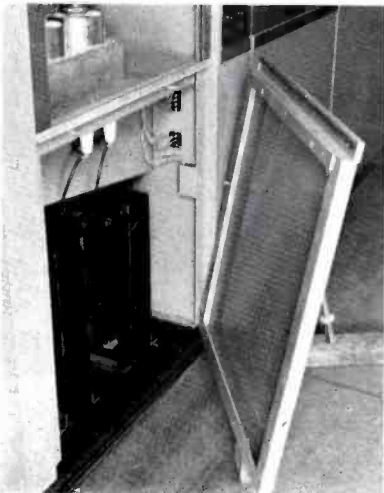

FIG. 6. View showing removable lower panel providing access to components seldom requiring inspection or maintenance.

FIG. 7. Details of "sliding-door" aluminum extruded strips with observation windows and castor assemblies.



steel, are long enough to reach the entire length of the four units comprising the complete transmitter. When the transmitter is installed, these wire ducts are first located, leveled and secured to the floor. This provides two good rails on which the transmitter units can be set and finally located. The formed bases of each cabinet are notched to clear the wire ducts and also to align themselves up with the cable openings.

Another advantage of a wire duct of this type is the ease with which the interconnection cable and power connections can be installed. The wire duct is open along the entire front side, as are the "U" shaped notch openings for the cable connections of each unit. Thus, the interconnection cable may be simply laid in place, and the task of weaving the cable in and out of openings and holes is eliminated. As the cable is placed in the duct, each branching leg of wires will automatically extend up through the notches provided in the base units to their appropriate terminal boards.

Interior Arrangement

On each base unit are assembled the vertical chassis and the two vertical side panels; which are fastened together to

FIG. 5 (at left). New type, horizontally-sliding doors make access to cabinets a simple matter and present a neat, business-like appearance.

FIG. 8. View of door track assembly and actuating arm for high voltage grounding.

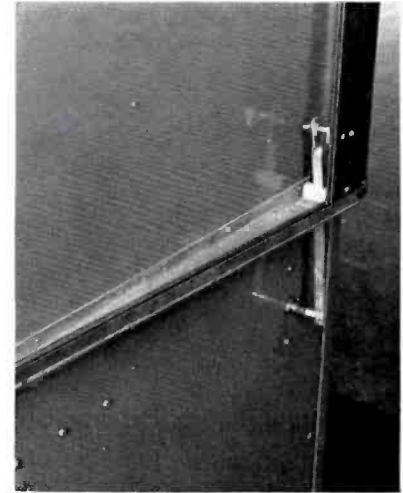

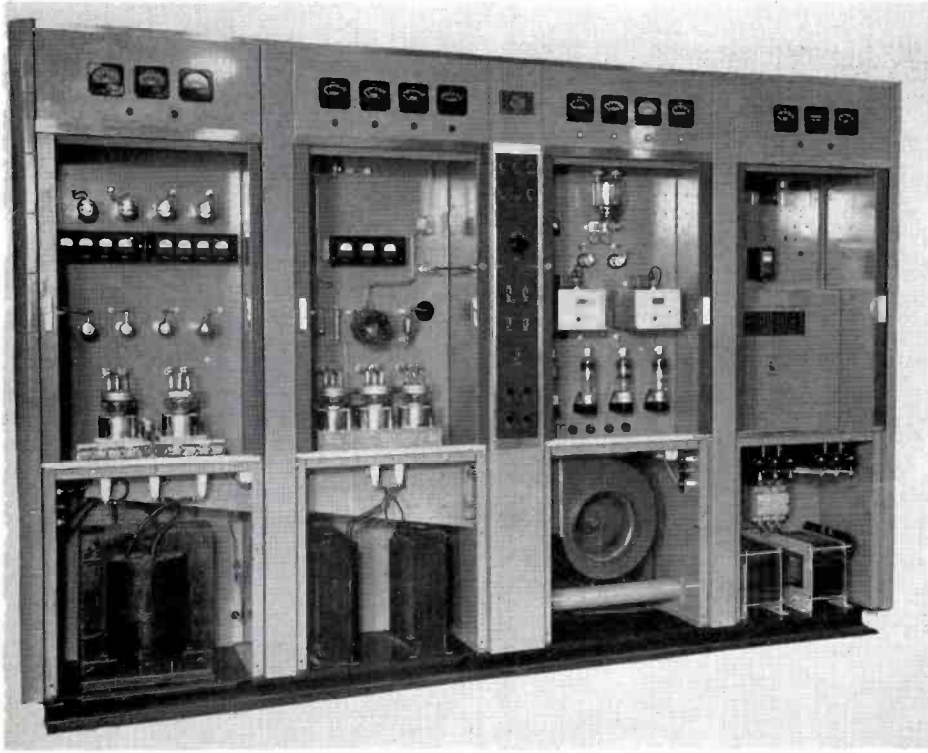

FIG. 9. Front view with sliding doors opened and lower panels removed to show interior arrangement. Note the similarity of mechanical layout.

form an "H" section. However, prior to assembling the cabinet unit, the vertical or center chassis may be assembled and wired as a sub-assembly item. In all units except the exciter, this vertical chassis

divides the unit into two equal front and rear compartments. In order to provide additional space for a blower in the lower compartment and to allow accessibility to the crystal oscillators and other compon-

ents, the chassis in the exciter is forward of the center and does not extend into the lower compartment.

Two shelves, one front and one rear, located approximately 30 inches from the floor, further divide the units into upper and lower compartments. This provides a means for mounting additional equipment which must be fixed in place. In the modulator and power amplifier units, the front shelves provide means for supporting the 5762 air-cooled power tubes. The air is piped from the blower mounted in the exciter through a duct system assembled directly to the under side of the shelves. The compartments below the shelves are used front and rear to house the heavier components which rarely require service. Removable panels below the door area provide easy access to these lower compartments. These lower panels are quickly removed by releasing two camlock fasteners just inside the lower edge of the door opening above the shelf. An interlock switch provides the protection against high-voltage when these panels are removed. All large transformers, reactors, voltage regulators, capacitors, circuit breakers, etc., are housed in the lower compartments and, of course, the blower is situated in the lower compartment of the exciter. The lower rear panel of the exciter unit also contains an "intake" air filter. This filter is a dry type and can

FIG. 10. Close-up view of high-voltage grounding switch.

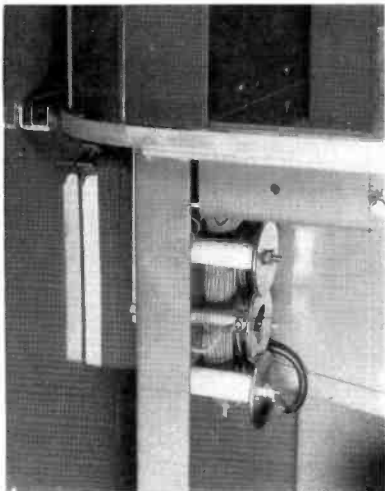
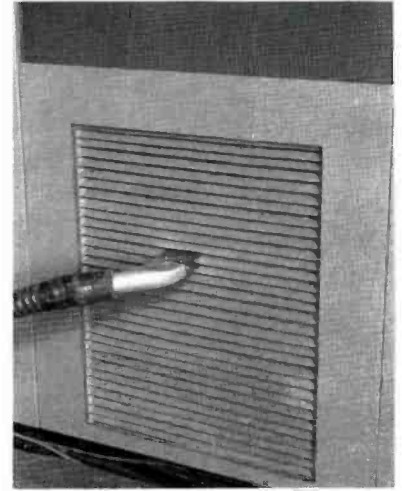

FIG. 11. View showing inter-connecting cables and terminal board "tie" connections.



FIG. 12. Rear lower panel of the "exciter" cabinet containing air filter and vacuum nozzle for easy removal of dust and dirt.



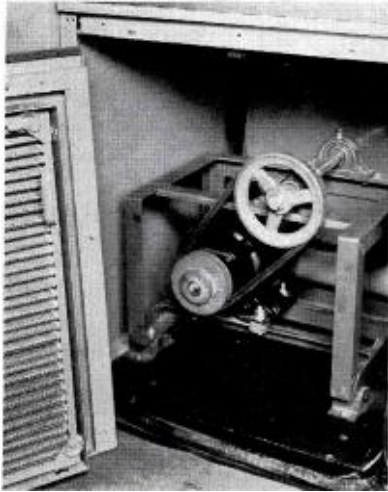

FIG. 13. View with panel removed to show easy access to blower and companion motor.

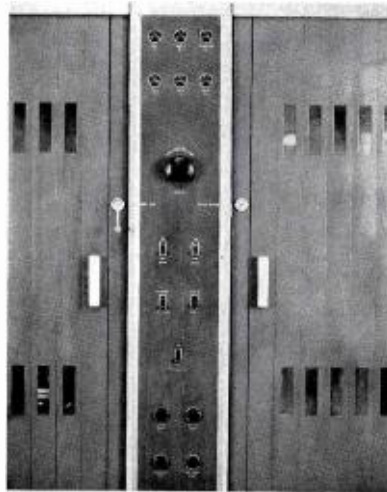

FIG. 14. Close-up of the central control panel of the 5-kw AM Transmitter. Note that controls are located all on an 8" filler channel.

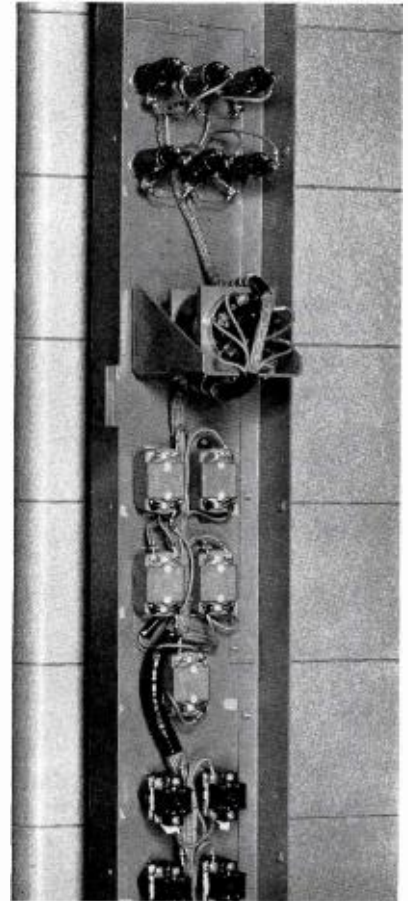

FIG. 15. View with central filler channel removed to show components associated with control panel.

be cleaned with a vacuum cleaning attachment without removal from its mounting.

New "Sliding-Panel" Doors

The upper front and rear sections of each unit contain the components which require occasional attention and service. This requirement is facilitated by the use of new horizontal, sliding doors. Interlocking, extruded aluminum slats are used to make up the doors. Small rubber caster assemblies riding in an upper and lower track guide the doors as they move from the front to the side of the cabinets. A 4-inch separation between units provides the space into which the opened doors slide, with one door entering from the front and another from an adjacent cabinet entering from the rear. A series of openings in certain slats provide the windows necessary for observation of tubes and components. These openings are protected with plexiglass held in place by small spring clips for easy removal. Each door is equipped with a latch assembly which locks the door in place while closed and is easily tripped while pushing the door open. The door also activates an interlock switch and a ground switch, which both operate at the desired position of the door to provide full protection. However, the front door of the rectifier and control unit is not interlocked and therefore provides the access to main switches, and circuit breakers.

Front Panel Styling and Control Grouping

Above the sliding doors on the transmitter front are the meter panels for mounting meters and indicator lamps. Below the doors are the lower removable panels. Both panel areas are separated from the door area by trim strips. In general, overall external appearance and styling matches other existing RCA transmitter equipment.

The 4-inch spaces provided between units for housing the open doors and door tracks are covered with filler channels which are fitted into the overall styling. The center filler channels are 8 inches wide and the front center channel contains the external transmitter controls.

Both units adjacent to the center section have only their rear doors entering this area. This arrangement leaves the front section of this area free for locating the necessary controls. There are only two units with components requiring external tuning controls: the power amplifier to the left of the control panel contains a variable vacuum capacitor which is controlled manually by a vernier dial mounted on the door jamb adjacent to the control panel; and the exciter to the right of the control panel has a "slug-tuned" coil which is controlled manually by a similar dial located on its door jamb. Therefore, these dials are in the vicinity of the control panel and may be grouped with the other controls to form a central control panel. No further

mechanical mounting is required, since installation of these assemblies is part of the completed unit.

Internal Components

Internally the mechanical layout and arrangement is similar for each of the four transmitter cabinets. As mentioned previously, each unit is made up of a vertical chassis and two vertical side panels fastened together to form an "H" section. The shelf level is just about even with the lower edge of the door. Except for the exciter unit, the vertical chassis extends from the base to the top cover. In addition to a more simplified assembly, all the smaller components assembled on these chassis are made extremely accessible. The small tube sockets are mounted vertically and the tubes horizontally. This arrangement makes all wiring easily visible and accessible. The

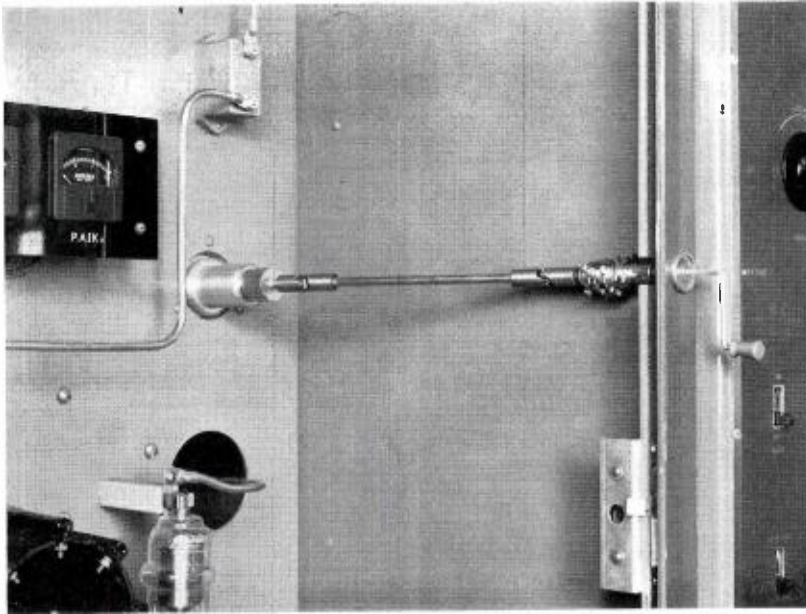

FIG. 16. View of mechanical power amplifier tuning control located on central control panel. Note door interlock switch at lower right.

chassis is placed approximately 15 inches from the door opening so that all components on the chassis are within easy reach. All components such as: capacitors, resistors, coils, etc., are in most all cases mounted on the rear side of the chassis. This results in a clean arrangement on the front of the chassis where only the necessary tubes, meters, crystal oscillators and associated components are mounted.

The modulator and power amplifier units are very similar in internal arrangement and follow the general "chassis and shelf" layout described above. The associated power-rectifier unit is divided similarly into compartments for housing the components which supply the voltage to the modulator and power amplifier. The front compartment behind the door of the power-rectifier is accessible at all times and is not interlocked but fully protected, to permit operation of control switches. The rear compartment of this unit, behind the door, contains a special thyatron control circuit, the components of which are arranged on a hinged insulated chassis. An insulated shelf is also used to support the thyatron

tubes which are visible from windows located on front of the transmitter door. A set of arc-back indicator lamps are also mounted on the thyatron tube shelf and are visible through jewels mounted in the vertical chassis.

Forced Air Cooling

A single blower located in the lower part of the exciter cabinet supplies all the air required for cooling the 5762 power tubes in both the modulator and power amplifier.

Additional cooling required for components is also piped and bled from this same source. The air is carried from this common source by a simple air duct system that is part of the individual cabinet assembly, as described previously. Smaller pipe ducts or openings leading off the main ducts direct the air to the required "hot-spots."

Directly above the air ducts on the shelves of the modulator and power amplifier are mounted the 5762 tubes on an insulated box type mounting. This box is made of mycalex stock of sufficient size to provide the support and insulation required. This assembly is divided, in the modulator, to provide two separate tube mountings for a push-pull connected arrangement. In the power amplifier, the assembly is combined to provide a parallel connected arrangement for two tubes when operating at 5 kilowatts, or three tubes when operating at 10 kilowatts.

The four thyatron tubes, located in the rear of the "power-rectifier" because of their function, are spot cooled by a small blower assembly mounted below the tube shelf. Except for this small unit blower, all cooling air is supplied by the one main blower driven by one motor. There is one air filter to service and maintenance in general is minimized.

The blower motor is coupled to the wheel through a variable pitch pulley and "V"

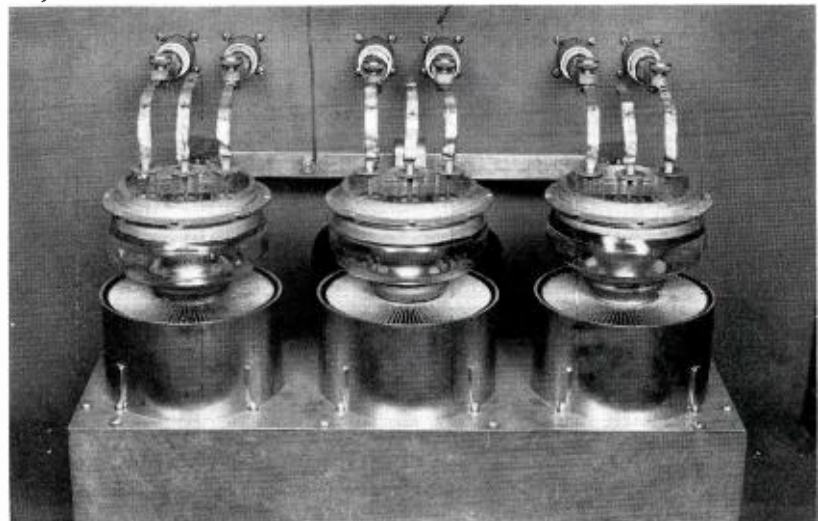

FIG. 17 (at right). Mechanical assembly of 5762 tubes used in power amplifier unit.



FIG. 18. Front view of power amplifier unit showing 5782 tubes.

belt. The drive thus provides for variations in air requirements due to differences in altitude locations or whether operating at 5 or 10 kilowatts.

The cooling air is vented through perforated covers in the tops of the cabinets. If it is exhausted into the operating room, ventilating fans located near the ceiling may be used to discharge the heated air in the summer, or, in the winter the exhaust air from the transmitter may be used to heat the room. If the operating room is air conditioned, the heated air from the transmitter may be exhausted outside by ducts, leading from the tops of the cabinets.

Increase to 10 KW

The addition of two reactors, a power amplifier tube with its voltage regulated transformer, and a few minor components are all that is required to convert from a 5-kilowatt transmitter to a 10-kilowatt transmitter. The space and mounting facilities for this conversion are provided in the 5-kilowatt design without additional space or expense. These space requirements are kept within the limitations of the original size and design.

Phasing and Stand-by Considerations

Provision has been made in the design to easily add additional cabinets for antenna



FIG. 19. Front view of modulator which also uses the same type tube, 5782.

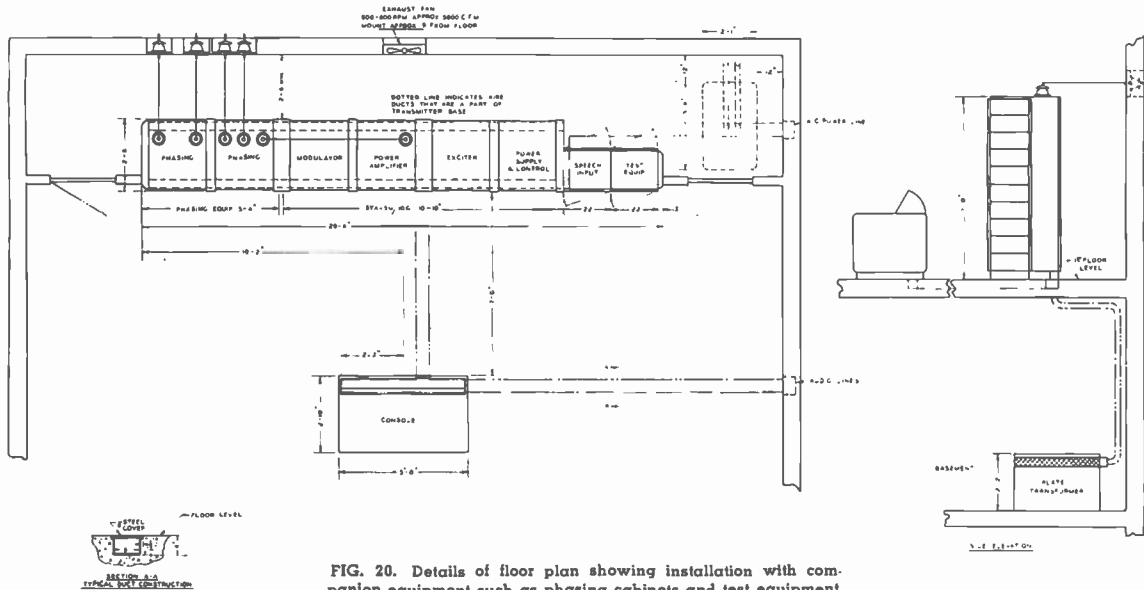

FIG. 20. Details of floor plan showing installation with companion equipment such as phasing cabinets and test equipment

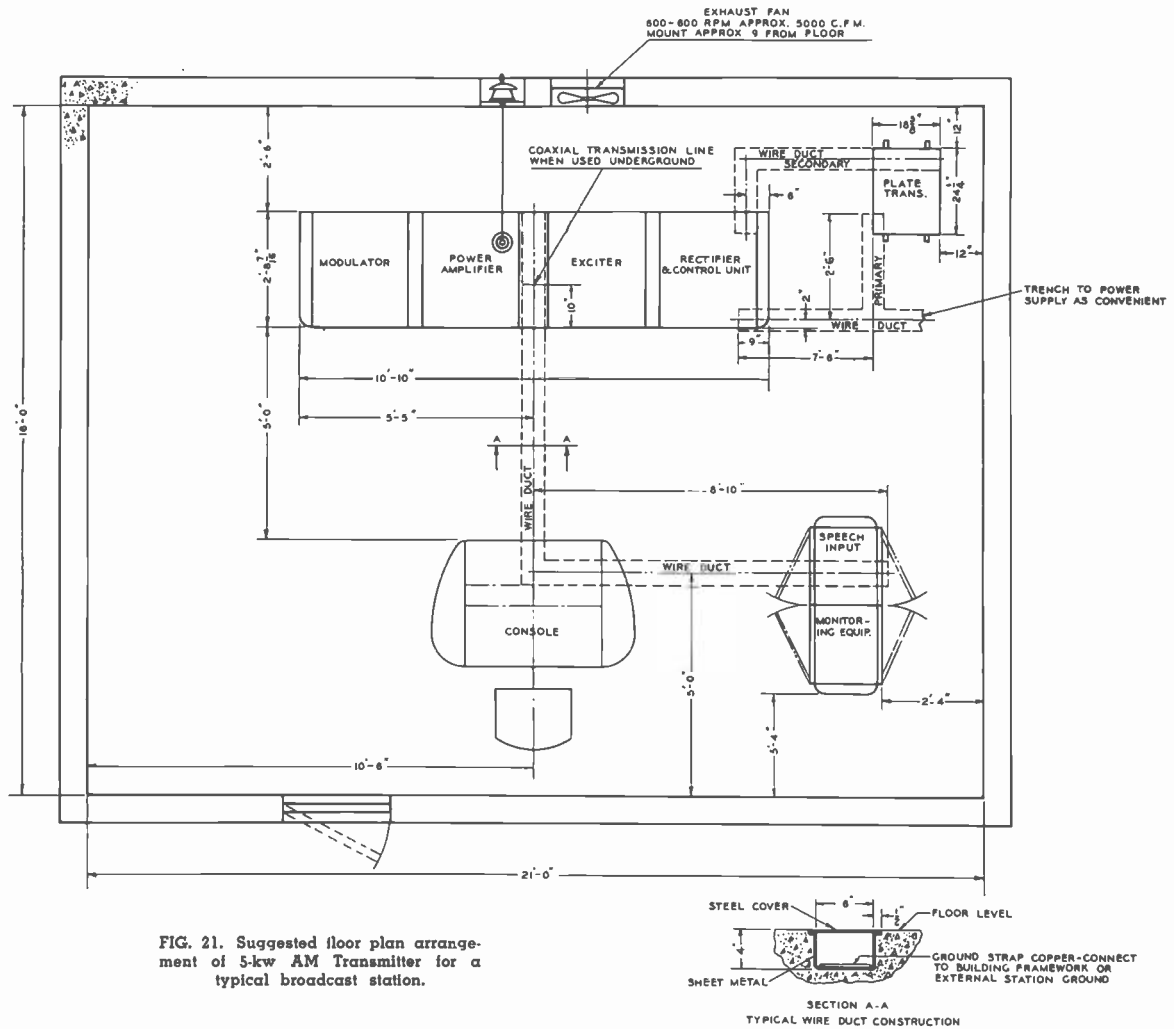

FIG. 21. Suggested floor plan arrangement of 5-kw AM Transmitter for a typical broadcast station.

phasing equipment. These cabinets are similar in design and are supplied as required by the individual radio station. By using a combination of wire ducts, filler channels and trim strips, these additional cabinets are easy to install and blend well with the overall styling. The new BTA-1M transmitter (a one-kilowatt AM transmitter) has also been designed to be housed in a single unit of this same design. Therefore, it can be installed adjacent to the BTA-5G or 10G as a "stand-by" unit and still be in harmony with the overall equipment.

Simplified Installation

Installation has been further simplified by the fact that each unit is shipped com-

pletely assembled, except for the few components that are removed to prevent damage in transit. Except for the interconnection cable, one buss, three "boot", and three ground strap connections are all that are required during installation. Wire duct covers, end shields, filler channels and top trim strips are all assembled with a minimum of hardware, using the same size throughout.

The control panel on the front center filler channel is easily removed for servicing by removal of several screws and four cable plugs. Thus, the control panel may be placed on a bench or table for any service work that may be required.

The present day manufacturing problems, which involve high costs for fabricated parts and assemblies, together with the difficulty of procuring materials, have been held to a minimum. However, the BTA-5G/10G design has provided the many additional features that have been described. It was the removal of the unnecessary parts and ofttime cumbersome items that made it possible to accomplish this present improved design. In all respects the BTA-5G/10G Transmitters and their associated equipment are incorporated with the single purpose of fulfilling the needs and desires of the broadcast station.

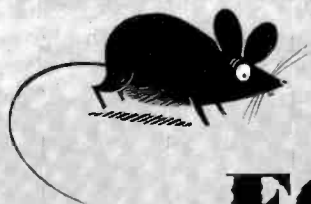

HAM FORUM



A DEPARTMENT FOR THE BROADCAST RADIO AMATEUR

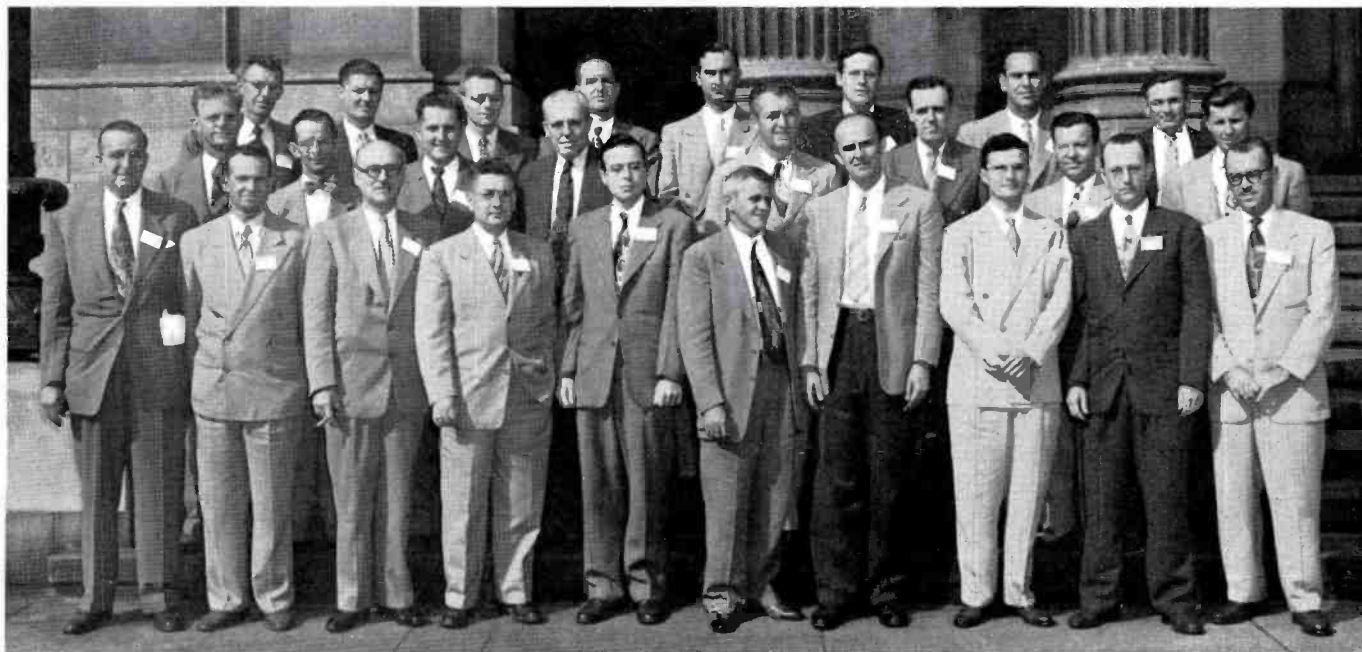

ALL THE ABOVE were found to be hams of a group of nearly one hundred attending the RCA TV Technical Training Session in Camden last September.



HAMS "JAM" PROGRAM

No, these are not BCI or TVI culprits, but the fact is 38 of the 80 broadcasters who attended the RCA TV Technical Training Program are Hams. Most of the 38 appear in the photo, but several others were not on hand at the time it was taken.

J2 VISITS W2

... Harry Yoneda, J2NG, is shown at left inspecting RCA RT-11A High Fidelity Tape Recorder with HAM FORUM Editor during a visit to the RCA Camden Plant. Mr. Yoneda, Chief Engineer of Program Production Studios in Tokyo and Vice Director of the Radio Department of Nippon Koken, Inc., is presently studying Broadcasting at Ohio State University.

HAMS IN ABOVE PHOTO:

Front row: E. T. Griffith, W3HUV (RCA), Camden; John Adams, W5PAH, Wichita Falls, Tex.; E. C. Hull, W2RR (WHL), Niagara Falls, N. Y.; H. Garba, W9LBE (WASK), Lafayette, Ind.; Bob Reust, W8ZJP (WJR), Detroit, Mich.; E. E. Haralson, W4DAA (WPDQ), Jacksonville, Fla.; Z. V. Grobowski, W8KVD (WNBH), New Bedford, Mass.; Neff Cox, W9MDX, Henderson, Ky.; L. S. Stafford, W0BLR (KOAN), Pittsburgh, Kan.; Charles W. Whitley, W4OXR, Charlotte, N. C.

Back row, left to right: Walter Dickson, W1DLC (WABI), Bangor, Me.; Hal Sturn, W8PTJ (WHTN), Huntington, W. Va.; Bob Cross, W0KVV (KROC), Rochester, Minn.; Lynn Towsley, W8JZV (Michigan State), E. Lansing, Mich.; Jim Barkley, W5CT (RCA), Camden; A. F. Wooster, W5RFD (KRMG), Tulsa, Okla.; Dan H. Smith, W1SNV (WCSH), Portland, Me.; Phil Baldwin, W1ZW (WHDH), Boston, Mass.

HAM PARADISE!

Here you see what we call a ham paradise. Mrs. Gordon, who is transmitter operator at WTJS, Jackson, Tenn., is calling CQ on the ham rig while her OM, Robert Gordon, W4HXC and Chief Engineer of the 50 KW (ERP) FM station keeps the log up to date. You see, Mrs. Gordon, whose name is Inez, has an active interest in amateur radio too; in fact she holds W4HPO in addition to her commercial ticket. Mr. and Mrs. Gordon live in the WTJS transmitter apartment. They both operate 20 and 75 fone, but Bob says the XYL prefers 40 CW. . . . *It must be wonderful to hear the XYL insist on staying home to work dx!*

. . . The W4HPO-W4HXC final is a 304TL running 700 watts, modulated with a pair of 304TL's. Antennas consist of a full wave zepp for 75, a 3-element beam for 20, and 4-element beam for ten. The 3- and 4-element beams are mounted in the same plane. . . . Bob informs us that Tim Marsh, W4JWV of Shelbyville, Tenn., Chief Engineer of WHAL, is on 75 and 20; and Charlie Walker, W4JMW, Chief at WNEX, Macon, Ga., is on 75.

. . . Jim Doyle, W5CVI, of KSIL Silver City, N. M., will have a half gallon on the air soon . . . *send us a few pix, Jim.*

73, W2BCV

Address correspondence to:

HAM FORUM
Marvin L. Gaskill (W2BCV)
Associate Editor, Broadcast News
RCA, Camden, New Jersey

Middle row: H. H. Newby, W4OAW (KAK), Wichita, Kan.; W. Wenger, W5TCN (RCA), Dallas, Tex.; Ray Forbon, VE3JYY (CKSO), Sudbury, Ontario; Wm. H. Torry, W5GCF, Amarillo, Tex.; Cliff Ludwick, W4ZKW (WTSP), St. Petersburg, Fla.; Rudy Fournier, VE2UH (CBC), Montreal; R. I. Hancock, W4PMK (KDTH), Dubuque, Iowa; Robt. G. Wilson, W3GHD, Philadelphia, Pa.

Others not shown in photograph: S. Clark, VE3FP (CKLW), Windsor, Ontario; Ed Clammer, W2BDI (RCA), Camden; Roy J. Marion, W2EH3 (RCA), Camden; Al Howard, W3BET, Philadelphia, Pa.; John McGoldrick, W3DXT (WQAN), Scranton, Pa.; W. E. Johnson, W3LAZ, Philadelphia, Pa.; W. Lovely, W9DRT (WEEK), Peoria, Ill.; Walt Varnham, W4FIG (RCA), Kansas City; I. Wesley Koch, W4GAP (KFEQ), St. Joseph, N. J.; R. J. Schroeder, W4AWI (KMTV), Omaha, Neb.; Thomas P. Tissot, W6LEV (RCA), Camden.



ABOVE are Inez and Bob Gordon in their ham shack, which is located in the WTJS transmitter building. Their 700-watt ham transmitter (not shown) is built into a 48-inch cabinet. Below, Inez is tuning up the exciter of the station's RCA FM transmitter.





It's the 1000-mile Trans-Arabian Pipeline's desert marvel, TAPLINE . . . RCA radio equipped

From Persian Gulf to Mediterranean Sea . . . across more than a thousand miles of shifting sands and rugged desert . . . runs TAPLINE, one of the world's greatest oil-carrying systems, built by Trans-Arabian Pipeline Company.

Tribute to the engineering resourcefulness of many organizations, TAPLINE takes its place as a marvel of modern vision and commercial achievement. RCA engineers were among the first in the field, in 1947 . . . to provide radio

communication as the oil line was built.

The great system, now in complete operation, is RCA radio equipped. Desert vehicles receive and transmit with mobile radio units of new design. Aviation radio directs air traffic serving TAPLINE. Marine radio aids tankers off shore. Fixed control and relay stations, that operate in all the weather of 1000 desert miles, keep up the flow of radio communication that is vital to the flow of oil.

RCA's experience in radio is world-wide. Its equipment is recognized as the standard for highest performance. The international facilities of RCA are ready to help industry or government in all fields of radio. Consult your RCA distributor or RCA International Division.

The interesting booklet "Sand, Oil and Radio," the story of TAPLINE, may help you. It is free. Simply write for it.



RCA INTERNATIONAL DIVISION
RADIO CORPORATION of AMERICA
RCA BUILDING
30 ROCKEFELLER PLAZA, NEW YORK, N.Y., U.S.A.

Field Engineering Service to Broadcasters...AM, FM, TV



RCA Service Company engineers are experienced in all the latest techniques and are equipped with the most modern specialized measuring equipment. The RCA Service Company has been working hand in hand with the nation's broadcasters for over 25 years.

OUR SERVICE TO BROADCASTERS

- Installation supervision and measurements of transmitting, studio and accessory equipment . . . AM, FM or TV.
- Instruction and training of station operating personnel.
- Measurement and curves on FM and TV antennas and accessory equipment, including transmission lines, matching networks, diplexers.
- Prompt help in emergencies. Technical advice, service, and assistance on special problems.
- Performance measurements and adjustments for station compliance with FCC regulations.

For further information call or write Communications Service Section, RCA Service Company, Inc., Camden, N. J.

(For service outside the U. S. A., consult your Authorized RCA Distributor)

NOW—restore the original quality of your RCA microphones, transcription pick-ups and test and measuring equipment under the new Factory-Reconditioning Plan. For complete details, write: Return Apparatus Control, Building 8-2, Camden, N. J.



RCA Service Company, Inc.
A Subsidiary of the Radio Corporation of America
CAMDEN, NEW JERSEY



how **RCA** **2-WAY** **RADIO**

BOOSTS SAFETY

CONSERVES RESOURCES

STRETCHES BUDGETS

... an illustrated fact-book about 2-way radio in public-safety services. Tells "how-it-works" and "how-to-use-it" in easy, straightforward terms.

... shows how RCA 2-way radio speeds law enforcement, fire-fighting operations. Describes municipal and state communication networks. Illustrates use in forestry conservation, flood control, game-law enforcement.

In highway maintenance, it shows how RCA 2-way radio can speed operations... cut costs. There is even information about civil defense...

disaster relief... school bus co-ordination... ambulance dispatching... physicians and veterinarians.

It explains RCA's consultation service... its maintenance plan... tells how RCA helps plan the best 2-way radio system for your needs... how to obtain frequency assignments... FCC Construction Permits.

The "must" reference book for each and every man in public-safety services. For your copy, mail the coupon. (In Canada, write: RCA Victor Limited, Montreal.)



RCA ENGINEERING PRODUCTS
Dept. 129-1
Camden, New Jersey

Send me a free copy of "2-way Radio for Public Safety."

Name _____ Title _____

Firm _____

Address _____

City _____ State _____



RADIO CORPORATION of AMERICA

Navy's Most

Supervisory Control Console for the U. S. Navy's million-watt radio-telegraph transmitter.

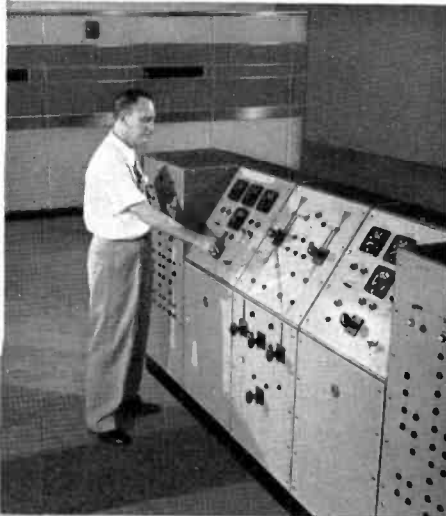

**Million-Watt Radio-
Telegraph Transmitter
now being installed**



Powerful...!

Here is the most powerful radio-telegraph transmitter ever built for the United States Navy. Signals from this super-power station will provide world-wide coverage.

The new million-watt transmitter is designed to provide communication with the U. S. Fleet even when other radio services are blacked out by magnetic and ionospheric disturbances. Naval communications service requires posi-

tive direct transmission to mobile forces at sea or in the air, wherever they may be.

This powerful transmitter was built by RCA to Navy specifications. It incorporates several outstanding technical achievements in transmitting gear of this type and power. Unique features include: variable frequency control . . . electron tubes with power gains of 250 . . . fault protection which acts with-

in ten-millionths of a second . . . and provisions for frequency-shift teletype signalling.

• • •
The engineering, manufacturing and service activities of RCA embrace all phases of the electronic and communication fields on land, sea and in the air. RCA, through its vast facilities, is constantly striving to provide our armed forces with better military equipment.



RADIO CORPORATION of AMERICA
ENGINEERING PRODUCTS DEPARTMENT

CAMDEN, N. J.

America's TOP Independent

for instance

WPIX

WPIX is reaching more millions from its new station atop the Empire State Building in New York City.

Already recognized as a leader in sports programs and news remotes in the New York Metropolitan area, WPIX is now delivering a new, improved visual and aural service to the largest TV audience in the world—from the tallest television tower in the world!

"Individual" planning by one of television's top engineering staffs demonstrates a new technique in TV operation—used for the first time by any station.

New transmitter room on the 81st floor of the Empire State Building. Everything is RCA.

TV Stations are RCA-Equipped...

... with two complete transmitter rooms and two independent antennas

WPIX backs its operations with two completely independent transmitter-and-antenna systems on two different sites.

Regular "on-air" service is handled by the Empire State plant. Emergency "on-air" service is handled from the original installation in the building of the New York Daily News.

WPIX uses RCA equipment throughout both stations. For example, two independent transmitter rooms—with all

associated equipment. Two independent antenna systems. Field equipment—including micro-wave relays. Remote video relay switching. Studio control-room equipment. Control consoles, amplifiers, sync generators, power supplies.

When you plan your TV station, or add facilities to your present operation, talk it over with your RCA Broadcast Specialist. He can tell you exactly what you need to do the job at minimum cost.

6-bay RCA Superturnstile antenna on the New York Daily News Building—a completely independent standby radiating system for emergency operation.



RADIO CORPORATION of AMERICA
ENGINEERING PRODUCTS DEPARTMENT CAMDEN, N. J.

Standby station of WPIX, complete with RCA 5-kw TV transmitter, control console, antenna diplexer, vestigial sideband filter, dummy load.

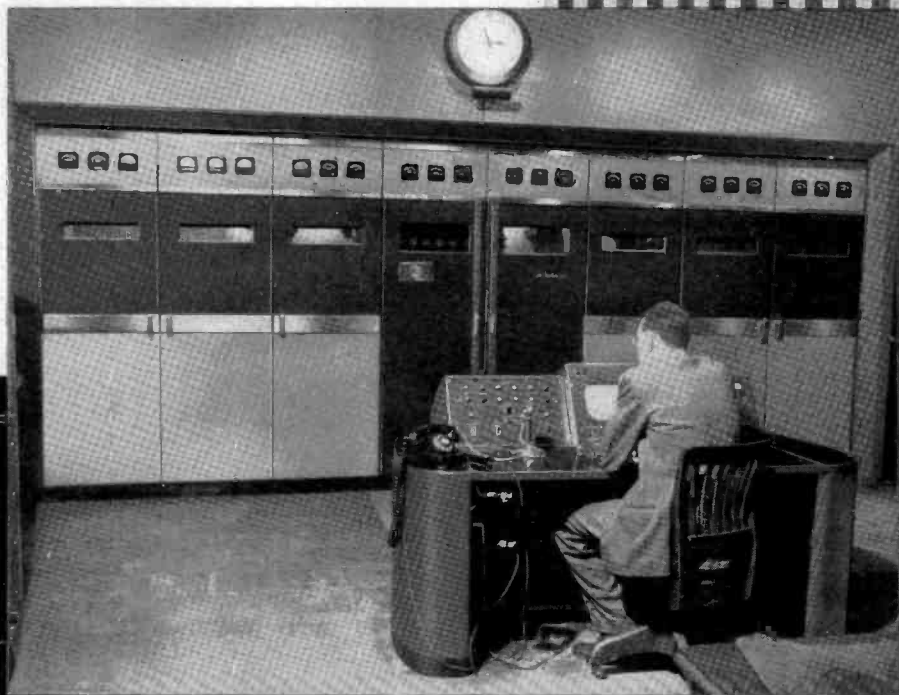

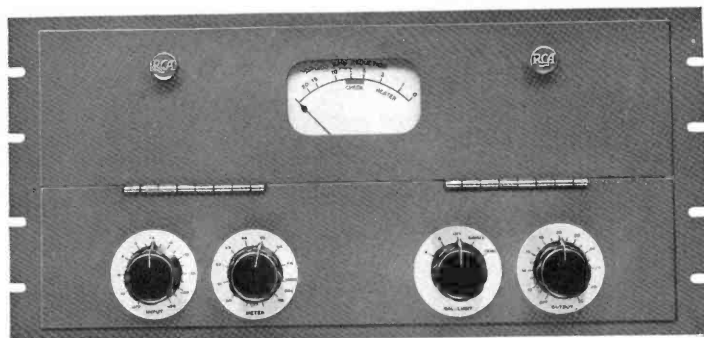

All new

RCA Limiting Amplifier BA-6A

For high-fidelity AM and FM speech input systems

FEATURES

- No matched tubes required
- Choice of single or dual time constant
- Greater reliability—push-pull stages throughout
- High gain—Low noise level
- Adjustable T-pad in output
- Standard plug-in mounting—for new handling convenience

SPECIFICATIONS

- Output level at verge of limiting, 30 dbm
- Gain, 54 db
- Noise level—down 83 db at verge of limiting
- Frequency response ± 1 db, 30-15,000 cycles
- Distortion (12 db gain reduction), 1%
- Takes only $8\frac{3}{4}$ inches of rack space. Weighs only 37 pounds.

This represents the ultimate in useful performance...at lower cost



AUDIO BROADCAST EQUIPMENT
RADIO CORPORATION of AMERICA
ENGINEERING PRODUCTS DEPARTMENT, CAMDEN, N. J.

In Canada: RCA VICTOR Company Limited, Montreal

Save yourself hundreds of dollars when you buy your limiting amplifier BA-6A. For complete details, call your RCA Broadcast Sales Engineer. Or write Dept. PA-19, RCA Engineering Products, Camden, N. J.





*For TV
station planners*

... from your
nearest **RCA**

Sales Representative



**TELEVISION TRANSMITTER
and ANTENNA EQUIPMENT**

(V-H-F and U-H-F)

for Any Radiated Power to 200,000 Watts
Channels 2 to 83



This 64-page book is prepared specifically for TV station management, chief engineers, architects, consultants, and attorneys connected with station designing, planning, building, and operating. In a single reference it contains concise descriptions of RCA's entire line of TV transmitter and antenna equipment—including transmitter plans and layouts, general application data, and cost charts.

For your copy, get in touch with the RCA Broadcast Sales Representative nearest you:

New York 20, N. Y.
36 W. 49th Street
Telephone: Circle 6-4030

Dallas 1, Texas
1907-11 McKinney Ave.
Telephone: R-1371, 1372, 1373

Cleveland 15, Ohio
718 Keith Building
Telephone: Cherry 1-3450

Atlanta 3, Ga.
522-533 Forsyth Bldg.
Forsyth and Luckie Streets, N. W.
Telephone: Walnut 5946

Kansas City 8, Mo.
221 W. 18th Street
Telephone: Victor 6410

Hollywood 28, Calif.
1560 North Vine Street
Telephone: Hollywood 9-2154

San Francisco 3, Calif.
1355 Market Street
Telephone: Hemlock 1-8300

Chicago 11, Ill.
666 North Lake Shore Drive
Telephone: Delaware 7-0700

Washington 6, D. C.
1625 K Street, N. W.
Telephone: District 1260



RADIO CORPORATION of AMERICA
ENGINEERING PRODUCTS DEPARTMENT
CAMDEN, N. J.



FAITHFUL SERVANTS of AM Broadcasting

BY FAITHFULLY SERVING the important requirements of AM broadcasting, RCA tubes have won an unqualified reputation for engineering excellence, dependability, and true operating economy.

In the future, as in the past, AM broadcasters can look to RCA for the finest in power tubes. RCA consistently follows a program of developing new AM tube types and of improving earlier AM types. *For example:*

RCA 892-R—The forerunner of a group of RCA-designed air-cooled power amplifier tubes that simplified transmitter construction and introduced new operating and maintenance economies. Today, hundreds of these tubes are demonstrating their long life and dependability in the nation's leading 5- and 50-kw AM transmitters.

RCA 833-A—Originally designed by RCA engineers, this power triode features a giant zirconium-coated anode for greater dissipation, shielding that eliminates bulb bombardment, and a husky filament that has tremendous emission reserve for peak loads. These features have contributed to more dependable operation, longer service life, and greater operating economy.

RCA 5671—A recent addition to the RCA line, this power triode with its *thoriated-tungsten filament draws 60 per cent less filament power* than the previous pure-tungsten-filament type . . . making possible a saving of \$1200 or more a year in filament power in standard 50-kw AM transmitters. *Performance-proved in the field.*

✓ **A REMINDER**—RCA tubes for all types of broadcast service are available from your local RCA Tube Distributor or direct from RCA.



RCA LABORATORIES
PRINCETON, N. J.

THE FOUNTAINHEAD OF MODERN TUBE DEVELOPMENT IS RCA



RADIO CORPORATION of AMERICA
ELECTRON TUBES
HARRISON, N. J.