

AM · FM · TELEVISION

BROADCAST

NEWS

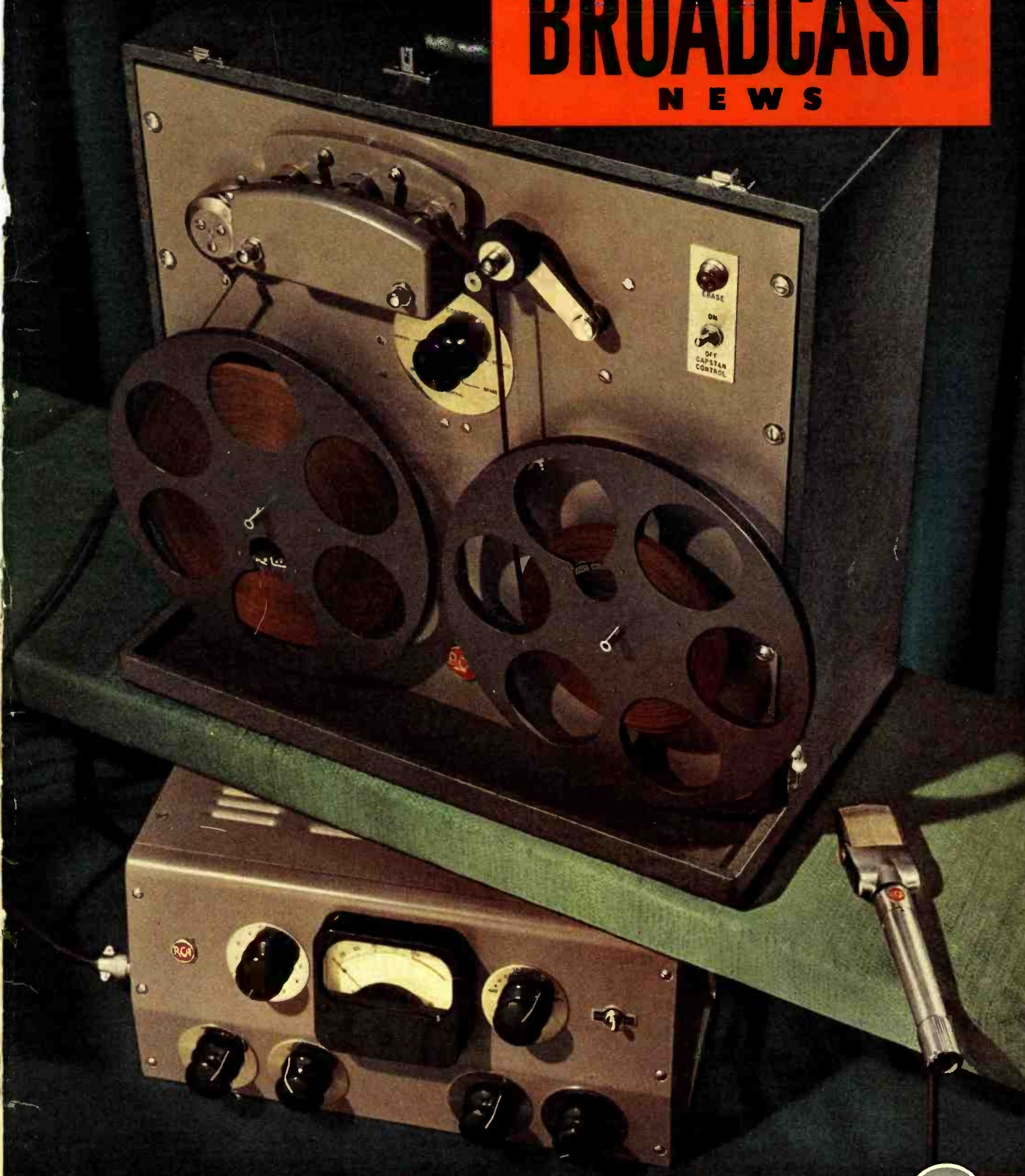

NEW TAPE RECORDER Details on pg. 6





*The one company that
has everything for
every broadcaster*

AM

FM

TV

**At each of the following locations you
will find a broadcast specialist who is
ready to help you with your problems:**

36 W. 49th Street
NEW YORK 20, N. Y.

718 Keith Bldg.
CLEVELAND 15, OHIO

666 N. Lake Shore Drive
CHICAGO 11, ILLINOIS

1625 "K" Street, N. W.
WASHINGTON 6, D. C.

522-533 Forsyth Bldg.
Forsyth and Luckie Sts., N. W.
ATLANTA 3, GEORGIA

221 W. 18th Street
KANSAS CITY 8, MO.

1907-11 McKinney Avenue
DALLAS 1, TEXAS

1355 Market Street
SAN FRANCISCO 3, CALIF.

1560 N. Vine Street
HOLLYWOOD 28, CALIF.

Harper-Meggee Bldg.
Republican and Terry, N.
SEATTLE, WASH.



**BROADCAST EQUIPMENT
RADIO CORPORATION of AMERICA
ENGINEERING PRODUCTS DEPARTMENT, CAMDEN, N.J.**

In Canada: RCA VICTOR Company Limited, Montreal

Broadcast News

AM • FM • TELEVISION

Published by the

RADIO CORPORATION OF AMERICA

ENGINEERING PRODUCTS DEPARTMENT . . . CAMDEN, NEW JERSEY

NUMBER 54

APRIL, 1949

Subscription Rate \$2.00 per year.

Single copy 50c.

JOHN P. TAYLOR, Editor

JUDY J. ALESI, Ass't Editor

W. O. HADLOCK, M. L. GASKILL, Associate Editors

Contents

THE NEW PORTABLE TAPE RECORDER	by W. E. STEWART	6
WENR-TV	by E. C. HORSTMAN AND J. M. VALENTINE	14
TELEVISION FILM RECORDING	by R. V. LITTLE, JR.	32
THE PHILOSOPHY OF OUR TV SYSTEM (Part II)	by JOHN H. ROE	37
RCA COMPLETES SIXTH TV CLINIC		43
WCAU-TV	by JOHN G. LEITCH	52
HOW TO GET THE BEST PICTURE OUT OF YOUR IMAGE ORTHICON CAMERA	by H. KOZANOWSKI	74
THE "BERKSHIRE"—A RADIO-PHONOGRAPH BUILT TO TRANSMITTING EQUIPMENT STANDARDS	by MARVIN HOBBS	78

Copyright
Radio Corporation of America
RCA Victor Division
Camden, N. J.

PRINTED
IN
U.S.A.

OUR COVER for this issue, as you have long ago discovered, is reproduced from a color photo of the portable model of the new RCA Tape Recorder. This recorder, designed especially for broadcast station use, has been a long time in the works. Tape recording is a relatively new field—it took time to design, test, and take the bugs out of this new unit. But it's here now—and you'll find it worth the wait.

Those of you who read this at the NAB Convention can see the new recorder in operation in our exhibit space. Those less fortunate can get a relatively quick look at one by ordering now. Deliveries start June 1 for the early birds.

KINEPHOTO equipment also comes in for attention in this issue. The article by Ralph Little, starting on Pg. 32, describes the Type TMP-20B Kinescope Recording Equipment which RCA engineers have developed specifically for TV station use. Pre-production models of this equipment, which is suitable for use with either the single (simultaneous sound and picture) or the double (separate sound) method of recording, have been tested by all three of the networks with relatively good results. Although there is still considerable difference of opinion as to the extent to which kinescope recordings will ultimately be used, there is no doubt in anyone's mind that they will have an important place—a place which will equal, some believe, the place of transcriptions in sound broadcasting.

First shipments of Type TMP-20P Recorders from regular production are just now beginning. Those of you attending the NAB Convention can see this equipment in full scale operation in our exhibit space. Those who miss it there can see it in New York at the ABC, CBS, or NBC studios.

TV STUDIO MODELS, not one, but four, will be another interesting feature of our exhibit. These models—representing four different sizes of stations, from "acorn" to "network key"—have been very carefully worked out. They are accurately scaled and all of the equipment units are represented by scale models arranged as suggested by the best brains in the business. If you have TV layouts on your mind, don't fail to see these models. And if you get ideas about having a model of your own dream station—well, maybe we can help you.

5 KW FM TRANSMITTER, a new and rather hot item will also be on display. This transmitter solves the problem of the station that can't quite get 20 KW—or whatever your ERP is—with a 3 KW transmitter, but hesitates about jumping to a 10 KW. With a 4-section Pylon (gain of 6) this transmitter will give you an ERP of 30 KW (less line loss). With an 8-section Pylon (gain of 12) you can have 60 KW ERP (less line loss). That's a lot of radiation for the money.

WCAU-TV story (Pg. 52) hits a new high in TV station stories. Here is a station that was planned by men whose experience encompasses the whole life span of broadcasting, equipment installed the way every station engineer would like to install a station, and an operation which in a year has overtaken and leapfrogged most of the field. But you don't have to take our word for it. Read the story yourself—you'll find there's conviction in every word of it—and a lot of tips for all new TV starters.

WENR-TV story (Pg. 14) is another swell one. Here is a station which was installed in a tremendous hurry, took the air under great pressure, and has operated that way ever since. Are the "weener" boys a harried lot? Not a bit of it. This crew, under Ed Horstman, ABC's Central Division Engineer, is doing an outstanding job without getting the least excited about it. They say their RCA equipment is performing beautifully and that it's flexible enough to do almost anything the program department can dream up—so why worry. Okay by us, boys—and thanks for the plug. Oh yes, we almost forgot, a trip to WENR-TV is on the NAB Engineering Program. Don't miss it—this is worth seeing—and their hospitality—peace, it's wonderful!

World's first super-power

all three... use **RCA 50-kw's**



SUPER-POWER FM STATION WTMJ-FM, MILWAUKEE.
Operates an RCA BTF-50A FM transmitter in conjunction with a high-gain antenna. Total effective radiated power, 349 kw—on 93.3 Mc!



SUPER-POWER FM STATION WBRC-FM, BIRMINGHAM.
Operates a type BTF-50A FM transmitter in conjunction with an RCA 8-section Pylon—880 feet above average terrain. Total effective radiated power, 546 kw—on 102.5 Mc!



SUPER-POWER FM STATION WMCF, MEMPHIS.
Operates an RCA BTF-50A FM transmitter in conjunction with an RCA 4-section Pylon antenna mounted on a 750 foot tower. Total effective radiated power, 260 kw—on 99.7 Mc!

THESE PIONEER STATIONS are making FM service over wide areas a PRACTICAL REALITY—*with the world's first commercial 50-kw FM transmitter, the RCA BTF-50A!*

This is the transmitter that makes it possible to link 50 kilowatts of FM power to a high-gain Pylon antenna and deliver up to 600 kilowatts of effective radiated power—enough radiated power to serve primary areas out to 200 miles radius from mountain elevations.

Here are some of the transmitter features:

50,000 watts output on any specified frequency in the 88-108 Mc band. Grounded-Grid amplifiers and simplified single-end r-f circuits (all class C) for extreme stability and easy tuning. Direct FM

to give high-fidelity FM simply and directly (less than 1% output distortion over the range of 30-15,000 c.p.s.). Only 43 tubes in the entire transmitter—and emergency operation may be maintained with only 24 tubes. *Only 16 different tube types all told.* One high-voltage supply for all high-power needs. Hi-lo power switching for emergency 8-kw operation. Complete air-cooling . . . using two independently-operated blowers.

. . .

Type BTF-50A . . . *immediately available from stock* . . . can be used with an RCA FM Pylon to improve your station coverage *materially*. For the facts, see your RCA Broadcast Sales Engineer. Or write Dept. 28B, RCA Engineering Products, Camden, N. J.



FM's...



Ready to ship

RCA 50-KW FM Transmitter, Type BTF-50A. Easiest-handling high-power transmitter ever built—with handsome unified front-panel design that

fits any station layout. BTF-50A transmitters are delivered with pre-emphasis network, harmonic attenuator, transmission line monitor, power cut-back and supervisory console.

Transmitter photo by courtesy
WBRC-FM, Birmingham, Alabama.



BROADCAST EQUIPMENT
RADIO CORPORATION of AMERICA
ENGINEERING PRODUCTS DEPARTMENT, CAMDEN, N. J.

In Canada: RCA VICTOR Company Limited, Montreal

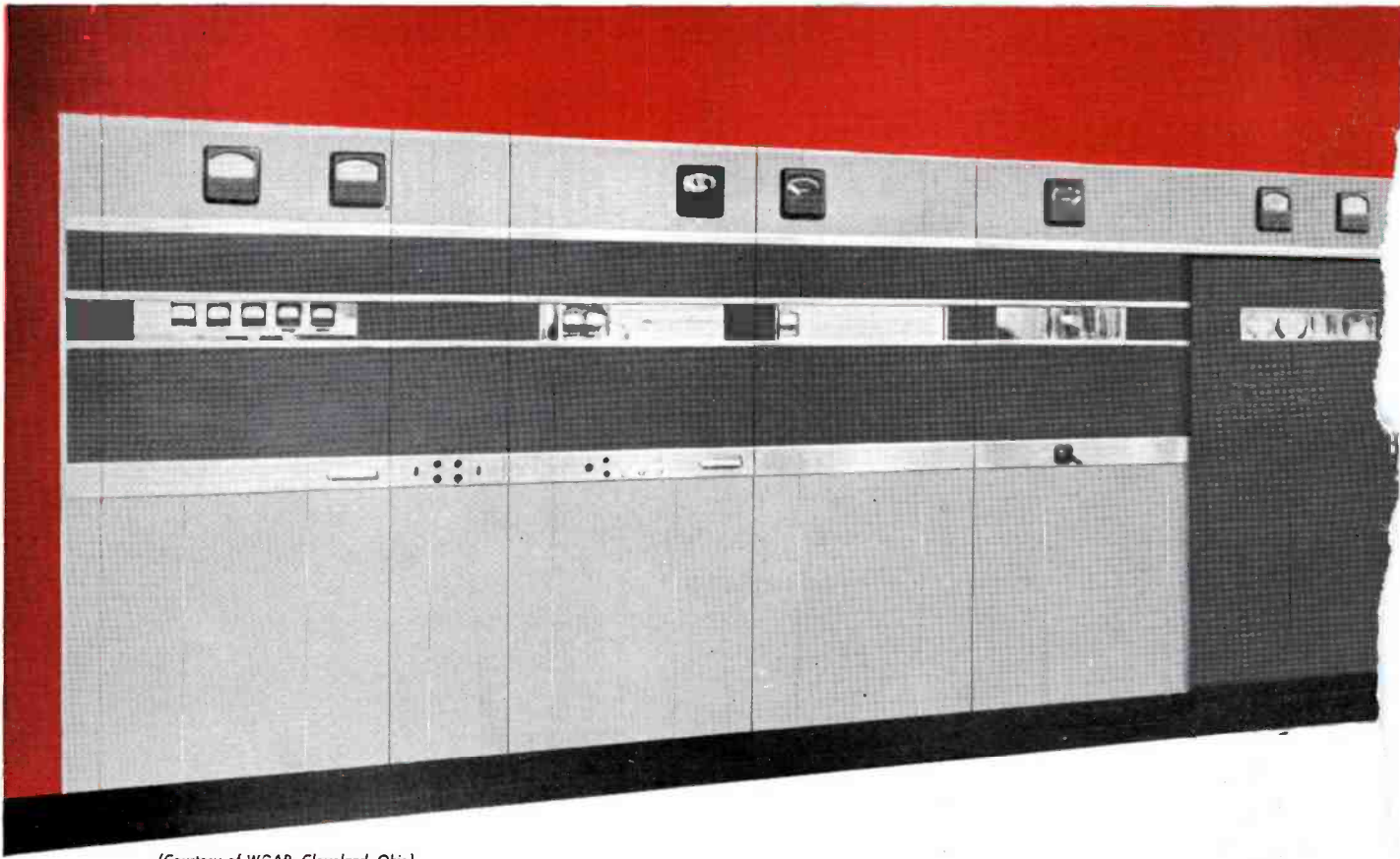

(Courtesy of WGAR, Cleveland, Ohio)

Replace your old AM transmitter *with RCA's new 50 kw...*



The revolutionary, new power triode RCA-5671. This tube takes about one-third the filament power of conventional triodes used in the older transmitters. It reduces hum modulation below FCC requirements—even without r-f feedback.

The two 5671's in the r-f power amplifier and the two in the class B modulator of this 50-kw transmitter save up to \$1200 yearly in filament power alone.



The finest transmitter ever built... the RCA type BTA-50F1. It takes less than 100 kilowatts of power to run it. The supervisory control console is standard equipment!

Today more than 50 RCA "Fifties" have been shipped!

and write off its cost in power savings alone!

It's a fact—as one high-power broadcaster recently discovered to his complete satisfaction. Now, he has replaced his old transmitter with an RCA "fifty"—and it's paying its way.

HERE'S WHY.

Using revolutionary new RCA-5671 power triodes that take about one-third the filament power of conventional types, this RCA "fifty" saves up to \$1.75 an hour in power savings over former transmitters—\$12,000 a year, based on daily operation at 19 hours a day!

Many other new design features, too, that add to this \$12,000 savings.

For example, only 29 tubes and 11 different tube types—less than half the number used in many present 50 kw's. True walk-in accessibility that assures faster maintenance—and lowers maintenance costs. Ultra-conservative operation of tubes and components—with less chance for outages.

Here is a 50-kw AM transmitter that does away entirely with oil circuit breakers—assures faster circuit protection. Because the BTA-50F1 operates from a 460-volt supply. Control and protection

circuits are the most complete of any transmitter designed to date. And its true unified front (an integral part separate from compartment enclosures) facilitates flush-mounting—gives your transmitter room a new, handsome appearance.

Write for the new 28-page brochure about the BTA-50F1. It gives you complete details—including circuits, specifications, floor plans, and full-page pictures showing the remarkable accessibility of this great transmitter.

Dept. 19HC, RCA Engineering Products, Camden, New Jersey.



BROADCAST EQUIPMENT
RADIO CORPORATION of AMERICA
ENGINEERING PRODUCTS DEPARTMENT, CAMDEN, N.J.

In Canada: RCA VICTOR Company Limited, Montreal

THE *New* PORTABLE TAPE RECORDER

. . . with studio performance

By

W. E. STEWART

Audio Engineering Section

Engineering Products Department

General Description

The new RT-3A portable magnetic tape recorder is designed to fulfill the broadcasters' needs for a lightweight, low cost recorder with true studio quality. Incorporating a smooth, two-speed, synchronous motor drive, the RT-3A is well suited for recording programs at remote points with

the same high fidelity that is possible in the studio. The advantages of simplicity and ease of recording, long playing, easy editing are equally desirable for all applications. The RT-3A is a complete recording system consisting of an amplifier unit and recording unit plus necessary interconnecting cables. The amplifier unit includes a recording amplifier, playback amplifier and "erase" and bias oscillator.

The recorder proper includes motor board, capstan drive, magnetic recording head plus all necessary controls which are front-panel mounted for easy access. Two recording speeds (15 in./sec. and 7.5

in./sec.) are provided. With the tape speed set for 15 in./sec. the reels hold sufficient tape for 33 minutes of continuous recording with 15 KC response, and by the simple flip of a switch it is possible to change the tape speed to 7.5 inches-per-second (with 7 KC response) which provides sufficient tape for over an hour of recording. The speed-control switch also automatically applies the proper compensation for both response positions.

The reel shafts are of the proper size to accommodate RMA proposed standard reels which are in use on many recorders today, as well as the regular larger reel.

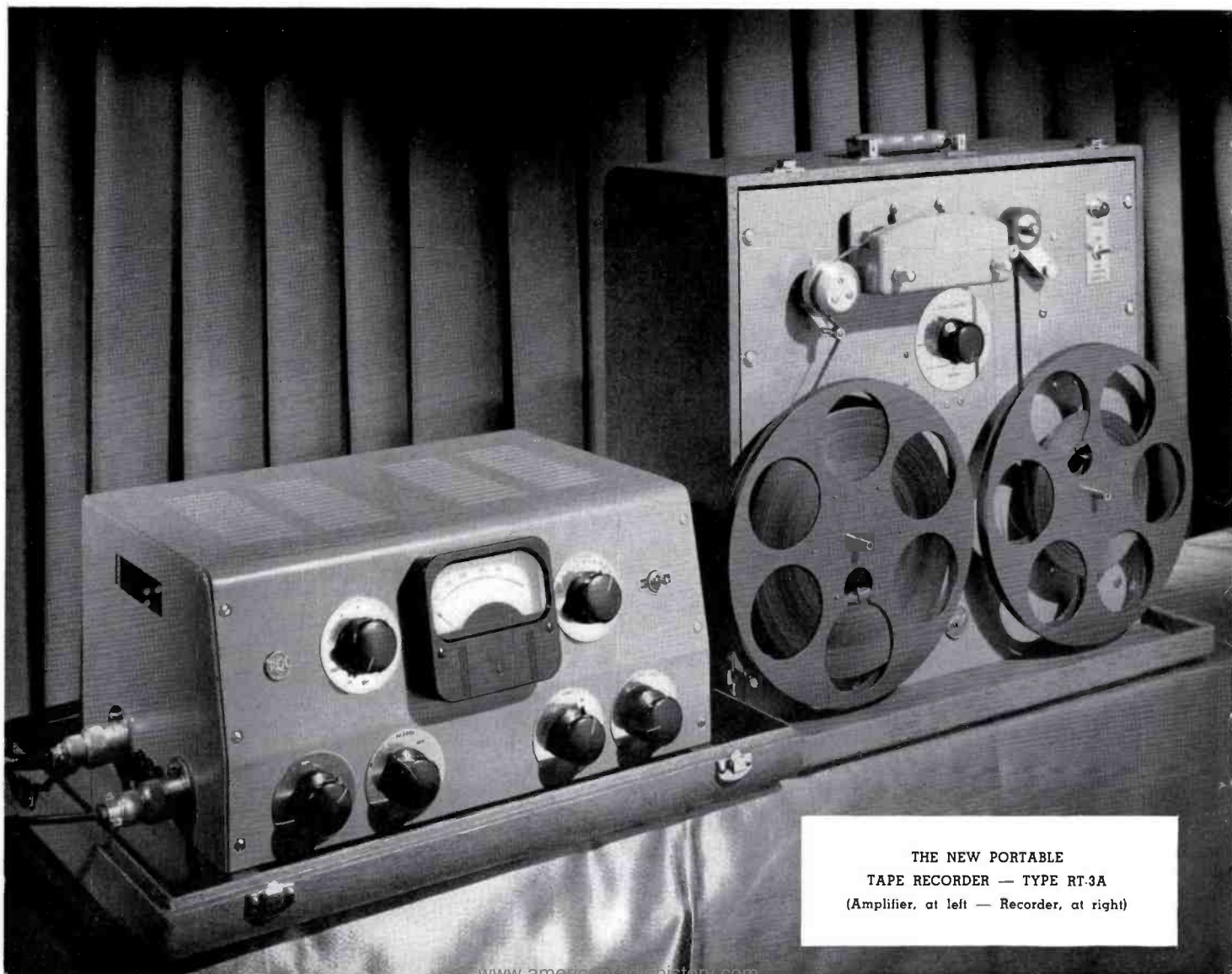

THE NEW PORTABLE
TAPE RECORDER — TYPE RT-3A
(Amplifier, at left — Recorder, at right)

With this smaller "RMA" reel, there will be room for a half hour recording at 7.5 inches-per-second tape speed.

THE AMPLIFIER UNIT

Recording Amplifier

The entire RT-3A amplifier is contained in a separate carrying case which also has room for the connecting cords, reels, etc. Cannon quick-disconnect plugs and receptacles are used. The recording amplifier circuit has sufficient gain to operate directly from a microphone input. Impedances and levels are correct for matching the new BN-2A Remote Amplifier, or the OP-7 Mixer Preamplifier, if more input channels are required. Also line terminals and a pad are built in the amplifier so that recordings may be taken directly from a 600-ohm line, when desired.

An input gain control is provided at the grid of the first tube, and three stages of amplification using 1620 and 6J7 tubes are provided with feedback applied to reduce distortion. It is not possible to express amplifier operation strictly in the usual terms of gain, since the input is normally measured in volts and the output in current supplied to the recorder head. Using a constant voltage input to the amplifier, the output current to the recorder head follows the characteristics shown in Fig. 4. The motor-selector switch changes speed and amplifier recording characteristic simultaneously, so that it is not necessary for the operator to give any thought to the proper compensation curves.

Although there has not yet been a standard recording curve recommended by the NAB, the curves in Fig. 4 are based on extensive laboratory work and represent favorable conditions for the usual broadcast program material. Other compensation curves may be obtained by the change of a few simple R-C components.

The tube cathode currents may be observed with the VU meter furnished by simply throwing a meter switch. The VU meter can also be switched to the recording circuit for measuring recording levels.

FIG. 4 (at right). Recording pre-emphasis curves for 7.5 inches per second and 15 inches per second tape speeds.

FIG. 2 (at right). Both units (recorder and amplifier) are easily portable for use on remote recordings. Recorder is being carried in operator's right hand—amplifier in his left hand.



FIG. 3 (below). The RT-3A amplifier unit with top cover removed to illustrate accessibility of all parts and tubes. Note that only high-quality broadcast type components are used throughout.

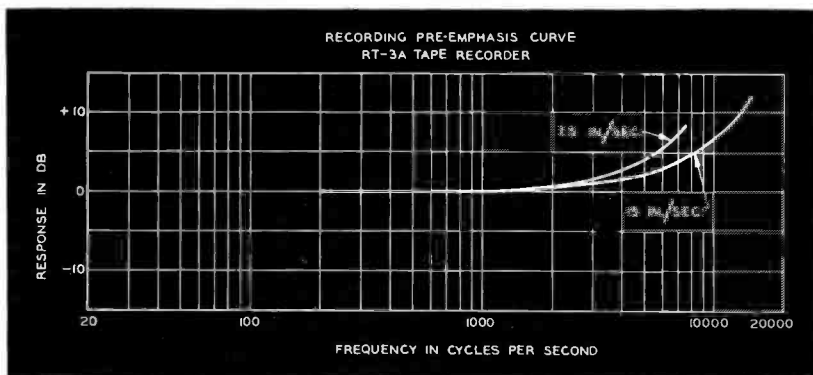

"Erase" and "Bias" Oscillator

A single oscillator circuit supplies both "erase" and "bias" voltages. The oscillator frequency is set at approximately 100 KC so that it is well above all audio frequen-

cies. "Erase" and "bias" voltages are independently adjustable and can also be checked with the VU meter.

A calibration potentiometer is provided so the bias setting may be accurately

adjusted and "zeroed" with the VU meter. The calibrated scale makes it easy to observe the exact original setting, in the event it is found desirable to make a later recheck. However, these adjustments normally remain quite stable and seldom require change. With the "Record" knob in "Off" position, the recording head and the output of the recording amplifier are short-circuited and the plate power supply is disconnected from the oscillator and recording amplifier. Thus, accidental erasing or recording is not probable. A pilot light on the recorder panel is operated by the "erase" current and gives a positive indication that the controls are in the position for recording.

Playback Amplifier

The need for "blind" recording by the operator is eliminated through the unique design of the RT-3A amplifier unit. It incorporates a separate playback and recording amplifier, thus enabling recording and simultaneous monitoring of the recorded program—which assures the operator that all equipment is functioning properly.

The playback amplifier circuit consists of three stages of amplification (type 1620 and 6J7 tubes are used). Compensation to obtain the proper response from the pickup head is provided in the feedback circuit of the first stage, and is changed automatically by the "speed-selector" switch. Like the recording characteristic, it is easily altered by a simple change of R-C components. A gain control is employed between the 1st and 2nd stages and amplification is sufficient to feed a line level of +18 dbm. The front-panel VU meter can be "switched-in" to meter the cathode currents, or measure the output level across the line. Suitable binding posts are provided for line connections and a headphone jack for monitoring.

THE RECORDER UNIT

Synchronous, Two-speed Motor

A unique mechanical arrangement using a single motor provides convenient functioning of the recorder without sacrificing compactness and portability.

Recorder design includes a hysteresis type synchronous motor with two windings so that the speed may be changed from 3600 to 1800 rpm by the speed selector knob on the amplifier front panel. It is this design feature which makes possible instant change of speed and compensation simultaneously and eliminates mechanical speed change devices.

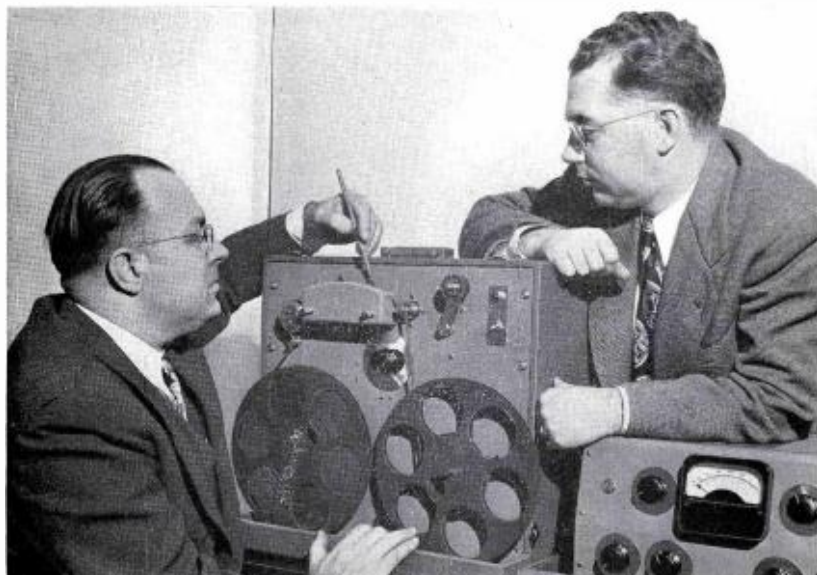

FIG. 5 (above). W. E. Stewart, RCA Broadcast Audio engineer, points out features of plug-in recorder head assembly to W. L. Babcock of Broadcast Equipment Sales.

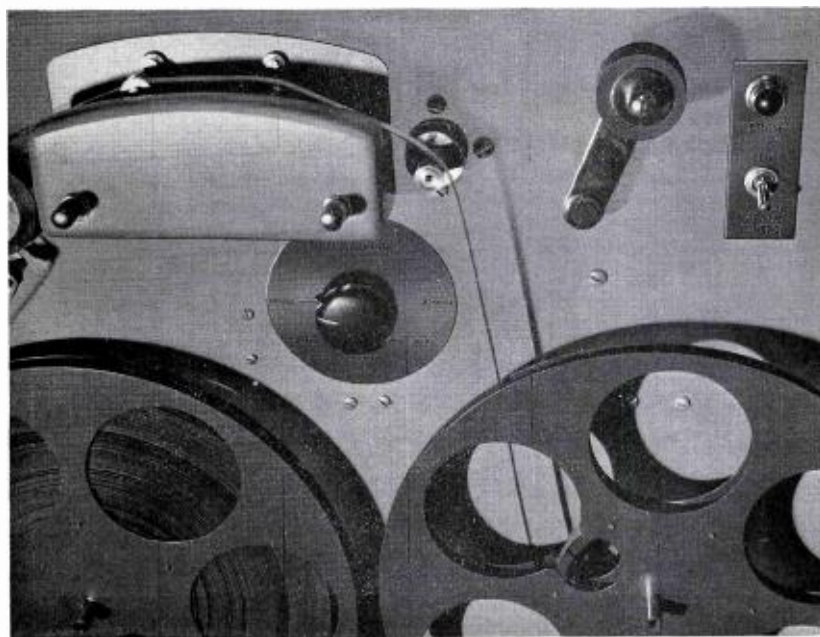

FIG. 6 (above). In this closeup view of the recorder, the stabilizer is partially visible at extreme left—with recorder head assembly adjacent, and capstan drive at right-hand end of head assembly. Note that pressure roller (in upper right of photo) is raised for a fast rewind operation.

Automatic Torque Adjustments

The motor maintains proper torque on both the "supply" and "take-up" reels through a horizontal belt and friction drum arrangement in which the drums float on the belt, and the weight of the tape on the reels applies essentially constant tension to the tape. Normal tape tension of the RT-3A is such that head wear is extremely slow and long life is realized. A knob near the center of the front panel will lift either reel off the belt and depress the opposite reel in order to provide a fast "forward" or "reverse" wind. The same adjustment knob is used to lift the pressure roller off the capstan drive during these operations. Braking positions are provided to avoid snarling the tape at the end of a fast winding operation. It is not necessary to operate the capstan control during rewind operations, since a cam switch automatically energizes the motor. In the neutral position of the rewind knob, the motor is turned "off," and the mechanism is ready for operation (at recording speeds) from the capstan control. "Rewind" of the entire reel of tape can be completed in less than three minutes.

The use of two-sided reels mounted in a vertical position avoids possibility of accidents in which tape might become tangled due to unskilled winding or accidental misalignment. It also reduces the possibility of an idle reel unwinding several turns when the tension is slack; such as might otherwise occur when a loaded reel is placed on the hub, but not yet threaded.

Stabilizer

The stabilizer is an inertia device which smooths out tape-tension variations coming from the supply reel. It is a ball bearing arrangement in which all rotating parts are held to very close tolerances in order to give the smoothest possible action, and avoid irregularities due to eccentricities. A fly wheel on the rear end of the shaft provides the necessary inertia.

Capstan Drive

Capstan drive is accomplished through another belt coupled to a heavy fly wheel on the rear of the capstan shaft. A ball bearing carries the weight of the fly wheel, while a sleeve bearing at the tape end assures smooth tape drive. Comparatively slow shaft speeds allow the capstan to be large enough to minimize the effects of eccentricity.

Quick Threading of Tape

The tape path leads from the "supply" reel on the left of the recorder unit through a stabilizer (see Figs. 6 and 7) to the recording heads, then over the capstan drive to the "takeup" reel. This arrangement makes tape threading a simple process which may be completed within a few seconds. During threading, the recorder rewind-knob is placed in the neutral position with the capstan roller up—and capstan switch "Off". After positioning the

reels, threading consists of simply placing the tape over the stabilizer, recorder head assembly, and capstan. The capstan pressure roller is then lowered on the tape, and the equipment is ready for recording.

Recorder Head Assembly

The magnetic recorder head assembly is one of the most important items in the machine, since it is the point at which erasing, recording, and reproducing take place.

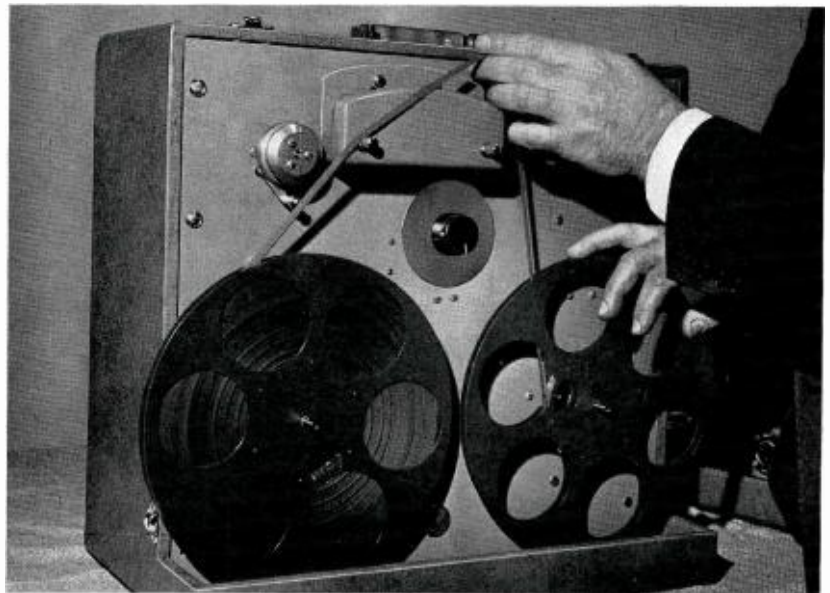

FIG. 7 (above). Threading is quickly and easily accomplished in a matter of a few seconds. Operator simply lifts tape with forefingers over the capstan, recorder heads and stabilizer in one operation.

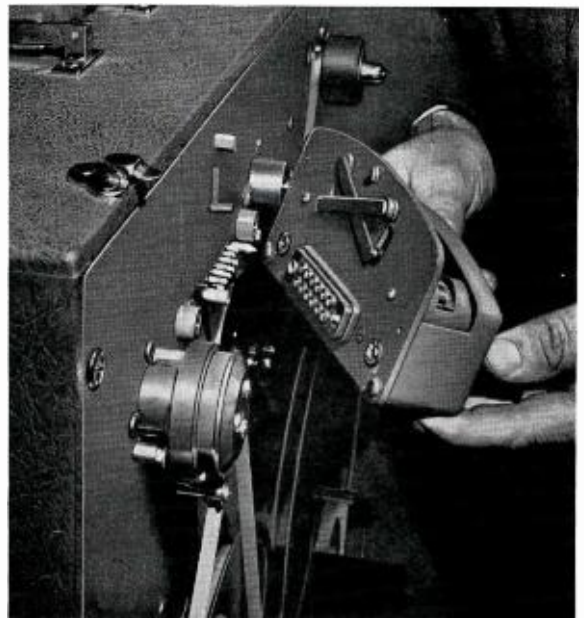

FIG. 8 (at right). The single 3-unit plug-in head assembly is simple to remove as illustrated here. High grade, silver-plated, self-ejector type connectors insure positive contact and easy removal.

The 3-unit head assembly is a convenient, compact plug-in arrangement. Two thumb screws loosen the entire assembly and ejector springs force the contacts apart, so that no pulling or prying of the head assembly is necessary. Carefully placed positioning pads assure exact re-alignment when the assembly is replaced. Under the outer cover, which serves as a magnetic shield, are the three heads which are mechanically similar, however, they differ in important details.

The "erase" head is on the extreme left where the tape travels over it first. A 100 KC signal from the amplifier supplies this head with erasing current. An adjustment for this current is readily accessible in the amplifier and erase current

can also be checked by the VU meter on the amplifier and the pilot light on the recorder. This current adjustment is not critical, nor is the adjustment of the magnetic gap in the core, or the azimuth alignment. The "erase" head is shielded with copper to reduce external fields from the 100 KC signal. The winding is low impedance and a wide gap is used for efficient erasing.

The "record" head is in the middle of the recorder head assembly. It serves the important function of placing the program on the tape. The edge of the gap in the magnetic core must be a straight line, so that the recording is always placed properly on the tape. It is also important that the core gap be exactly at right angles to

the motion of the tape. (This is further explained in a paragraph below.) The program from the recording amplifier is applied to the recording head through a matching transformer (high frequencies are somewhat pre-emphasized, see Fig. 4). "Bias" current from the 100 KC oscillator is supplied in series with the secondary of the transformers. The VU meter on the amplifier may be used to check the bias current and the program level.

The "Reproduce" head is similar to the "record" head since each has a balanced winding and a mu-metal shield to avoid possibilities of crosstalk or stray fields. Each head has a single screw adjustment to assure alignment of the core gap exactly at right angles to the tape motion. These adjustments are under the outer cover or shield to avoid inadvertent operation during regular recording conditions. Tape is arranged to give full contact with the heads even under very light tape tension. Operation of the reel-control knob raises the tape from the heads during fast winding operations—and intermediate positions permit a gradual lowering of the tape. Thus, it moves lightly over the "reproduce" head and cueing operations are facilitated.

With a 15,000 cycle tone on a tape moving at 15 inches per second, one full wavelength of the recorded signal will be only .001 inch long. If the gap in the magnetic head, across which the signal is produced, is .001 inch wide then it would span just one wavelength of the recorded signal and no signal would be reproduced. This is the so-called "cancellation frequency," well known in sound-film, and magnetic-wire and tape recording. It is obviously necessary to use a gap shorter than this, preferably one which is less than half a wavelength (.0005 inch). This gap must be perfectly straight and smooth, and for this reason tolerances in the micro-inch region are employed in the design of the "record" and "reproduce" heads. Lapping techniques, similar to those used in optical work have been developed by RCA for application in the RT-3A magnetic heads. In addition, these parts are assembled with the same care and precision as that employed in producing microphones such as the KB-2C and the famous 44-BX.

The Recording Tape

The RT-3A tape recorder is designed to accept and use any of the standard quarter-inch magnetic tapes now on the market. The frequency-response compensation curves are adjusted for a high quality tape which is available from RCA.

FIG. 9 (below). The studio model RT-4A recorder as it will be supplied in a desk type console. Recorder and amplifier are "built-in" with extra desk-top space provided. Below the desk top, space is available for mounting additional amplifiers.



Several points concerning good recording practice with tape are included here. Over-modulation in recording on tape should be avoided since it results in at least three undesirable effects: (1) It increases distortion, (2) It causes poor erasure so that the next program will have more noise in the background, (3) It causes the signal to "soak" through from one layer to another in storage so that a "crosstalk" effect may appear in the program with time. It has also been found that storage in warm or hot places increases the tendency of the program to "soak" through.

Where storage of program masters or recordings for indefinite long periods are involved, it may be more economical and desirable to employ standard disc recorders for this purpose. However, for simplicity and ease of recording, hi-fidelity, long playing, or ease of editing, magnetic tape holds many advantages. It is also economically desirable where the program is recorded, reproduced and the tape is then ready for another program.

Console Studio Model (RT-4A)

The RCA Tape Recorder will also be available to the broadcaster in a modified version (see RT-4A, Fig. 9) for studio use which retains all design features of the portable model. It will be suitable for installing in the control room, adjacent to the studio consolette or turntables.

The motor board will be similar in most details to the portable version. It will employ connector sockets on the rear identical to those used in the RCA plug-in amplifier line. The studio unit is planned so that it may be mounted in a standard 19 inch audio equipment rack, or in a special desk console provided for it.

The amplifier will also be similar to the portable version, but rearranged for plug-in or standard RCA type BR-2A shelves. It will also easily mount without any change in the special desk console, with all controls conveniently arranged just below the recorder in a nearly horizontal plane with a work shelf in front of the controls.

There will be adequate room and standard mounting brackets available in the base of the console for at least one shelf of amplifiers. It is anticipated that a limiter amplifier may be desirable for some record-

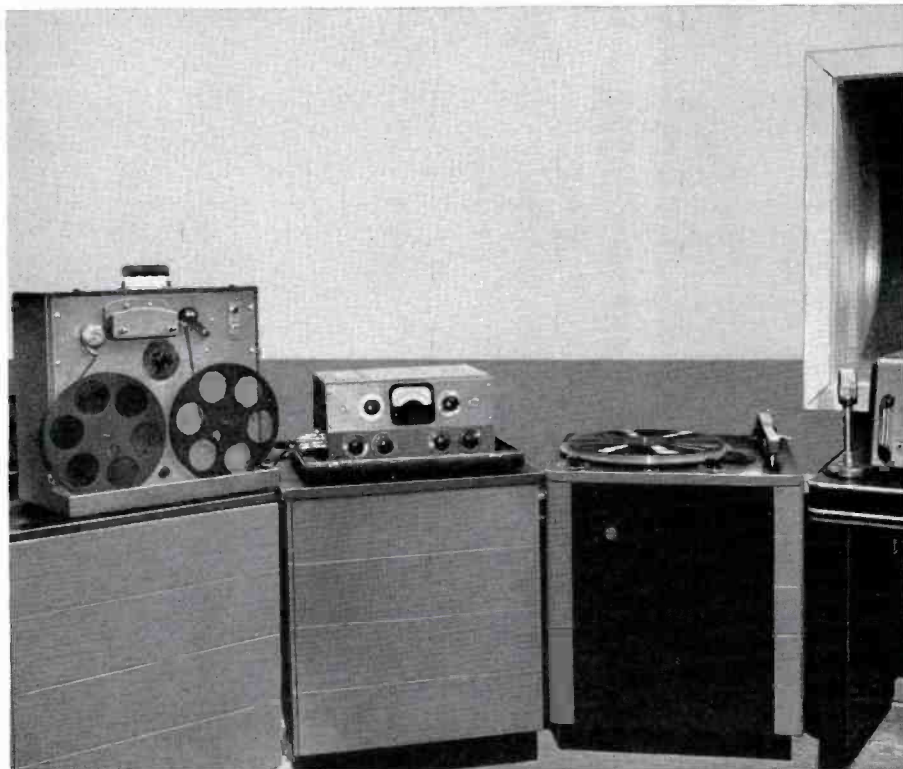

FIG. 10 (above). Typical recording setup in the control room with RT-3A recorder shown at left, amplifier center, and turntable and consolette at extreme right.

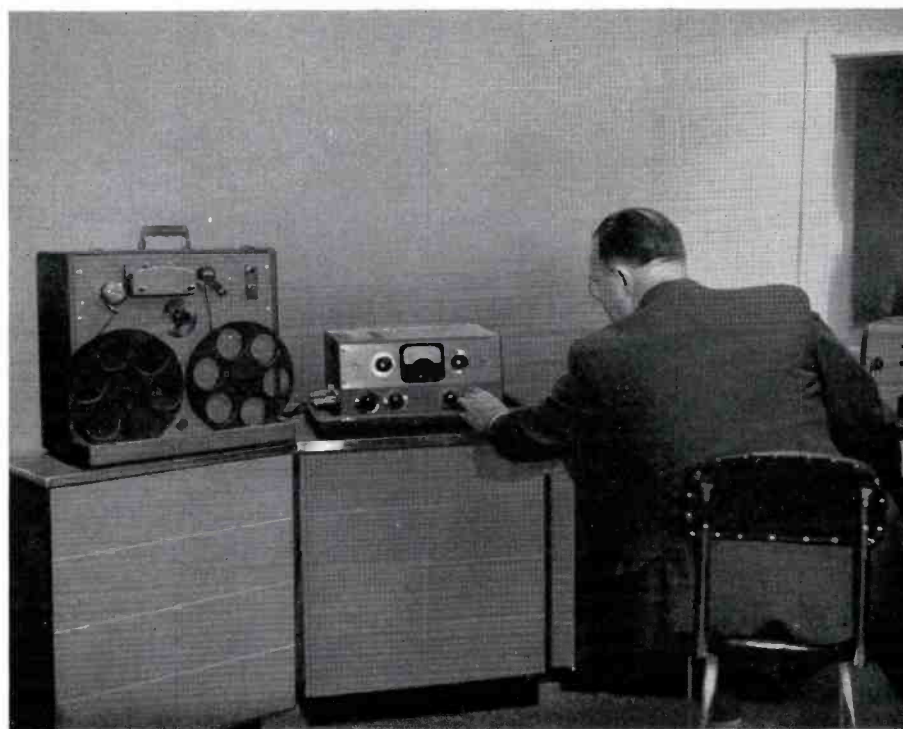

FIG. 11 (above). In this view, the operator at the consolette is "playing back" and putting the recorded program on the air. Note that amplifier controls, turntable and consolette may all be easily reached from the operator's position.



FIG. 12 (above). Here, a program originating in the studio is recorded in the control room with the RT-3A recorder. Note that cable lengths and connections permit use of various arrangements of the recorder and amplifier.

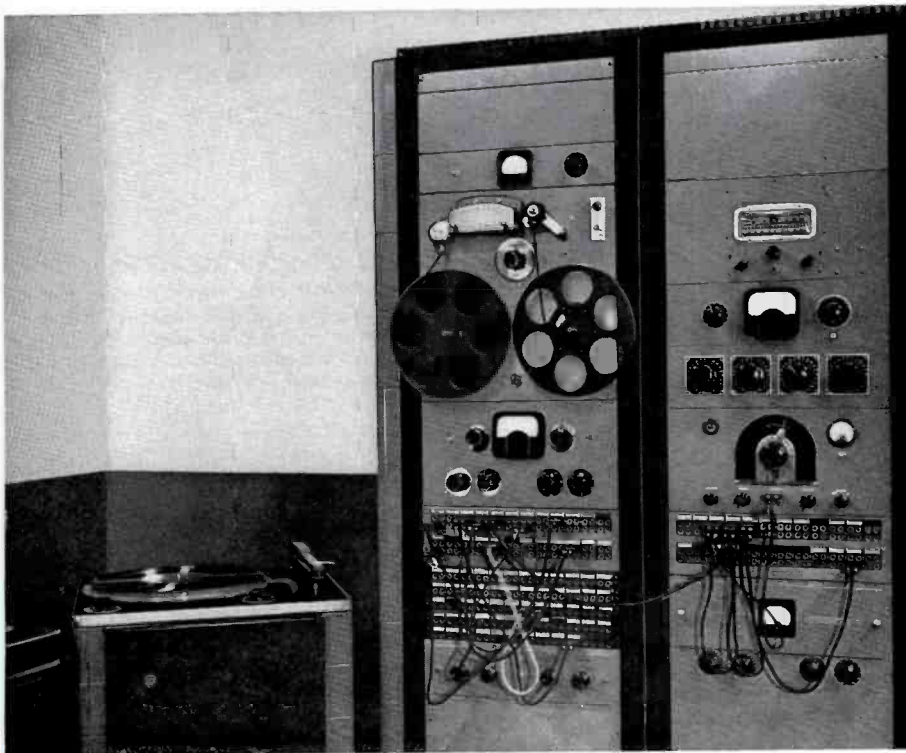

FIG. 13 (above). Closeup of typical control room setup where RT-5A is rack-mounted in a standard BR-84 series audio equipment rack. Recording is easily handled by operator at the console (a remote control switch at console starts and stops recordings).

ing applications, or a BA-4C for monitoring in other cases. This arrangement may be easily handled by a single operator from his position at the studio control desk. Remote starting and stopping may be easily incorporated.

Similar equipment in a rack equipment mounting (see RT-5A, Fig. 13) may be desirable for small or crowded studio control rooms. The tape can be loaded and cued at the rack, then started from the control desk with a remote control switch.

Tape Recorder Systems

The RT-3A recorder, as illustrated in the various photos included, is employed efficiently in the broadcaster's studio, studio control room or at remote locations, as desired. The RT-3A lends itself well (in addition to remote or regular program assignments) to system layouts where more elaborate recording jobs must be done. Fig. 14 shows a simple system that will give continuous "record" or "reproduce". In this setup two RT-3A recorders are used and either machine may be recording while the other is playing back. Only the simple addition of the switches shown would be required, since the RT-3A equipment includes necessary amplifiers, meters and headphone cueing facilities.

The diagram of Fig. 15 illustrates a slightly more elaborate setup in which two sets of switches are used. In this arrangement, the proper impedance matching should be obtained. If the input lines are terminated externally, nothing more is required, since line input positions are bridging on the RT-3A design. Either or both recorders may operate from input lines singly or simultaneously. When recording long programs, this permits the recording of some overlap. It also makes possible the duplicate recording of an important program, when desirable.

The output circuit is similarly connected and a matching pad should be used if the two recorders are to be played back simultaneously over the same line (for example, where two sound effects are mixed). A cue circuit is shown which could be used as a second outgoing line, or connected to an amplifier and loudspeaker for cueing.

An additional feature which may be incorporated in the above systems is the use

of a suitable limiting amplifier such as the RCA 86-B. This will permit a higher average level to be safely recorded on the tape, and at the same time avoid effects of overmodulation.

In addition to the above recording arrangements, there are many other possible combinations which might expand into the use of additional RT-3A recorders for the simultaneous recording of several programs. RCA engineers are ready and equipped to assist in the design and layout of special tape recording systems to meet particular requirements.

Performance

The RT-3A professional tape recorder will provide the broadcaster with an essentially flat frequency response from 50 to 15,000 cycles, when recording at a speed of 15 inches per second. (See performance curve of Fig. 16.) In addition to its excellent frequency response, the RT-3A is designed to assure a low level of noise, wow and flutter. A list of the general electrical and mechanical performance characteristics of the RT-3A recorder is given below.

Summary of Performance Characteristics

The RCA Broadcast Portable Tape Recorder, Type RT-3A, will have the following general technical characteristics *when used with the proper tape*:

INPUT: Microphone level, 150/250 ohms or bridging from 600 ohm line. Gain control on recording amplifier. VU meter to check recording level.

OUTPUT: Maximum +18 dbm at 150/600 ohms. Gain control on playback amplifier. VU meter can be used to check output level.

MONITORING: The output (playback) amplifier is entirely separate from the recording amplifier so the program on the tape may be checked by headphone while recording.

TAPE SPEED: 15 inches per second, or 7½ inches per second. Speed may be selected by a switch on the amplifier which also changes the amplifier's compensation curves.

TAPE WIDTH: ¼ inch.

PLAYING TIME: 33 minutes at 15 inches per second.

66 minutes at 7.5 inches per second.

REWIND TIME: Approximately 3 minutes in either direction.

FREQUENCY RESPONSE: 50 to 15,000 cycles at 15 inches per second in accordance with NAB.

50 to 7,000 cycles at 7.5 inches per second in accordance with NAB.

SIGNAL-TO-NOISE: Better than a 50 db ratio on the tape (below peak recording level).

45 db or better for the playback amplifier (below peak recording level).

WOW AND FLUTTER: 0.2% RMS at 15 inches per second.

0.3% RMS at 7.5 inches per second.

METERING: All tubes, erase and bias voltages, recording and output levels may be checked with the standard VU meter.

MAGNETIC HEADS: Single, plug-in assembly with erase, record, and playback heads.

MECHANICAL: The amplifier case has room for the reels and connecting cord. It is 15 inches high, 21 inches long, 10¾ inches deep and weighs 49 pounds.

Recorder case is 19⅞ inches long, 18⅜ inches high, and 11⅞ inches deep. Weight, 44 pounds.

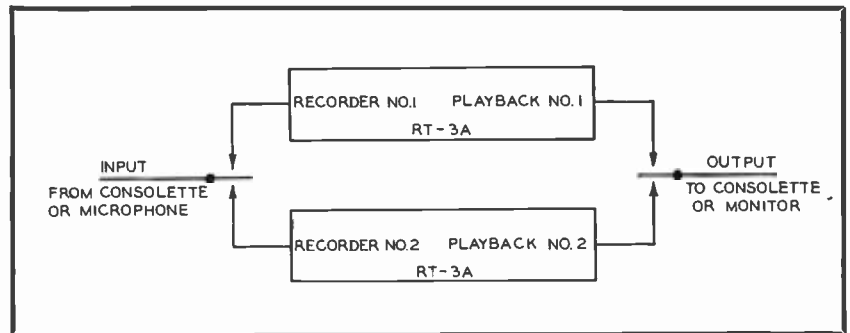

FIG. 14 (above). Systems setup for two RT-3A recorders which provide continuous "record" or "reproduce" (either machine may record while other plays back).

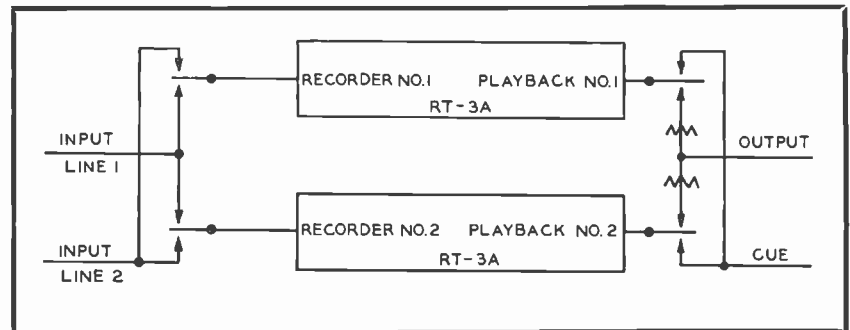

FIG. 15 (above). Setup of two RT-3A recorders with extra switches provided to permit operation from input lines singly or simultaneously, as desired.

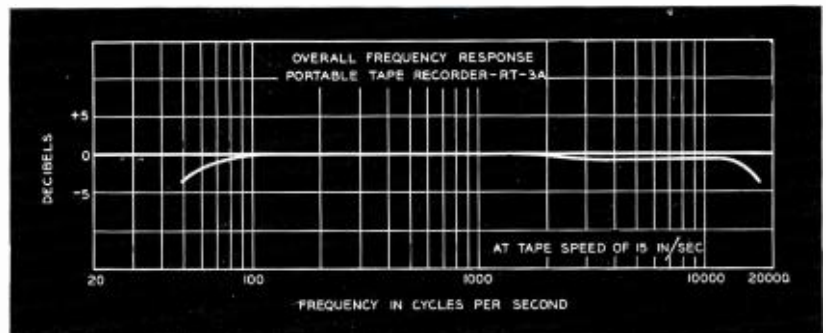

FIG. 16 (above). Frequency response of the RT-3A recorder is essentially flat from 50 to 15,000 cycles, as shown above.



WENR-TV

by
E. C. HORSTMAN
Engineering Director, ABC Central Division
and
J. M. VALENTINE
Supervisor of TV Operations, WENR-TV

WENR-TV, the American Broadcasting Company's Chicago key station, staged its own personal "T-Day" on September 17, 1948. Since then, WENR-TV has continually expanded its program service until today it is feeding more program hours to the network than any other station.

WENR-TV's present (February '49) schedule includes over 30 hours of program time. Over 60% of this is originated in

Chicago. Even more significant—some 15 hours of it consists of studio shows.

General planning of the WENR-TV installation was under the direction of Frank Marx, Vice-President of ABC in charge of engineering. E. C. Horstman, Engineering Director of ABC's Central Division planned the details of the installation and supervised the construction of the station. He was assisted in this part of the operation by William Cummings, Supervisor of AM operations, Robert B. Whitnah, Station Engineer, and Hugh Abfalter, Assistant Station Engineer.

All of the WENR-TV facilities are located in the modern Opera Building at 20 North Wacker Drive. The 44th floor houses the RCA 5 KW TT-5A Transmitter, a 10 KW FM BTF-10B Transmitter, the film projection room, a live talent

studio, the control room, a maintenance room and dressing rooms. TV engineering and programming offices are on the 5th floor; traffic sales and publicity offices are on the 16th floor. The main floor houses the ABC Civic Studio, formerly the Civic Opera Theater, first acquired by WENR for use in production of AM shows.

The Opera Building is an ideal location for WENR-TV facilities. Not only does it provide a studio for audience participation shows (the Civic Opera Theater), but it is centrally located in the Chicago urban area, it is the highest building in the city, and its steel-concrete walls and floors provide adequate support for the equipment, as well as for the RCA combination TV and FM antenna mounted on the roof. A marquee, supported by huge columns extends the full length of the

FIG. 1 (opposite). A scene from WENR-TV's top-rated show, the Super-Circus, a weekly hour-long program fed to the entire ABC network. With a Telepulse rating of 39.0 (week of Jan. 3) this is the top-ranking studio show produced in Chicago.



FIG. 2 (right). Another scene from the Super-Circus program. Although WENR-TV is the newest Chicago TV station, the Chicago Telepulse ratings for January show it with four of the ten top-ranking shows.



FIG. 3. The modern Opera Building at 20 North Wacker Drive where all of WENR-TV's facilities—studios, film rooms, transmitter room and antenna—are located. The 4-section Pylon with 6-section Superturnstile on top (right corner) of building is the combined antenna of WENR-FM and WENR-TV.

building, beautifying the adjacent entrances to the office building, the ABC Civic Studio, and the historic Opera House. Located less than three city squares away is the Illinois Bell Company through which all WENR-TV coaxial network lines are routed.

Work to adapt this building to TV operation was begun in January, 1948. By August, WENR-TV was on the air with a test pattern. Construction work consisted of pouring new concrete floors with trenches to accommodate wiring; sound-proofing and insulating of walls and ceilings; installing a ventilating system for the rooms, and exhaust ducts for the equipment; and provision of a support on the top floor for the base of the antenna. Power lines and video cables were run to the 44th floor through air shafts in the building.

Equipment for air-conditioning the rooms, and exhaust ventilation of the power racks, is located on the 45th floor. Ducts for air conditioning (transmitter room, studio, film projection room and studio control room) are installed in the ceilings. After installation of the ducts, insulation was added and the ceiling covered with perforated celotex. Exhaust ducts for the racks are run below the ceilings.

One of the principal features of our layout is the fact that we have a studio, control room, projection room, transmitter room, and a workshop located together on the same floor. This permits very close coordination between the operators at the different locations. The proximity of these rooms makes it practical to run private telephone lines wherever desirable, and it allows time-saving cross-checks if anything goes wrong at any point in the system. Moreover, the cost of running power and video cables is reduced, and air conditioning problems are simplified.



FIG. 4. Technical activities of WENR are under the direction of E. C. Horstman, ABC's Central Division Engineer, J. M. Valentine, Supervisor of TV Operations, and William Cummings, Supervisor of AM Operations. In this group picture are, left to right, Mr. Cummings, Marvin Gaskill (associate editor of Broadcast News), Mr. Horstman (with hand on camera), and Mr. Valentine.

FIG. 5 (right). Estimated 5000 and 500 microwolt contours of WENR-TV. Station's antenna, 668 feet above street level, is the highest structure in Chicago. A six-bay RCA Superturnstile, with a gain of 7, this antenna, together with the RCA TT-5A transmitter, provides the station with 25 KW effective radiated power. This, with the height, accounts for the surprisingly good coverage of the station.



FIG. 6 (below). This is the control room corner of the penthouse studio during construction. Drop-ceiling type construction was employed in this two-story high studio.



FIG. 7 (below). This is the film projection room during one stage of construction. Pouring of a false floor made it possible to provide wiring trenches and ducts between all main units. These trenches, shown open in this view, are provided with heavy steel coverings which protect wiring but are easily removable when changes or additions in wiring are required.

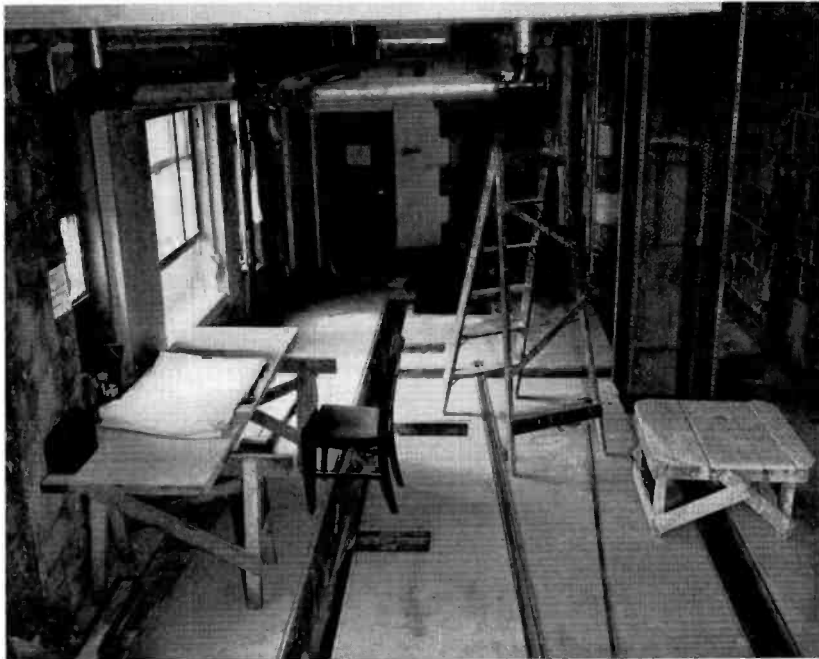

WENR-TV's PENTHOUSE STUDIOS

The Penthouse Studio on the 44th floor of the Civic Opera skyscraper is the smaller of our two studios. Because the control room is built into one corner, the resultant studio space is L-shaped. However, the corner adjacent to the control room is used for storage of props and so the actual studio space available is rectangular in shape, measuring 35 feet by 25 feet by 18 feet high.

In spite of its relatively small size, the Penthouse Studio serves for the production of a large part of WENR-TV's originations. Advertising commercials, children's programs utilizing cartoonists and puppets, small dramatic productions, and soloists are typical of the programs produced daily in this studio.

We believe the key to successful operation in a small studio is to equip it

adequately with cameras, lights and microphones, and to arrange the sets methodically so that very little movement of the equipment is required to put on successive programs. The Penthouse Studio is equipped with three studio cameras with pedestal mountings and as many as six or seven microphones, some types of which are directional or suited to special mountings and applications. For example, extensive use is made of the 88-A and 77-D types. One 77-D is mounted on an RCA perambulator type boom which permits placement of the microphone over the set, but out of the camera view. Another is mounted on a smaller boom type stand. Other microphones used are of the 44-BX type mounted on floor stands.

The amount of light we use in the studio depends, of course, on the size of the show, and the color and type of the costumes. Our practice is to provide a basic light

level of between 250 and 300 foot-candles, which provides a good signal-to-noise ratio for the image orthicon tubes in the cameras. We then use back lighting and spotlighting as required for proper contrast and artistic picture interest. A good part of our basic lighting is obtained from eight banks of six 40-watt fluorescent lamps, ceiling mounted. Fluorescent lighting is not only economical, both from the standpoint of power consumption and longer lamp life, but it is also a well-diffused and uniform light, producing excellent color response with present camera tubes. Other ceiling mounted lights consist of nine 2-kw. floods, and several spots ranging from 500 to 2000 watts. An almost identical complement of incandescent flood and spot lamps are mounted on portable stands for studio floor use. All ceiling lights are swivel-mounted and are moved and directed manually.

FIG. 8. Simplified drawing of the 44th Floor of the Opera Building where all of the WENR-TV facilities (except the auditorium studio) are located. The fact that studio, control room, projection room, transmitter room and shop are all on the same floor makes for a compact operating setup which is unusually convenient. Moreover, this arrangement was an important factor in minimizing the cost of running audio, video and power cables and in simplifying the air conditioning problems.

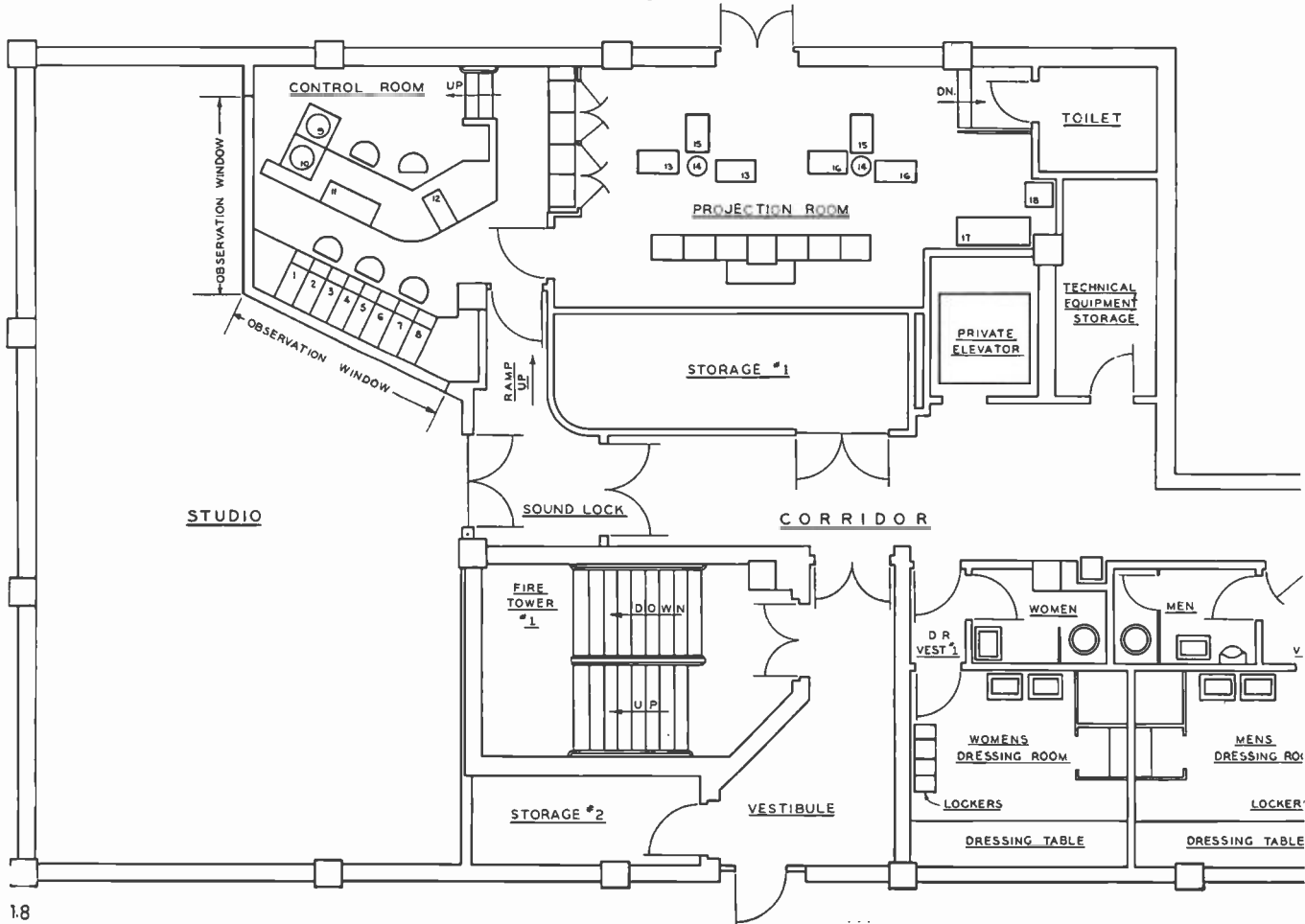

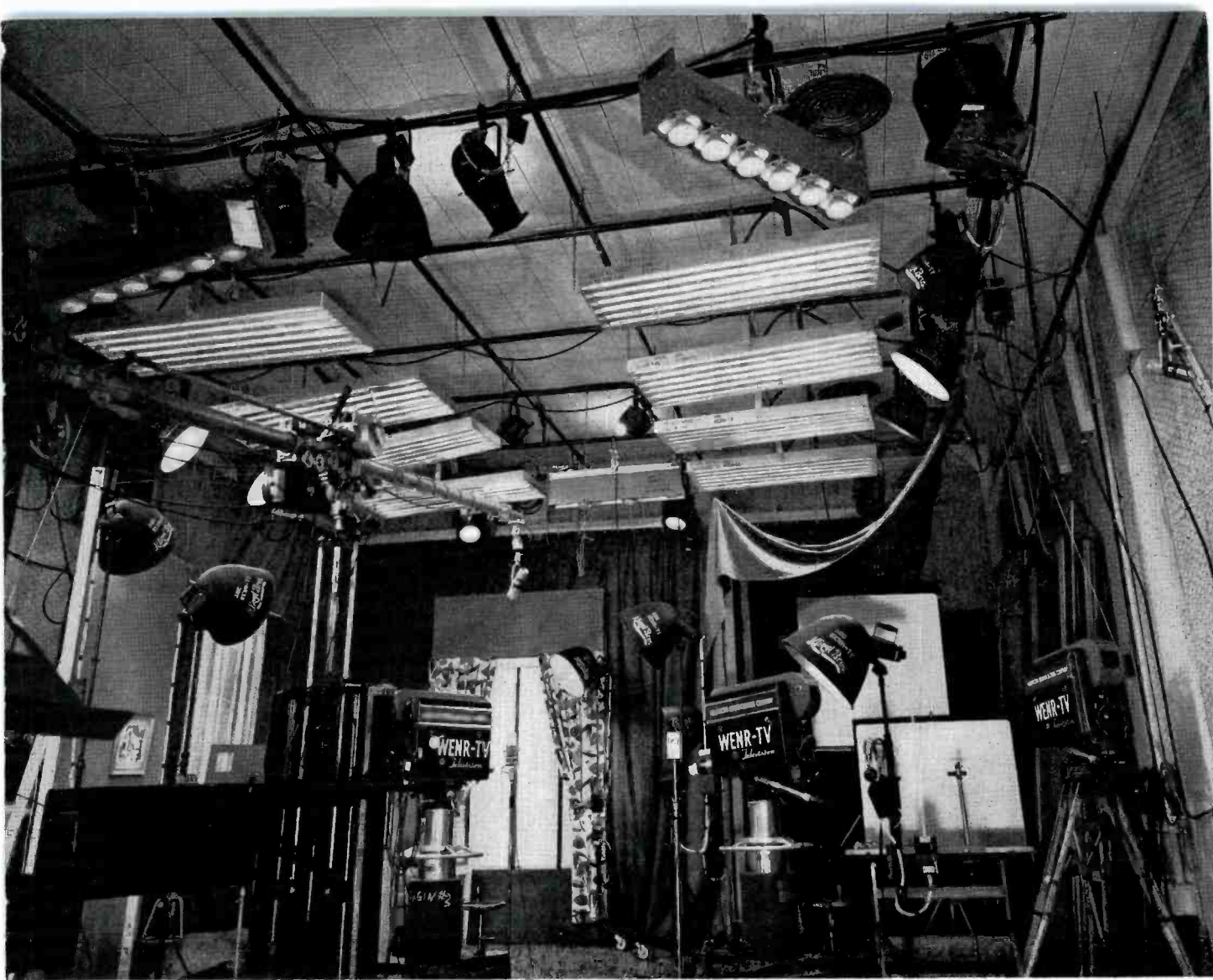
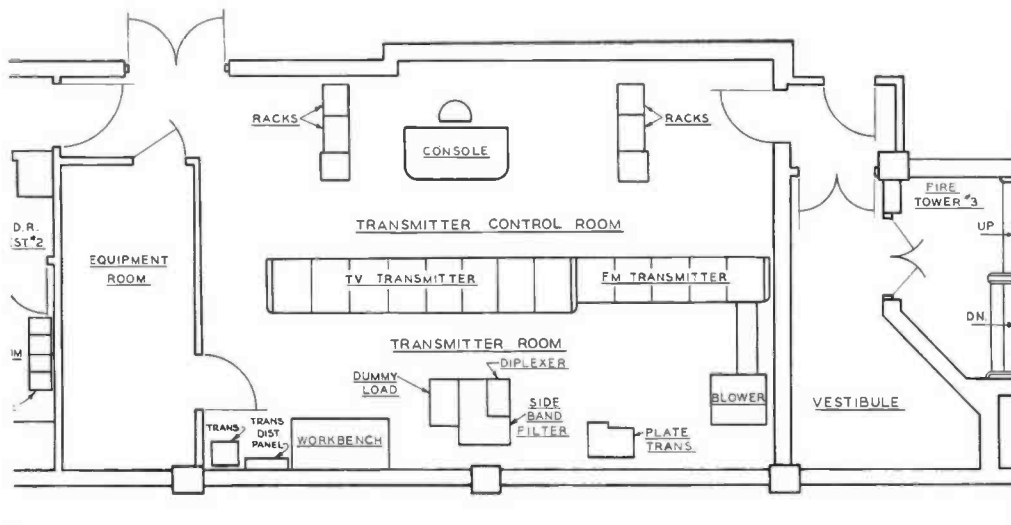

FIG. 9 (above). This is a floor level view of one end of the penthouse studio (see other views on next two pages). The operating part of this studio is 35 ft. by 25 ft. by 18 ft. in height. There is additional space in the corner next to the control room (see floor plan) which is used primarily for storage of scenery and props. Equipment in this studio includes three RCA Type TK-20A Studio Cameras; 88A, 77D and 44BX Microphones, banks of fluorescent lights, spots and other minor accessories.



CONTROL ROOM & PROJECTION ROOM EQUIPMENT

- 1- FILM CAMERA CONTROL #1
- 2- FILM CAMERA CONTROL #2
- 3- STUDIO CAMERA CONTROL #1
- 4- STUDIO CAMERA CONTROL #2
- 5- STUDIO CAMERA CONTROL #3
- 6- LINE MONITOR
- 7- CUE & REVIEW MONITOR MASTER SWITCH
- 8- REMOTE CONTROL
- 9- TURNTABLE
- 10- TURNTABLE
- 11- CONSOLE
- 12- MONITOR
- 13- 16 MM PROJECTOR
- 14- MULTI- PLEXER
- 15- CAMERA
- 16- 35 MM PROJECTOR
- 17- SPLICING TABLE
- 18- FILM STORAGE CABINET

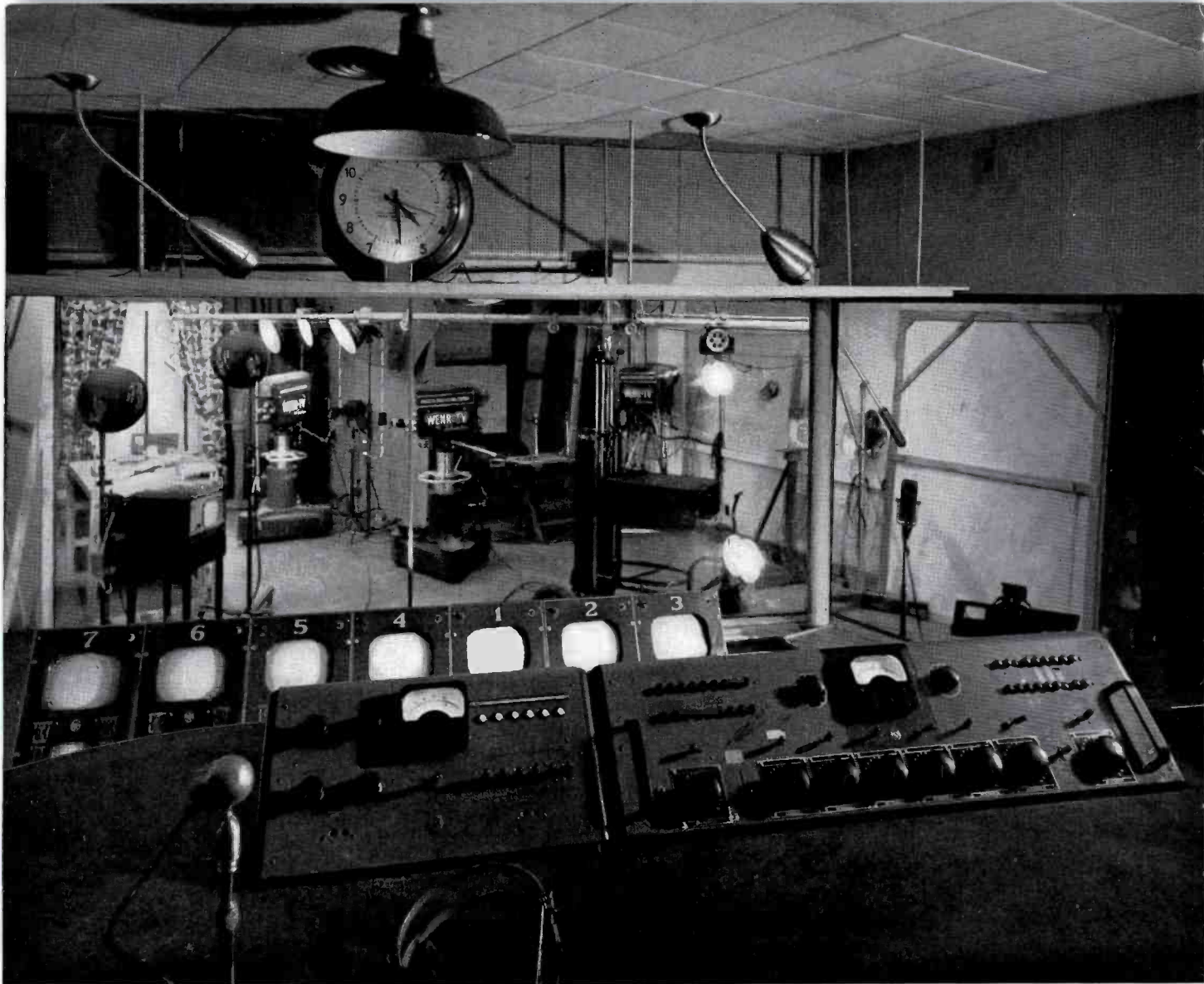

FIG. 10. This is a view (from approximately the director's position in the control room) looking into the penthouse studio. Seven video units—consisting of three studio camera control units, two film camera control units, an on-air monitor-switching unit and a preview monitor—are on the lower level just in front of the window. The audio equipment in the foreground includes a 76-D Consolette and a BCS-3A Auxiliary Console.

WENR-TV's STUDIO CONTROL ROOM

The control room for the Penthouse Studio is built into one end of the studio. It is elevated 17 inches above the studio floor, which allows plenty of space for video and power line ducts to run under the control room floor. This arrangement simplifies construction, and is desirable because it provides a part of the elevation required for program directing personnel to have good view into the studio. The program director's and audio director's control positions are on a platform in the control room elevated another 22 inches above the control room floor. This gives directing personnel a total elevation of 39 inches above the studio floor, enabling them to see the studio action over top whatever cameras, lights or microphones

might otherwise obstruct their view of the show.

The Penthouse Studio Control Room is in reality a combined studio, film and master control room. It contains control equipment for the three cameras in the studio as well as for two film cameras in the projection room. Video from the control sections of these cameras, plus a pickup line, regularly fed by the remote mobile equipment, are brought directly to a TS-1A master switching panel rack-mounted in the control room. This switching position allows selection of a variety of program material including studio shows, films or slides, boxing, wrestling, etc., to be fed to either the transmitter or to the network. Another similar control position rack-mounted in the transmitter room permits selection of either Penthouse Studio,

ABC Civic Studio or film room output for feeding the transmitter.

Equipment on the elevated platform of the Penthouse Control Room consists of an RCA 76 Consolette, which controls the audio from the studio and film projection room; two type 70-D transcription turntables; and a BCS-3A auxiliary control and PL switching unit through which the turntable output is fed. The program director, technical director and an audio operator sit at this control console. Below the platform in front of the control room window is a 7-section video console. This console contains a preview monitor for viewing remote pickups, a TS-10A video switching and lap-dissolving system with its associated program line monitor, and camera controls for the three studio cameras and two film cameras. A network line monitor

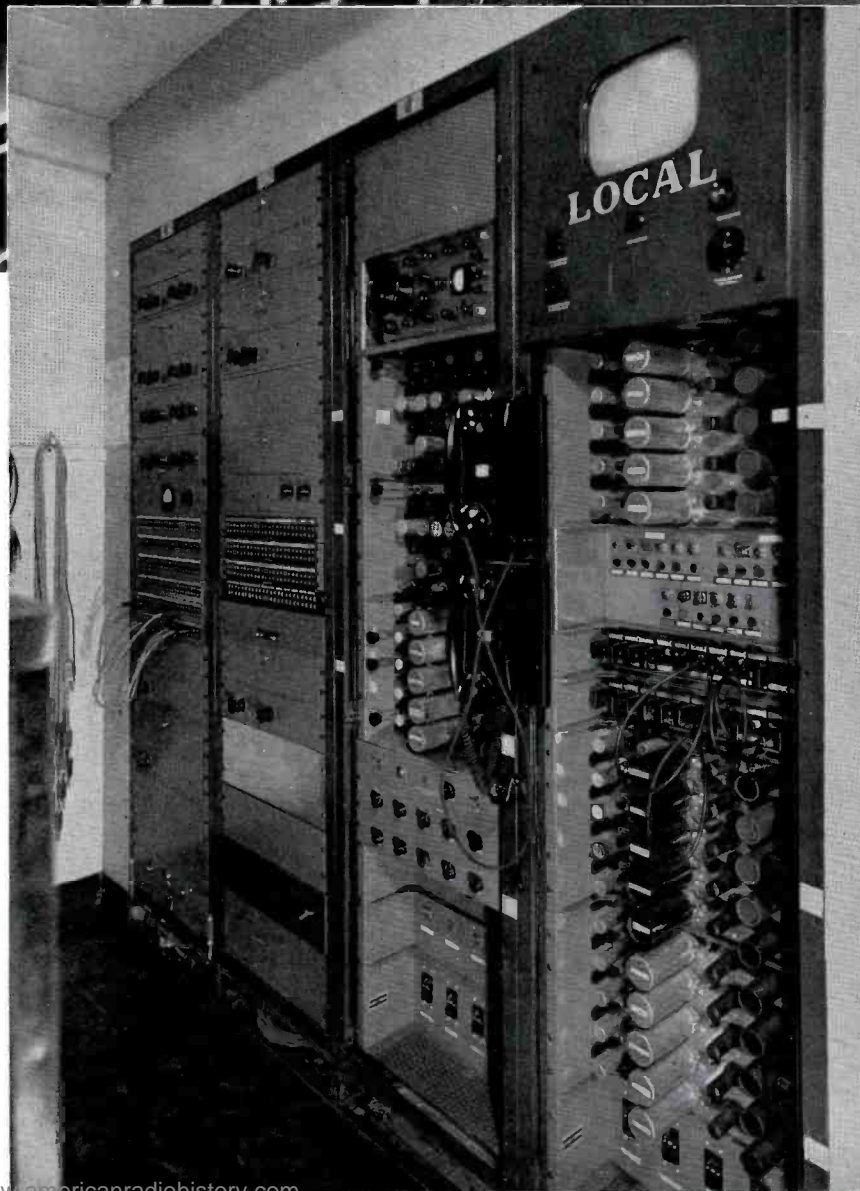

FIG. 11 (above). This view shows the arrangement on the upper platform to better advantage. Program director sits at the left, technical director in the center and audio operator at the right.

FIG. 12 (right). Power supplies, distribution amplifiers, audio switching facilities and monitors are mounted on standard racks mounted in the wall of the control room.

is mounted on a shelf above the control room window, where it is plainly visible to program directing personnel. Four operators are seated at the video console. Two of these video operators keep the studio camera output levels correct at all times. Another operator maintains correct levels from the two film cameras, and the fourth operator does the switching at the request of the technical director on the platform.

One-way communication from directing personnel to camera operators, boom operators, and video operators is provided by intercom circuits in the TV camera equipment. In addition, an amplifier system is used which provides two-way communication between studio control, the film room and transmitter room.



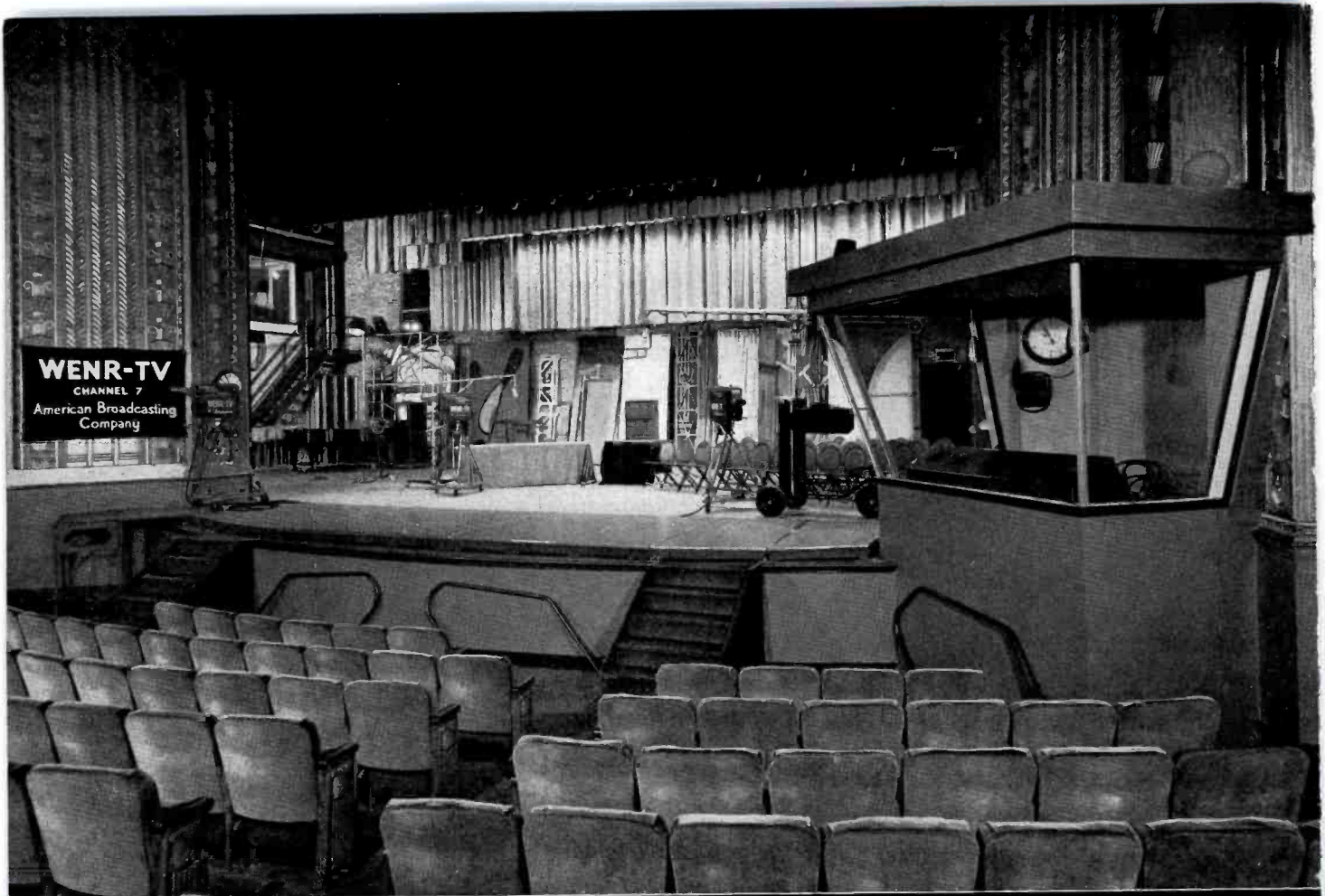

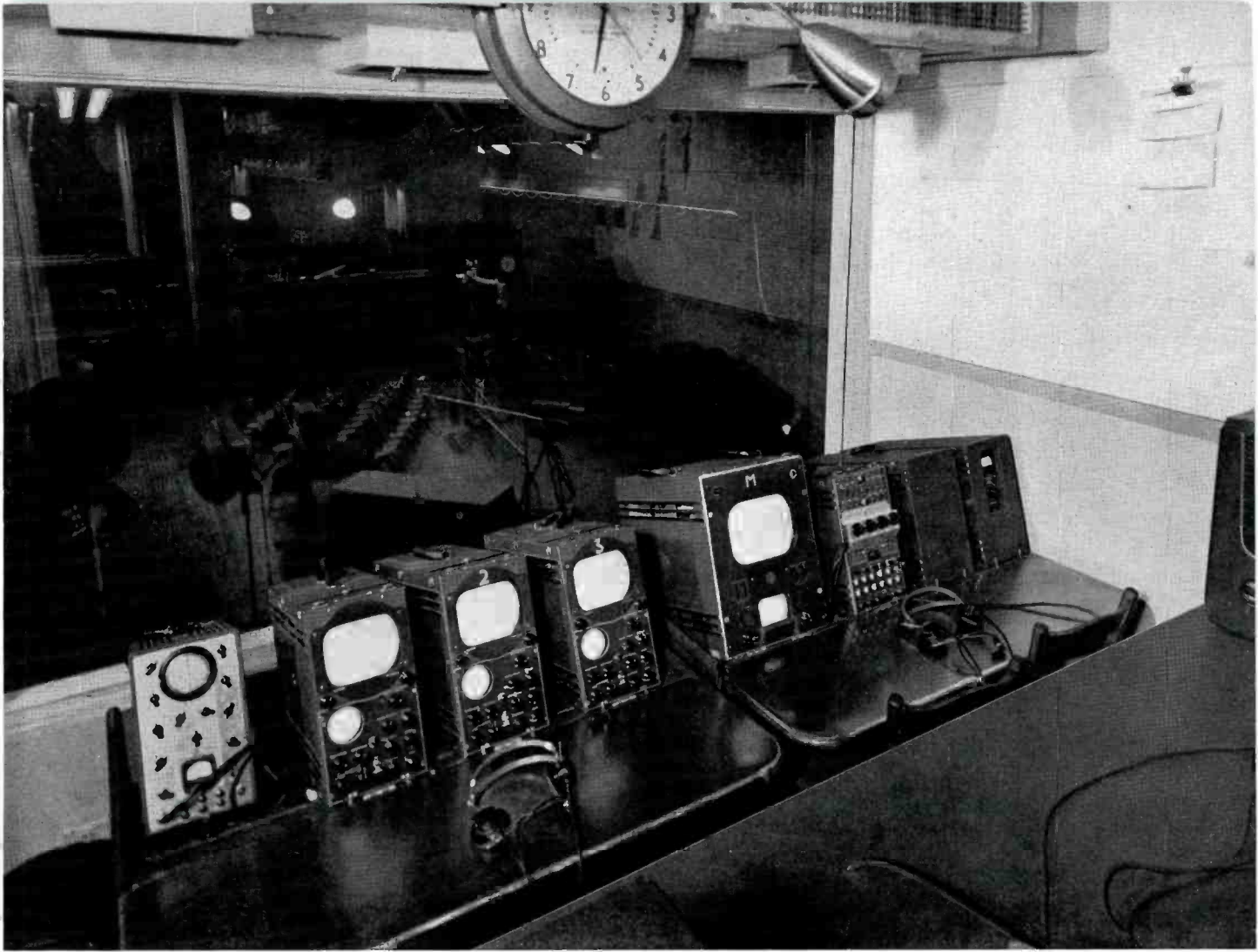

FIG. 13 (opposite page, top). View of the stage and proscenium of the Civic Studio. The glass booth at the right of this picture is the program director's booth. Five monitors provide him with pictures from all cameras, line and preview.

FIG. 14 (opposite page, bottom). The 70 foot wide, by 50 foot deep, stage of the auditorium provides ample space for even larger productions like the Super-Circus (cast of fifteen, plus band) with room on the front-stage apron for cameras.

FIG. 15 (above). This is a view in the engineer's control room looking out onto the stage. This control room is at the left of the stage (up the stairs visible at the left of Fig. 13). Standard RCA field equipment units are used in this control room.

WENR-TV CIVIC STUDIO AND CONTROL ROOM

The Civic Studio, located on the main floor of the Civic Opera Building, is used for the most elaborate type of television production. These include comedy, drama and audience participation programs. This studio originates such top-ranking TV shows as "Super Circus", Vaudeo "Varieties", "Stand By For Crime", and "Stump the Authors", familiar to ABC network viewers. The studio is also used for WENR (AM) originations such as the "Breakfast Club" with Don McNeil. The theater will seat 850 people.

After acquisition of the Civic Theater, the stage was enlarged to 50 feet by 70 feet. A glass enclosed program director's booth was built into the wall of the theater, near the front of the stage, and a con-

trol room to house the TV control equipment was built into the wall at one side of the stage, ten feet above the stage floor level. The program director's position, which contains video and audio monitors and communication facilities, is used for audience participation programs, where it is necessary for the director to be able to see the audience as well as the show. The entire audience is not visible from the control room at the side of the stage, but the program director is plainly visible from here to direct the control room operators in the switching of cameras, and otherwise conduct the program. The director's booth contains five monitors, one for each camera, a line monitor, and one for preview of upcoming programs.

The Civic Studio is equipped with three field cameras, a large perambulator type

mike boom, a smaller type KS-4A mike boom, and several portable lights. The field cameras are mounted on tripod dollies for utmost mobility.

The Civic Studio Control Room contains field camera controls for the three cameras, a field switching system for switching between cameras, master line monitor, field-type sync generator, and audio control equipment. As in the Penthouse Control Room, a modified RCA receiver temporarily serves as a network line monitor in the Civic Control Room. The field control equipment is mounted in front of the control window on RCA field desks which are designed with inclined tops to hold the equipment at a convenient position for viewing and operation. Behind the video control position, and elevated two feet above it, is the audio control position.

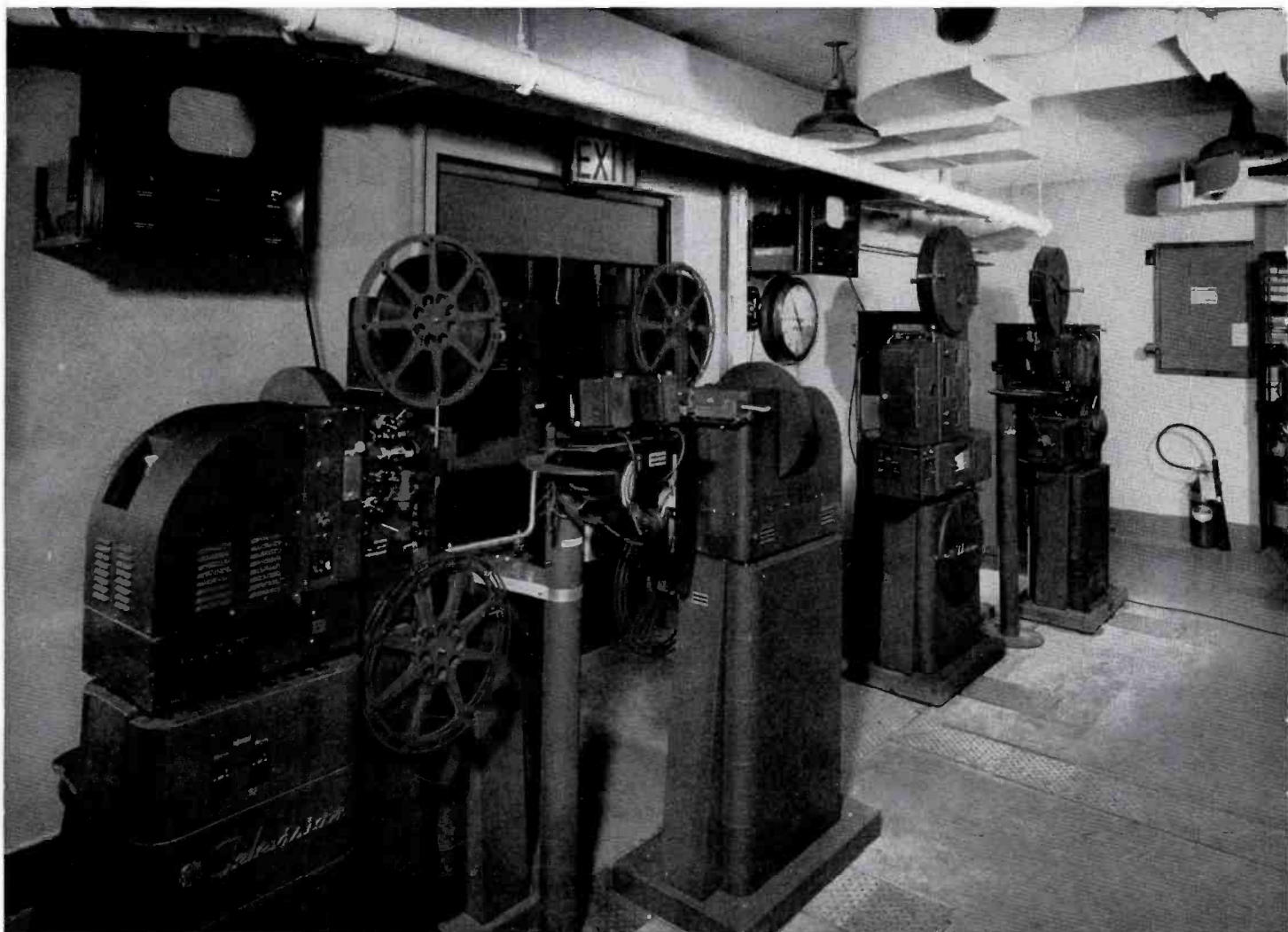

FIG. 16. This is WENR-TV's Film Projection Room. In the foreground are two RCA TP-16A (16mm) Projectors. Between them is a TP-9A Multiplexer and a TK-20A Film Camera. Further back are two RCA TP-35A (35mm) Projectors. Between them is a TP-9A Multiplexer and a TK-20A Film Camera. On the wall above each projector grouping is a monitor which allows the projectionist to see the picture transmitted.

WENR-TV's FILM PROJECTION ROOM

The film projection room, which is located adjacent to the studio control room, houses two 35mm projectors, two 16mm projectors, two film cameras, and racks which contain associated video amplifiers and power supplies. The two 35mm and two 16mm projectors are set up in pairs facing each other, so that the 35mm projectors serve one film camera and the 16mm projectors serve the other. Multiplexers between each pair of projectors reflect the images into the film cameras and also provide for the mounting of slide projectors.

The projection of multi-reel shows can be carried on without interruption by threading up both projectors in advance,

and merely switching over to the other projector as reels are used. The projector stop and start mechanism, which is instantaneous, can be controlled at the projectors or at the racks.

The projection room is large enough (30 ft. x 20 ft.) to provide storage space and plenty of walk-around room in front of and behind the racks. Spare tubes, test equipment and tools are kept in a double cabinet at one end of the room. A service bench is conveniently located along the wall near the cabinet. Two wall-mounted RCA receivers, plainly visible in the photo, are used for monitoring the two film camera outputs. In addition, a line monitor rack-mounted on one side of the room (not shown in photo) displays to operating personnel the picture going to the transmitter.

The two camera control units for the two film cameras are located in the studio control room. These control units are manned by a video operator who constantly watches over the quality of the pictures produced by the film cameras.

WENR-TV MOBILE FIELD EQUIPMENT

The mobile field equipment used for programming of sports and other events at the local Armory and at Rainbo Arena consists of two vehicles and an attachable trailer. The two vehicles carry a three-camera field chain, auxiliary lighting equipment, props and operating personnel. The two-wheeled trailer is a power generator which supplies 120-volt ac to operate the equipment.

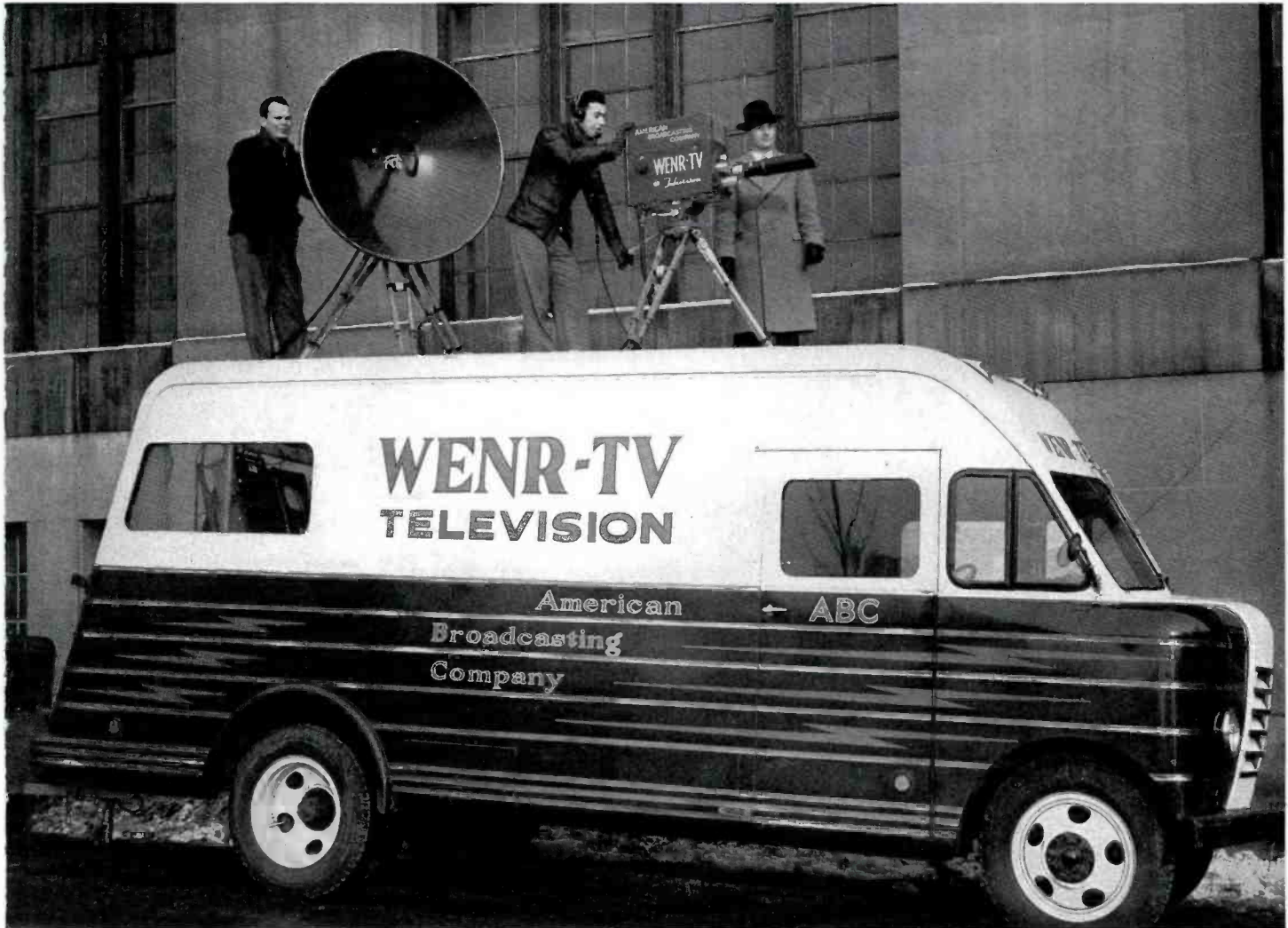

FIG. 17 (above). WENR-TV's mobile equipment includes a standard RCA TJ-50A Mobile Unit complete with portable camera equipment and RCA microwave relay gear.

FIG. 18 (right). With the TJ-50A Unit WENR-TV uses a panel truck (left in this view) for carrying auxiliary lighting equipment, props, and accessories, and a two-wheel power generator for use at locations where a-c is not easily obtained.



Pickups of boxing and bowling are made regularly every Tuesday and Wednesday at Rainbo Arena, about six miles from the studio building. The picture and sound is sent back to our studios by microwave relay and telephone line. Since we make regular pickups at this point (and also at the Armory), we have installed telephone line jackboards which enable us to transmit the sound as well as maintain wire communication with our studio and transmitter control operators. An eight-man crew under the direction of Mr. William H. Cassie carries out our field operations.

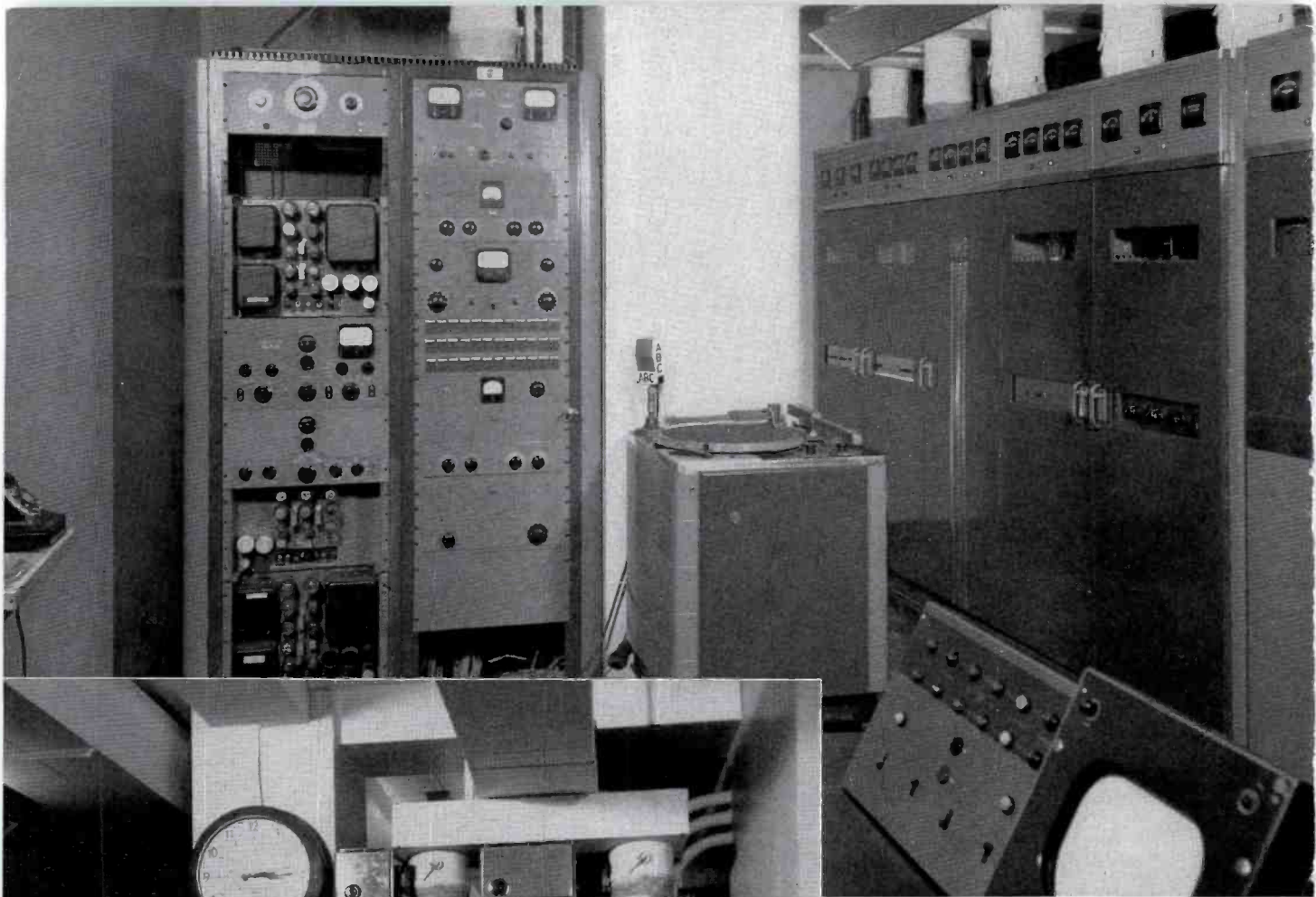

FIG. 19 (above). The view above shows the FM end of the transmitter control room (see floor plan, Fig. 8). The RCA BTF-10B FM Transmitter is at the right. At the left are racks containing audio and monitoring facilities, power supplies, etc. Turntable used for FM fill-ins and for testing is in the center. In the foreground is a corner of the TV transmitter control console.



FIG. 20 (left). This view shows the TV control and monitoring racks at the opposite end of the room. Rack on the left contains frequency monitoring equipment and audio amplifiers for TV sound. Rack on right contains, from top to bottom, a TA-5B Stabilizing Amplifier, a TA-1A Distribution Amplifier, Video jack panels, a TS-1A Switching Panel, another TA-5B Amplifier and several monitoring units.

WENR-TV TRANSMITTER ROOM

The transmitter room of WENR-TV was made large enough to house the TV and FM transmitters. The two transmitters are installed end to end in the center of the 25 ft. x 40 ft. room. The control position for the two transmitters is located between two partial partitions jutting from one side-wall. The input and monitoring equipment racks for each transmitter are built into these partitions, facing each other, with the standard TV transmitter console between them. The sideband filter for the TV transmitter is located behind the transmitter, and the water circulating system is in an adjoining room. Further construction

plans are to enclose the ventilating ducts above the transmitters and equipment racks to provide flush-mounting appearance. The width of the transmitter room provides plenty of walk around room behind the transmitter. A small workbench in front of the windows and a metal cabinet hold tools, test equipment items, spare tubes, etc.

The eight individual cabinets of the television transmitter contain all the necessary components for both the aural and visual parts of the signal. The left half of the transmitter contains the aural components; and the right half, the visual. The control console in front of the transmitter contains the stop-start switches, video and audio

gain controls, and a picture monitor. During transmitter operation, the picture monitor is used as an on-the-air signal monitor, the waveform oscilloscope serving to indicate levels of video modulation. Although, for test purposes, the monitor and oscilloscope can be switched to various circuits in the transmitter.

TV control facilities include a rack-mounted program switching panel which enables the transmitter operator to select the required source of program for feeding to the transmitter. This switching panel consists of interlocking push buttons which switch video lines directly.

FIG. 21 (below). This view shows WENR-TV's RCA TT-5A Television Transmitter. This transmitter is mounted in line with the FM transmitter shown on the opposite page (see Floor Plan, Fig. 8). The transmitter control console is in the right foreground. A feature, visible in this picture, is the simple, but very effective arrangement of ducts for exhausting the heated air from the transmitter units.

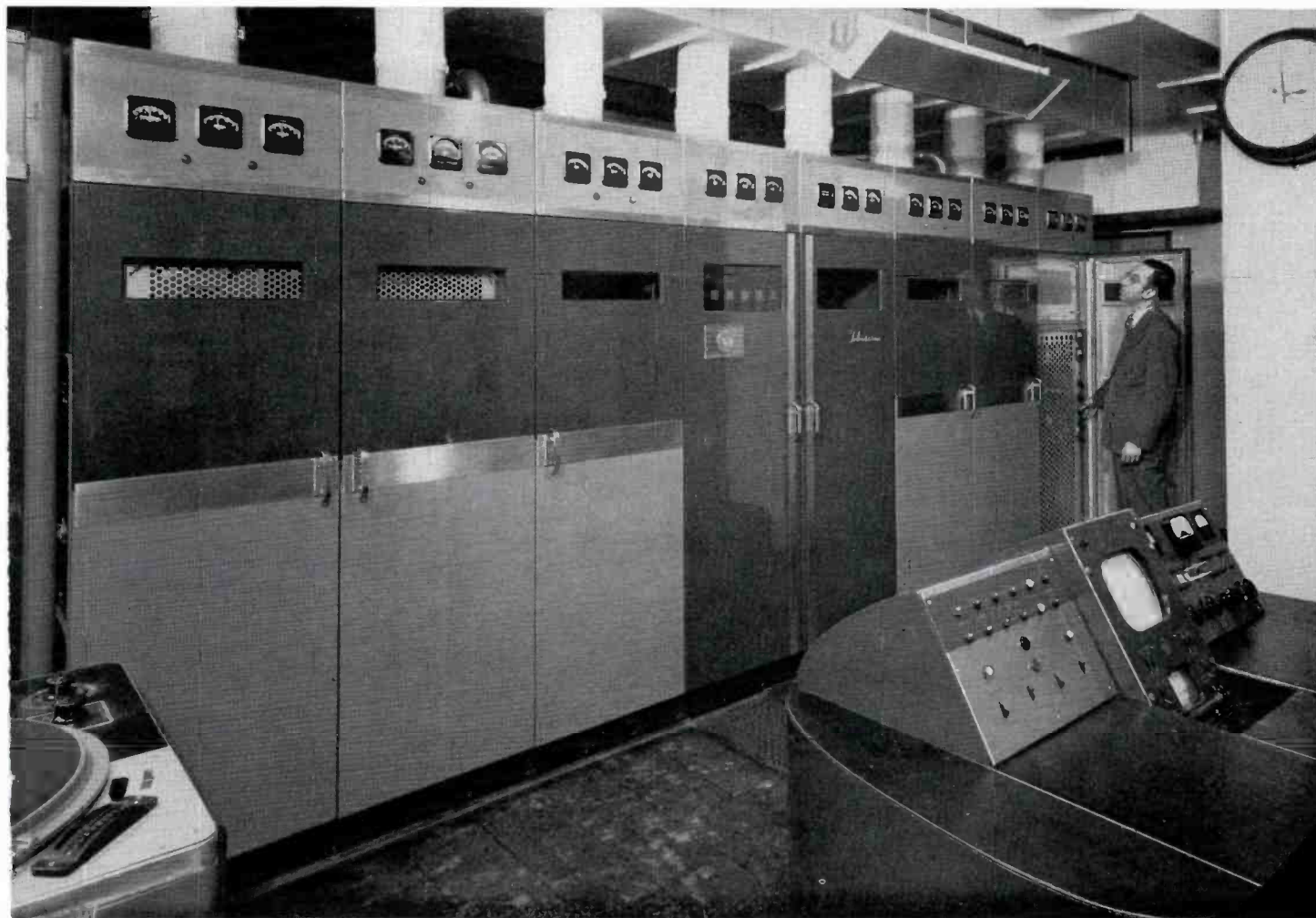

WENR-TV VIDEO SYSTEM

An important part of the engineering and planning of WENR-TV was the provision of control facilities which would enable us to produce almost any type of TV program and to do it efficiently.

To do this we had to anticipate our requirements for switching between the two studio control rooms, the film room and the transmitter. It was found possible to combine the functions of our penthouse studio control and master control in the one room and thus save space otherwise required for a separate master control room. This was done by installing a master control panel in a control room rack, and bringing the video from studio cameras, film cameras, incoming net and relay receivers directly to this panel. Three outputs from this panel feed separately to our network line, the transmitter and the viewing monitors. Thus, it is possible to feed any one of our program sources to either the transmitter or the network (or both) as desired.

To add still further flexibility to our control system, we installed a similar master switching panel in the transmitter room. This switching panel is fed normally by one output of the studio master switching panel. However, we found it desirable to provide a plug and jack system in the studio control room which enables us to by-pass the studio master switching panel, and thus use the control panel in the transmitter room as a master control position. This is a convenience when the Penthouse Studio is not in operation and the switching operation resolves itself to that between the output of the Civic Studio on the main floor, the network, and possibly relay pickups. The transmitter operator then performs the necessary switching.

As can be seen by the block diagram, the switching system for the Civic Studio also feeds into the master control panel. When programs are being produced in the Civic Studio, and control is centered in the transmitter room, the master switching panel is punched for feeding to the transmitter and left in this position.

Also shown in the diagram are a number of amplifiers designated as Distribution Amplifiers (DA) and Stabilizing Amplifiers (Stab. Amp.). (Each block marked "DA" represents one channel of a 5-channel TA-1A Distribution Amplifier unit. Thus, the number of blocks does not indicate the number of TA-1A units in use.) These Distribution amplifiers, which are rack-mounted units, serve as isolation amplifiers when additional monitors are connected to the line. They are also used to combine sync with the video signal, as is the case in the penthouse control room. While sync can be added to the video signal in the camera control sections, for studio operation it is common practice to add it *after* camera switching, and thus avoid any interruption of the sync signal which might otherwise be brought about by switching.

The TA-5B Stabilizing Amplifier, which is a video amplifier with special tubes for maintaining correct picture-sync ratio and suppressing noise, is used in network and relay input lines where the incoming signal might be defective in these respects. A TA-5B is also used at the input to the transmitter to assure that a signal correct in all respects is delivered to the transmitter. The TA-5B is automatic in operation after level controls have been preset.

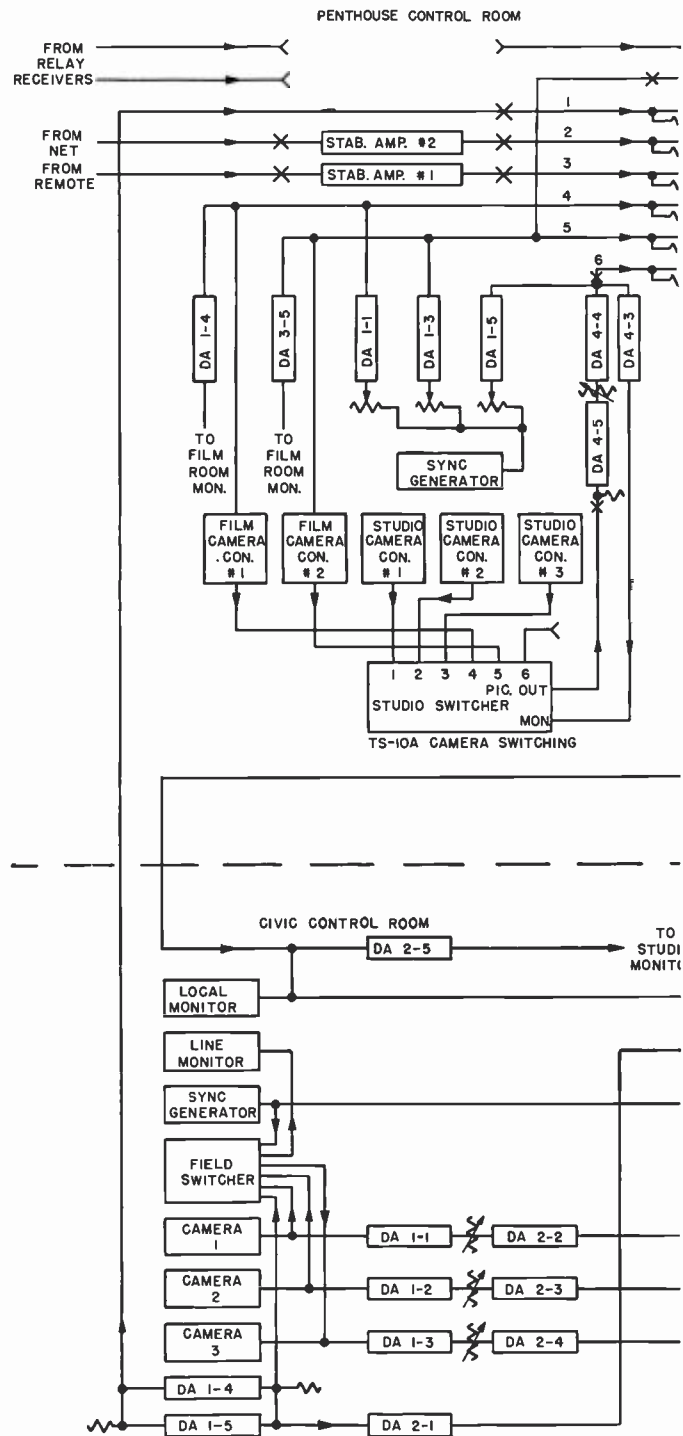

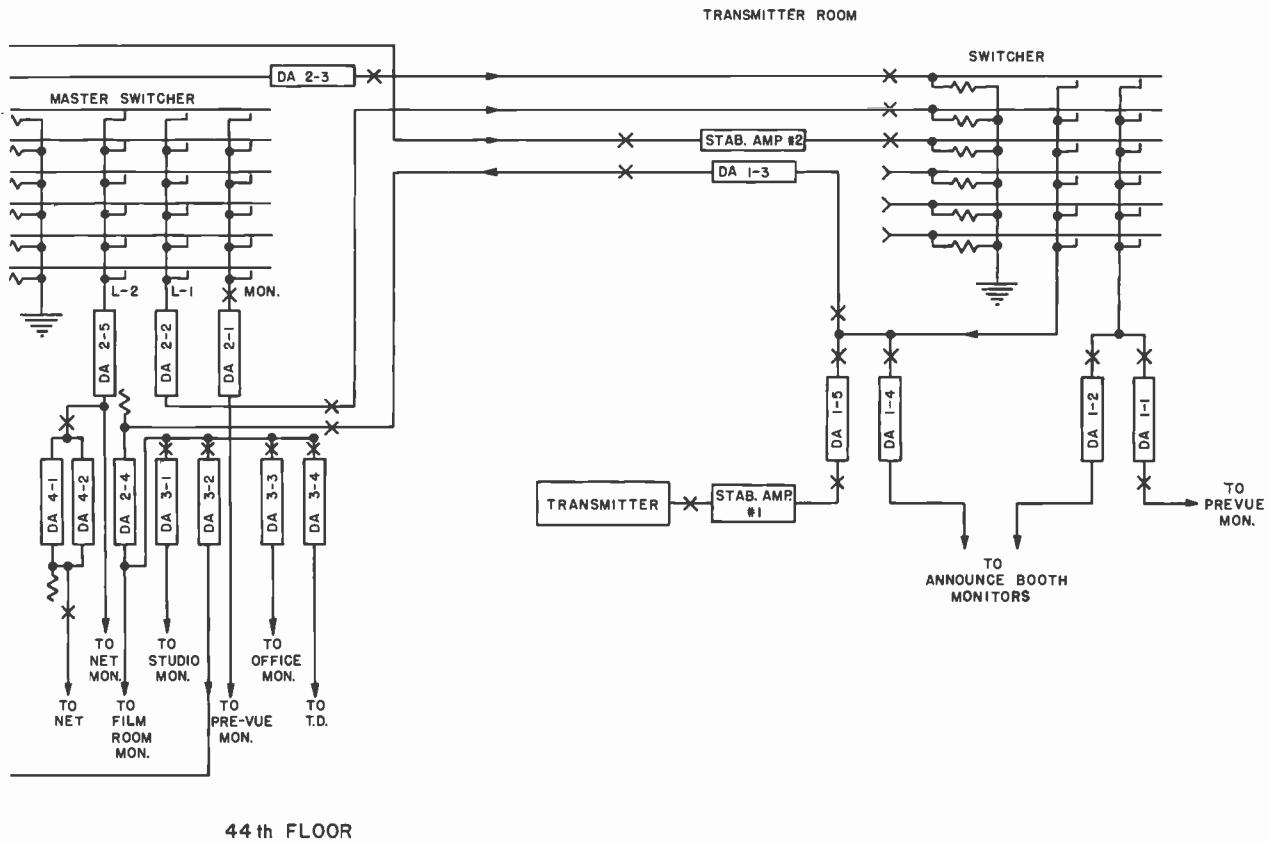

CIVIC STUDIO (STREET LEVEL)

CIVIC PRODUCER'S BOOTH

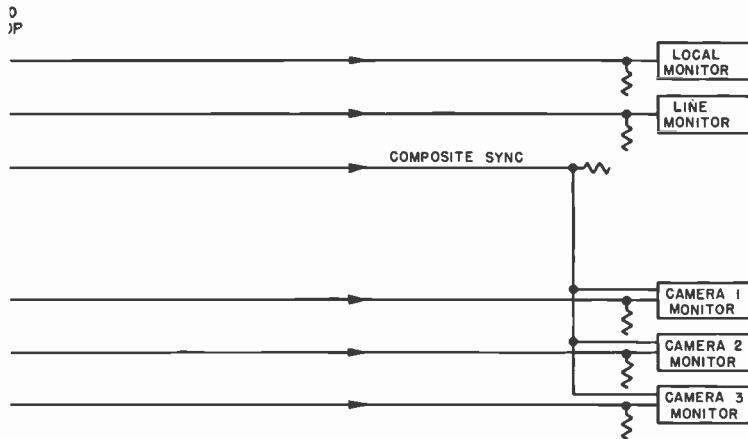

NOMENCLATURE

- DA - DISTRIBUTION AMPLIFIER
- STAB. AMP. - STABILIZING AMPLIFIER
- VIDEO JACK
- TWO VIDEO JACKS WITH NORMALLING PLUG
- 75 OHM TERMINATION
- VARIABLE TERMINATION
- BRIDGING POT.

NOTE: BLANKING & DRIVING LEADS ARE NOT SHOWN

FIG. 22. This is a simplified block diagram of WENR-TV's video facilities. Master control facilities are combined with the control room facilities for Penthouse Studio on the 44th floor. Incoming lines from net, relay and auditorium studio, as well as local cameras are brought to a rack-mounted master switching unit in the Penthouse Studio control room. At this any one of the five inputs may be "punched-up" for transmission to any one of three outgoing lines (networks, transmitter and monitoring circuits). A similar switching is provided in the transmitter control room so that, if desired, the Penthouse Studio may be shut down and all operations conducted from the transmitter. (Note error in the diagram above. The output of the "Field Switcher" in the Civic Control Room should go to DA 1-4 and DA 1-5 rather than to DA 1-3, as shown.)

WENR'S TV and FM ANTENNA

WENR-TV ANTENNA

The WENR-TV antenna is an RCA six-bay Super Turnstile, mounted on top of a four-section RCA heavy duty Pylon (which radiates the FM signal of WENR-FM). This combination TV-FM antenna is a self-supporting structure mounted directly on the roof of the building. As the height of the Civic Opera Building is 550 feet, a satisfactory antenna height is obtained without the use of a tower. The TV antenna is 668 feet above the street, making it the highest structure in Chicago.

Installation of the antenna assembly, which weighs approximately 5 tons, was accomplished by first erecting a tower-like staging above a hole cut in the roof of the building. The FM and TV antenna sections were then lifted, one section at a time, through the hole in the roof; and stacked one above the other on a steel supporting structure welded into the building framework under the roof. A total of 6 sections were handled this way: the four Pylon sections; a dummy support section (which also provided extra height); and the entire 47-foot long Super Turnstile.

The entire antenna assembly was brought up to the 45th floor in the Opera Building elevator. The Super Turnstile pole was shipped from RCA in five sections. These five sections were assembled and welded, and the batwings and their branch feed lines were attached on the 45th floor, prior to lifting the antenna through the roof. The $1\frac{3}{8}$ inch rigid coax transmission lines for FM and TV were installed and connected after erection of the antenna was completed.

The six-bay TV Super Turnstile provides WENR-TV with an effective radiated power of 25 KW from the 5 KW TT 5-A Transmitter. The antenna is well above surrounding buildings, eliminating any shadows in the service area.

FIG. 23 (left). This is a closeup of WENR's FM and TV antenna combination. The bottom cylindrical unit is a specially-made supporting section, the lower end of which is anchored in the building (see Fig. 26). Above this is a 4-section RCA Pylon which is the FM antenna. On top of this latter is the six-bay RCA Superturnstile which radiates the TV signals. The Pylon has a gain of 6, the Superturnstile, a gain of 7. Because of the height of the building itself (550 ft.) these antennas could be mounted directly on the roof, thereby obviating the expense of a tower.

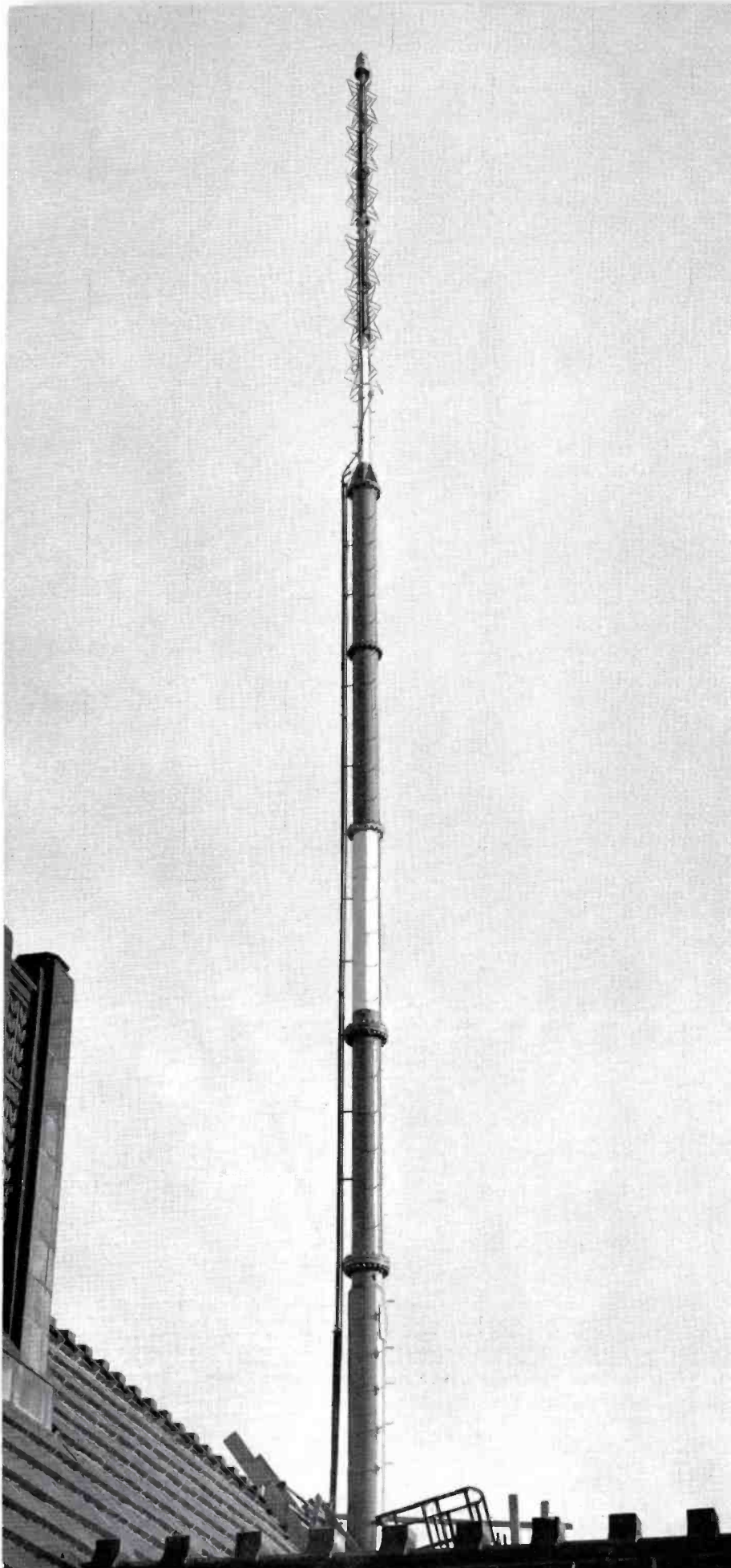



FIG. 24 (above). Erecting the antenna on the roof of the building was quite a problem. It was solved by building a tower-like scaffolding above a hole cut in the roof and bringing the sections up through the center of the scaffold.



FIG. 25 (above). The Pylon sections were brought up one at a time. As each one was brought up it was stacked on top. Finally the Superturnstile was brought up (in one piece) and placed on top.



FIG. 26 (right). In order to secure the antenna supporting section onto the building the framework of the latter was reinforced and the welded steel frame shown here was mounted within.



TELEVI

by RALPH V. LITTLE, JR.

Nearly one quarter of a million feet of motion picture film is being devoted each week by the television stations in New York City to record the television programs and commercials being broadcast. These motion picture recordings, made by photographing the visual images on special kinescopes with specially adapted cameras, are being made by broadcasters for many important reasons, chief among which are the following: to record programs for delayed broadcast to larger evening audiences; to record programs for documentary, historic, legal, and advertising purposes; for syndication of television programs to remotely located network stations; and for rebroadcast of programs because of differences in time zones.

To make possible kinescope recordings of rebroadcast quality, RCA developed special equipment which is already in operation in many of the key network stations. The RCA television recording system includes a high quality photographic monitor which produces precision visual images, a motion picture camera especially designed for photographing television pictures, and the equipment for sound recording which can be accomplished simultaneously with the picture recording in the camera. As an alternative sound may be recorded separately by using a double film system with separate recording equipment.

A glance at the simplified block diagram of the RCA photographic monitor will help explain more graphically the functioning of the system. Beginning at the upper left corner of Fig. 3, standard RMA video signals are supplied directly to the equipment from the studio coaxial lines in the television studio.

The signal is fed to a video amplifier where it is amplified and separated for the two basic functions of a television system: a signal for synchronizing the scanning

FIG. 1. The unretouched enlargements, at left, made from 16mm film recordings, of various television programs, show the clarity and definition of the RCA Kinephoto recording equipment.

VISION FILM RECORDING

raster of the kinescope with the television pickup camera; and a modulating signal which is amplified and used to control the kinescope beam which forms the visual image. The synchronizing signals control the deflection amplifier, which in turn supplies deflection power to the deflection yoke on the kinescope. A high voltage supply of 25 kilovolts is required for the kinescope operation and a regulated power supply furnishes necessary plate voltages to all units. The controls functions of the equipment are grouped on a centrally located panel with metering circuits to indicate proper operating adjustments.

The kinescope, RCA Type 5WP11, is a special 5-inch flat face aluminized projection type cathode-ray tube having a short persistence blue phosphor screen of high actinic value which makes possible the use of high resolution low-cost positive type film stock.

The equipment has been designed and manufactured to the high quality standards set by the broadcast industry.

The Camera

The 16 mm motion picture recording camera was developed by RCA especially for use in television to compensate for the timing differences in the television system which has a frame frequency of 30 per second and the conventional motion picture system which exposes film at the rate of 24 frames per second.

To understand how the conversion in exposure is made from the conventional to the television system frame rate, reference is made to Fig. 5. The figure is divided into intervals of $1/60$ of a second, representing the television field frequency. Since the $1/24$ second frame is $2\frac{1}{2}$ times $1/60$, five television fields represent $1/12$ of a second or $2/24$ of a second which is the

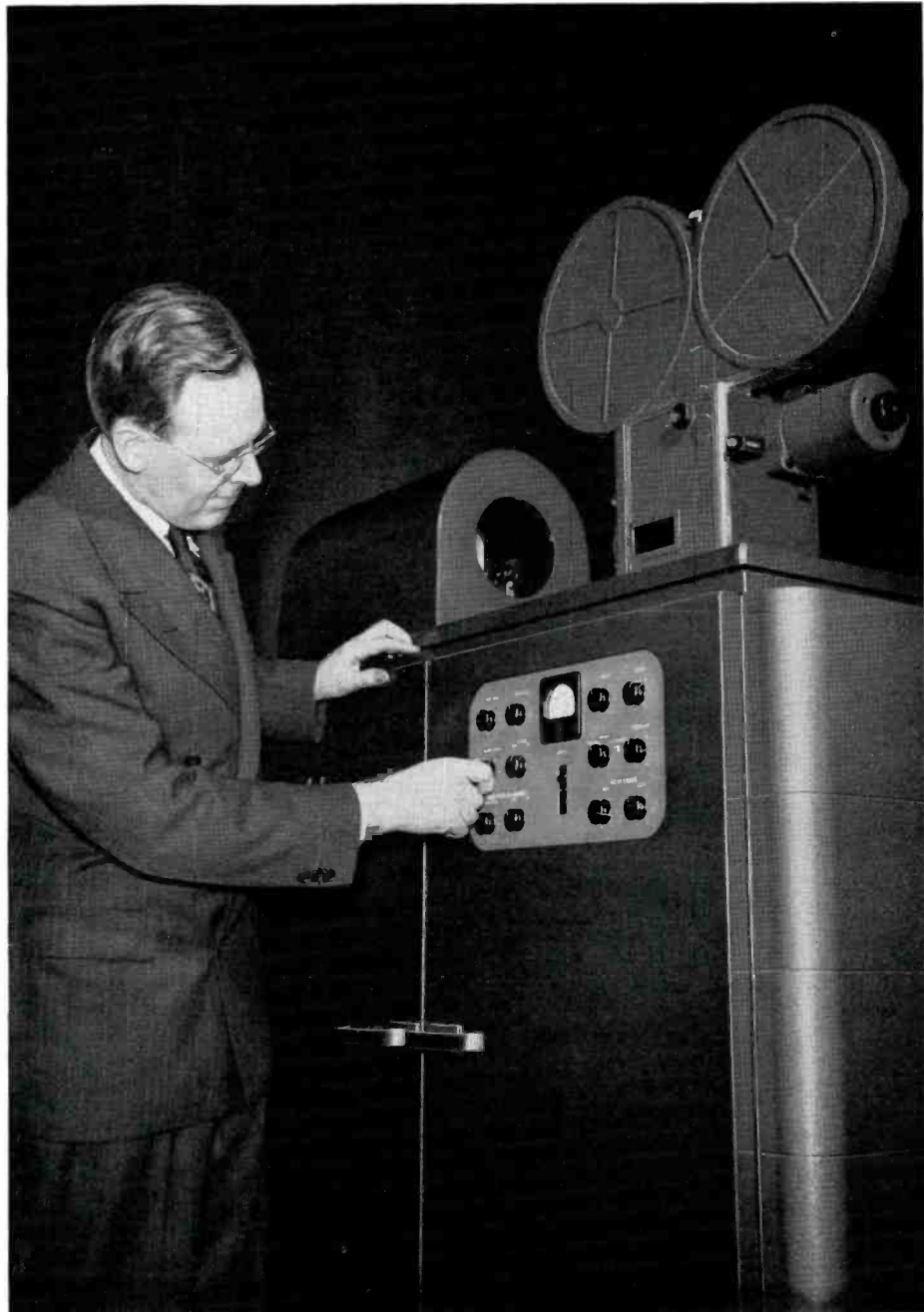

FIG. 2. R. V. Little, Jr. is shown adjusting the controls of the RCA Kinephoto Equipment. The unit shown is one of the earlier models. The control panels in newer units are equipped with built-in oscilloscopes which enable monitoring of the picture waveform.

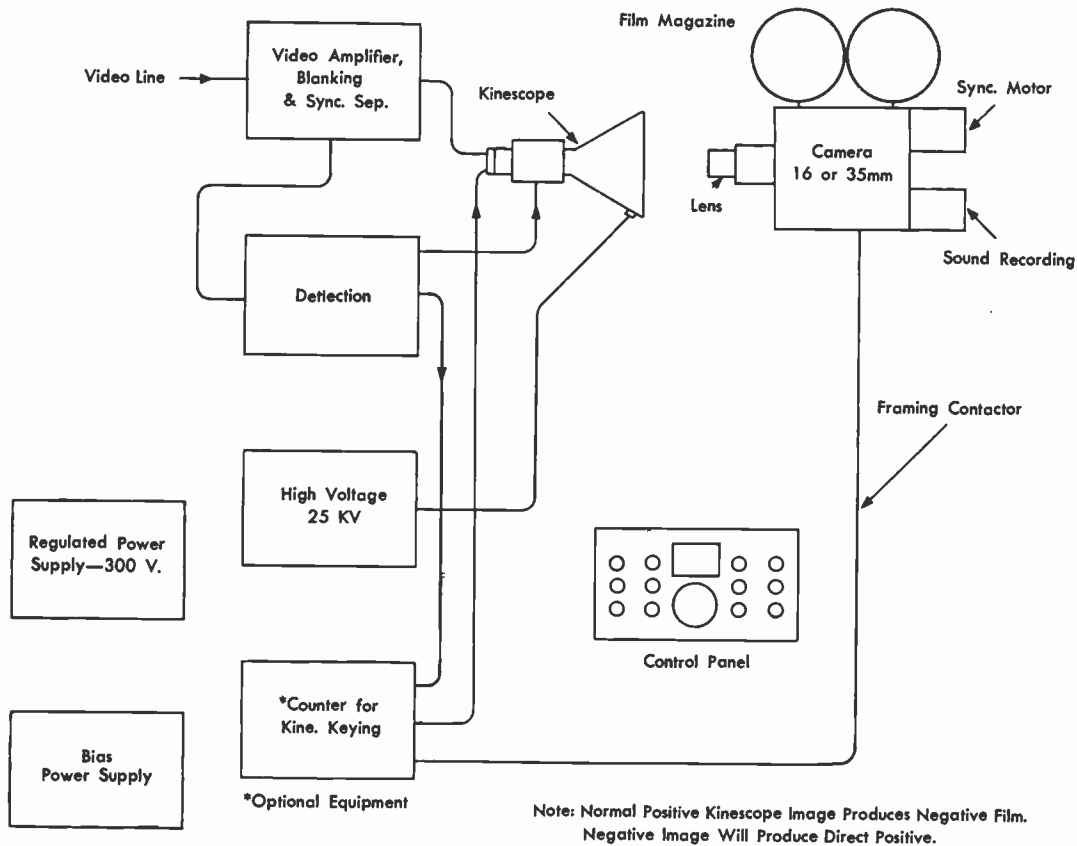

FIG. 3. This is a simplified block diagram of the RCA Kinephoto Equipment which consists basically of a projection kinescope and its associated video amplifiers, deflection circuits, power supplies, and a special camera for making film recordings.

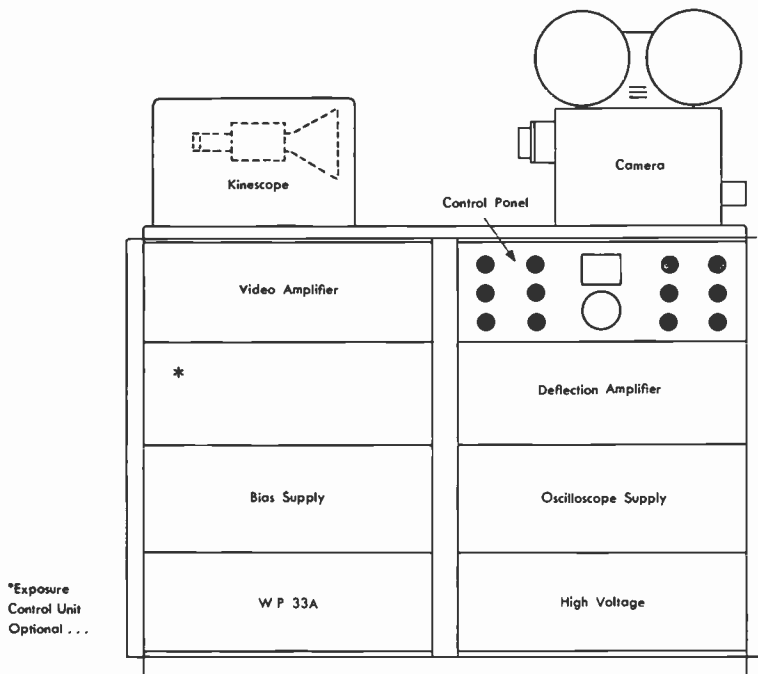

FIG. 4. This line drawing of the RCA unit shows the layout of the various components which are mounted in the double cabinet racks. An electronic exposure control unit is supplied as optional equipment.

time interval of two motion picture frames. The problem then is to fit the exposure and film transport of two film frames into five television fields. If we expose the film starting at field "A" and continuing to the end of field "B," we have one exposure of $1/30$ of a second, a complete interlaced television frame. Two fields of the television picture have been used and two more are required for a second exposure, leaving one field out of five to be used for two film transport intervals. This means that half a field, or $1/20$ of a second is available for each film pull-down.

Following the first exposure, allowance is made for the pull-down interval which is the middle of the next television field "C". It is here that the exposure must begin and continue for another television frame of $1/30$ of a second; this is the middle of field "E". Pull-down of the film follows to complete the cycle.

The camera is of professional quality throughout and every effort has been made to produce the finest camera for this service.

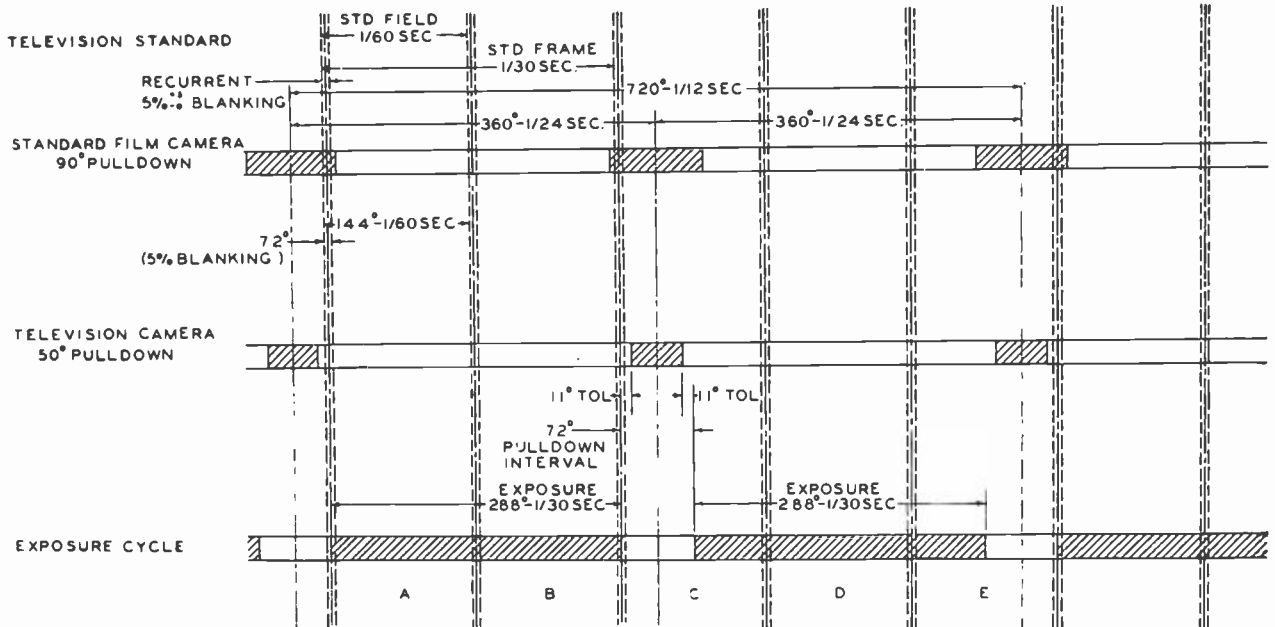

FIG. 5. The chart above shows a comparison between the exposure and pull-down timing of a conventional motion picture camera and a special camera designed to accommodate the television field rate. Note, the exposure in the special camera occurs between TV pull-down intervals which take place twice in every five fields.

Exposure

The camera exposure time in terms of the television system must be accurate to less than one half of a scanning line or roughly one part in 30,000. It must be timed to expose exactly the proper number of picture lines for each frame, or 525 lines, no more or less, or an effect known as "banding" will take place on the exposed film. This exposure is controlled by either of two types of shutters, mechanical or electronic.

Mechanically, the camera and shutter are driven by synchronous motors which are in synchronism with the entire television system. The shutter drive which is isolated from the main camera drive is driven by a 3600 rpm synchronous motor which drives the shutter at the necessary 1440 revolutions per minute through a set of precision gears. Another motor, working in synchronism with this, drives the film transport and intermittent mechanism. This arrangement insures rotational accuracy and freedom from inter-action of the camera drive and shutter drive mechanisms.

The alternative method of exposure control available is accomplished electronically. In this system, the exposure is controlled by biasing the kinescope image on and off by a special blanking signal. This method eliminates the need for the

moving camera shutter and substitutes an exposure control circuit which is initiated by a contact on the camera operating in proper phase relationship with the film transport which closes after the pull-down is complete.

In operation, the contact closes when the film has been transported and registered. Then the exposure control circuit removes the cut-off, bias from the kinescope which permits a picture to appear on the tube and produces exposure of the film. The control circuit, which is actuated by the horizontal driving pulses counts 526 lines (that is to the end of the 525th line) returning the kinescope bias to cut-off, this action removes the picture image and ends the exposure.

The electronic system does not require synchronization between the camera and the television signals. The incoming video signal supplies the keying information so the position of the blanking of the kinescope can change in phasing, but the exposure duration will always be correct because the information is obtained from the television signal. A small change in speed between incoming signals merely displaces subsequent exposure periods.

The density of film recording depends not only on the length of exposure but on the brightness of the cathode-ray picture

tube. Since the exposure time is fixed, the highlight brightness of the picture is varied by means of the video gain control; the kinescope bias control will set black level or point of visual extinction of the return lines. The beam current of the picture tube is measured by a microammeter on the control panel of the monitor; since there is a direct relationship between the light output of the tube, the measurement of the beam current provides a good index to the brightness of picture.

Normally, motion pictures taken of the positive kinescope images on standard film produce negative images which can be used for rebroadcast by reversing the video phase in the film camera. The film negative is then available to produce as many prints as desired. For applications where direct projection is required, such as in theatres, a polarity switch makes it possible for kinescope to produce negative images. Such images can be photographed and processed as direct positives for immediate projection. RCA has found that with special processing equipment, it is possible to take pictures and project the finished pictures on the motion picture screen, in 40 seconds. Using this technique, theatres could take pictures "off the air", rush them through processing and show them on the screen as newsreels.

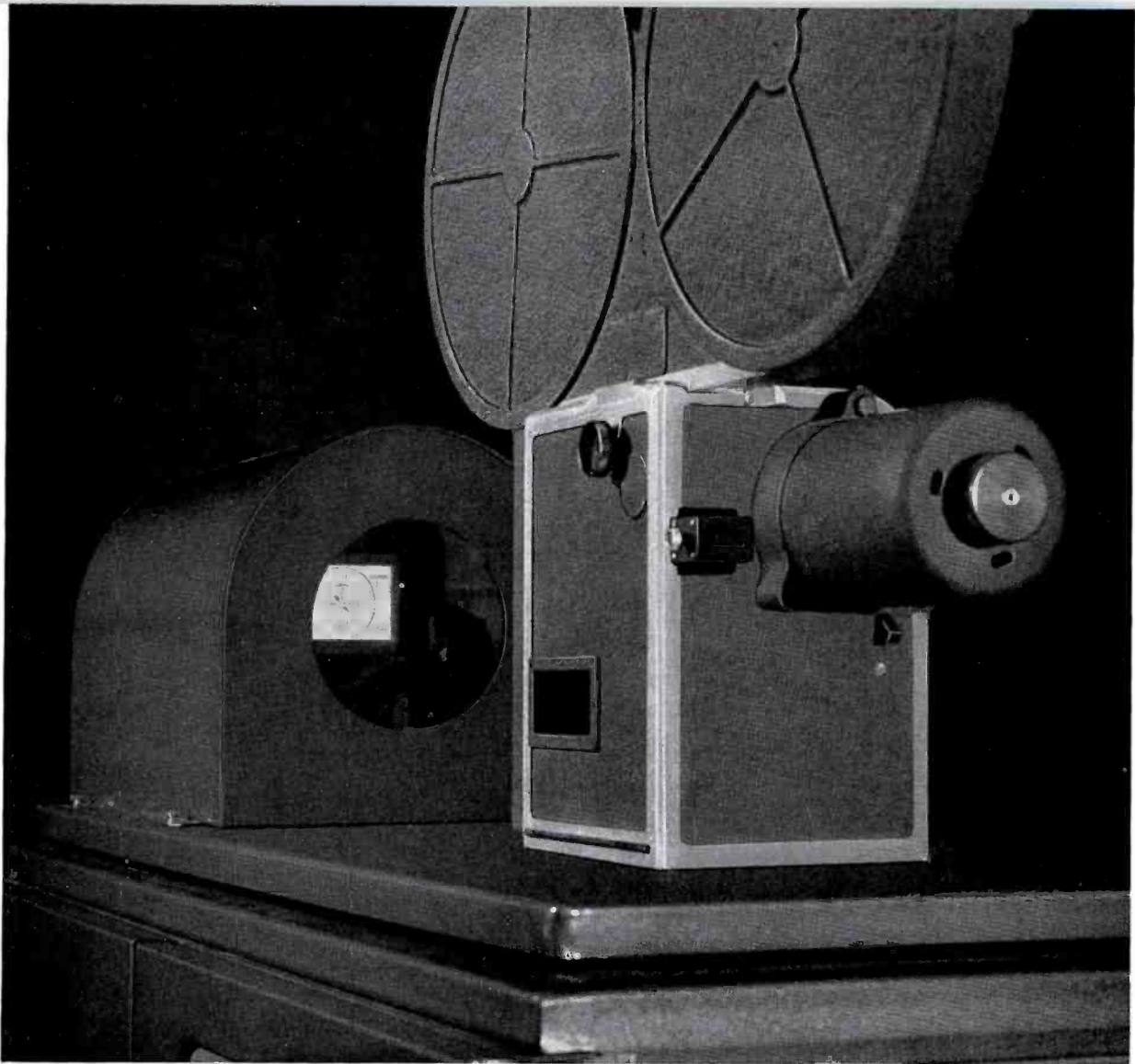
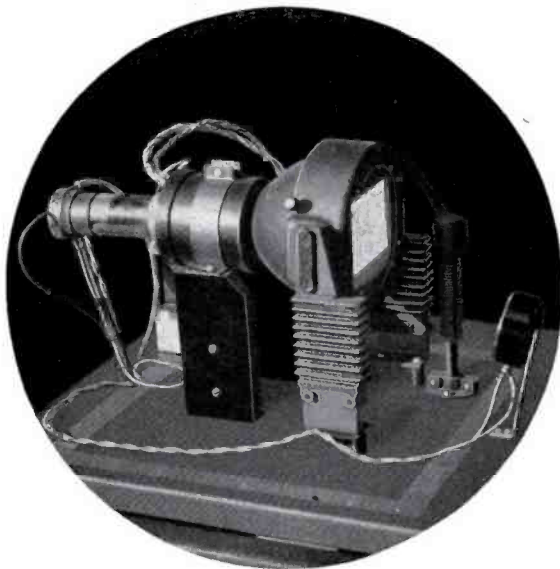

FIG. 6. The photo above shows a closeup of the RCA 16mm television camera which accommodates 1200 feet of film and which can be equipped for making simultaneous sound and film recordings. Either a 16mm or 35mm motion picture camera can be used to photograph the images appearing on the face of the projection type kinescope.



Either 16mm or 35mm motion picture cameras can be used with the RCA television monitoring equipment. 16mm film has been chosen initially for television recording because of the importance of costs of the film stock and the film processing together with the safety problems involved. The handling of 35mm film requires elaborate safety precautions because of the rigid fire regulations in the handling of this type of film. RCA engineers have found that 16mm fine grain films with suitable processing can produce excellent picture quality and since the costs involved are approximately 1/3 of the 35mm film, the use of 16mm film is felt well justified. When it is realized that it takes 1200 feet of film to record a half-hour performance, cost of film and developing becomes an important factor to consider. This is primarily why RCA produced the 16mm motion picture cameras for the television industry.

FIG. 7. Picture at left shows the television projection tube assembly with the kinescope shield removed. Shown are the projection kinescope, RCA Type 5WP11, the kinescope and deflection yoke assemblies, and the insulator tube supports. The photonic cell mounted at extreme right of kinescope face is connected with meter in control panel and provides a relative indication of the tube's light output.

THE PHILOSOPHY OF OUR TV SYSTEM

A Brief Review of the Functions of the Most Important Parts of the TV System, With An Explanation of the Reasoning Behind the Choice of Standards, Type of Transmission, Shape of Synchronizing Pulse, Etc.

by JOHN H. ROE

Supervisor
TV Systems Engineering Group
Engineering Products Department

PART II

EDITOR'S NOTE: *The first part of this article appeared in BROADCAST NEWS No. 53, February, 1949. The second part is included in this issue. The third, and concluding, part will be published in the next issue of BROADCAST NEWS, which should be mailed about June 1. Those desiring to have the whole article in advance may obtain a preprint by writing to the editor.*

The D-C Component of the Picture Signal

The visual and aural senses differ in one important respect which places a requirement on the television transmission system which has no counterpart in the sound transmission system. The response of the ear to sound is actually a response to variations in air pressure. While the ear is very

sensitive to rapid variations in pressure, it is completely unconscious of absolute values of air pressure, or of slow variations in pressure, as sound. In other words, there is a definite low limit to the frequency of pressure variations which the ear accepts as sound. Therefore there is no need for a sound transmission system to pass frequencies below the aural limit which is somewhere in the neighborhood of 15 cycles per second. The circuits may be a-c coupled without loss of essential information. Even the best of practical systems have a low frequency cutoff at about 30 cycles, and most others cut off somewhere between 50 and 100 cycles.

The eye, on the other hand, is sensitive to absolute intensities of light and to slow variations of intensity. As the frequency of variation increases, the eye rapidly loses its ability to follow the changes and tends to produce a sensation which is an average of the variations. It is this averaging ability that enables the eye to interpret a rapid succession of still pictures as a portrayal

of smooth motion. This phenomenon is the basis of both motion picture and television systems.

The important point in the present discussion is that the eye recognizes a slow change in light intensity. The period of the change may be a fraction of a second or it may be a minute, an hour, or a half day in length. A television system must be capable of conveying these slow changes, no matter how long the period, to the receiver. The rapid scanning of the image of the scene in the camera produces a signal containing these slow changes as well as very rapid variations caused by the passage of the scanning beam over small light and dark areas of the image. The slow changes often have periods so long that they may be considered as d-c levels which simply change value occasionally. Hence, the signal is said to contain a *d-c component*. The television system must either pass the entire spectrum, including the d-c component, in each of its stages, or the signal must contain such information that it will be possible to restore the d-c component, which would be lost in an a-c coupled system, when it finally arrives at the reproducer. Because of the well-known difficulties in constructing multistage d-c coupled amplifiers, it is obviously desirable to use an a-c coupled system. It is fortunate that relatively simple means are known for d-c restoration thus making possible the use of an a-c coupled system.

Fig. 6(a) illustrates a signal which contains a d-c component in the form of a temporary change in the amplitude of the pulses. The period t_1 embracing the low-amplitude pulses may be of any arbitrary length. The original signal is characterized by the constant level of the negative peaks of all the pulses regardless of amplitude. After passing through an a-c coupled system (in which the time constants of the coupling networks are short compared to the period t_1) the signal becomes distorted approximately as shown in Fig. 6(b). Here the negative pulse peaks no longer fall on a constant level, but the signal tends to

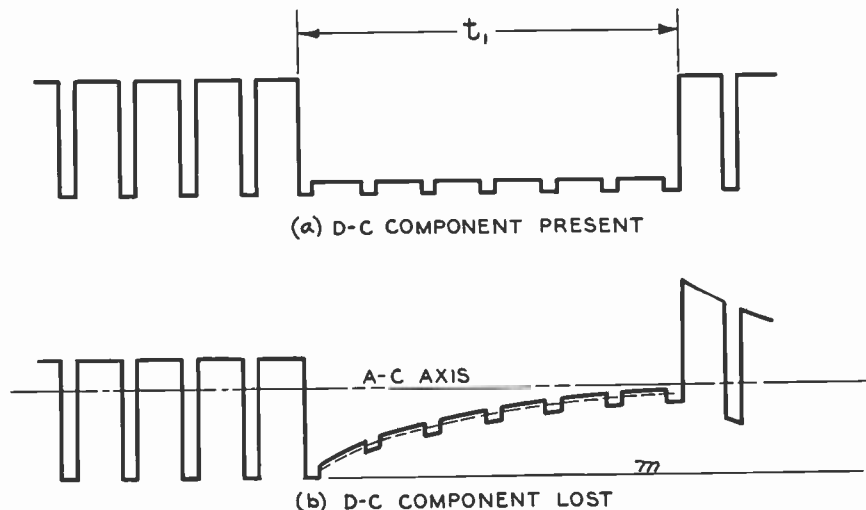

FIG. 6. When a signal containing a d-c component, as in (a), is passed through an a-c coupled system the d-c component is lost, as shown in (b).

adjust itself in a consistent manner about an axis called an a-c axis.

The a-c axis of a wave is a straight line through the wave positioned so that the area enclosed by the wave above the axis is equal to the area enclosed by the wave below the axis. The broken line marked a-c axis in Figure 6(b) is actually the correct axis only for a wave composed of large pulses like the first four at the left. During the transient condition following the first short pulse, the line shown is not the true a-c axis, but represents the operating point of the amplifier in the a-c coupled system. The actual a-c axis of the short pulses (shown by the dotted line) gradually adjusts itself to coincide with the operating point of the amplifier. This adjustment is shown by the exponential rise of the signal during the interval t_1 , but it is interrupted before completion by the resumption of the large pulses. Thence a second transient condition takes place leading to a gradual restoration of the signal to its original form.

The departure of the pulse peaks from the original constant level indicated by the line m , is called *loss of the d-c component* or loss of "lows". It is interesting to note that this loss causes an increase in the peak-to-peak amplitude of the signal, a condition which is undesirable, especially in high-level amplifiers.

Black Level

An absolute system of measurement must have a fixed standard reference unit or level. This rule applies to the problem of reproducing absolute light intensities. The simplest and most obvious reference for such a system is zero light, or *black level* as it is often called. This is a reference level which can be reproduced arbitrarily at any point in the system. Now if the television signal can be synthesized in such a way that frequent short intervals have some fixed relationship to actual black in the scene, then it becomes possible to restore the d-c component by forcibly drawing the signal to a fixed arbitrary level during these intervals.

D-C Insertion and D-C Restoration

Because the blanking or retrace periods are not useful for transmitting actual picture information, they offer convenient intervals for performing special control functions such as d-c restoration as mentioned in the previous paragraph. If the peaks of the blanking pulses are coincident with black level, or differ from black level by a constant amount, then d-c restoration can be accomplished simply by restoring

these peaks to an arbitrary reference level. Thus, in Fig. 6(b), if the peak of each pulse can be restored to the line m , then the signal will appear as in (a) and the d-c component will have been restored. Small errors will remain corresponding to the displacements in level between pulses, but these are usually negligible and in any case do not become cumulative. Hence the restoration is essentially complete.

It now becomes apparent that an extremely important step in the synthesis of the television signal is that of making the peaks of the added blanking pulses bear some fixed relationship to actual black level in the scene. It was pointed out previously that the peaks of these pulses are produced by clipping off unwanted portions of the signal as illustrated in Fig. 4, C and D. A second, and most important, function is performed when the clipping is controlled in such a way that the resultant peaks have the required fixed relationship to black level. This process of relating the blanking peaks to actual black level is called *d-c insertion*, or insertion of the d-c component. A subsequent process, later in the system, of bringing these peaks back to an arbitrary reference level is called *d-c restoration*. D-c restoration must be accomplished at the input of the final reproducing device (the kinescope) in order to reproduce the scene faithfully if an a-c amplifier is used. It is desirable to restore the d-c component at other points in the system also, because the process reduces the peak-to-peak excursions of the signal to a minimum by removing increases in amplitude caused by loss of the d-c component. In a similar way, it is possible to remove switching surges, hum, and other spurious signal components which have been introduced by pure addition to the

signal. Maintaining minimum excursion of the signal is important, especially at high level points in the system, in order to avoid saturation in amplifiers and consequent distortion of the half tones in the scene. For a specific example, d-c restoration helps to maintain constant sync. amplitude in high-level amplifiers. In other words, it makes possible economies in the power capabilities of amplifiers such as the final stage in the picture transmitter.

Diagram 3 in Fig. 5 illustrates part of a typical picture signal including two horizontal blanking pulses. It may be seen that there is a distinct difference between actual black level and blanking level which is prescribed as 5% of maximum blanking pulse amplitude. This difference is usually called *setup* and its magnitude was set as a reasonable compromise between loss of signal amplitude range and the need for a tolerance in operating adjustment. Setup is desirable as an operating tolerance in the initial manual adjustment of the clipper in that part of the system where the d-c is *inserted*. It simply insures that no black peaks in the actual picture signal are clipped off.

The accuracy with which setup is maintained depends on characteristics of the pickup or camera tube. Some types of pickup tubes produce signals during blanked retrace periods which are the same as, or are constantly related to, black level. In systems where such tubes are used, the magnitude of setup may be held constant automatically at whatever value is determined in the initial manual adjustment of the clipper circuit. In general, pickup tubes employing low velocity scanning, such as the image orthicon, provide this kind of basic black level information. The iconoscope is different from orthicons in this respect because the secondary emission resulting from the high velocity scan-

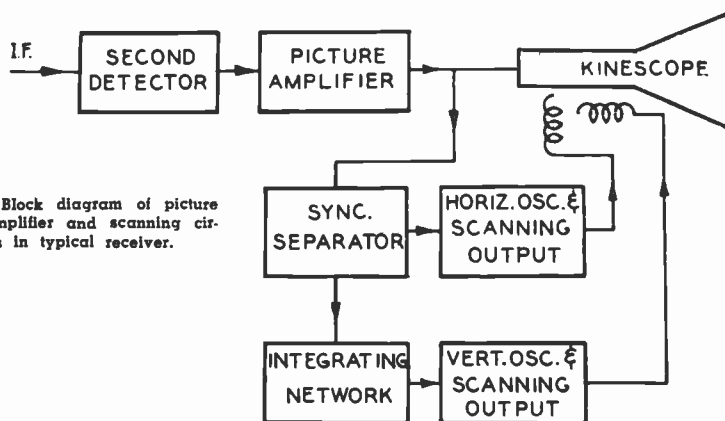

FIG. 7. Block diagram of picture signal amplifier and scanning circuits in typical receiver.

ning, produces a potential distribution on the mosaic in which black level is far from the level existing during the retrace periods when the beam is cut off. In fact the difference between black level and blanking level varies continuously as the scene brightness changes because the potential distribution caused by resettling of the secondaries likewise changes. Automatic maintenance of setup, or pedestal height, cannot therefore be obtained by reference to the signal during blanked retrace periods in the iconoscope, but may be obtained by reference to actual black peaks in the picture signal. Where such reference is not practical, a manual control may be re-adjusted from time to time to keep the setup at the required value.

Synchronizing

The horizontal and vertical scanning circuits in a receiver are two entirely independent systems both of which require extremely accurate information to keep them in step with the corresponding scanning systems in the camera where the signal originates. Because the duration of sync. pulses may be rather short, they may be added to the picture signal in such a way as to increase the overall amplitude of the final signal without increasing the average transmitted power level very much. Thus, simple amplitude discrimination can be used to separate the synchronizing information from the incoming composite signal in the receiver. It is, however, desirable that a second increase in amplitude should not be used to distinguish between horizontal and vertical sync. One reason for this is that a further increase in signal amplitude would make necessary an increase in the peak power rating of the transmitter or else would unnecessarily restrict the power available for the picture and horizontal sync. portion of the signal.

A synchronizing system has therefore been chosen in which both vertical and horizontal pulses have the same amplitude, but different waveshapes. Frequency discrimination may then be used to separate them in the receiver. The shapes of these pulses and their relation to the blanking pulses are illustrated in detail in Fig. 5. Fig. 7 is a functional block diagram showing the steps necessary to utilize the sync. signals.

Diagrams 1 and 2 of Fig. 5 illustrate a typical complete composite picture signal in the neighborhood of the vertical blanking pulse in each of two successive fields. Interlacing of the scanning lines is shown by the time-displacement of the horizontal blanking pulses in one diagram with respect to those in the other diagram. This dis-

placement is one half of the interval of a scanning line ($H/2$).

All sync. pulses appear below black level in an amplitude region which is sometimes called *blacker-than-black*; hence they can have no effect on the tonal gradation of the picture. Horizontal sync. pulses are (except during the first portion of the vertical blanking interval) simple rectangular pulses such as those appearing at the negative peaks or bases of the horizontal blanking pulses and during the last portion of the vertical blanking pulses. The duration of a horizontal sync. pulse is considerably less than that of the blanking pulse, and the leading edge of the sync. pulse is delayed with respect to the leading edge of blanking, forming a step in the composite pulse which is called the *front porch*. Correspondingly, the step formed by the difference between the trailing edges of sync. and blanking is called the *back porch*. The purpose in forming the front porch is to insure that the horizontal retrace in the receiver (initiated by the sync. pulse) does not start until after the blanking pulse has cut off the scanning beam. It also insures that any discrepancies which may exist in the leading edge of blanking do not affect either the timing or the amplitude of sync.

The choice of the nominal width of horizontal sync. ($0.08 H$, see diagram 5 in Fig. 5) was influenced by three factors. First, the width should be as great as possible so that the energy content of the pulses will be large compared to the worst type of noise pulses which may be encountered in the transmission process, thus providing maximum immunity to noise. Second, the width should not be greater than is necessary to meet the first condition because average power requirements of the transmitter may thereby be minimized. Modulation of the picture transmitter is such that sync. pulses represent maximum carrier power; hence it is desirable to keep the duty cycle as small as possible. Third, the horizontal sync. pulses should be kept as narrow as possible so as to maintain a large difference between these pulses and the segments of the vertical sync. pulses described in the following paragraph. Such a large difference makes it easier to separate the vertical sync. from the composite sync. signal. It has also been recognized that the back porch is useful for a special type of clamping for d-c restoration. Hence it should be as wide as possible.

Vertical sync. pulses are also basically rectangular in shape, but are of much greater duration than the horizontal pulses

thus providing the necessary means for frequency discrimination to distinguish between them. However, each vertical sync. pulse has six *slots* cut in it which make it appear to be a series of six wide pulses at twice horizontal frequency, i.e., wide compared to horizontal sync. pulses. The slots contribute nothing to its value as a vertical sync. pulse but do provide means for uninterrupted information to the horizontal scanning circuit.

Before and after each vertical pulse interval are groups of six narrow pulses called *equalizing pulses*. These also are for the purpose of maintaining continuous horizontal sync. information throughout the vertical sync. and blanking interval. The repetition frequency of the equalizing pulses and the slots in the vertical pulses is twice the frequency of the horizontal sync. pulses. This doubling of the frequency does two things. First, it provides an arrangement in which the choice of the proper alternate pulses makes available some kind of a horizontal sync. pulse at the end of each scanning line in either even or odd fields. Second, it makes the vertical sync. interval and both equalizing pulse intervals exactly alike in both even and odd fields. The importance of this latter result will become evident in following paragraphs. It is important to point out that the leading edge (downward stroke) of each horizontal sync. pulse and of each equalizing pulse, and the trailing edge (again the downward stroke) of each slot in the vertical pulses are responsible for triggering the horizontal scanning circuit in the receiver; hence the intervals of H or $H/2$ apply to these edges.

Perhaps the most difficult problem in synchronizing, and the one in which there is the largest number of failures, is that of maintaining accurate interlacing. Discrepancies in either timing or amplitude of the vertical scanning of alternate fields will cause displacement, in space, of the interlaced field. The result is non-uniform spacing of the scanning lines which reduces the vertical resolution and makes the line structure of the picture visible at normal viewing distance. The effect is usually called *pairing*. The maximum allowable error in line spacing in the kinescope to avoid the appearance of pairing is probably 10% or less. This means that the allowable error in timing of the vertical scanning is less than one part in 5000. This small tolerance explains why so much emphasis is placed on the accuracy of vertical synchronizing.

The presence of a very minute 30-cycle component in the *vertical* scanning in-

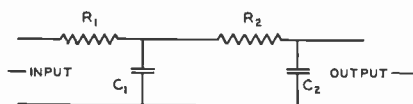

FIG. 8(a). Two-stage integrating network used to separate vertical sync. pulses from the composite picture. Circuit values are as follows:

$R_1 = 10,000$ ohms $R_2 = 200,000$ ohms
 $C_1 = .012$ mfd $C_2 = 150$ mmf
 $T_1 = 120$ ms $T_2 = 30$ ms

FIG. 8(b)* (right). General action of the integrating circuits in the region of the equalizing pulses and beginning of the vertical sync. pulse. Curves are identified as follows:

Curve acde is Synch. Signal in region of even field pulse
 Curve bcde is Synch. Signal in region of odd field pulse
 Curve f is curve acde "integrated" by circuit having $T = 120$ micro-sec.
 Curve g is curve bcde "integrated" by circuit having $T = 120$
 Curve h is curve acde "integrated" by two stages, having $T_1 = 120$ and $T_2 = 30$
 Curve i shows rate at which equalization occurs for $T = 120$

NOTE: In this diagram the slots in the vertical pulse are shown the same width as the equalizing pulses, whereas they are actually the same width as the horizontal sync pulses (see Fig. 5).

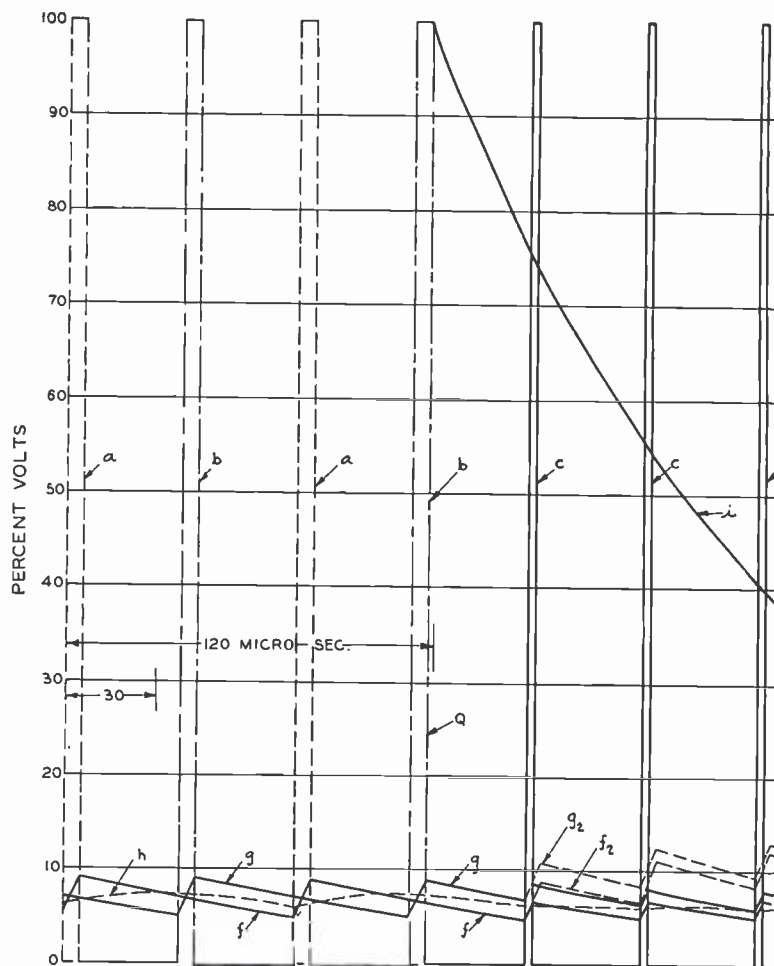

variably causes pairing. The fact that the rasters produced in alternate fields are displaced with respect to each other by half a line means that the *horizontal* sync. signal has an inherent 30 cycle component. It is this situation and the need to prevent any transfer of the 30-cycle component into the vertical deflection which account for the introduction of the double-frequency equalizing pulses before and after the vertical sync. pulses. The vertical sync. pulses are separated from the composite sync. signal, before being applied to the vertical scanning oscillator, by suppressing the horizontal sync. pulses in an integrating network similar to that illustrated in Fig. 8(a).

Most receivers employ integrating networks of three stages instead of the two illustrated. However, the general character of the circuit action is clearly shown by

the wave form diagrams in Fig. 8(b). In simple terms, the equalizing pulses before the vertical sync. pulses cause the integrating network to "forget" the difference between alternate fields by the time the vertical sync. pulses begin. This is illustrated by the gradual convergence of curves *f* and *g* during the equalizing pulse interval, as the result of integration in the first stage alone. The effect of further integration in the second stage is shown by curve *h*, which is typical of the pulses applied to the vertical oscillator in a receiver. Thus, the 30-cycle component is effectively eliminated, from the standpoint of accurate timing of the start of vertical retrace, by the addition of the first set of equalizing pulses and the slots in the vertical pulse itself. The second set of equalizing pulses which follow the vertical pulse affect to some extent the impedance of the circuit to which the vertical scanning oscillator is

coupled, and thus affect the amplitude of its output; hence these pulses help to provide more nearly constant output of the oscillator. Both sets of equalizing pulses contribute materially to the necessary accuracy of vertical synchronizing.

The width of an equalizing pulse is half the width of a horizontal sync. pulse (see diagram 4 of Fig. 5, and Fig. 8). This width is chosen so that the a-c axis of the sync. signal does not change at the transition from the line-frequency horizontal sync. pulses to the double-frequency equalizing pulses. The curves *f*₂ and *g*₂ in Fig. 8 illustrate the undesirable effect of making the equalizing pulses the same width as the horizontal sync. pulses. There is a slight rise in the integrated wave during the equalizing pulse interval which could cause premature triggering of the vertical oscillator in the receiver if the hold control were adjusted near one end of its range.

* Diagram prepared by A. V. Bedford, RCA Laboratories, for presentation to the N.T.S.C.

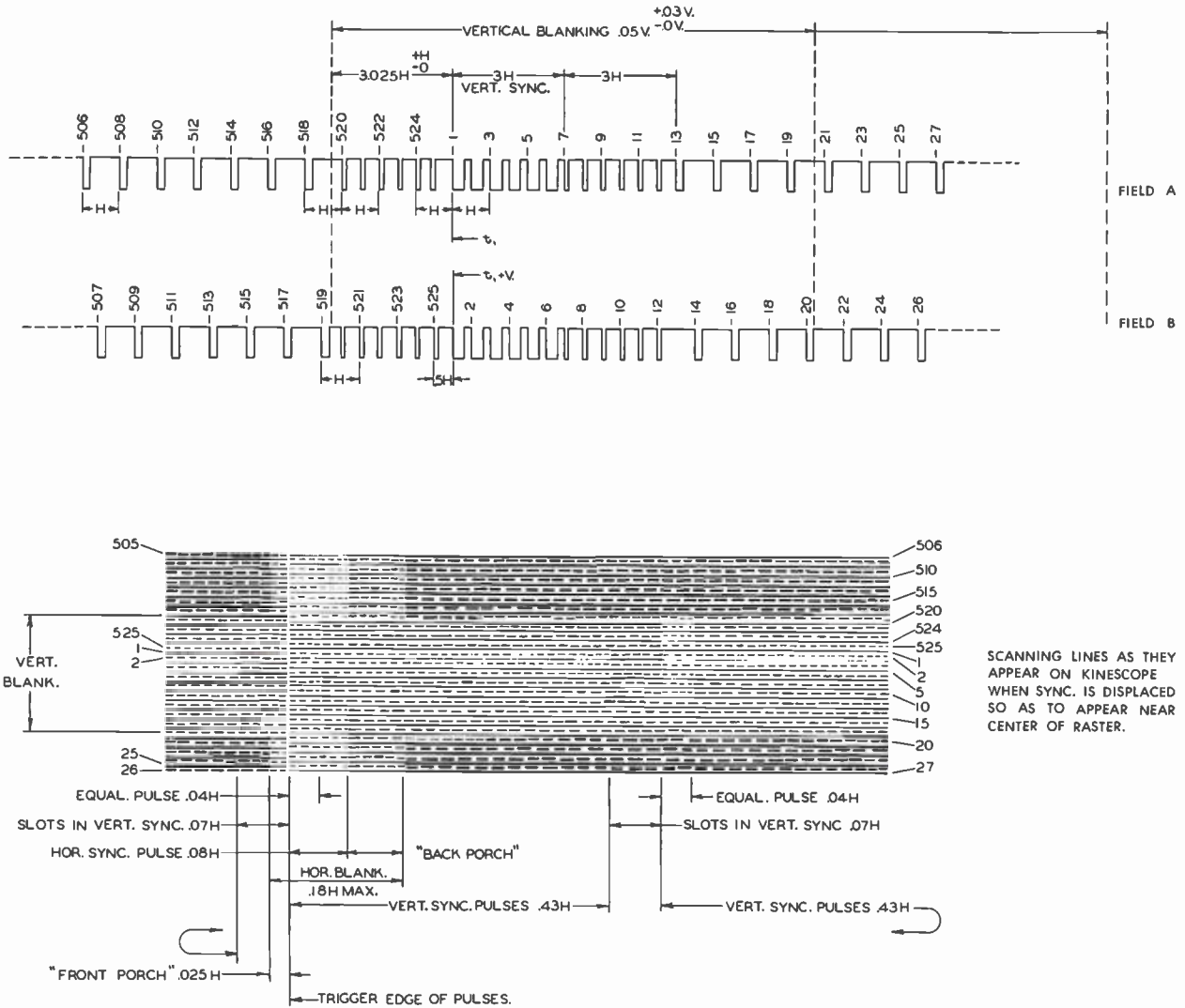

FIG. 9. A portion of the scanning lines appearing on a kinescope as a result of the application of a television signal composed of RMA sync. and blanking pulses. The group of lines shown are those occurring in the neighborhood of the vertical retrace period, including a few before and a few after the vertical blanking pulse.

ing pulses. The group of lines shown are those occurring in the neighborhood of the vertical retrace period including a few before and a few after the vertical blanking pulse. As noted on the diagram, the triggering of the lines has been displaced both vertically and horizontally so that the shadows produced by the sync. and blanking pulses appear near the center of the raster rather than in the normal positions at the edges of the raster. This displacement is brought about simply to clarify the illustration of the effect of the pulses on the raster.

The shadows produced thus are called a *pulse cross*. When expanded vertically so that individual scanning lines become easily apparent, the pulse cross becomes a ready means of checking the performance of the sync. generator. The shadows produced by each different kind of pulses are indicated clearly on the diagram. With linear scanning, the horizontal dimensions of the shadows are measures of time or pulse width, and, because of the expanded scale, they provide a relatively accurate means of measuring pulse width. Furthermore, by counting appropriate lines, the

numbers of equalizing pulses, slots, vertical sync. pulses, etc., can be checked easily.

A useful piece of station test equipment can be made by modifying the deflection circuits in a picture monitor to provide the displacement of the lines and the extra large vertical expansion described.

(THE THIRD, AND CONCLUDING, PART OF MR. ROE'S ARTICLE WILL APPEAR IN THE NEXT ISSUE OF BROADCAST NEWS)

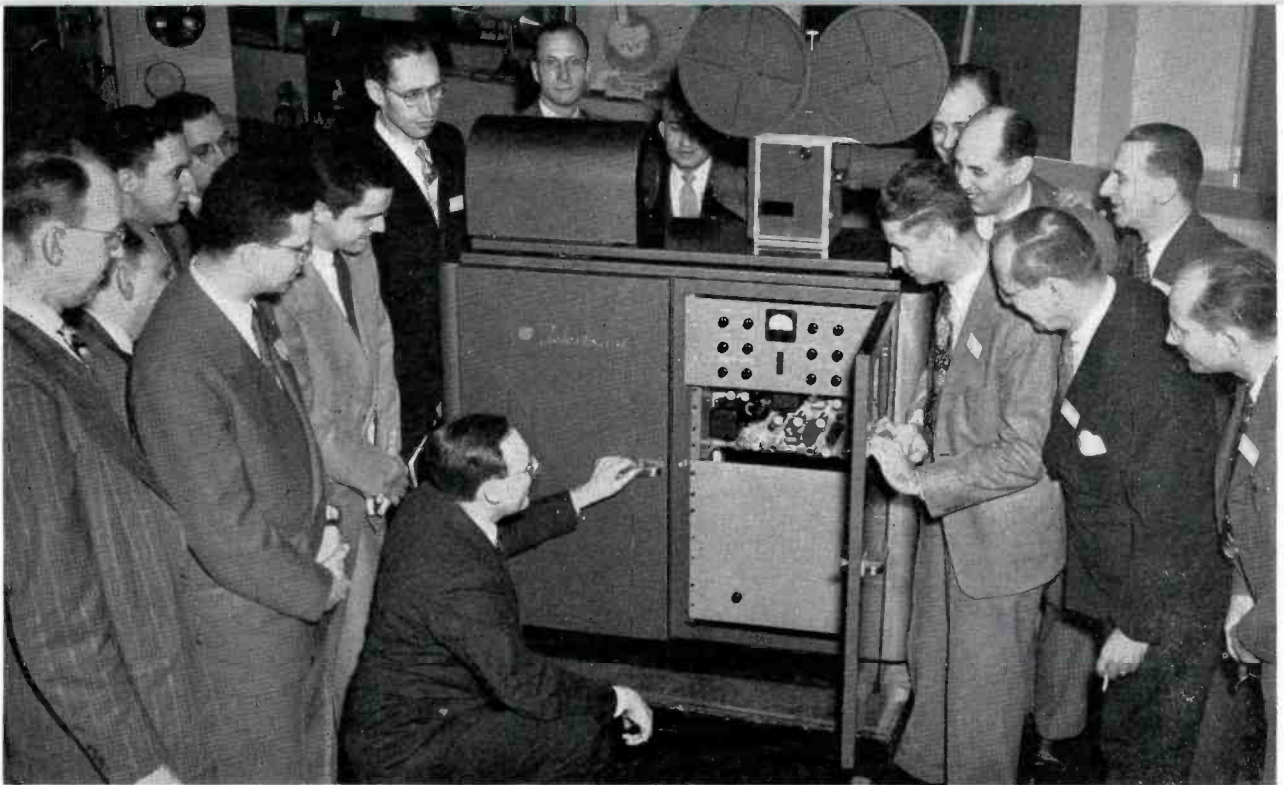

FIG. 1. During the week-long TV clinic, broadcasters saw a demonstration of an RCA Kinephoto Equipment which is used to record television programs.

BROADCASTERS COMPLETE SIXTH RCA TV CLINIC

Sixty-nine engineers enrolled in the sixth RCA Television Technical Training Program were awarded certificates by D. F. Schmit, Vice President in charge of Engineering, at closing sessions of a recent five-day clinic. The training course, sponsored by the RCA Engineering Products Department, brought broadcasters and engineers to Camden from all sections of the United States and Canada. Since the beginning of the series of technical clinics, nearly 400 engineers have received training in theory, design, operation, and maintenance of the latest television equipment.

In a closing address to the broadcasters,

T. A. Smith, General Sales Manager of the RCA Engineering Products Department, declared that "television has come of age and the mantle of glamor and accomplishment is passing from us, who developed television, to you in the stations who will use this great force for the benefit of the people."

Pointing out that television was "a long time a-borning"—that years of laboratory research underlie its present technical perfection—Mr. Smith said, "there is really nothing sudden about television now except the realization that it goes places and

does things. It is beginning to change the habits of the American people—their buying habits, their politics, their amusements, their thinking, and even their social habits. We suddenly have realized that we have in our hands an instrumentality of great power."

The week's training schedule included lecture classes and tours of the RCA Camden plant and the RCA Laboratories in Princeton, N. J. The visiting engineers also toured Philadelphia's three RCA-equipped television stations, WFIL-TV, WPTZ, and WCAU-TV.

FIG. 2. While on tour of RCA manufacturing facilities, broadcasters got a closeup view of a Superturnstile television antenna being tested before shipment.





FIG. 3. In Building 53, where most of the RCA's AM, FM, and TV transmitters are assembled, the visitors participated in the tuning and operation of a 5 KW TT-5A television transmitter set up under typical operation conditions.



FIG. 4. In another part of the TV transmitter room, the broadcasters got an opportunity to operate the RCA TT-500A, a 500 watt television transmitter which can be used as a standby unit.

FIG. 5. Intent on learning all they could during the training course, the group below registered this serious pose while they were listening to a talk on the theory and operation of microwave relay equipment used for remote pickups.



Those who attended the sixth training clinic included the following: F. Crandon, WCSH, Portland, Me.; L. E. Littlejohn, WFIL, Philadelphia; F. J. Kern, WFIL, Philadelphia; N. R. Olding, CBC, Montreal; M. L. Poole, CBC, Montreal; W. J. Carter, CKLN, Windsor, Ont.; James Carlisle, CBC, Montreal; W. H. Fattig, WCON, Atlanta; R. L. Newton, WCON, Atlanta; J. W. Keller, Jr., WKOK, Sunbury; J. B. Hershman, Valparaiso Tech. Inst., Valparaiso; J. W. Alinsky, Valparaiso Tech. Inst., Valparaiso; Robert Schroder, WBNS, Columbus, O.; J. V. Sanderson, WSGN, Birmingham; George Cuthbert, Famous Players Canadian Corp., Toronto; G. E. McCurdy, McCurdy Radio Inc., Toronto; T. A. M. Craven, Craven, Holmes & Culver, Washington; J. L. Bateman, Famous Players, Toronto; C. Eastwood, CFRB, Toronto; E. L. Markman, Western Conn. B/C Co., Stamford; E. L. Cordes, WTMJ, Milwaukee; Chester Beachill, CFRA, Ottawa; Jack Siegel, WLOW, Norfolk; Edwin S. Busby, WTAR, Norfolk; C. F. Halle, WXEL, Cleveland; William George, WXEL, Cleveland; N. L. Straub, WJAC, Johnstown; Obert Erwin, WJAC, Johnstown; R. E. Cannon, Jr., WINX, Washington; A. Bates, KFAB, Omaha; Vinton Wight, KFAB, Omaha; H. E. Wehrman, KLZ, Denver; C. Harris, WIP, Philadelphia; L. E. Kilpatrick, WSAZ, Huntington, W. Va.; Willard Hines, WKY, Oklahoma City; W. A. Smith, WROK, Rockford, Ill.; G. E. Ryan, WBBC, Flint; H. J. Nafzger, WBNS, Columbus, O.; William Orr, WELD, Columbus, O.; L. H. Nafzger, WBNS, Columbus, O.; Francis Jacob, WWL, New Orleans; D. F. Hynes, WWL, New Orleans; J. D. Bloom, WWL, New Orleans; R. J. Sinnett, WHBF, Rock Island; J. T. Hetland, WDAY, Fargo; C. F. Quentin, KRNT, Des Moines; D. G. Sinclair, KVFD, Ft. Dodge; Roger Perry, WPOR, Portland, Me.; Roland Hale, WCOP, Boston; Harold Dorschug, WEEI, Boston; J. M. Burke, WAAM, Baltimore; G. W. Fordham, KFKU, Lawrence, Kansas; A. H. Chismark, WTRY, Troy; H. W. McCrae, CBC, Montreal; L. G. Stevens, WLAV, Grand Rapids; Jack Jiruska, KCRG, Cedar Rapids; J. E. Hill, RCA, Boston; J. W. Hilligas, RCA, Atlanta; H. S. Walker, RCA, Canada; R. B. Lanskaill, RCA, Vancouver, B. C.; W. C. Fisher, RCA, Winnipeg; H. F. Wright, Paul C. Harrison, Jerome L. Grover, H. R. Kellaway, R. C. Abelson, RCA Tube Dept., Harrison, N. J.; R. D. Morrison, RCA, Camden; R. C. Dubois, Jr., RCA, Cleveland; E. S. Clammer, RCA, Camden.



FIG. 6. Program switching, lap-dissolving, fading and other features of the TC-5A Program Directors Console were explained to the broadcasters. This console and the control panel, the engineers were told, can also be used in the TS-20A Remote Switching System which is designed for program or master control monitoring and switching.

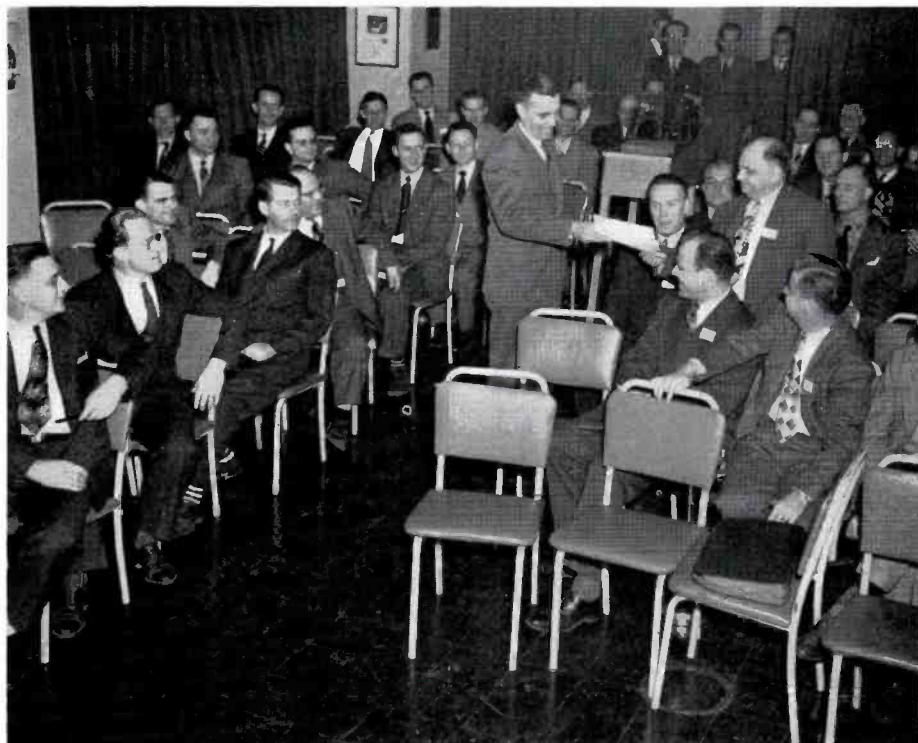

FIG. 7. At the close of the course, D. F. Schmit, Vice President in Charge of Engineering, awarded certificates to the sixty-nine engineers who participated in RCA's sixth television training program.

RCA Broadcast Sales



E. (EDDIE) MILLER
36 West 49th Street
New York 20, New York
Telephone: Circle 6-4030



D. S. (DAVE) NEWBORG
718 Keith Building
Cleveland 15, Ohio
Telephone: Cherry 3450

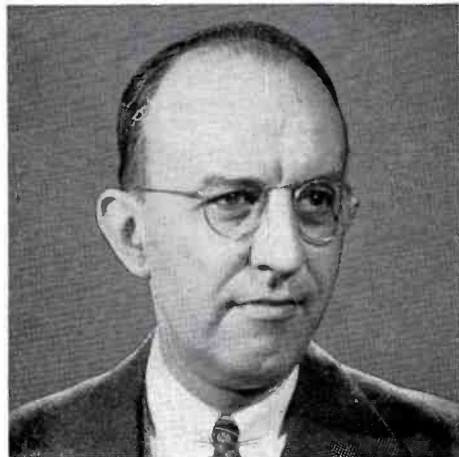

J. W. (JOHN) HILLEGAS
522-33 Forsyth Building
Atlanta 3, Georgia
Telephone: Walnut 5946



Representatives

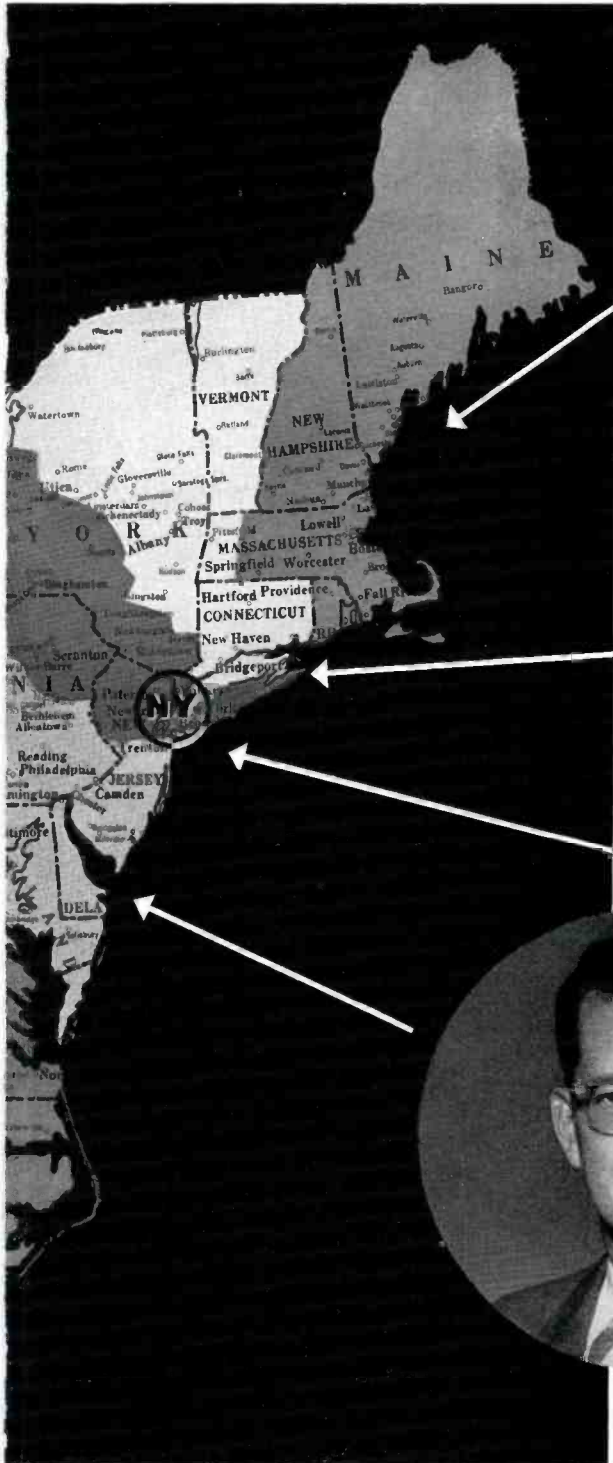

J. E. (ED) HILL, JR.
 36 West 49th Street
 New York 20, New York
 Telephone: Circle 6-4030



J. L. (NICK) NICKELS
 36 West 49th Street
 New York 20, New York
 Telephone: Circle 6-4030



L. W. (LEN) HAEELER
 Front and Cooper Streets
 Camden, New Jersey
 Telephone: Camden 4-8000



A. (AL) JOSEPHSEN
 36 West 49th Street
 New York 20, New York
 Telephone: Circle 6-4030

RCA Broadcast Sales

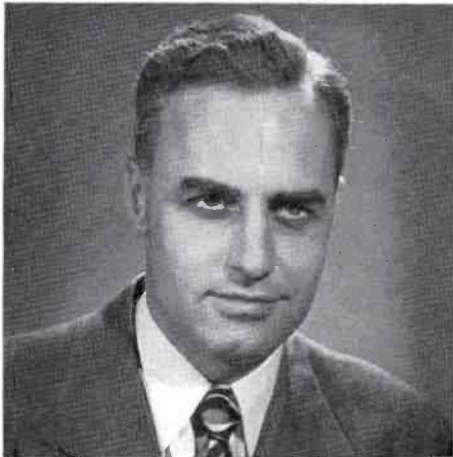

E. C. (ED) TRACY
 666 North Lake Shore Drive
 Chicago 11, Illinois
 Telephone: Delaware 7-0700



F. D. (DAN) MEADOWS
 666 North Lake Shore Drive
 Chicago 11, Illinois
 Telephone: Delaware 7-0700



M. R. (PAG) PAGLEE
 1907-11 McKinney Avenue
 Dallas 1, Texas
 Telephone: Riverside 1371-2-3

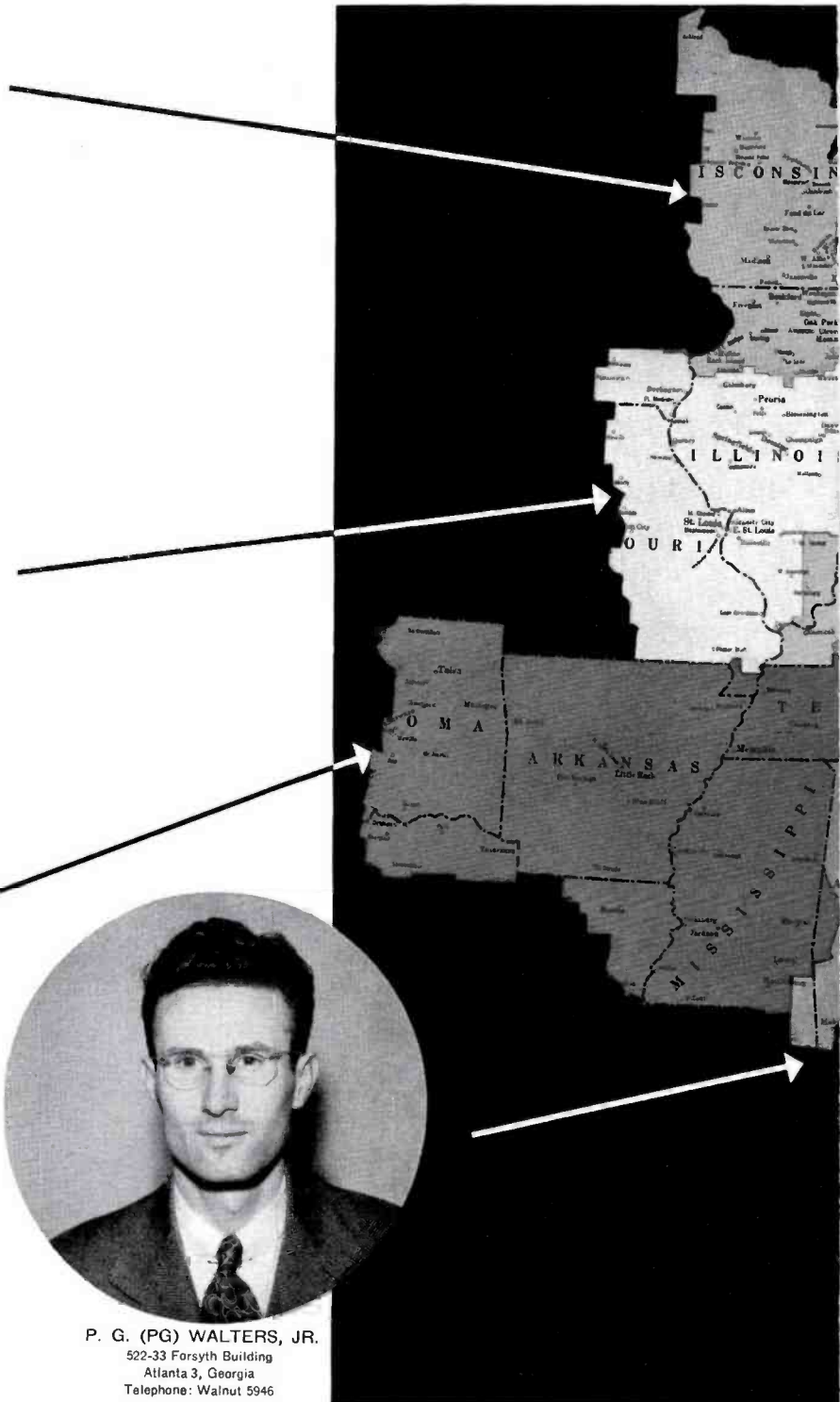

P. G. (PG) WALTERS, JR.
 522-33 Forsyth Building
 Atlanta 3, Georgia
 Telephone: Walnut 5946

Representatives



J. H. (JIM) KEACHIE
718 Keith Building
Cleveland 15, Ohio
Telephone: Cherry 3450



R. C. C. (RUSS) DUBOIS, JR.
718 Keith Building
Cleveland 15, Ohio
Telephone: Cherry 3450



R. J. (PUT) PALMISANO
522-33 Forsyth Building
Atlanta 3, Georgia
Telephone: Walnut 5946

RCA Broadcast Sales



J. P. (JOHN) RILEY, JR.
 Harper-Meggee Building, Republican and Terry, North
 Seattle, Washington
 Telephone: Seneca 5100



R. J. (DICK) NEWMAN
 1355 Market Street
 San Francisco 3, California
 Telephone: Hemlock 1-8300



E. (JACK) FROST
 1560 North Vine Street
 Hollywood 28, California
 Telephone: Hollywood 2154

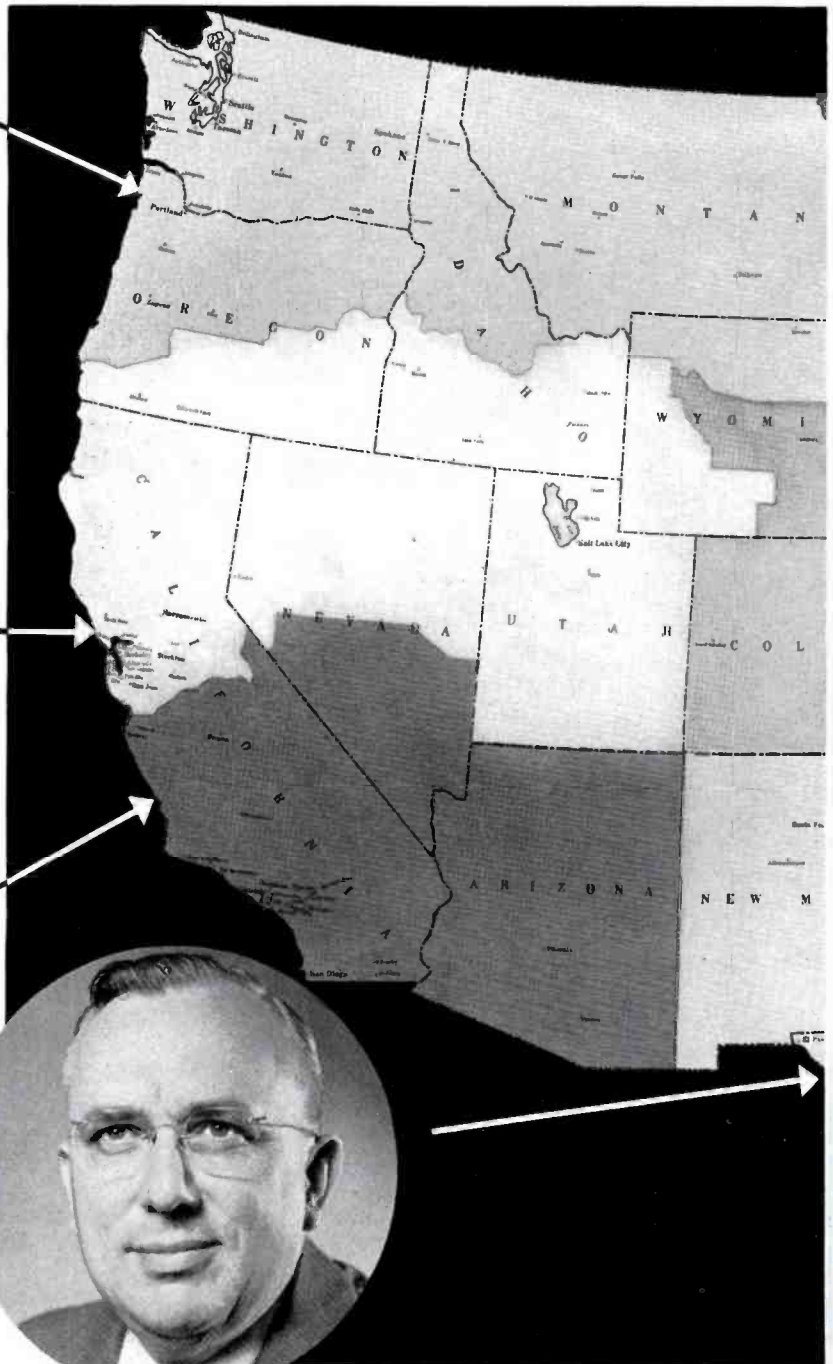

J. F. (JOHN) PALMQUIST
 1907-11 McKinney Avenue
 Dallas 1, Texas
 Telephone: Riverside 1371-2-3

Representatives

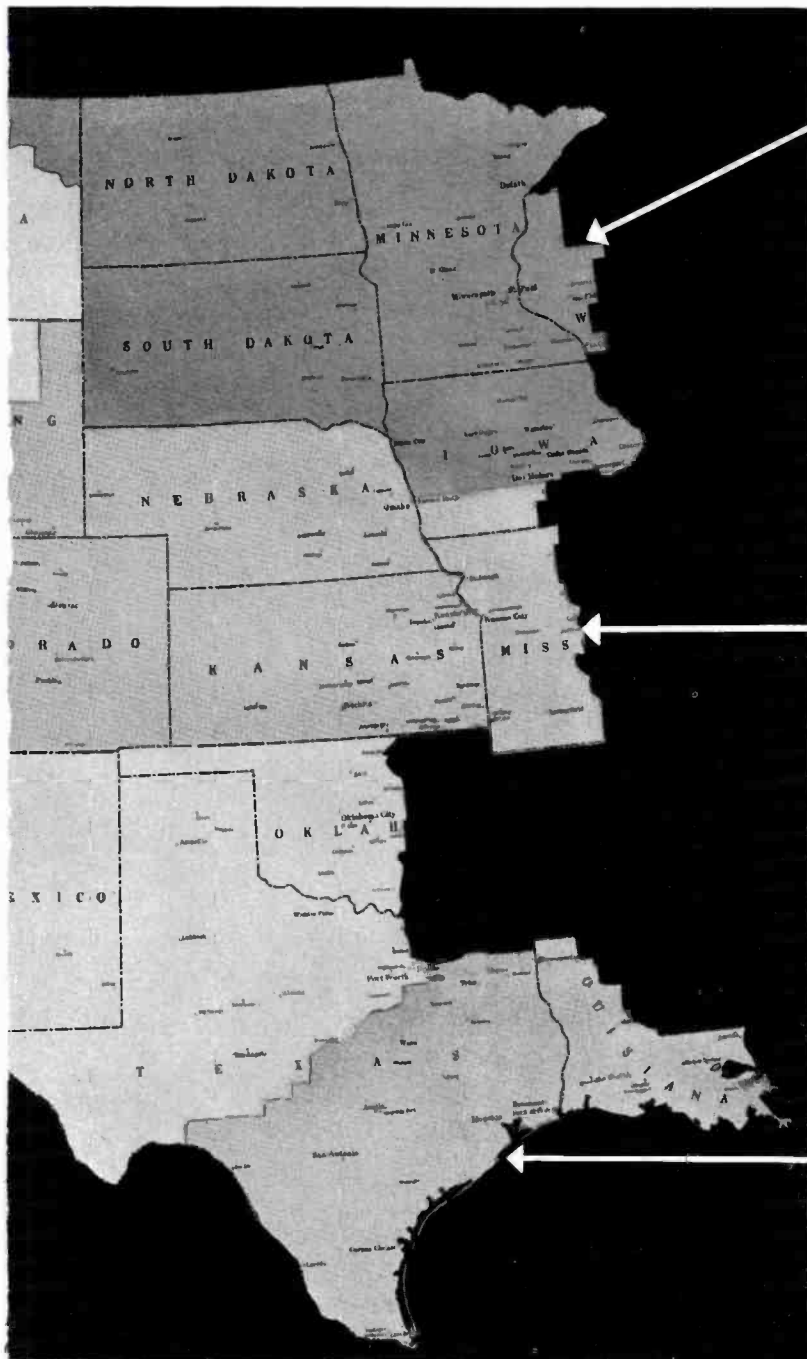

P. H. (PAUL) CLARK
 666 North Lake Shore Drive
 Chicago 11, Illinois
 Telephone: Delaware 7-0700



W. B. (WALT) VARNUM
 221 West 18th Street
 Kansas City 8, Missouri
 Telephone: Victor 6410



F. J. (JOE) KELLEY
 1907-11 McKinney Avenue
 Dallas 1, Texas
 Telephone: Riverside 1371-2-3

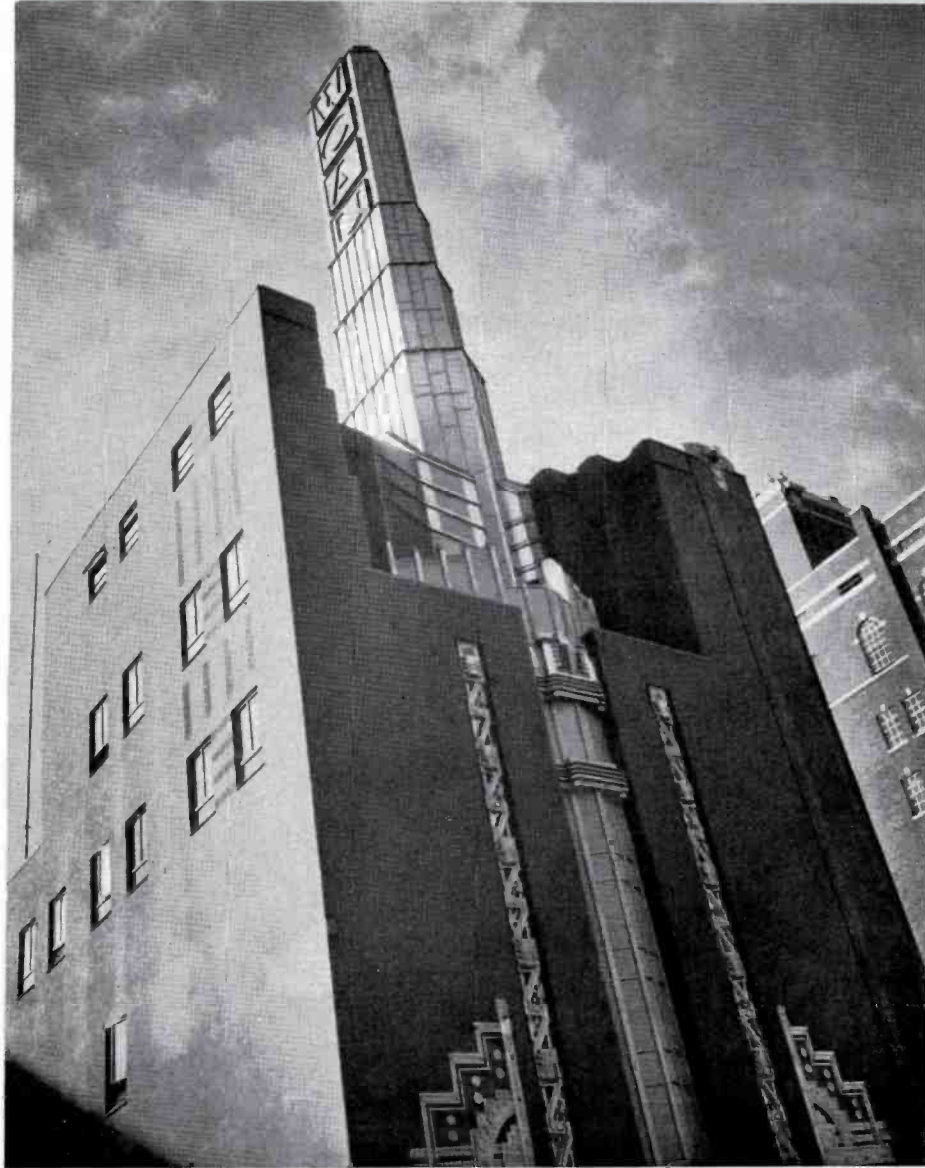

by **JOHN G. LEITCH**

Technical Director

WCAU, WCAU-FM, WCAU-TV

Unlike Cassandra, WCAU-TV has enjoyed the satisfaction of living to see its prophecies believed and its expectations realized. Back in 1931, when the WCAU Building was still in the construction stage, we realized that the station some day would be faced with the task of installing a television station. Accordingly, we planned the building, presumably designed for radio alone, for adaptability to television. Thus, it can in truth be said that WCAU-TV has been 17 years in the making.

WCAU-TV began operations formally on May 23, 1948. In less than ten months we have stepped up our program structure to a point where we are now programming an average of 57 hours each week, exclusive of our unique news, time, weather and music test pattern. Over 16 hours of this time are local, live, originations, and some 9 hours are local film originations. During the 6:45 to 7:00 PM period, we present three complete programs—sports, news and weather—from the same studio. While each program employs three cameras and an entirely different type of presentation, we need only a few feet of space for the three different sets used. This is the result of careful planning and close cooperation between the technical and production departments at WCAU-TV. Recognition of each other's problems patterned the entire building program at the station.

WCAU-TV is owned and operated by WCAU Incorporated, a subsidiary corporation of the Bulletin Company, publishers of Philadelphia's Evening and Sunday Bulletin. WCAU Incorporated also operates radio stations WCAU and WCAU-FM and the facsimile service WCAU-FAX. The TV station operates on Channel 10, 192-198 megacycles, using an aural power of 14.076 KW and a visual power of 25 KW. Our construction permit was granted by



FIG. 1 (left above). The ten-story WCAU Building in down Philadelphia houses all of the studio and office facilities of WCAU, WCAU-FM and WCAU-TV.

FIG. 2 (left). WCAU's unique "news, time and music" test pattern is produced by a flying spot scanner; adaptations for time and news by WCAU staff.

WCAU-TV

the FCC on September 30, 1946, and preliminary work was started immediately. The initial permit was issued to the William Penn Broadcasting Company, then owned by the Evening Bulletin. This was transferred to the Philadelphia Record Company on December 18, 1947 when the Evening Bulletin took control of that Company. The corporate name of the permit holder, Philadelphia Record Company, was changed to WCAU Incorporated on January 16, 1948.

Full scale construction of the studios and control rooms and installation of the transmitter and antenna system started on December 16, 1948. The first test pattern was aired on March 1, 1948, but we waited almost 90 days until May 23, 1948 before launching regular television service. This gave our production and technical crews a chance to run "shakedown" programs and an opportunity to weld into a team. Many programs, of course, including the first symphonic musical program televised—The Philadelphia Orchestra—were originated during this period, but we consider May 23, 1948 as our formal starting date.

WCAU-TV, like its radio counter-part, WCAU, was the first affiliate of the Columbia Broadcasting System's television network. In 1927 WCAU became the first radio station to join CBS. Since our formal opening we have fed many TV programs to the CBS network, and at this time take an average of 30 hours of programs each week from CBS.

Dr. Leon Levy, President and General Manager of WCAU Incorporated, oversees WCAU-TV as well as the AM and FM radio stations. His 25 years of experience in the broadcasting field have stood us in good stead on innumerable occasions, and much of the credit for the finished installations should go to him. Dr. Levy is assisted in the administration of the WCAU Stations by Joseph L. Tinney, Vice President and Assistant General Manager of WCAU Incorporated. Director of Television and Vice President of WCAU Incorporated is G. Bennett Larson.

Mr. George Lewis, Assistant Technical Director, worked directly with the planning and construction of the TV installation. Studio construction went forward rapidly under his direction, with the able assistance of Ray Stahl, Sam Green, Robert Matthiessen, Ralph Rodio, Frank

Catanzaro and other members of the studio group. Ray Craig, Engineer-in-charge of the PSFS plant, installed the TV transmitter and associated equipment with the assistance of Henry Byam, Clement Nace, John Bolmarcich, Al Gengenbach, and others in the transmitter group. Dave Gulette, Operations engineer, kept our AM-FM facilities running smoothly while others concentrated on TV. Lawrence Wilkinson, TV engineer now at WOIC Washington, was actively engaged in construction both at the transmitter and at the studios. Robin Compton, engineer, now at WOIC also, was in charge of TV for the Bulletin and was responsible for the early activities under the C.P. issued to WPEN-TV, later taken over by WCAU-TV. Operating crews were trained by Supervisor Charles Robinson while installation was in progress. WCAU-TV came into being, from a technical standpoint, through the work of these men and the cooperation of all members of the Engineering Department. Architects on the project were McAllister & Braik, Bulletin Building, Philadelphia.

When we decided that the WCAU Building would house our television station, as well as our other stations, we were secure in the knowledge that the building's downtown location at 1622 Chestnut Street, one of Philadelphia's main arteries, would facilitate our overall operation. Philadelphia, while a sprawling city, is a tight little hamlet. All its theatres, major hotels, advertising agencies, department stores, night clubs, etc., are concentrated within an eight block radius of the WCAU Building. Thus the station and its studios are within a five minute walk of the source of the majority of its program matter and business details. Most important, though, is that the ten story structure houses nothing but radio—it was, as I mentioned earlier, designed solely for this purpose. Existing areas, therefore, were ready for conversion to television studios.

It was decided to modify the existing AM Studios for TV for the following reasons:

1. The modifications would be far simpler than the construction of new studios.
2. It would enable us to start operations much more quickly.
3. It would enable us to use existing facilities and services such as air condition-



JOHN G. LEITCH, Technical Director of WCAU Incorporated, in charge of construction and engineering operations of WCAU, WCAU-FM and WCAU-TV; joined WCAU in 1929—since then has engineered AM 50 KW plants and studios, high frequency and FM installations and recently completed studio and transmitter installations for television; former inspector for Radiomarine Corporation and Federal Radio Commission; Commander in Navy during World War II; served as officer-in-charge of Arctic Naval Station, member of attack forces for Gilberts, Marshalls and Marianas and on staff of Comander-in-Chief Pacific and Chief of Naval Operations; member of Veteran Wireless Operators' Association and senior member of I. R. E.

- ing, power, lighting, and audio facilities with modifications for television.
4. It would enable us to use engineering personnel for planning and construction interchangeably with those engaged in other operations.
 5. It would enable us to take advantage of existing traffic, program and building facilities to the extent that they could be used for both AM and TV.
 6. It would give us experience in TV construction and operation to guide us in planning for expanded facilities on a larger scale.

Our experience in modifying existing studios and other spaces for television has shown that this is not an impracticable procedure. I believe the advantage of having basic facilities available and the advantage of a combined operation under one roof more than offsets the difficulties of modification.

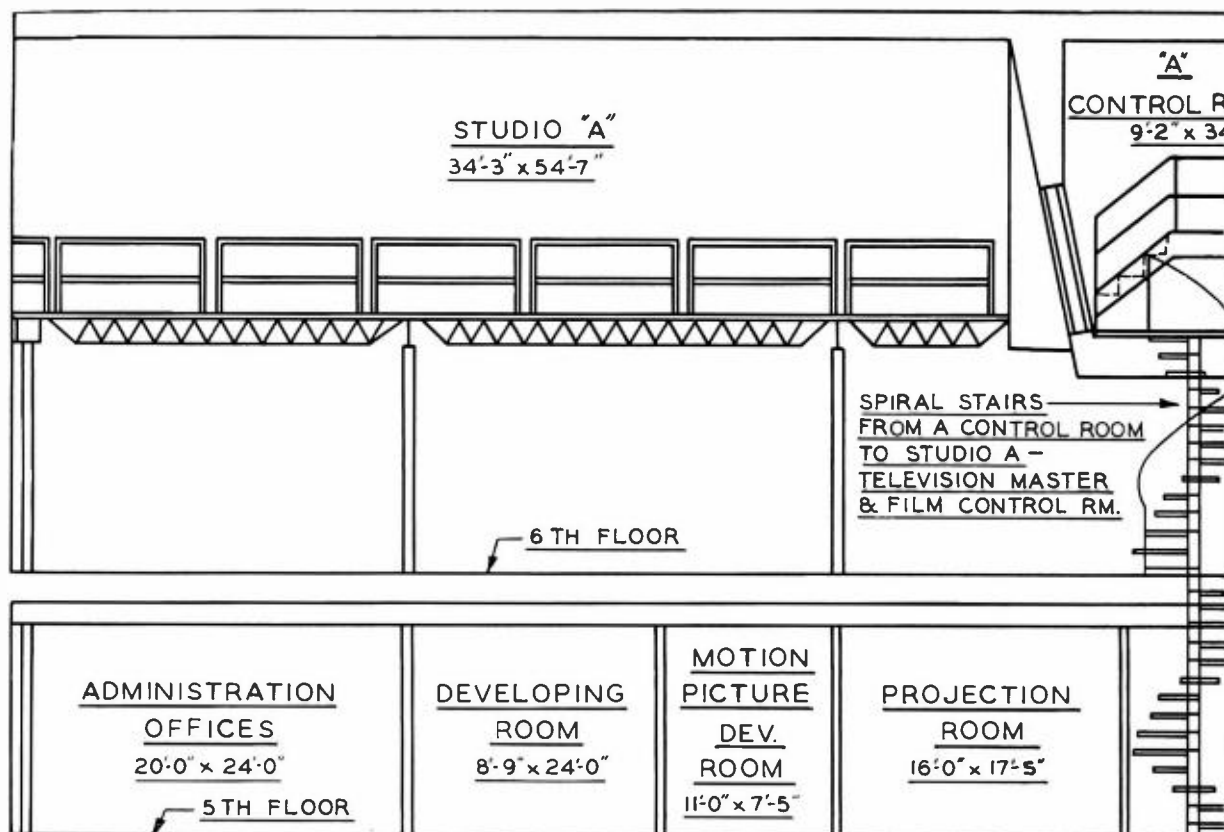

GENERAL ARRANGEMENT OF WCAU-TV BUILDING

There isn't much question about the fact that the ideal television layout is lateral. Were any of us given a choice, the majority of us would select studios and offices that could be contained in their entirety on the ground floor. But this necessitates covering sprawling acreage. And sprawling acreage just isn't available in downtown metropolitan sections. The WCAU Building, like nearly every other such structure, is vertical. And it was up to our designers and engineers to give us as much lateral operation as possible within these vertical limitations.

This we did by converting our two largest radio studios on the sixth floor of the building and using the fifth floor area directly below. Each of these studios is two stories high, with visitors galleries on the seventh floor looking down into them. Studio "A" is 34 x 55 x 22 feet, and Studio "B" is 29 x 36 x 22 feet. The control rooms for each studio were elevated 10 feet above the floor, suspended from the ceiling of the seventh floor. (Fig. 3.)

We believe that the individual control rooms containing camera control equip-

ment, monitors, and audio equipment should be elevated in order that the producer will have an unobstructed view of the studio and in order that the studio floor space may not be restricted (Fig. 4). Therefore, they were installed with the control room floor approximately 10 feet above the studio floor. This permits cameras to be operated beneath the control room if required and also provides storage space for equipment and sets not in use. The producer is in contact with the studio by talk-back, he may step out on the lighting bridge and talk directly with those in the studio, or he may go quickly to the studio by means of the circular stairs connecting the master control room, studios, and the individual control rooms.

While our "A" and "B" Studios are adjoining, we built a storage room between them. This room, which can be reached easily from either studio, serves as a feeder for both studios. Camera equipment, light, props and other items needed quickly can be placed in the joint-feeder room and serve both studios without the interruption of either. Both studios have double

doors at the rear, a necessity in television. A studio can't have wide enough entrances. The double doors of the studio's entrance face each other, allowing us to roll equipment quickly from one location to the other. The entire arrangement affords us a small entranceway between the double doors leading to the studios and the double doors leading to the storage rooms.

In the rear end of the fifth floor (see floor plan, Fig. 17, Pg. 64) we have installed our master control room, film projection room, film editing, cutting, and developing rooms, dressing rooms and repair and maintenance shops. The front half of the fifth floor is devoted to the WCAU-TV program and administrative office. Therefore, we have a maximum of lateral operation confined roughly to two and a half floors of vertical operation.

A circular staircase (Fig. 13, Pg. 60) running from the master control room on the fifth floor, up through the rear corner of each studio on the sixth floor and into the control room of each studio on what is roughly the sixth and a half floor allows our personnel to move quickly from one point to another by the shortest possible

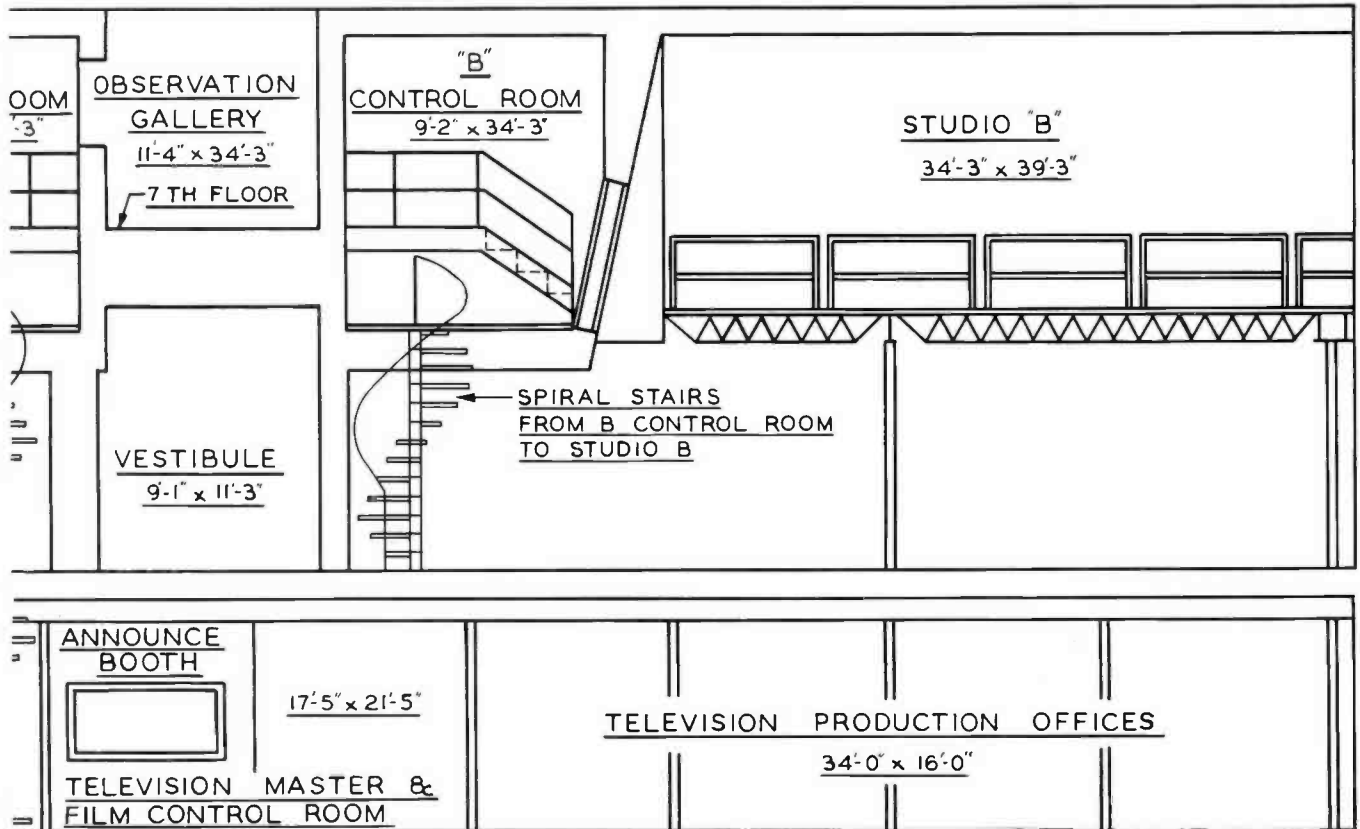

FIG. 3 (above). Elevation view of the 5th, 6th and 7th floors of the WCAU Building. Note spiral staircase providing quick passage between floors.

route, yet without interference to the performers or crews working in the studios.

The overall plan was to gain the compactness of a vertical operation with the conveniences of a lateral plan. And in this we feel we have succeeded. Our maintenance shop, for example, is only across the threshold from master control. Our technicians need but a step to go from master control to the film section. And the same pattern is true throughout the entire installation. Allied functions and facilities have been placed within the closest possible proximity.

Acoustics did not present much of a problem. It is well known that the acoustics in television studios will vary appreciably, because of the changing of scenery and sets from program to program. Our policy, therefore, was to increase the amount of absorbing material, wherever studio walls were opened, to provide for alterations and for the installation of the new TV control rooms. We have not found that acoustics is a problem in the TV operation from these studios. They were adequately soundproofed for AM operation prior to the TV installation.



FIG. 4. View from the control room into Studio A during Horn & Hardart Children's Hour. WCAU-TV control rooms are elevated 10 feet above studio floor.

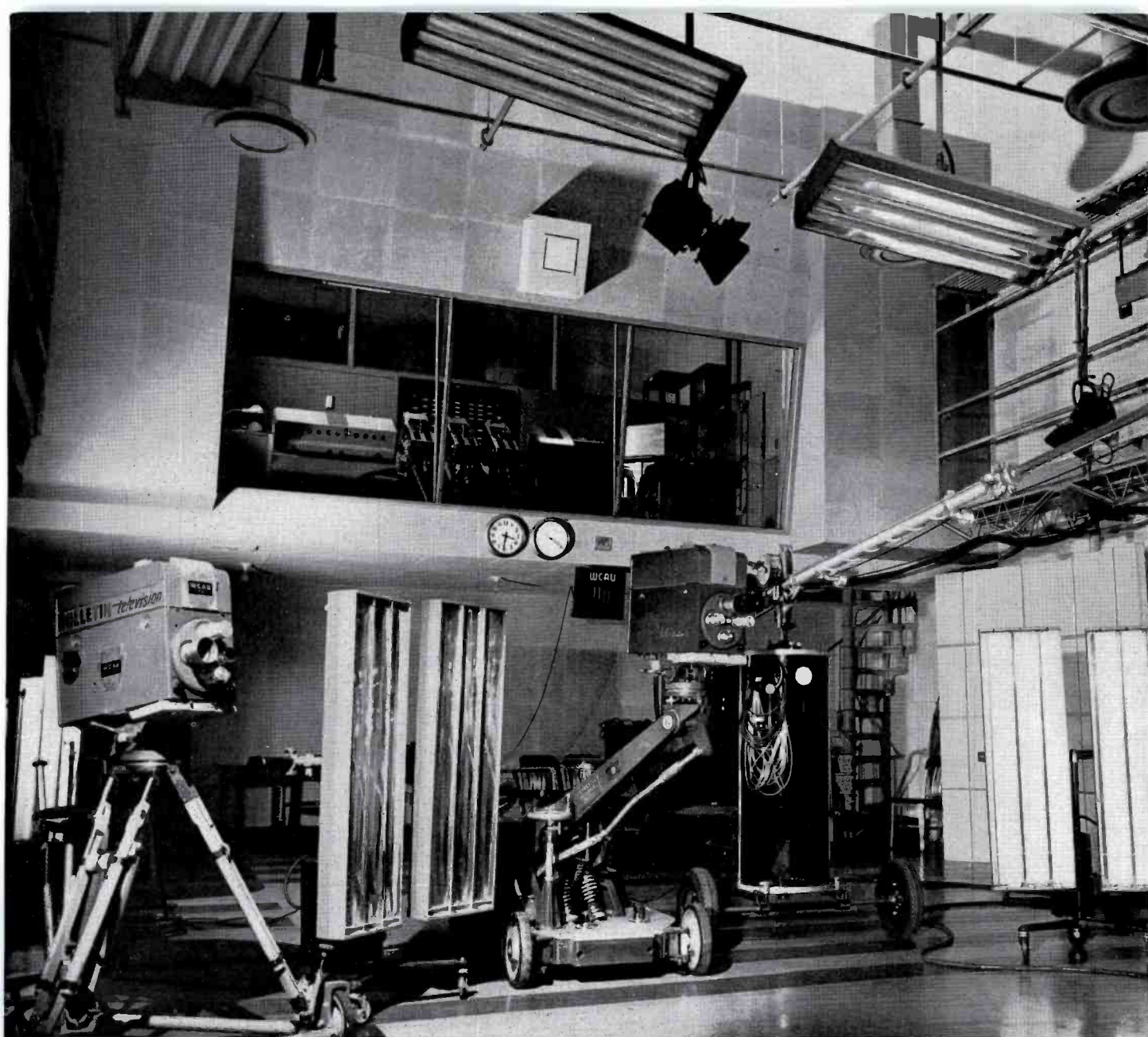

FIG. 5. This view of WCAU-TV's Studio A shows the elevated position of the control room. Space under the control room is available for camera maneuvering or for storage of scenery and props.

WCAU-TV STUDIO "A"

We decided to equip all of the WCAU-TV studios and studio control rooms with field type gear so that remote and studio equipment would be interchangeable. Nine RCA TK-30A camera chains are used among the three TV studios, any of which may be moved to remote pickups as required. A studio type switcher (TS-10A), however, is used in "A" and "B" control rooms. (Fig. 6.)

Placement of equipment is essentially the same in all of the studio control rooms. In "A" (Fig. 7) three camera control units are mounted adjacent to and near the

middle of the large window which separates the studio from the control room. Immediately to the left of the camera control units are located the studio type switcher and master monitor. To the left of the producer a 630 TS receiver serves as an on-the-air monitor. To the right of the camera control units the audio console is mounted on a specially built wooden stand. Two turn-tables are placed to the right of the audio console within easy reach of the audio man.

This arrangement of the video and audio equipment provides the producer, video control and audio operators with a full

view of the studio as well as a view of pictures on the camera controls, master monitor and on-the-air receiver.

A Tele-talk unit is mounted to the producer's left between his master monitor and air monitor with which he can communicate directly with the TV control room, studio "B", studio "X" or projection room. A talk-back microphone is located on the producer's right with which he is able to talk to the studio during rehearsals. The power supplies for the three camera chains are located to the far right underneath the steps leading out of the control room. The power supplies for the switcher and master monitor and the stabilizing amplifier are

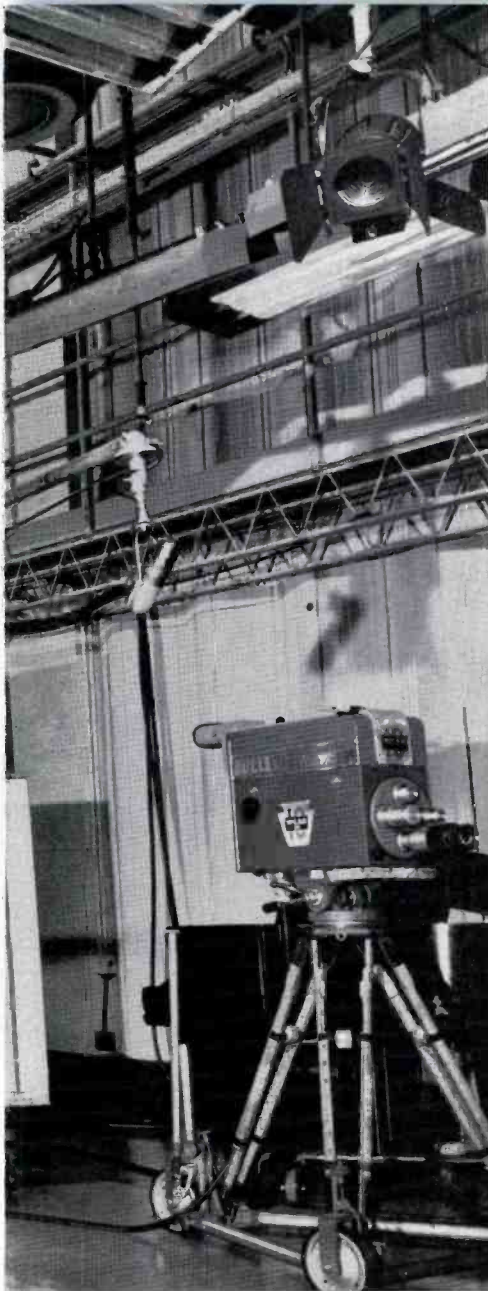

rack-mounted near the left rear corner of the control room.

Wiring ducts covered by aluminum plates run the length of the control room front and back, with a connecting wire duct in the middle and at the right end of the control room for housing of all interconnecting cables and wires. Camera cables are run from the floor of the front left corner of the control room along the lighting bridge to the three cameras. The control panel for studio "A" lighting equipment is located centrally on the rear wall of the control room.

A door on the left of the control room provides access to a steel spiral stairway leading to Studio "A" below, and to the

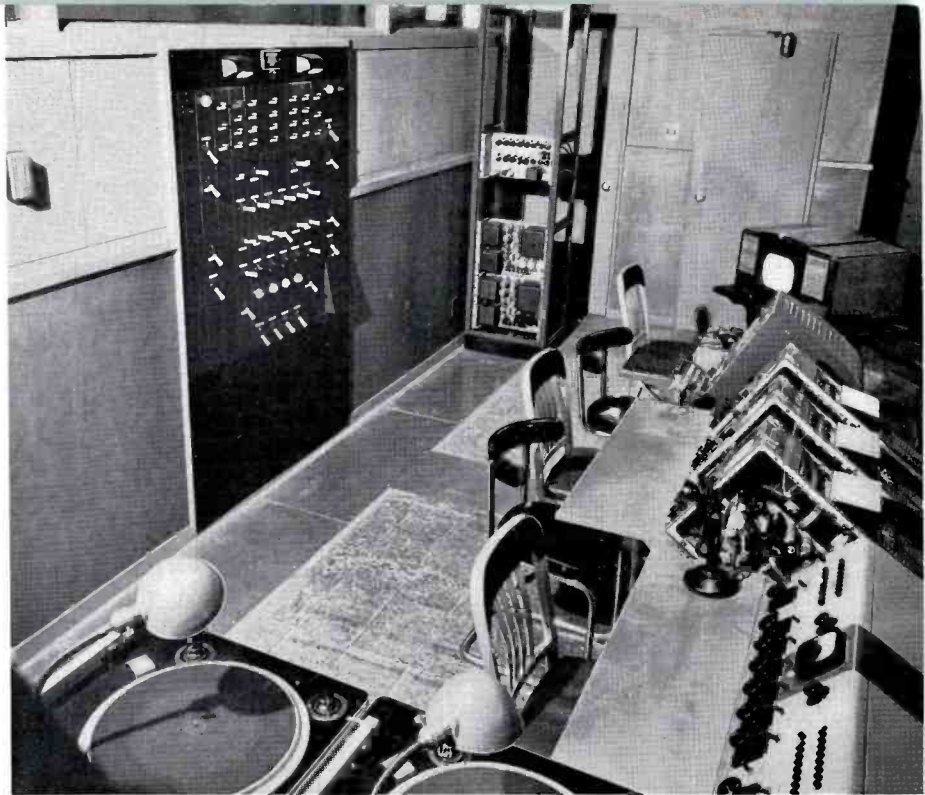

FIG. 6. Control room of Studio A. Turntables and audio console are in the foreground. Video units, just beyond, include three field type camera control units and a studio-type mixer and master monitor unit. Panel on the wall at rear is lighting control center (see description on page 66).

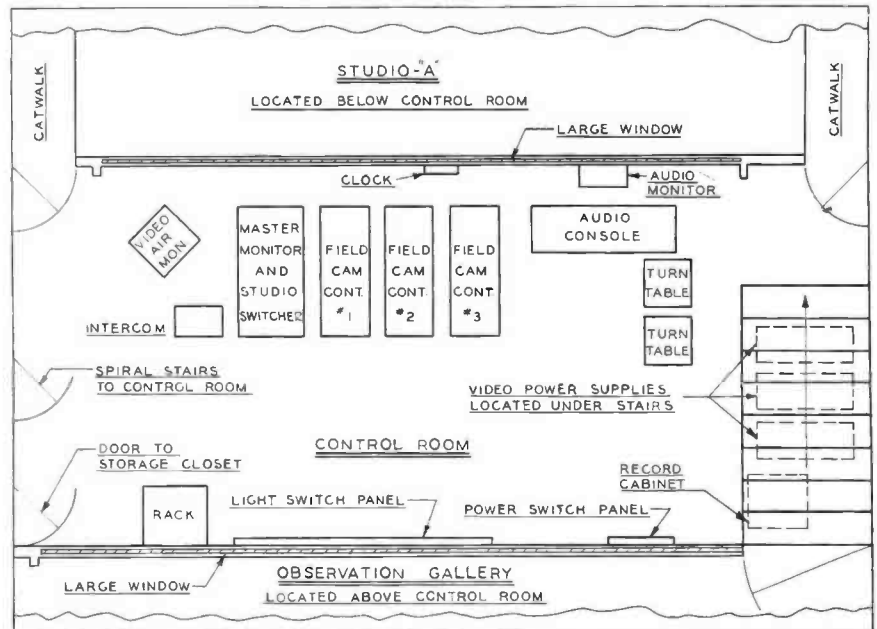

FIG. 7. Floor plan of Control Room A showing location of equipment units. The observation gallery, which is a half floor above the control room, provides a view through the control room into the studio.

TV control room and projection room one floor below Studio "A". On both right and left front corners of the control room there are doors leading to the studio lighting bridge. An equipment locker is situated at the far left rear corner of the control room.

Above the level of the lighting panel board at the rear of the control room a long window separates the control room from the gallery—a space from which spectators are able to see both into the control room and Studio "A".



FIG. 8 (above). View of Studio B from one of the catwalks which extend along the sides of both Studio A and Studio B. Note circular stairway at rear which provides quick access from control room to studio.



FIG. 9 (left). Video control units in Control Room B. General arrangement of equipment is similar to that of Control Room A (see Fig. 7).

WCAU-TV STUDIO "B"

Studio "B" control room is located on the same level as Studio "A" control room and the two control rooms are separated by "A" gallery. The camera control units (Fig. 9) are located near the middle of the control room and adjacent to the large window separating Studio "B" from the control room, as in Studio "A" control. The master monitor is mounted to the left of the camera control units in a Field Carrying Case. All of the camera control units and master monitor are mounted on specially built wooden stands as in "A" control room. At present the TS-10A studio switcher is located to the left and behind

the master monitor. The future plan is to raise the switcher and producer position so that the producer will be able to look down into the studios over the camera control units. To the left of the switcher is located the audio console, and to the left of the audio man's position two turntables are placed within easy reach. To the right of the camera control units an RCA 721TS receiver is mounted and serves as an on-the-air monitor. A Tele-talk unit is mounted on the studio switcher rack and provides communication between that point and TV control room, Studios "A" and "X" and the projection room. A talk-back microphone is located on the producer's right, as in Studio "A" control.

Power supplies for the camera control units are located at the far left side of the control room underneath the steps leading to "A" gallery. The power supplies for the master monitor, studio switcher and the stabilizing amplifier are rack mounted at the right rear of the control room.

Wire ducts in the floor house all cables and wires as in "A" control room. Doors on either side of the control room lead to the studio lighting bridge and a door on the right rear of the control room leads to a spiral stairway into the studio. As in Studio "A" control room, the producer, video and audio men have a full view of the studio as well as the picture monitors.



FIG. 10 (above). WCAU-TV's Studio X, shown above, is a 250-seat auditorium on the second floor of the building, designed originally for audience-type radio shows. It was easily modified for television and has worked out very well. Note cameras which are mounted on four-foot wooden platforms, two on the left of the auditorium and one on the right near the center.

FIG. 11 (right). Studio X Control Room, shown here, was originally a motion picture projection booth at the rear of the auditorium. Equipment is nearly identical to that of other control rooms—standardization being one of the features of the WCAU-TV installation.



WCAU-TV STUDIO "X"

Our auditorium studio (Fig. 10) is located on the second floor of the building. This studio seats 250 people and has been used for our radio productions for some years. It took very little actual construction to equip it for television. Fluorescent and incandescent lights were installed in the ceiling of the stage and a motion picture projection room at the rear of the auditorium was converted into a TV and sound control room. Camera platforms were built at two positions in the audience space and camera equipment installed on stage for close ups. It has proved highly satisfactory and we have found that we can produce

almost any type program from this auditorium studio.

Studio "X" control room (Fig. 11) is situated to the rear of the auditorium and is separated from the auditorium by a large glass window. Here again the audio man, producer and video man have a full view of the auditorium and stage together with a good view of the picture monitors.

Three camera control units, field switcher and master monitor are mounted on a flat table near the center of the large window. To the right of the camera control unit

an RCA 721TS receiver serves as an on-the-air monitor. To the left of the camera control units and master monitor a Teletalk unit provides communication between that point and TV control room, Studios "A" and "B", and the projection room. A talk-back microphone is mounted to the right of the field switcher for talking to the stage during rehearsals. To the left of the video control equipment is the audio console and two turntables.

Power supplies for the camera controls, master monitor and field switcher are located beneath the table.

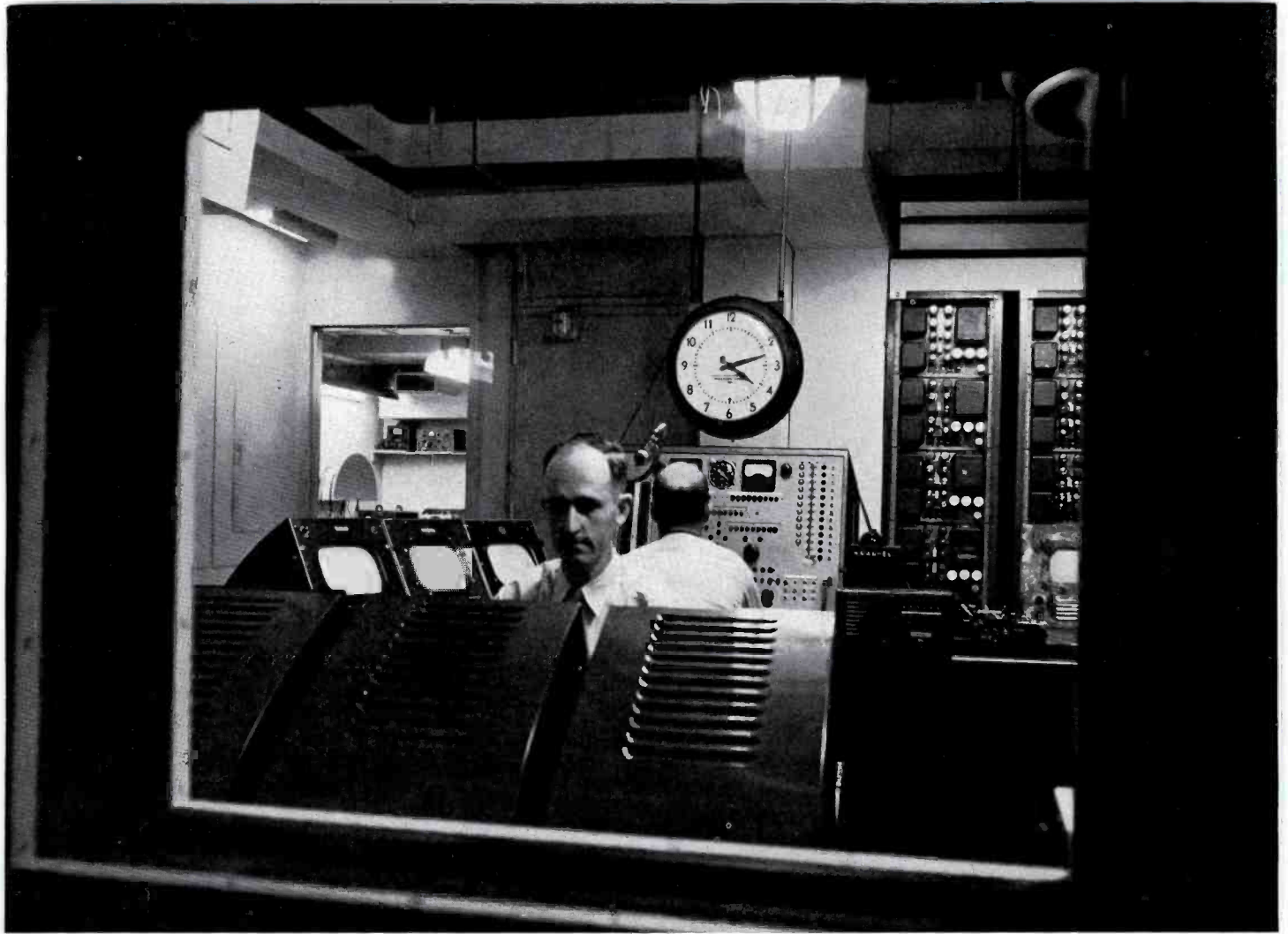

FIG. 12. The WCAU-TV Master Control Room, as seen through the window of the projection room.

FIG. 13. The circular stairway which leads from master control to studios and control rooms.



WCAU-TV MASTER CONTROL ROOM

An efficient master control room is always the key to successful operations. At the time our facilities were designed, there were no independent television stations operating with complete master control facilities; therefore, it was necessary to start from scratch. In analyzing the problem we soon reached the conclusion that although television was a new medium, we still had the fundamental problem of handling programs from a number of sources in an efficient manner. Therefore, with due respect to the video requirements, these facilities were designed along A. M. master control lines. In the WCAU-TV master control room, the following facilities are now available:

1. Facilities for the switching of six video and audio circuits to one or two outgoing channels simultaneously or separately.
2. Facilities for the mixing and fading of these sources on either one of the two channels.
3. Facilities for switching four composite

signals to one or two outgoing channels simultaneously or separately.

4. Facilities for receiving or transmitting Columbia network programs.
5. Facilities for feeding air and channel monitoring to the studios, control rooms, announce booth, projection room, observation galleries, audition room and house monitor system.
6. Facilities for monitoring air, studios, film, slides, remotes and network in master control.
7. Video and audio jack panels for special setups and emergency patching.
8. Facilities for feeding driving, blanking and sync pulses to the studio control, projection and master control equipment.
9. Facilities for feeding video, audio and pulses to the TV shop for test purposes.
10. Facilities for feeding the output of test generators to all locations for maintenance purposes.
11. Facilities for control of film and slide audio and video equipment.

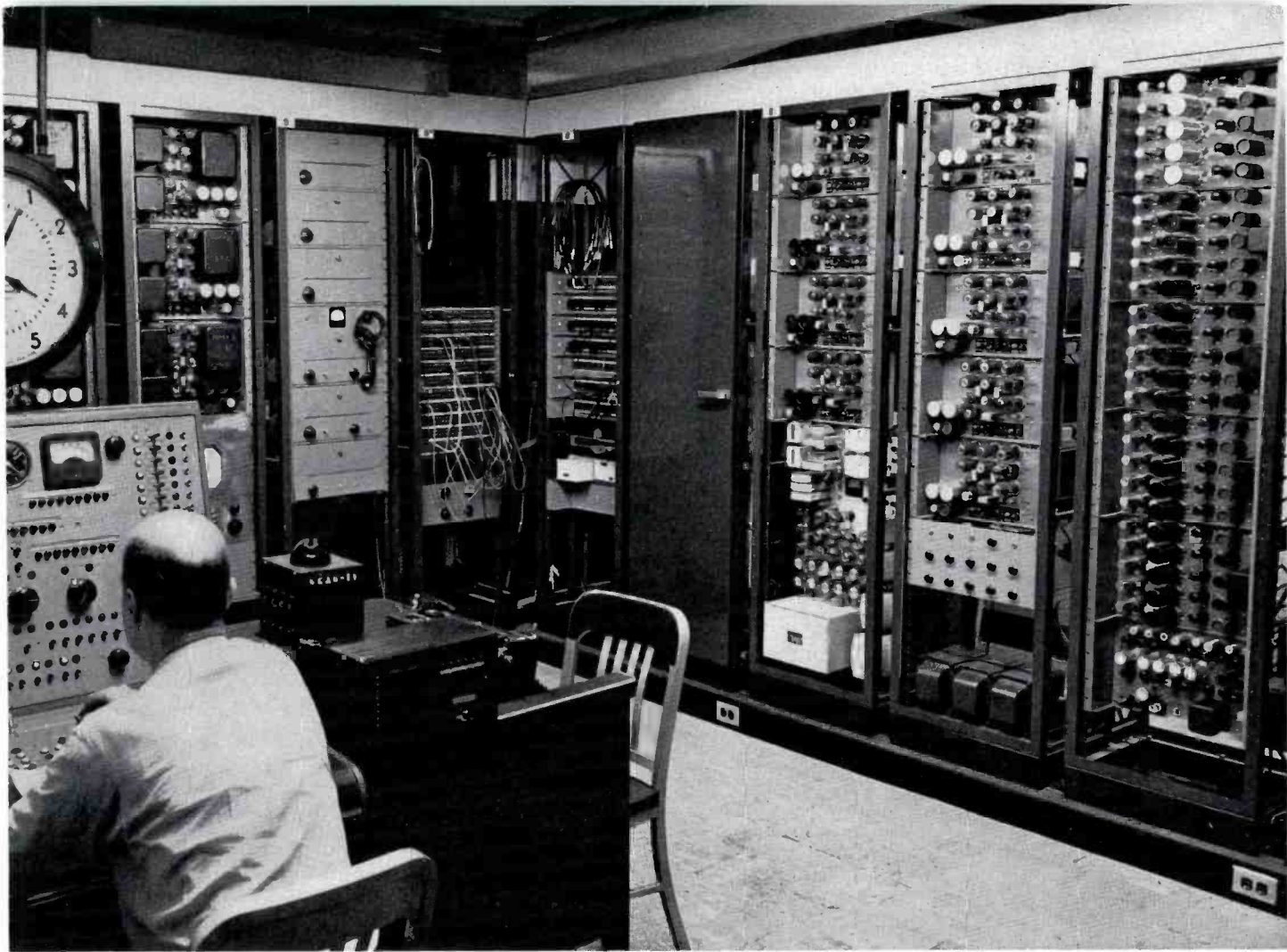

FIG. 14. Two sides of the master control room are lined with racks which contain sync generators, power supplies, distribution amplifiers, audio, monitoring and test equipment.

12. Facilities for control of announce booth and turntables.
13. Intercommunication and telephone facilities to all operating positions.
14. Complete power distribution facilities.

The wiring among all equipment locations is contained in a wire-duct system, which saved considerable time during the installation and is convenient for connecting additional facilities.

Three views of the master control room are shown above, and at the right (Figs. 13, 14, 15). The control units are arranged in the form of a U (see floor plan, Fig. 17, Pg. 64). Facing the projection room windows (Fig. 12) are the two film camera controls. Beside these two controls is the audio control for film, turntables and announce booth. This booth is directly behind the turntables (Fig. 15) and is equipped with video and audio monitoring facilities, microphones, and communication facilities. To the right of the turntables are the video monitors for the control desk operator. In Fig. 14 is another view of the control desk, and also the racks containing

FIG. 15. Another view of master control room. Film camera controls are at left, turntables next, followed by video monitors (line, preview, on-air) and master switching console.



FIG. 16 (right). Simplified block diagram of WCAU-TV's video facilities at the studio location.

power supplies, audio amplifiers, audio and video jacks, video amplifiers, and sync generators.

Because our master and film control, projection room, rewind room, film editing room, film processing rooms, and shop are in close proximity to one another, we are able to obtain close coordination among them. The remainder of our facilities may be shut down during periods of network with film or slide inserts which has proven practical and economical in operation.

WCAU-TV Audio

While the picture in television is of prime importance, it is well to remember that a picture usually is worthless without sound. In equipping WCAU-TV we placed just as much emphasis on our audio as video.

Audio facilities in Studios "A" and "B" use the 76-B4 Consolette as a foundation unit. Six microphone outlets are provided in each studio, and the switching arrangement permits any four microphones and two 70D transcription turntables, which are located in each control room, to be used for a program set-up. 77D microphones, fitted with various types of mountings, including Mole-Richardson and KS-3A booms, are used for their excellent directional characteristics and frequency response. For monitoring, the W. E. 756A speakers are used in an infinite baffle mounting. Both air monitor and channel monitor are available and may be switched at the console.

The projection room is equipped with two TP-16A, 16mm film projectors. Their pre-amp. outputs are switched by the projectionist and fed to TV Master Control for level adjustment and switching to the proper channel. Air monitor and channel monitor are available at all times. An intercom is used for coordination.

The Master Control uses a modified G. E. control desk for audio and video switching, level indication and control. This desk comprises two complete audio and video channels. The audio channel uses two RCA BA3C program amplifiers, and two RCA BA4C monitor amplifier. W. E. 756A speakers are used throughout the TV installation. Two Presto 64A synchronous motor turntables, equipped with RCA Universal pickups, equalizers and booster amplifiers, are used for transcriptions and records. An intercom. system is used between Master Control, projection room, the two studios, and the auditorium for coordination.

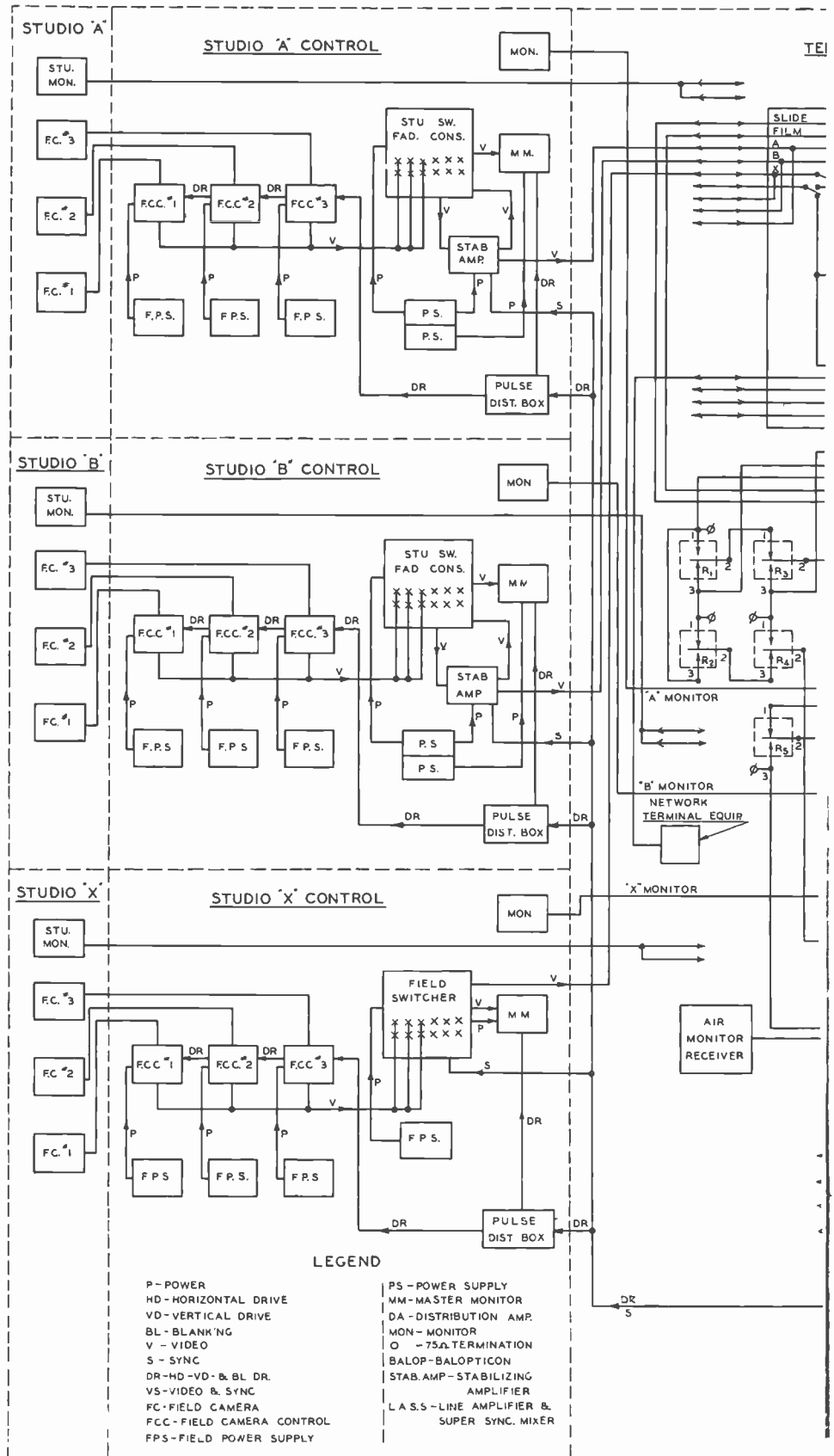

VISION MASTER AND FILM CONTROL ROOM

PROJECTION ROOM

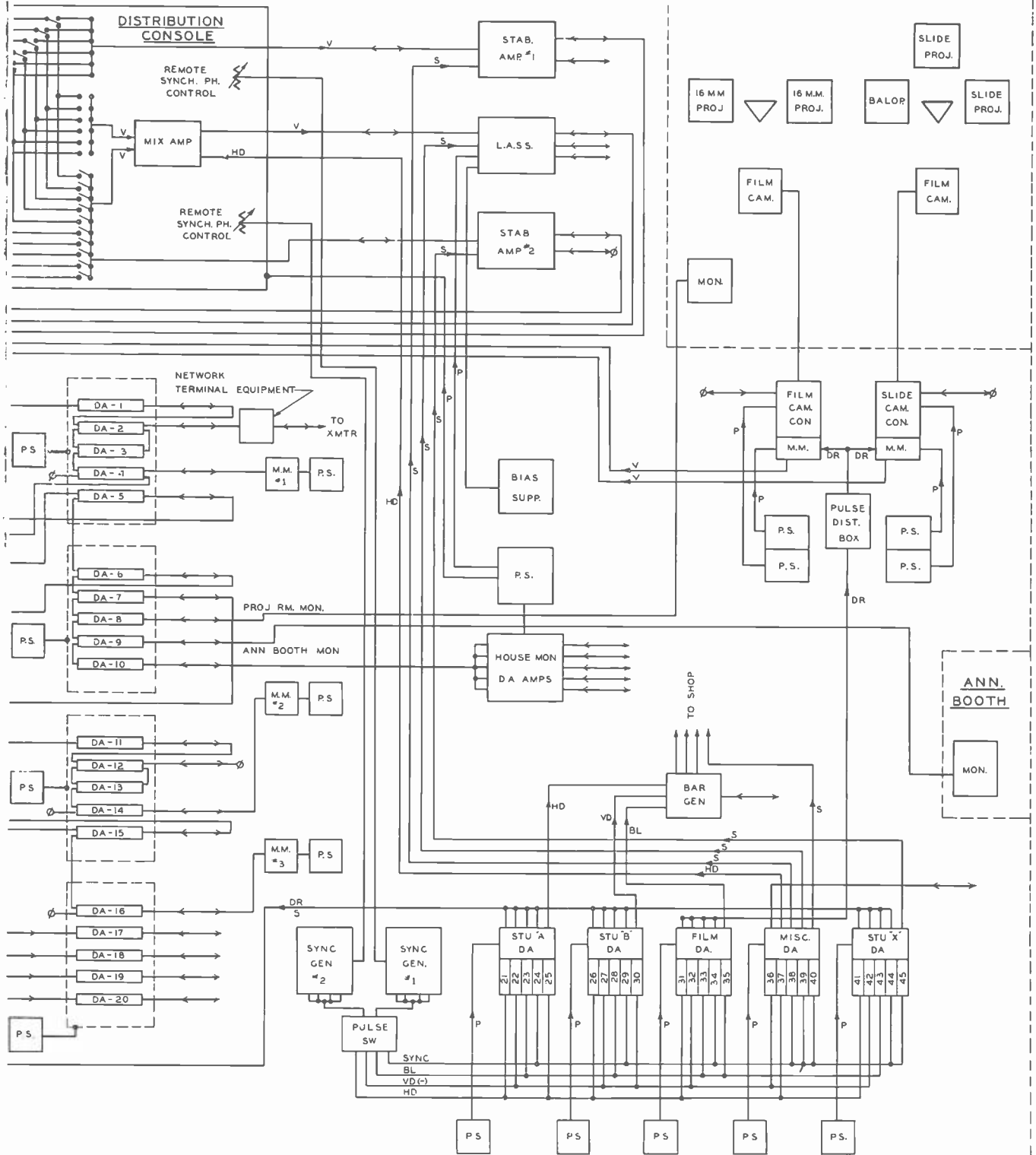

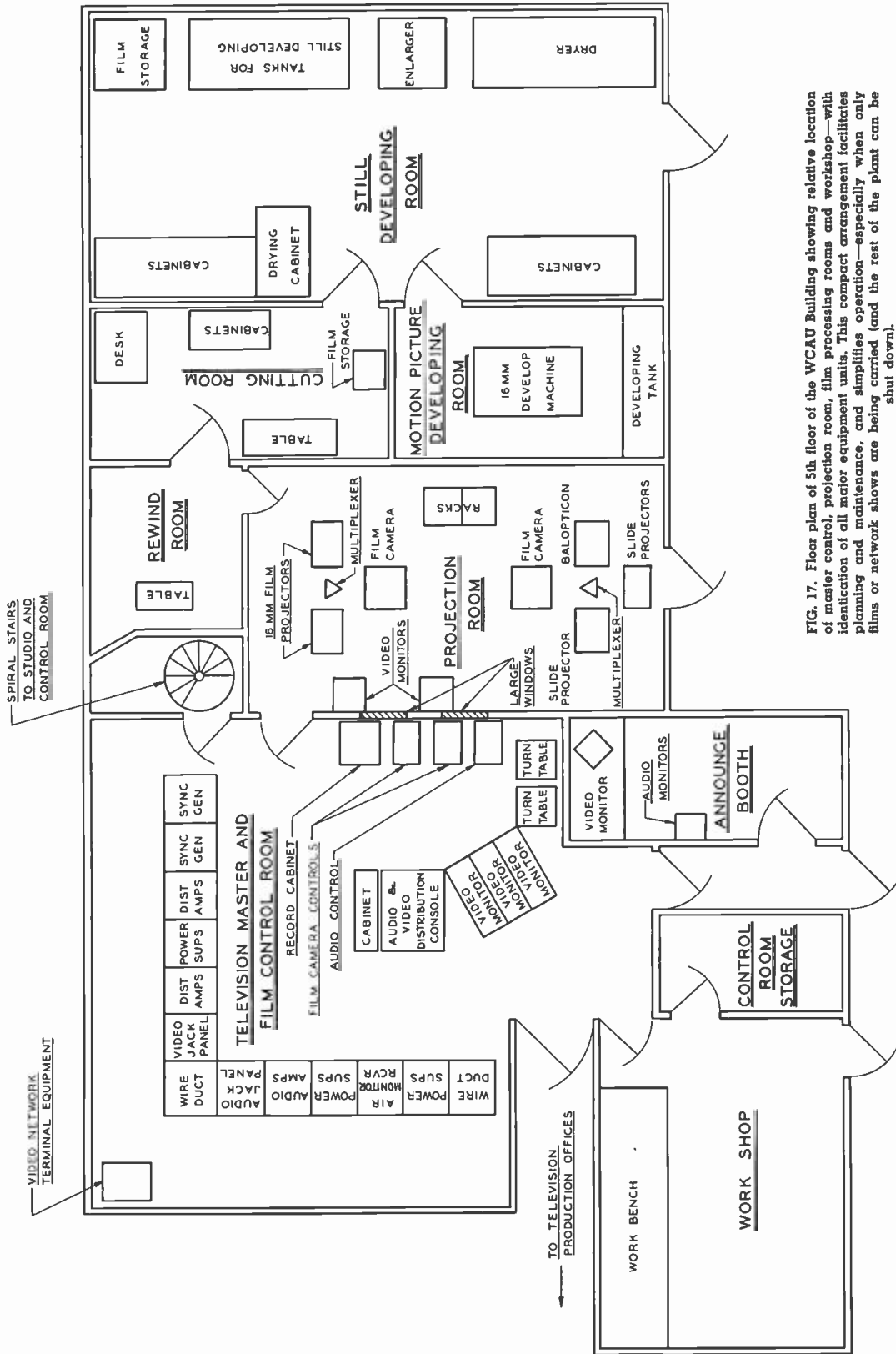

FIG. 17. Floor plan of 5th floor of the WCAU Building showing relative location of master control, projection room, film processing rooms and workshop—with identification of all major equipment units. This compact arrangement facilitates planning and maintenance, and simplifies operation—especially when only films or network shows are being carried (and the rest of the plant can be shut down).

WCAU-TV FILM DEPARTMENT

Our Motion Picture Department is under the direction of Roy Meredith, who has had many years of TV and photographic experience. Fig. 18 is a view of part of the projection room, showing the 16mm projectors, multiplexer, film camera, and overhead monitors. The second film camera for slide transparencies and opaques is mounted to the left of this equipment and is not shown.

Four rooms are used for editing, cutting, rewind and developing and they adjoin the TV projection room. Although we use 16mm film only at the present time, all of these spaces have been set up in accordance with fire regulations for later use of 35mm film.

A Houston Developer with capacity of 400 feet every 45 minutes has been installed for 16mm film. Cypress tank, cabinets for chemicals and fireproof cabinets are available. Developing tanks in the dark room for 'stills' are of stainless steel. Trays, a multi-size enlarging camera with tilt-

FIG. 18 (right). View of the WCAU-TV film projection room. In foreground are two RCA 16mm projectors with multiplexer between. Film camera is just behind the front projector. A second film camera, used for slides and opaques, is not visible in this view.

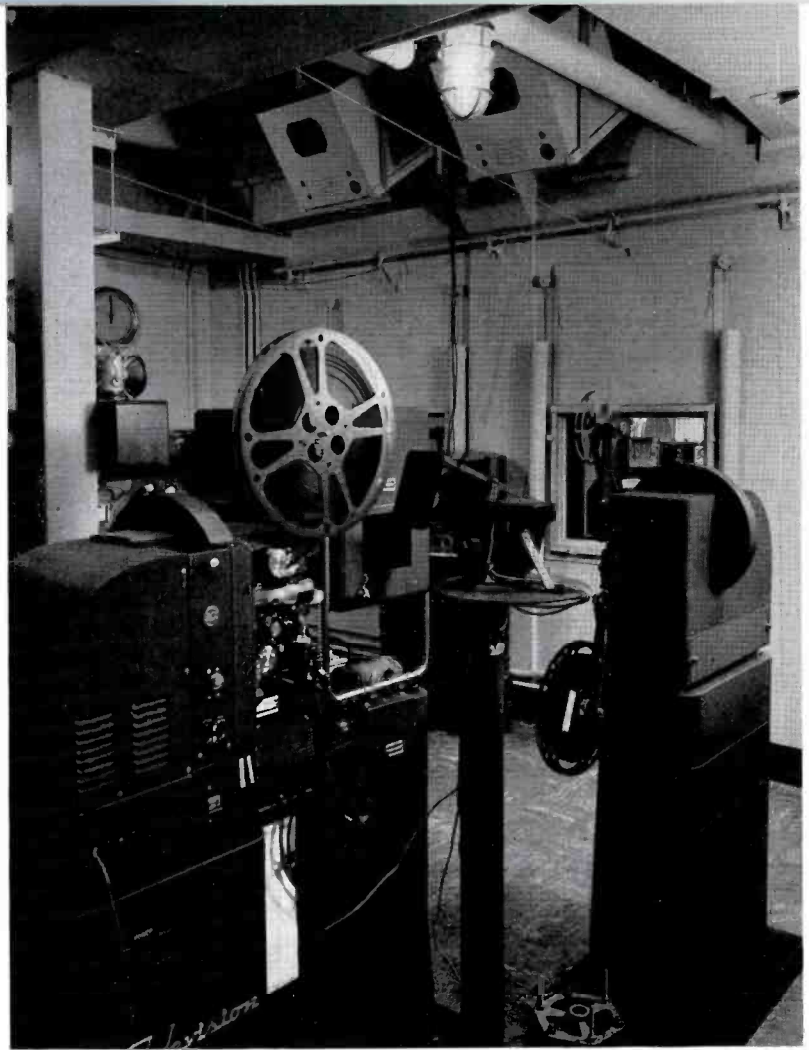

board and fireproof storage facilities complete the equipment in this room. Cutting and editing devices are used in the two smaller rooms—again with storage space for film and for slides.

The camera equipment consists of an Auricon single-system sound camera, an Eastman Kodak silent 16mm camera and a Bell and Howell 70 D.A. Three still cameras are used—a 4 x 5 Speed Graphic, a Leica with Speed-O-Copy for making slides and a 5 x 7 Folmer Graflex.

Our film department is prepared to make slides, 16mm commercial spots with or without sound and all film work incidental to our TV operation. Currently a 15 minute show is being filmed each day at the Bulletin Homemakers Center for telecasting the following day on WCAU-TV.

FIG. 19 (left). A view of the re-wind room. WCAU-TV's film setup includes four rooms—in addition to the projection room proper. Station is equipped to make 16mm silent or sound movies.

WCAU-TV STUDIO LIGHTING

The true secret of good television pictures is light. In radio we spared no effort to get perfect sound. And in television we must get the right kind of lighting.

The first function of a television system is the same as that of any photographic system—reflected light from the scene is focused on a light sensitive plate. Photography changes the chemical properties of the plate. A television system changes the electrical properties of the plate. We can readily see then that the final result obtained on the viewer's screen can be no better than the picture on this light-sensitive plate and that the quality of this picture depends entirely on the quality of the reflected light from the scene being televised. With proper light *quality* and with a sufficient *quantity* of light to activate the light-sensitive plate, we can create an illusion of depth and dramatic and artistic effects. Through the proper use of lights a television station can create desired viewer moods from fear and mystery to cheerfulness and gaiety; all necessary in holding audience interest. With proper lighting arrangements we can display merchandise more effectively and therefore sell more of this merchandise.

Since the cost of constructing and operating any television station is reasonably high, that station, in order to be successful, must be made a highly effective advertising or selling medium. Lighting plays an important role in bringing this about.

Early television stations and in fact most television stations today, use a very high incandescent light level. This results in discomfort for the performers and operating staff and high air conditioning construction and operating costs.

In constructing studios for WCAU-TV, we took advantage of the availability of the more efficient camera tubes and the newly designed cold light fixtures to insure better performance and lower operating costs. Our Assistant Technical Director, George Lewis, made an intensive investigation of lighting sys-

FIG. 22 (below). Lighting control panel located in Control Room.

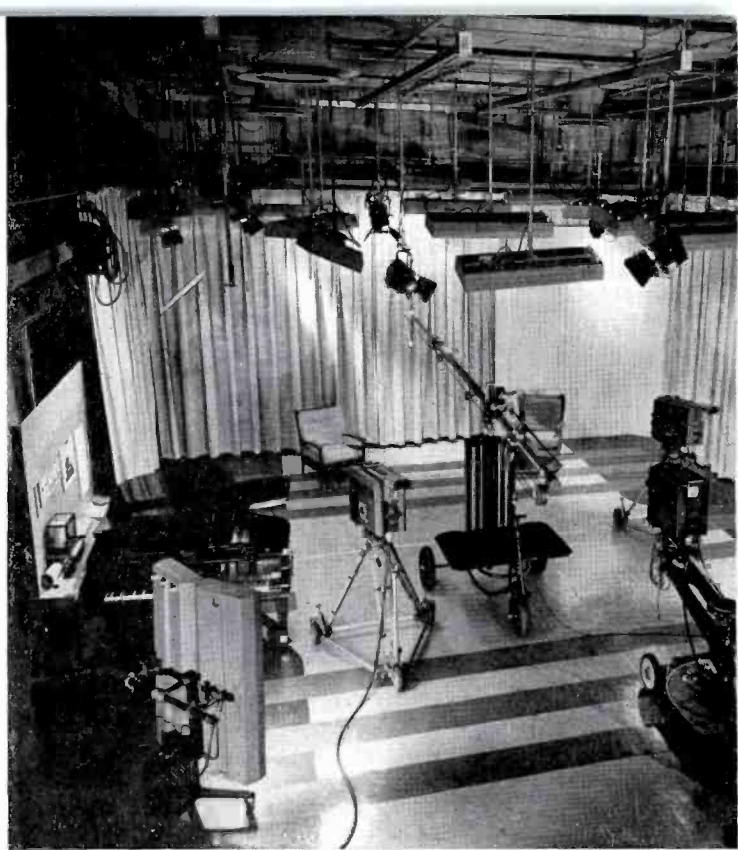
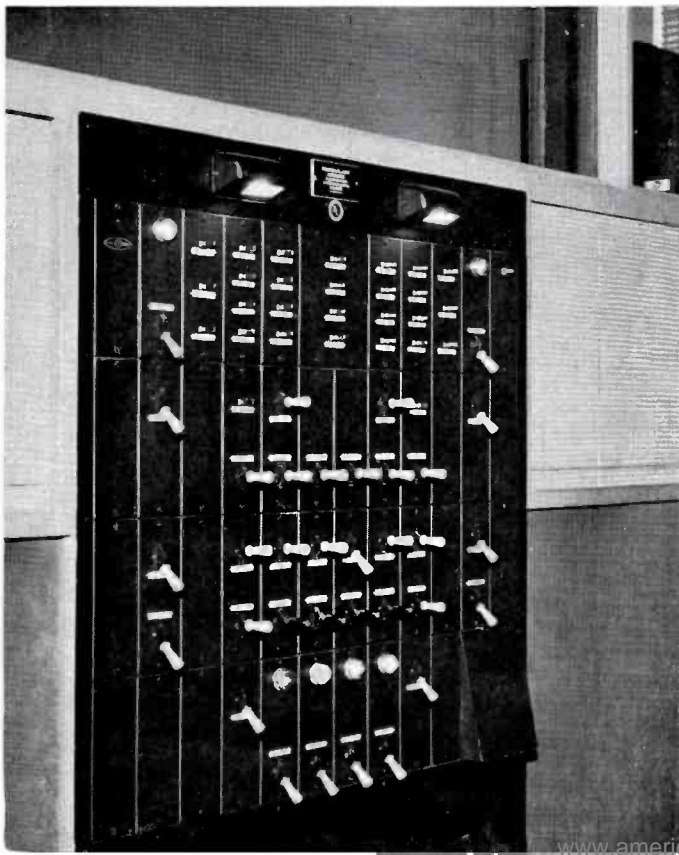

FIG. 20. Front lighting in WCAU-TV studios is supplied by adjustable fluorescent units similar to those mounted overhead.

tems and was in large measure responsible for the lighting we installed. The following were taken into consideration in the design of the lighting system:

- A. Installation and operation costs.
- B. Camera tube characteristics.
- C. Flexibility in handling and controlling.
- D. Physiological effect on performers and operating personnel.
- E. Heat radiation problems.
- F. Maintenance.

In the design of any photographic or TV lighting system, facilities should be available for:

- A. General over-all or foundation lighting.
- B. Front lighting.
- C. Background lighting.
- D. Modeling or high lighting.
- E. Display lighting.

At WCAU-TV the foundation lighting is supplied by specially designed high efficiency fluorescent fixtures; each fixture contains three 40-watt 3500° standard fluorescent lamps. Each lamp is mounted in an individual Alzac reflector and fed from a separate phase of a three-phase, four-wire system to reduce the stroboscopic effect. All of these fixtures can be tilted or rotated in any direction and adjusted as to vertical height (Fig. 21). The fixtures are mounted from a catwalk above the studio which also serves to support the wiring and ballast ducts. All ballasts are mounted in a standard wiring duct and are acoustically insulated from this duct in order to reduce hum noise.

Front lighting is supplied by fluorescent units of the same design as the overhead fluorescent fixtures; they are mounted on special castored stands and are fully adjustable in the horizontal and vertical planes (Fig. 20). Ballasts are mounted in an acoustically-treated box on the rear of this stand.

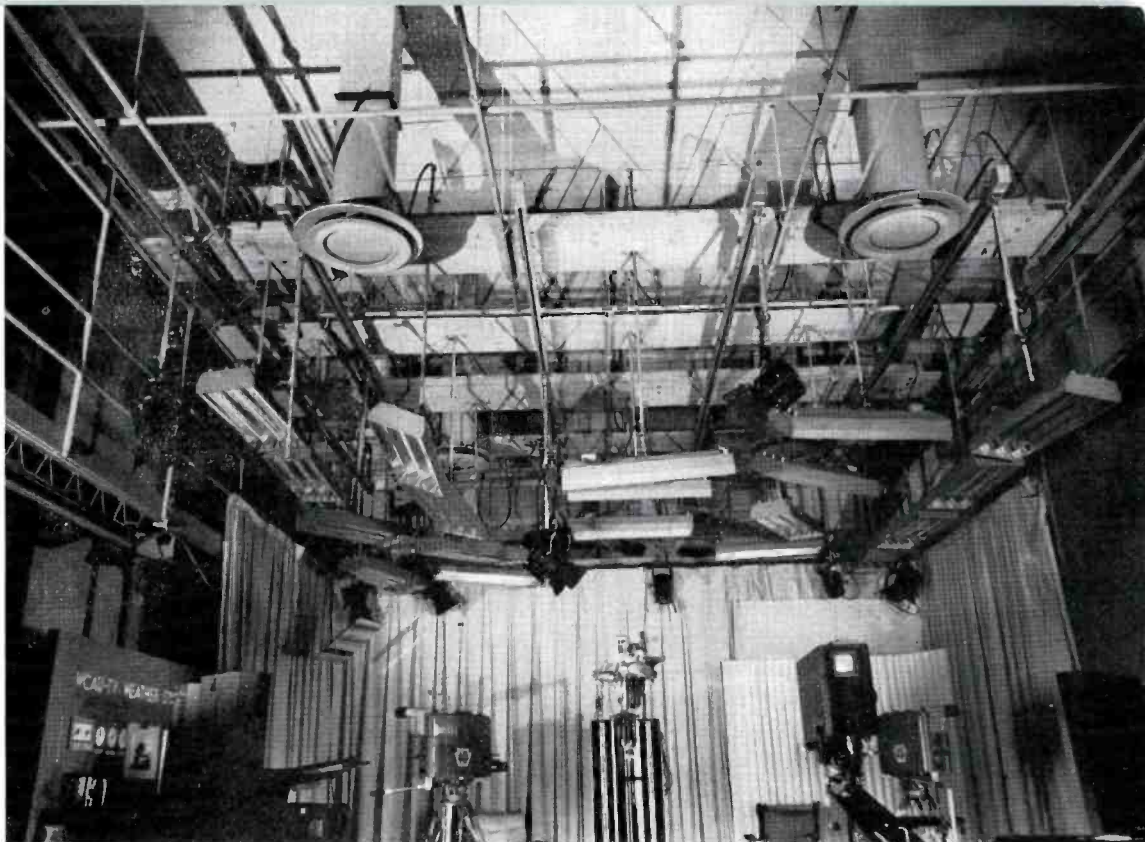

FIG. 21. Foundation lighting in WCAU-TV studios is obtained with specially designed fluorescent fixtures each of which contains three 40-watt 3500° standard fluorescent lamps. All fixtures can be rotated in any direction and adjusted as to height.

Background lighting can be obtained from proper adjustment of the overhead fluorescent fixtures or from the incandescent lights which are also used for high lighting.

High lighting is obtained from 750-watt combination spot-flood units and 1000-watt scoops. The spot-flood units are used for limited action shots and the scoops for area high-lighting. The incandescent units are mounted on trolley with electrified tracks and are adjustable in horizontal and vertical planes.

Small combination spot-floods on castored stands, stationary stands or trolley lights when necessary, are available for display lighting. Single and three phase receptacles are distributed throughout the studio at floor and bridge levels. All plugs and receptacles used are the same as those used on the remote lighting equipment in order to obtain interchangeability. All studio lighting equipment is fed from a custom-built two-position, pre-set light control panel, mounted directly behind the producer's operating position in the studio control room (Fig. 22).

This lighting equipment has been in use in the WCAU studios during the last eight months, and has given us the necessary flexibility to obtain good lighting with a limited operating staff. The use of the electrified tracks for high lighting has saved hundreds of man hours in the mounting and adjustment of lights, and the handling and maintenance of cables. The use of the fluorescent fixtures for foundation and front lighting has resulted in a reduction in the initial and operating cost of our air conditioning system.

Our experiments prior to the installation of this lighting system and our operating experience since then may be summarized as follows:

A. Avoid a low level of foundation lighting which will give dark shadows and produce a poor picture. A value of be-

tween 75 and 125 footcandles is necessary if you wish to save time in juggling lights all over the studio in an attempt to eliminate these deep shadows.

- B. Adjust high lighting for each individual scene, using the cameras in operating positions and balance lighting for all cameras, favoring the camera most used.
- C. Avoid sharp contrast in clothing. Good high lighting on a dark dress will generally mean excessive high lighting on a light suit. This also applies to blondes and brunettes. Beware of bald-headed men.
- D. Avoid jewelry with a high reflection coefficient.
- E. Tone down hot reflection points with rouge, powder or Bon Ami, when necessary. Moving an object a few inches will often eliminate the trouble.
- F. Eye glasses are a problem, but generally changing the angle of lights or camera will solve it.
- G. Avoid too much artistic highlighting, when your setup time is limited.
- H. Give considerable attention to placing your scenery and props in a position where you can effectively light the set and not limit your boom and camera action.
- I. Avoid very dark or very light backgrounds, or sharp black to white contrast in backgrounds if you wish to eliminate flaring, image trailing, washed-out scenes or faces, clothing and objects merging into the background.
- J. Avoid sharp contrast between scenes. They are not pleasing to the eye, and generally mean a poor over-all program. If you are to produce high quality pictures you must work within the technical limitations of the equipment you are using.

With the television equipment available today, it is possible to obtain pictures of high entertainment value, with excellent artistic and dramatic effects, if you have the necessary lighting facilities and these facilities are handled intelligently.



FIG. 23 (left). WCAU-TV's superturnstile antenna and WCAU-FM's two-section pylon antenna are mounted on top of a 181-ft. tower which surmounts the 479-ft. PSFS Building. Note famous statue of William Penn on City Hall in background.

WCAU-TV TRANSMITTER

We were indeed fortunate in being able to secure the one site in Philadelphia that every engineer would select as his number one choice for a transmitter location—atop the Philadelphia Saving Fund Society Building (Fig. 23). Besides being Philadelphia's tallest office structure, almost 500 feet above ground, the PSFS Building—don't try to pronounce it, it's an abbreviation that is used locally—is of modern design and incorporates nearly every construction advantage. Furthermore, it is located at 12th and Market Streets, the heart of the downtown business section and but five blocks from the WCAU-TV studios. The PSFS Building commands a sweeping view of the entire city and a good part of neighboring New Jersey. The advantages of such a location for TV transmission are obvious. WCAU-TV took over the top floor of the PSFS Building, locating its transmitter in what used to be the observation tower and erecting the antenna tower on what formerly was the observation garden. The center of the TV Turnstile is 667 feet above average terrain and 715 feet above ground. Transmission lines, however, are only 235 feet long. The top beacon is 781 feet above sea level, overlooking Billy Penn, and the highest structure in Philadelphia.

It was necessary to strengthen the building steel in the PSFS Building in order to support the weight of the antenna system. This consists of a 181 foot triangular self-supporting tower on the roof of the PSFS Building which is 479 feet above street level; a two element RCA Pylon antenna is mounted directly above the tower and used for FM transmission; a six element RCA super turnstile antenna is mounted above the Pylon and used for TV transmission; four 1 5/8 inch transmission lines are installed from the transmitting room to the antenna systems, two for TV, one for FM, and one for spare use (Fig. 26) Conductors for tower lighting and for communication circuits are carried up the tower through conduits.

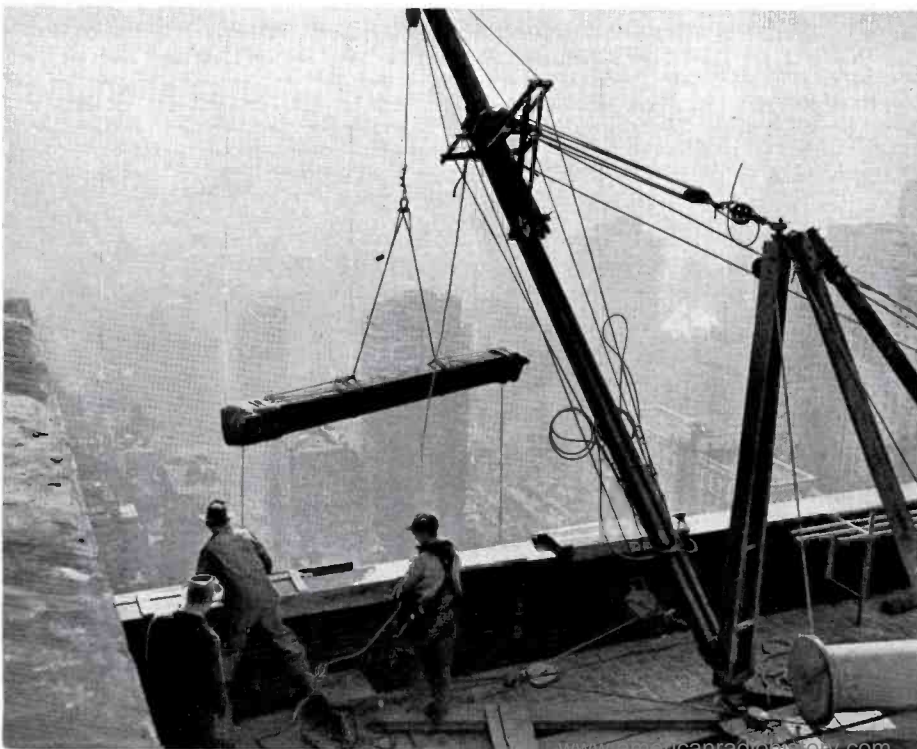

FIG. 24 (left). Much of the material had to be raised from street level on the outside of the building. Here a section of the Pylon reaches the roof level.

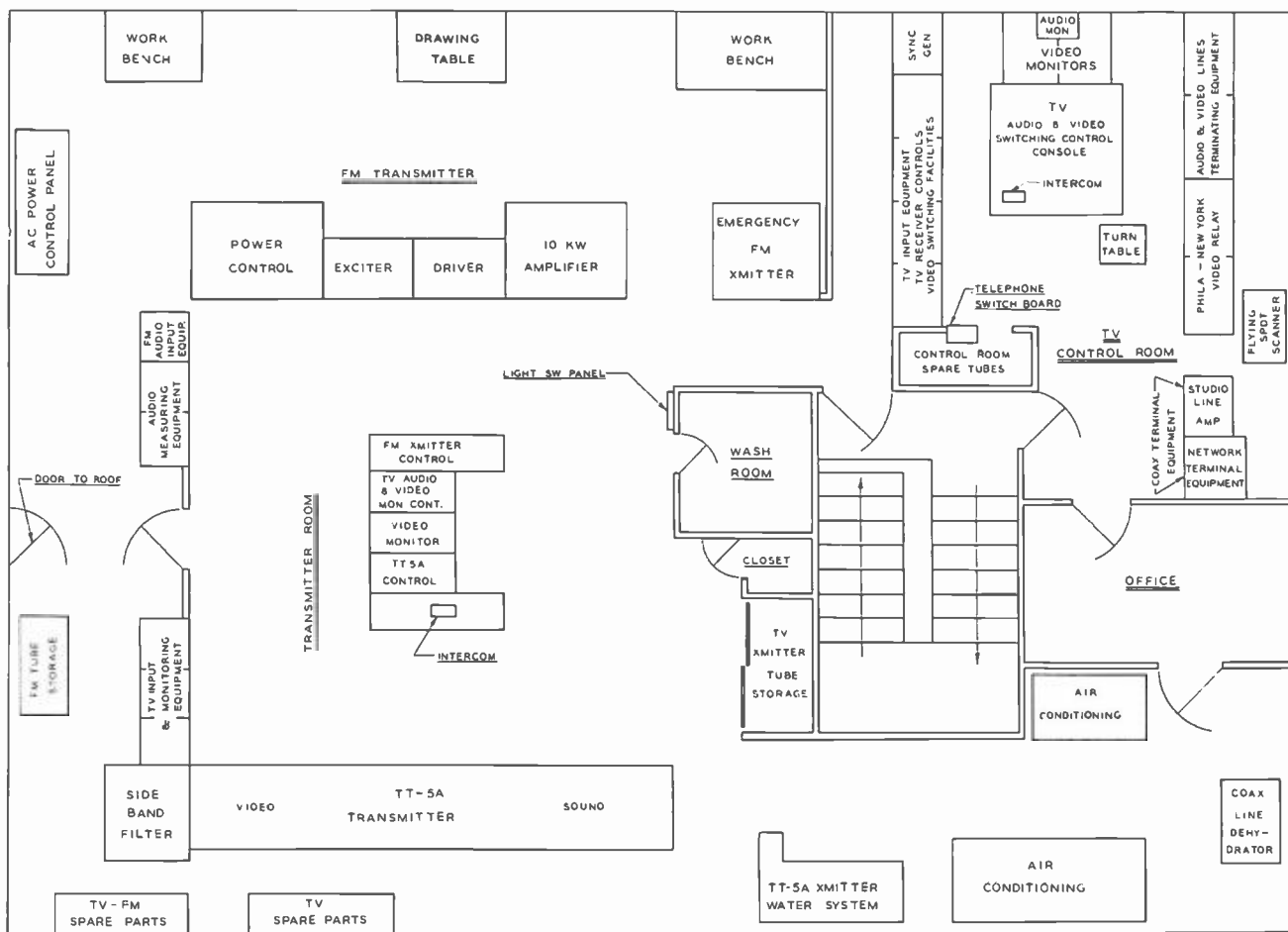

FIG. 25. Floor plan of WCAU-FM-TV transmitter installation showing arrangement of all major equipment items. Note provision of a separate TV Control Room containing terminal equipment as well as switching and monitoring equipment.

The Pylon antenna was raised in one piece and when this was in place, the completely assembled television antenna was raised as a unit by means of a gin pole and suitable rigging. The turnstile was assembled and tested at the RCA laboratories in Camden, carried by truck from Camden to the PSFS Building, and raised in one piece to the roof of this building.

One of the major problems encountered during the installation of the television transmitter atop the PSFS Building was raising the material and equipment to the transmitter location on the thirty-sixth floor penthouse. The smaller transmitter units were brought to the thirty-third floor on a freight elevator. The stairs leading to the penthouse from the thirty-third floor



FIG. 26. Four 1½-inch transmission lines, and two lighting conduits are carried up the tower from the transmitter room (see text).



FIG. 27. WCAU-TV's Transmitter (RCA Type TT-5A) is shown here (left background). Monitoring racks are at the right, control console in the foreground. This photograph is taken from a position just in front of the FM transmitter (see floor plan. Fig. 25).

level were, in most cases, too narrow to accommodate the equipment. Therefore they were raised from the thirty-third floor level to the thirty-fourth by means of a chain hoist through a trapdoor in the thirty-fourth floor. From the thirty-fourth the units were taken through a doorway and skidded up a half flight of stairs to the roof directly below the penthouse. Block and tackle was used from this point to gain the final level.

In some instances the top of the freight elevator was used as a means of conveyance to the thirty-third floor level and finally to the penthouse level by the route just described.

Larger and heavier units were raised from the street level on the south side of the building with the proverbial gin pole and motor hoist (Fig. 24). The side band filter, tower steel and antenna proper were hoisted in this manner.

The actual installation of the equipment presented some problems due to the lack of working space at the time of installation. This lack of space was due primarily, to the volume of personnel and equipment of the building trades required to convert the penthouse into transmitter and control

room space. Floors, ceilings and partitions were installed simultaneously with the wiring of the TV transmitter and control equipment. FM transmission continued without interruption during this period, using the 3 KW portion of the FM transmitter.

Before the floors were poured, wire ducts and conduits were put in their proper places. All conduit and wire duct runs were laid over copper sheets of the proper width and thickness to provide good solid common grounding. All conduits were bonded with copper straps at their joints and from these points tied to the copper sheeting. All copper strap commons were tied together at convenient points and connected to the building framework where possible. All transmitter units were grounded at two or more points. All copper water piping underneath the TV transmitter was grounded at approximately $\frac{1}{4}$ wavelength points. With this care taken in grounding there is very little apparent RF pickup at undesirable points in the transmission system.

For power service, three 500,000 cm conductors were run from the building sub-basement to the transmitter location.

480 volt 3 phase current is used to energize two sets of transformers at the transmitter location. One of these transformer sets is used for regular transmitter operation, while the other is used for general lighting and air conditioning, and may also be used for emergency operation of the transmitters in case of failure of the regular bank of transformers. In case of failure of the building supply an automatic changeover of services takes place in the sub-basement with no apparent break in continuity of service. The accompanying diagram (Fig. 25) shows the equipment placement.

The transmitter man has the TV transmitter, the FM transmitter and input-monitoring equipment within view from his position at the operating desk (Fig. 27). The control man (Fig. 28) has ready access to audio and video switching equipment, turntable and monitors. The two operating rooms are sufficiently close for co-ordination with enough separation for proper monitoring in the control room. A flat roof is on the same floor level and provides quick access to micro-wave receiving equipment mounted on the tower (Fig. 31) or on a movable dolly on the roof.



FIG. 28. View in the TV control room adjacent to the transmitter room. Operator sits at the desk containing video and audio monitoring and switching facilities. Terminal equipment and amplifiers occupy racks on either side.

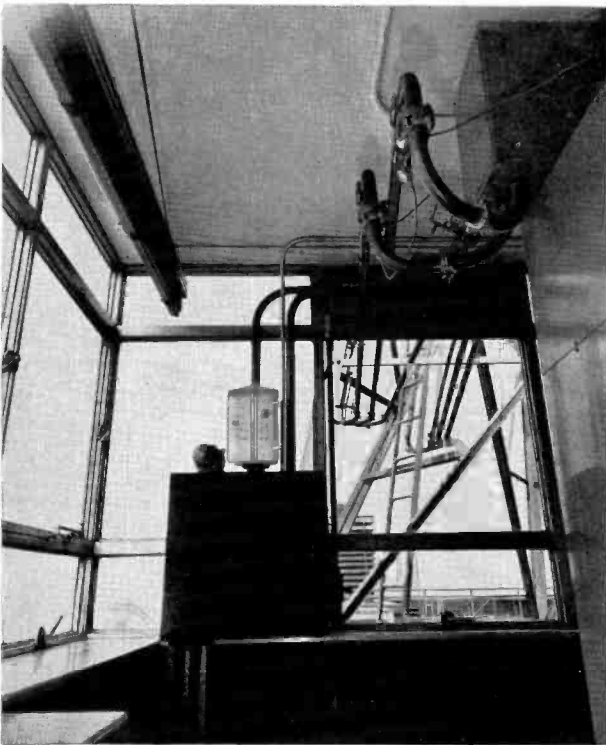

FIG. 29. The WCAU-TV transmitter is installed in what was originally the observation tower. This is a view looking out toward the base of the tower.

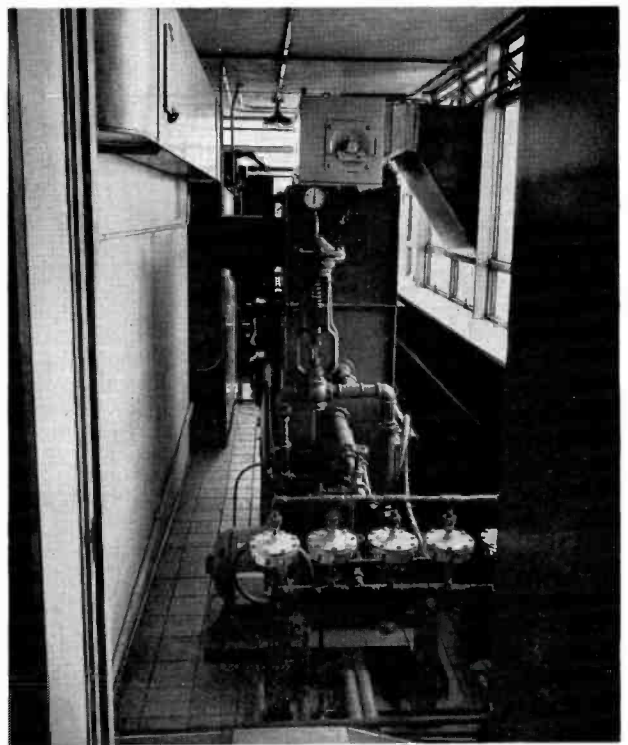

FIG. 30. This is the water-cooling unit (closed circuit type) used with the TT-5A Television Transmitter.



FIG. 31. WCAU-TV's exceptionally high tower is an ideal location for the RCA TTR-1A relay receiver used to pick up video signals from the mobile unit. The parabola shown above is mounted so that it can be oriented through a wide angle. Other positions provide for pickup from all directions.

FIG. 32. WCAU-TV's Field Equipment is a standard RCA TJ-50A Mobile Unit furnished with three camera chains, master monitor, relay equipment and accessories.



WCAU-TV MOBILE EQUIPMENT

While not available for inspection by those who visit our installation, the WCAU-TV Mobile Unit is a vital part of our operations. The TV field truck used by WCAU-TV is the standard vehicle supplied by RCA (Fig. 32). It consists of a 1½ ton Chevrolet chassis with a custom built van-type body with facilities for operation of a three camera remote program pickup. The length of the truck is 21 feet 6 inches, width 96 inches, height 111 inches and its weight empty is 8950 pounds.

At the rear of the truck a tilted shelf supports a field master monitor, field switcher unit, three camera control units, and an OP-6/OP-7 audio amplifier and mixer having provisions for four microphones (Fig. 33). Beneath the shelf, on the floor, are located the two units of the field synchronizing generator, and four power supplies for the cameras and switcher. On a smaller shelf, above the video and audio control equipment, an RCA model 630TS receiver is mounted for on-the-air monitoring. Beside this receiver the TTR-1A microwave transmitter control unit is mounted within easy reach of the video control operator. The producer's position is near the middle of the shelf and facing to the rear. On his left is the audio man, and on his right is the video control man.

The microwave transmitter is normally tripod mounted on the roof of the truck during programs. Sufficient space is also available on the roof for a camera and tripod. A trap door and ladder permits access to the roof.

Six cable reels with capacity for 200 feet of camera cable are mounted between the video equipment

FIG. 33 (right). This is a view of the operating position in the WCAU-TV Mobile Unit during pickup of a night football game (note pictures on monitor screens).

and rear doors of the truck. On both sides of the interior, cabinets are provided to store cameras, tripods, lenses, lighting and miscellaneous equipment. Between the cabinets on the left side and the video man a voltage regulator with rating of 5 KW is mounted on the floor of the truck. Above this regulator a mobile radio telephone is mounted on a shelf. This unit provides communication to any Bell Telephone so long as the truck is within range of a radio telephone receiving point. A war surplus gasoline generator is used in conjunction with the TV Field Truck where pickups are made at points having no 60 cycle AC power. This unit is mounted on a bomb trailer and generates 60 cycle 110 volts AC with a capacity of 6 kilowatts. An automatic regulator maintains the frequency at 60 cycles under varying loads. A trailer hitch has been mounted on the bomb trailer and can be attached either to the TV field truck or a station wagon for hauling.

As we look back on the building of WCAU-TV, it appears that the importance we placed on flexibility has paid dividends. During the week of February 21st to 27th we telecast 57 hours of program exclusive of News-Test Pattern operation. Twenty-six hours of this was of local origin and 16½ hours was live studio program. We believe our technical facilities and engineering personnel can keep pace with the constantly increasing and changing demands of the television art.



FIG. 34 (above). To report the election, WCAU-TV carried its cameras into the newsroom of its parent corporation, the "Philadelphia Bulletin". In this view an announcer is interviewing Harold Stassen, President of the University of Pennsylvania.



FIG. 35 (left). WCAU-TV's improvised control room at the Bulletin during the telecast of the election, shown in the view above.

HOW TO GET THE BEST PICTURE OUT OF YOUR IMAGE ORTHICON CAMERA

by H. N. KOZANOWSKI

Advance Development Group
Television Terminal Equipment Section
Engineering Products Department

Since the image orthicon camera was introduced commercially in 1945 it has developed from an interesting possibility for outdoor television pickup into a workhorse which can handle adequately any field or studio television pickup assignment. During the early period of field tests it was regarded as a mysterious and almost mystical device whose performance required the full-time attendance of an engineer. Now the image orthicon camera is almost universally used, and its adjustment and operation are so well understood that almost anyone with a little training and experience can produce a reasonably good picture with the equipment. However, television stations are no longer satisfied with reasonably good pictures, but insist on the best possible pictures that can be obtained from their cameras.

For this reason it is vital to review critically the many factors that go into making the best image orthicon picture and from this to present a guide to be followed in setup and operation of image orthicon field and studio equipment. One of the most disturbing feelings which operators have experienced is that of obtaining an excellent picture at one time with a given setup and only a passable or mediocre picture at another time under apparently the same conditions and with the same equipment. It is hoped that the following discussion will bring out the reasons for paying attention to those operating conditions which will insure the best possible and the most uniform picture production from day to day and from camera to camera.

The analysis which follows is based directly on the premise that the operator is familiar with the material covered in the instruction manual for field and studio camera equipment and has, therefore, a

working knowledge of the location of controls and the procedures recommended for set-up and adjustment. The approach to the problem is that of clarifying and emphasizing the information in the instruction manual and pointing out as concretely as possible the effect on picture quality of the various factors under control of the operator. It is not intended for use in instructing an operator on procedures for producing an image orthicon picture, but rather as an organized set of procedures for making an image orthicon picture better.

Alignment

A logical starting point in producing the best picture is the matter of scanning beam alignment. This alignment is accomplished by the use of a rotatable yoke over the electron gun of the image orthicon tube. Current from the focus field regulated supply is passed through the windings of this yoke to establish a crossfield in the gun region. The magnitude of the field is controlled by the setting of the alignment potentiometer and its direction is controlled by mechanical rotation of the yoke assembly with respect to the tube. In this way it is possible to correct electrically any small mechanical misalignment of the electron gun which may be present with respect to the longitudinal axis of the tube. Alignment removes the radial component of the scanning beam, and causes it to coincide with the scanning axis of the tube. Proper alignment conditions can be recognized by the following easy test:

When alignment is correct the picture as seen on the kinescope will not rotate or swirl as the orthicon focus voltage is varied about its best-focus position; it will merely go in and out of focus. An even more critical test is that of observing dynode or multiplier spots which are most

prominent with no illumination on the photocathode when the amplitude and direction of alignment are varied. When alignment is correct such spots will not rotate, but will simply go in and out of focus as the orthicon focus control is varied. The importance of best alignment resolution, signal-to-noise ratio and overall picture quality cannot be overemphasized.

With present tubes which are very carefully assembled the alignment current required is very small. Therefore, it is reasonable to start with the alignment potentiometer very close to its zero position and to rotate the coil with small changes in this current to determine conditions for correct alignment as previously discussed.

It should be pointed out that if the focus field current is changed the alignment may no longer be correct for the new operating condition. A fixed value of 75 ma. in the focus field current, which corresponds to a magnetic field of 75 gauss in the center of the focus coil is recommended for optimum performance in both field and studio cameras and should be used for aligning the scanning beam.

Do not attempt to adjust performance by varying the focus field current as it leads to misalignment of beam, change in orthicon focus voltage, and change in image focus voltage. This unduly complicates adjustment procedures, offers no advantages over the standard methods which have been recommended and should, therefore, be avoided. One should keep in mind that a given focus field automatically determines both the orthicon focus voltage and the image focus voltage for an image orthicon tube. Manufacturing tolerances are now held to such narrow limits that tubes can be switched in a camera and after alignment of the scanning beam, only vernier adjustments of orthicon and image

focus voltages are necessary to get optimum focus conditions.

To summarize:

1. Adjust scanning beam alignment current and direction until the viewed picture does not rotate or swirl as the orthicon focus voltage is varied about its "optimum focus" value, but merely goes in and out of focus.
2. "Multiplier spots," visible with no light on photocathode (or lens capped) can be used very effectively in making alignment adjustments. They should not rotate or swirl, but should merely go in and out of focus on adjusting the orthicon focus control.
3. Operate at a fixed focus field current of 75 ma. for field and studio cameras, and make alignment adjustments under these conditions. This will give orthicon focus in the neighborhood of 180 volts and image focus in the neighborhood of 450 volts.
4. Do not attempt to adjust for best operation by varying the focus field current. This introduces complications which are very difficult to handle in practice.
5. Practice the technique of alignment until it becomes intuitive. Once this procedure has been acquired it becomes precise and can be carried out in as little as two to three minutes with assurance of uniform performance. Remember that a poorly-aligned camera will never give a good picture no matter how carefully we carry out the other essential conditions which are still to be discussed.

Scene Reproduction and Picture Quality

In order to restrict the scope of this discussion we shall assume that the orthicon decelerator grid voltage G_3 has been set to get best corner focus or flattest field, that the multiplier focus voltage is set to obtain maximum signal output consistent with a flat field, and that the image accelerator, G_4 , is set to get minimum "S" distortion (about 80% of image focus voltage). The camera should then be in such adjustment that we can discuss the problem of scene reproduction and picture quality effectively.

Television scenes can be divided into two main types as far as the camera is concerned. The first occurs in televising outdoor events in which the lighting is not under the operator's control, and the second, of which studio pickup is an example, is such that the lighting is, or can be, under almost complete control. Let us examine the conditions required for best pictures in these two categories.

In an outdoor pickup, using an f:2.8 lens and a 2P23 image orthicon tube, the minimum incident scene illumination for satisfactory signal-to-noise ratio is 15 to 25 foot candles. For the RCA 5769 the minimum is 20 to 30 foot candles. On those infrequent occasions when the light level falls below these values the picture will suffer some deterioration, principally by an increase in noise content, but will still be quite usable if the camera is given a chance to work to best advantage.

It is perhaps most instructive to start from a "normal" outdoor lighting level of 300 to 500 foot candles on the scene and to trace the importance of factors which *can be* under an operator's control and to show that these factors play a very important part in determining picture quality at any light level. The 300 to 500 foot candle level chosen for discussion is rather arbitrary since much higher levels can be encountered on bright sunny days.

An operator has the following factors to consider in the pickup of a scene:

1. Focal length of camera lens.
2. Lens opening or f: number setting.
3. Target potential of image orthicon.
4. Beam current setting of image orthicon.
5. Scene composition.

How does he make a proper and practically automatic choice of these factors to obtain the best possible picture the equipment can produce?

With the lens turret on the image orthicon camera there are four possible choices of lens focal length. The lenses may vary from a wide-angle to a 25 inch telephoto and the one selected will depend entirely on the distance of a camera from the scene and the field of interest required at any given moment. So far, these observations fall into the "irrelevance of the obvious" category. In brief, the operator chooses the lens he needs.

From this point on, things get more interesting. The amount of light falling on the image orthicon can be varied by 130 to 1 for the 50mm Ektar lens, or 30 to 1 for the 135mm Ektar by variation of the iris settings in these lenses. The image orthicon is a remarkable tube in its latitude to light, but gets much more cooperative when treated with consideration. How much light shall we give it?

The best way to answer this question is to observe the scene we have chosen for discussion with a camera, starting with the iris at f:22 and gradually opening the iris until it is wide open. The picture will start

out by being noisy and will improve as the lens is opened, the highlight signal output growing with the increase in the amount of light. However, a well-defined iris setting is soon reached where the highlight signal no longer rises as rapidly as before. The transition point is called the knee of the image orthicon operating curve. The recommended operating conditions are those with the highlights slightly above the knee of the curve. These will give the most natural scene reproduction with "black" blacks and best gray scale possible. Operation with highlights farther above the knee will result in poor grays and compressed highlights and give a picture which is "artificial" and not too pleasing to the viewer. This matter of light-level adjustment is so important that it is worthwhile restating the argument in the following form:

"For the most natural appearance of television subject or scene, an image orthicon should be operated so that the highlights on the photocathode bring the signal output slightly above the knee of the signal-output curve for the type of illumination utilized. The knee is that point where the signal from the highlights begins to drop appreciably as the lens opening is decreased in size. Operation at this point is especially important for studio pickup in order to obtain the best gray-scale in the picture and to reduce the possibility of image retention."

"For outdoor scenes where a wide range of illumination may be encountered, and the best lens opening cannot be set for each scene, the optimum setting is that at which the highlights of the least illuminated part of the scene bring the signal output just above the knee. The camera will then be able to handle, without serious deterioration of picture quality, all other degrees of illumination in the scene without any change in the lens stop. In other words, the camera should be set for the darkest area of the scene, and then panned into lighter areas, as opposed to being set on a bright area and panned into a dark area."

These paragraphs have been quoted directly from general suggestions on image orthicon operation prepared by the Tube Department of the RCA Victor Division.

Beam Current and Target Potential

This discussion of light-level control by adjusting the lens opening or iris setting has been based on the best operating conditions for the image orthicon tube. At this point it is essential to define these condi-

tions more precisely. The two adjustments which have direct bearing on picture quality are image orthicon beam current and target voltage. How do we choose the correct settings?

The beam current starting at the electron gun is strictly d-c or constant in time. In the process of scanning, electrons are attracted to the target to neutralize the target charge image created by light falling on the photo-cathode. These are subtracted from the original beam current to *modulate* the returning beam, thus forming the video signal. The return beam going through the five-stage paddle-wheel electron multiplier undergoes *current* multiplication to produce video signals which are 500 or more items greater than those available in the return scanning beam. These currents flow in an output resistor, giving a high-level video signal voltage which is amplified and compensated in the usual manner.

It is immediately evident that in a black portion of a scene *all* of the scanning electrons come back to the multiplier. In the highlights, however, only a fraction of the electrons return, as the others are removed from the original beam to neutralize the charge on the target.

Let us assume that for a given picture the beam current is deliberately increased. In the black portions of the picture *all* scanning electrons return to the multiplier. In the highlights, only a small fraction of the beam electrons are required for discharge, the remainder returning to the multiplier. The percentage modulation is poor and since the beam noise is proportional to the square root of beam current, the signal-to-noise ratio of the picture deteriorates. The technique of obtaining highest signal-to-noise ratio is that of operating with just enough beam current to "hold down" or discharge the highest highlight in a scene. In practice some allowance or reserve must be provided for the possibility of a still higher highlight being introduced during the action. However, there is nothing to be gained by the use of "excess" beam current and very much to be gained by the careful adjustment previously discussed. This brings up the observation that isolated highlights which have nothing to do with scene continuity or dramatic importance should be religiously avoided. Holding down such highlights may require such an increase in beam current that the "normal" portions of the picture will suffer in signal-to-noise ratio. Scenes which have a controlled contrast range are much more readily and smoothly handled than those in which highlights "run away." In

general, studio pickups will permit careful control of scene composition. In the case of outdoor pickups such as baseball, boxing and similar events the best solution to the difficulty is to avoid extreme highlights wherever possible. Pointing at the ceiling to show that the lights are turned on is certainly not a vital part of a boxing match.

We are now in a position to discuss target voltage and its effect on picture quality. The range of target voltage control is approximately -3 to $+3$ volts d-c. If this setting is made more negative while viewing a picture, a point will be reached where no picture will be seen. This is the cut-off voltage of the target. Careful study has shown that the best operating voltage for the target is 2 to 2.5 volts more positive than the cut-off voltage, with the beam current adjusted to discharge the highest highlights under these conditions. The cut-off point and correct operating voltage can be determined and set using a high resistance voltmeter from the center arm of the target potentiometer to ground. In the beginning, it is advisable to check this setting on a camera rather than to rely on the intuition which comes only with continued practice in setup and operation.

If the target is operated closer to cut-off than has been recommended, the gray scale rendition will deteriorate, with compression of the blacks, and the signal-to-noise ratio will suffer. To prove the importance of target voltage on transfer characteristic or gray-scale rendition, one can try to obtain a picture with the target operated at a fraction of a volt above cut-off. The results can be summarized in one word: horrible. The blacks and grays will be compressed to the point where there is practically no discernable detail in the low-lights, the picture is muddy and the signal-to-noise ratio is very poor. The transition from correct operating voltage to the absurd case which was used as an object lesson is smooth, and the choice of "best" target voltage is therefore one of the more subtle variables in operating techniques.

The more positive the target, the more beam current is required for discharge of highlights. The upper limit is therefore set by the ability of maintaining a well-focused beam to obtain resolution in the highlight details. Therefore the target setting can be made slightly less positive than this upper limit to provide some latitude in scene illumination range, with practically no sacrifice in gray-scale rendition. At times there is a temptation to "hold down" highlights by operating with a more negative target potential when the correct procedure is to stop down the lens iris to the appropriate

setting as previously discussed. The target-biasing procedure leads to gray-scale compression and should be avoided.

Scene Illumination

A guide to scene illuminations required for satisfactory pickup is very useful. The following section is directly quoted from recommendations made by the Tube Department of the RCA Victor Division on image orthicon operation.

"Before attempting to televise a particular scene, it is good practice to check its illumination with a light meter to determine whether the light level is adequate for a picture of good quality. In general, the illumination should be measured in a vertical plane with the light meter at the scene pointing toward the camera."

With an F:2.8 lens, the minimum incident illumination on the scene is given in the following table for the different types of image orthicons. The values are conservative and will vary somewhat for individual tubes.

Tube Type	MINIMUM SCENE ILLUMINATION (Foot-Candles) With f:2.8 Lens		
	Daylight	Tungsten Light (Incandescent)	Fluorescent
2P23	15-25	15-20	25-35
5655	—	150-250	100-150
5769	20-30	30-40	20-30
C-73150	4-8	5-10	4-8

When lens openings smaller than f:2.8 are used to obtain greater depth of focus, the illumination required will increase with the square of the ratios of the f:numbers.

For daylight scenes using the 2P23 or the 5769 set the lens opening in accordance with the following table.

INCIDENT ILLUMINATION ON SCENE	Lens Stop
Clear Sun—10,000 foot candles.....	f:22*
Bright Daylight	f:22
Hazy Sun—1,000 foot candles.....	f:16
Cloudy Bright	f:11
Open Shade—140 foot candles.....	f:8
Cloudy Dull	f:5.6
Deep Shade—30 foot candles.....	f:3.5

* Used with neutral density filter of 25% transmission.

The use of a lens shade is beneficial under almost all conditions. A lens shade effectively prevents stray light (from points outside the picture field) from reaching the photocathode. Since the image orthicon tube is very susceptible to stray light as far as gray scale rendition is concerned, remarkable improvements in tone-reproduction have been observed under stray-light conditions when a sunshade is used.

The various factors which go to make up picture quality have now been discussed sufficiently to provide a logical background for setup and operation of cameras. If the recommendations in this discussion are followed in practice, uniformly excellent pictures are the reward.

From the viewpoint of producing the best possible television picture the discussion so far has touched on "normal" operating factors and has assumed that these exist in practice. It is therefore necessary to list departures from normal and point out their effects. These have been summarized in a publication by the Tube Department of the RCA Victor Division as "Don'ts." Because of their importance and for the sake of completeness, they are included in somewhat revised form. They are:

1. Don't operate an image orthicon without scanning.
2. Don't underscan target.
3. Don't use an image orthicon for pickup until it has come up to normal operating temperature.
4. Don't focus an image orthicon on a stationary bright scene for more than a few minutes.
5. Don't operate an image orthicon having an ion spot.

A brief discussion of each of these points will give the reason for observing the recommendations which have been made.

1. Failure of scanning for even a few minutes when light is incident on the photocathode may permanently damage the surface of the target. The damaged area will show up as a spot or a line in the picture during subsequent normal operation.

If scanning should fail, cut off the beam current at once by increasing the image orthicon beam bias to its most negative value. When the camera is left unattended, precautions against possible damage due to scanning failure should be taken either by cutting off the beam current or capping the lens.

2. The target should always be scanned to full size. Full-size scanning can be assured by first adjusting the horizontal and vertical deflection controls to make the corners of the target visible in the picture, and then reducing the scanning until the corners just disappear. In this way, since the maximum scanning area is used, maximum signal-to-noise ratio and maximum resolution capabilities of the tube can be realized.

It must be noted that *overscanning* the target produces *smaller* than normal-sized

objects in a picture, as viewed on a monitor kinescope.

Underscanning of the target should never be permitted. If the target is underscanned for any appreciable length of time, a permanent change of target cut-off voltage of the underscanned area takes place with the result that the underscanned area thenceforth will be visible in the picture when full-size scanning is restored.

3. When a camera is turned on, the image orthicon tube will warm up from the ambient room temperature to its recommended operating temperature in one-half to one hour. The element which is most sensitive to operating temperature is the glass target the electrical resistivity of which decreases rapidly with increase in temperature.

The operating temperature of the target in the 2P23 and 5769 tube should be at least 35° C., and that of the target in the 5655, at least 45° C. Operation at lower than the above temperatures will be characterized by the appearance of a rapidly disappearing "sticking" picture of opposite polarity from the original when the picture is moved.

The operating temperature of the target should never exceed 65° C. Operation at too high a temperature will cause loss of resolution and possibly permanent damage to the tube. Resolution is regained only by waiting for the temperature to drop below 65° C.

For outdoor pickups in cold weather, it may be necessary to use the target heater to shorten warmup time and to maintain correct operating temperature. Ordinarily, with the blower operating, the temperature will not exceed 65° C. unless the target heater is on for a long period. In very hot weather, the direct rays of the sun should be kept from reaching the camera.

4. If a camera is focused on a stationary bright picture for more than a few minutes, retention of scene, sometimes called a "sticking picture" may result. Often this picture will disappear in a few seconds, but sometimes may persist for long periods before it completely disappears.

To avoid retention of a scene, always allow the tube to warm up properly before pickup of a scene, and never allow the tube to be focused on a stationary bright scene for more than a few minutes. Never use greater lens iris opening than necessary.

A retained image can generally be removed by focusing the image orthicon on a matte white surface and operating with

a fairly high illumination level. Another possibility is that of switching the lens turret to an open position and using general room illumination directly on the photocathode to carry out the "wipe-off" process.

5. An ion spot may occasionally be observed in an image orthicon. It can be identified as such if it occurs in the center of the raster and does not change in size when the orthicon focus is varied, under conditions of no light on the photocathode. If the spot begins to grow in size with continued operation, the tube should be removed and returned for reprocessing. Continued operation, with ion spot, will eventually damage the target permanently.

After an image orthicon tube has been operated for 200 to 300 hours, it should be given an idle period of three to four weeks during which time it will regain much of its original resolution and sensitivity.

Spare image orthicons should be placed in service for several hours at least once a month in order to keep them free from any traces of gas which may be liberated during prolonged storage. New image orthicons should be tested immediately on receipt. They should be operated for several hours before being set aside as spares.

This discussion has presented recommendations on image orthicon operation and pointed out pitfalls which may be encountered both in setup and in operation. It is in a sense a digest of the available research, development and field experience. Those who are interested in a detailed critical analysis of the effects which have been discussed will find the paper of Janes, Johnson and Moore to be published in *RCA REVIEW* later in 1949 of great value. The series of papers by Otto Schade in the *RCA REVIEW* on electro-optical characteristics of television systems contains undoubtedly the most thorough analysis of the television pickup and reproduction process and includes an excellent discussion of the transfer characteristics of the image orthicon.

The Television Terminal Equipment Group is indebted to Dr. Janes and Mr. Schade for many discussions on the problems of image orthicon operation and for access to much of the material presented in this discussion.

References

- "Development and Performance of Television Camera Tubes." R. B. Janes, R. E. Johnson and R. S. Moore. To be published in *RCA REVIEW* later in 1949.
- "Electro-Optical Characteristics of Television Systems." Otto H. Schade, Parts I to IV. *RCA REVIEW*, Vol. IX, No. 1, 2, 3 and 4.
- RCA Tube Bulletins for Types 2P23, 5769, and 5655. Tube Dept., RCA, Harrison, N. J.

THE "Berkshire" A RADIO-PHONOGRAPH BUILT TO TRANSMITTING EQUIPMENT STANDARDS

by MARVIN HOBBS



FIG. 1. The several cabinet models in RCA's Berkshire series (see opposite page) were designed by America's foremost stylists. The complex tuning dial and mechanism was designed by John Vassos (shown above), noted designer of RCA's transmitter equipment.

The Consumer Custom Products Department of RCA Victor is now producing something every broadcast executive has wanted for years—i.e., a home receiver matching his transmitter in fidelity of performance, and built in the same way and from the same quality components as his station equipment.

Station engineers especially have long been aware of the relative inadequacies of ordinary receivers. Not a few of them have solved, or attempted to solve, the problem by themselves assembling "broadcast type" components and building these arduously into a custom installation. Some of them have, by this means, achieved spectacular results, others have failed because no truly matched set of components was readily available and compromises usually led to unsatisfactory results. In any event this home construction is no longer necessary for RCA Consumer Custom Products engineers have taken the hint and have done

just what these pioneering station engineers have been trying to do for years—namely, to assemble a set of matched "broadcast type" components into a radio-phonograph combination equal in every way to the best broadcast station equipment.

It is worth noting that the availability of these new RCA receivers not only makes it unnecessary for station engineers to "roll their own", but it also—and perhaps more important—makes it possible for managers, program directors, advertisers, and other non-technical people to own a radio-phonograph of professional quality. Two of these "Berkshire Series" instruments also contain large-screen projection television.

True "Broadcast Type" Components

The idea of a "broadcast quality" receiver is, of course, not new. Receivers intended to meet this standard have been advertised from time to time. However, most of these were simply souped-up versions of ordinary home receivers in which various stratagems were used to improve

FIG. 2. The cabinets are built in the plants of outstanding furniture makers. They are made of the finest woods by experienced craftsmen, and are exquisite in their hand-worked detail.



FIG. 3. The electrical components used in the Berkshire receivers are all of "broadcast quality." The r-f tuner which is shown below, for example, is copied from the famous AR 88 Receiver, RCA's outstanding commercial receiver.

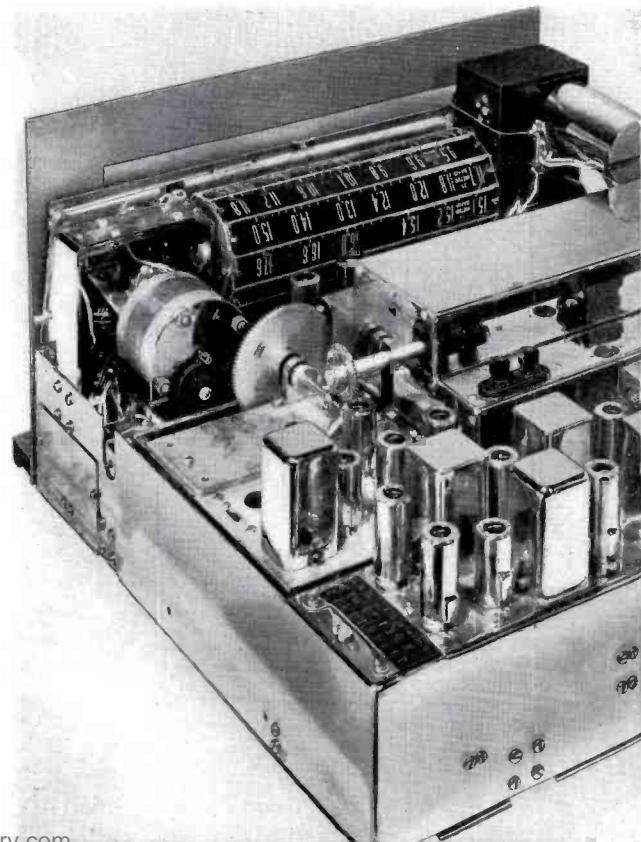

FIG. 4 (right). Three of the models in the Berkshire series are shown here. At the top is the Regency, in the center the Contemporary, and at bottom the Modern. Other models, not shown, are the Breckfront and the Secretary. In addition the Berkshire components are available for built in installations (see Page 84).

the overall response — without actually changing the fundamental design.

The Berkshire Series receivers are entirely different in design—and they are made up *in every instance* of professional-type components. The r-f chassis, for example, is a specially-built unit similar in general design to RCA's best-known professional receiver, the AR-88 Communications Receiver. The push-button tuning system employs an auto-tune unit of the type heretofore used only in high-priced commercial and military gear. The amplifier, similar in design to standard RCA broadcast amplifiers, is a 40-watt job using four 6L6G's push-pull parallel in the output stage. The speaker is the famous duocone ("Olson speaker") identical to the unit in the deluxe broadcast type LC-1A speaker. Dr. Olson acted as consultant on the audio features of the "Berkshire." A part of the audio system is a new dynamic type of "threshold" noise suppressor, offering marked advantages in the suppression of record surface noise, thermal noise

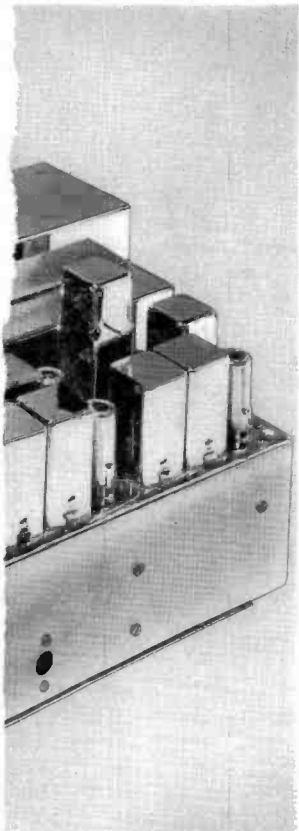



FIG. 5. The Breakfront and Regency models are available with television. Shown above is a view of the Regency with front center doors open to show television screen and controls.



FIG. 6. All five models include a high-quality phonograph with automatic record changer. Above view shows the phonograph "drawer" in the right side of the Regency model.

and other undesirable disturbances. This suppressor, as well as the tuner, amplifier and loudspeaker, are described in greater detail below.

The R-F Tuner

Behind the gold-plated front panel which was styled by John Vassos, there is a dual channel superheterodyne system incorporating 23 tubes and tuning through the range of 530 kc to 22.5 mc for AM reception and 88 to 108 mc for FM reception (Fig. 3). Any band may be selected automatically by depressing the corresponding push-button in the row directly below the dial scale window. Automatic tuning of AM and FM Broadcast stations,

as well as selected AM shortwave stations is provided at the keyboard below the four main knobs. Separate "phonograph" and "television" keys automatically select these services. Small horizontal knobs regulate the bass and treble response and control a calibrated scale which shows the unattenuated portion of the audio spectrum which is being passed by the system. The four large knobs, from left to right, control "volume", "noise suppression", "variable selectivity and sensitivity" and "manual" tuning.

The basic design of the AM portion of the tuner is similar to that of the AR-88 communications receiver. Three degrees of selectivity are provided to allow the lis-

tener to choose the maximum usable fidelity for a given set of listening conditions. Fig. 3, showing the tuner chassis in a top view, portrays the completeness of the design with respect to tuning elements which are housed in the small shield cans, along the rear of the chassis; and under the large shield cover in the middle of the unit. Two stages of tuned r-f amplification and three stages of i-f amplification provide for optimum sensitivity. A total of twelve tuned circuits in the i-f amplifier establish a high degree of adjacent channel attenuation, even under the conditions of expanded operation.

The FM Tuner channel consists of two tuned r-f stages a pentode mixer with a separate double triode oscillator, an AFC circuit, four i-f stages and a ratio detector. As shown in Fig. 7 the ganged permeability tuner is of considerable interest. In this unit four molded iron cores, attached to a common mounting plate and driven through a stabilized lead-screw arrangement, move concentrically with respect to four individual glass coil forms. The conductors for the four inductances are formed by spiral layers of powdered metal deposited on the glass. This arrangement is necessary to provide optimum gain for weak FM signals, bringing them up to a level capable of furnishing satisfactory service. The AFC system keeps the oscillator properly tuned with respect to the detector characteristic so that distorted FM reproduction may be avoided. The ratio detector is of the latest design with proper construction for balanced operation and maximum rejection of AM.

FIG. 7. This ganged permeability tuner is used in the r-f tuner of the Berkshire receivers. Four molded iron cores, with a common drive, move concentrically with respect to four individual glass coil forms.

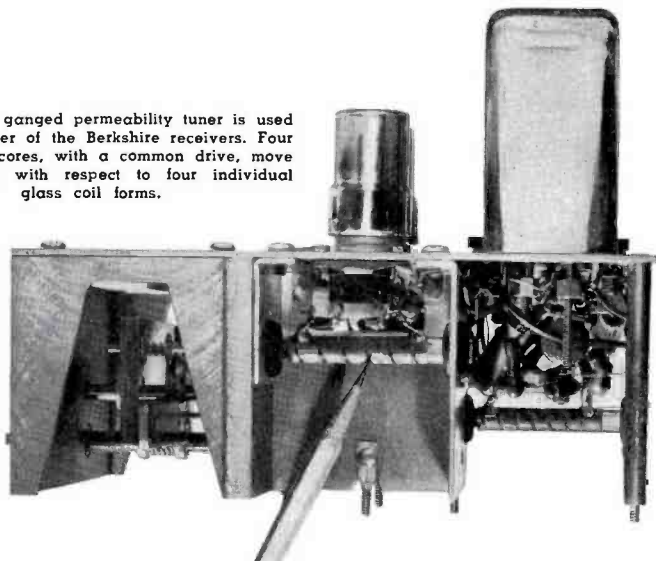
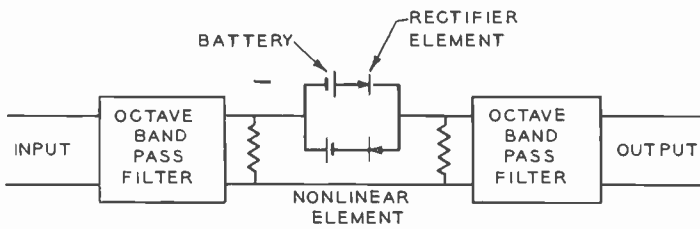
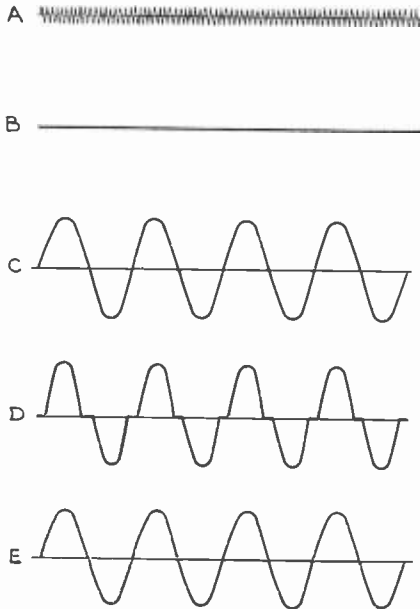

FIG. 8. BASIC OPERATION OF THE THRESHOLD NOISE SUPPRESSOR



I. A single channel of the noise suppressor consists of a non-linear element with input and output bandpass filters which cover one octave.



III. These figures illustrate the response of the non-linear element to noise and sine wave signals. A is the noise input to the system. B the noise output from the system. C a sine wave input to the system. D the complex wave output from the non-linear element. E the sine wave output from the system.

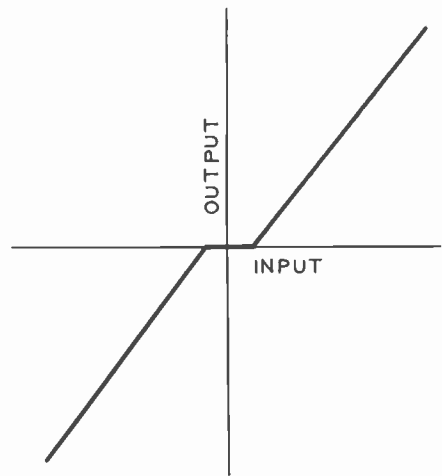

II. The amplitude characteristic of the non-linear element has the shape shown here. If the noise input to the system is kept below the response range of the non-linear element, it will not be reproduced.

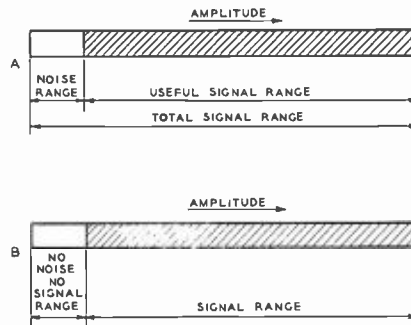

IV. This illustrates the gain in signal-to-noise of the system. A shows the amplitude ranges of the signal, the noise, and the useful part of the signal input from a record. B shows the amplitude range of the signal and of the "no-signal, no-noise" range of the output of the noise-reduction system. The system reduces the noise and thereby increases the signal-to-noise ratio.

The Threshold Noise Suppressor²

It is well known that the signal-to-noise ratio of sound reproducing systems may be increased in a number of ways. After considerable investigation the threshold type was chosen for the Berkshire because it offered the advantages of freedom from time lag and could be adjusted so that it can be switched in and out simply without a multiplicity of adjustments for each record or program. With this system the audio spectrum is divided into octaves and fed through rectifying elements having substantial cut-off below their threshold level. The lowest octave is passed through unaffected, but is set low enough to cut off an appreciable amount of the high frequency noise spectrum where most of the disturbing portion of the record surface noise is situated.

When the audio level is very low, as it is with thermal noise, record surface noise and other types of fluctuation noise, the upper octaves are practically cut off. However, as soon as the program level exceeds the threshold of cut-off the signal is passed through in all channels and the masking effect of the music and speech with respect to the noise is relied upon to a large extent to render the noise inaudible. It is the effect of reducing the noise appreciably during the quiet periods of the reproduction that results in the outstanding performance of the system.

Fig. 8 shows the basic structure of a single element of the threshold noise suppressor. In the Berkshire three channels (two controlled and one uncontrolled) are utilized. The low frequency channel passes

from 30 to 2500 cycles approximately; the mid-channel passes 2500 to 5000 cycles and the high channel passes 5,000 to 10,000 cycles. The two upper channels have as much filtering as is practical ahead of the rectifying elements to keep the overall harmonic percentages below 2%. It is essential to utilize many of the possibilities of series and parallel resonance near the edges of the pass bands to hold the level of distortion in the cross-over region of the filter networks, because of the inherent distortion of the rectifying elements following the networks. To regulate the threshold level of the rectifiers, two crystals are connected in series in each path to accumulate sufficient contact potential. The rectifiers are connected back to back to provide conduction on both halves of the audio cycle. To

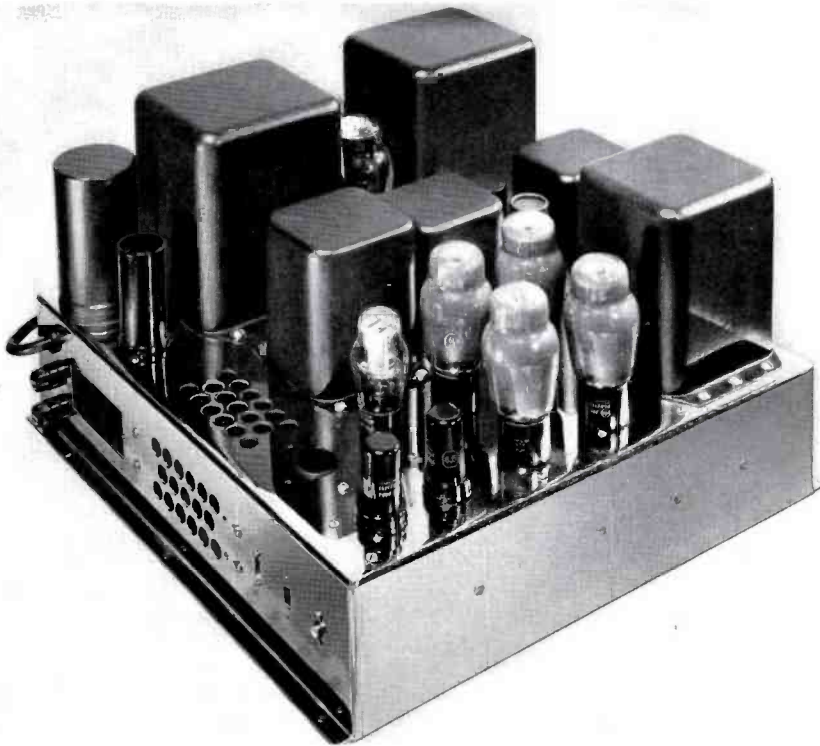

FIG. 9. This is the 40-watt (3% distortion) "broadcast-type" amplifier used in the Berkshire receiver.

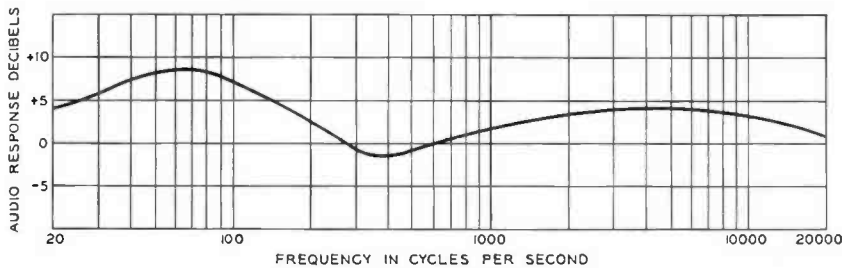

FIG. 10 (above). Overall audio response of the Berkshire amplifier with tone control compensation added.

permit the playing of records having various degrees of distortion in the high frequency range, additional positions on the suppressor switch attenuate the high frequency channel. The suppressor is effective in AM, FM and phonograph reproduction. As mentioned above, high grade records of properly controlled manufacture, such as the new X type, will be satisfactory without suppression provided they have not been scratched or otherwise damaged.

The Audio Amplifier

The basic audio system, with a fidelity characteristic which is substantially flat across the range of human hearing, consists of four 6L6G tubes in push-pull parallel with negative feedback from the output transformer to the cathode circuit of the second audio stage. Through the use of negative feedback and a properly designed output transformer the transient response of the pentode amplifiers are made comparable with those of triodes. A maximum power output of 40 watts with 3% distortion is realized. The overall audio fidelity of the amplifier with tone control compensations included is shown in Fig. 10. The RCA Duo-Cone was described in an earlier issue of BROADCAST NEWS.¹ By examining Fig. 9, the top view of the audio amplifier and power supply chassis, one becomes aware of the ample margin of design in the audio components and of the marked similarity to broadcast studio equipment. Six amplifiers, one voltage regulator and two rectifiers form the tube complement.

Design Background

At the time this equipment was designed it was felt in some quarters that the audio frequency capabilities of the system were too far ahead of the commercially avail-



able records and that the full performance of the system could be realized only on an occasional FM program of live talent in a direct pickup. However, the recent introduction of the X record, with its low noise and distortion, as compared with standard shellac pressings, has placed the commercially available record in a position to match Berkshire audio performance. In fact, the Berkshire can be operated with full fidelity (full treble and full bass) on the new records without noticeable noise or distortion, thus providing the record enthusiast with a new level of home entertainment. In addition, by the flexibility of its noise suppressor and fidelity control adjustment, the most desirable response for conventional records, and FM and AM programs, can be selected regardless of noise content or distortion on the available material.

Large Screen Television

Projection television with a 15 inch x 20 inch screen is standard equipment in the television combinations of the Berkshire Series (Fig. 5). A black and white picture is projected from the fluorescent screen of a 5-inch cathode ray tube. To obtain a high efficiency of light transfer the Schmidt type optical system is utilized as a projector. Its efficiency is approximately 25%, as compared with less than 6% for conventional refractive optical systems. A spherical mirror of 14 inches diameter, with a plastic aspherical corrector lens, focuses the picture on a special RCA screen at a point 34 inches from its center of curvature. The screen, a rear-projection type, provides a light gain of approximately 6 due to its favorable pattern, which is established by the Fresnel characteristic molded into its surface.

Other outstanding features of the television unit are full frequency coverage, picture AGC, AFC, horizontal hold control, stabilized vertical hold, two stages of video amplification, noise saturation circuits, three stage syn separator and clipper, 4 mc bandwidth for the picture channel and reduced hazard voltage supply.

Available in Various Cabinets

All of the RCA Berkshire Series receivers are made up from the same major components listed above so that the fidelity and performance characteristics are of the same high standard in all models. In keeping with the high technical standards, a number of fine cabinet styles have been designed by leading artists and designers; including William Millington, T. H. Robsjohn-Gibbings, and Edward Wormley (Fig. 4). These are called the "Berkshire" models, from the music festival where they were first introduced.

The five models of the "Berkshire" series are known as the Breakfront, Secretary, Regency, Contemporary, and Modern. Each represents the very finest in cabinet design and artisanship. They are manufactured by Baker Furniture, Inc., of Holland, Michigan, and other furniture makers of the highest reputation. The woods used, the construction, the hand-worked details—all are the finest obtainable. The Breakfront, as designed by William Millington of the Baker Furniture Co., and the Regency as designed by Edward Wormley, are available complete with television. The Secretary, also by Baker Furniture Company, and the Modern and Contemporary versions, designed by T. H. Robsjohn-

Gibbings, incorporate only the radio and phonograph facilities.

In addition to the cabinet models the RCA Consumer Custom Products Department makes available a service whereby its engineers will work with architects, interior designers, and decorators in the design of built-in installations, or special cabinetry. This service provides not only the finest equipment available, but also insures that an effective method for arranging and housing this equipment will be achieved.

The Consumer Custom Products Department

The various models of the Berkshire Series, as mentioned previously, have been planned and are sold by the RCA Consumer Custom Products Department. This is a separate department of the RCA Victor Division with its own staff which is headed by Miss Harriet H. Higginson, one of the country's best known woman merchandisers. Coordination of engineering and manufacturing of the department's products is under the direction of Mr. Carl N. Reifstick, Assistant Manager of the Department. Broadcasters will remember Carl as long-time manager of RCA's broadcast audio engineering and manufacturing activities. Thus, if they see in these fine Berkshire receivers a certain resemblance to RCA's extremely successful line of deluxe broadcast audio equipment, they will not be surprised—it was planned to be that way.

References

- ¹"At last . . . An 'FM Quality' Speaker". G. E. Rand. Broadcast Audio Section. Engineering Products Dept.. BROADCAST NEWS, Vol. 46, September, 1947.
- ²"Audio Noise Reduction Circuits", H. F. Olson. RCA Laboratories, Princeton, N. J., ELECTRONICS, December, 1947.

FIG. 11 (below). These high-quality deluxe receivers take their name from the Berkshire Music Festival where they were first introduced. Shown here is "The Modern", with the Boston Symphony Orchestra.



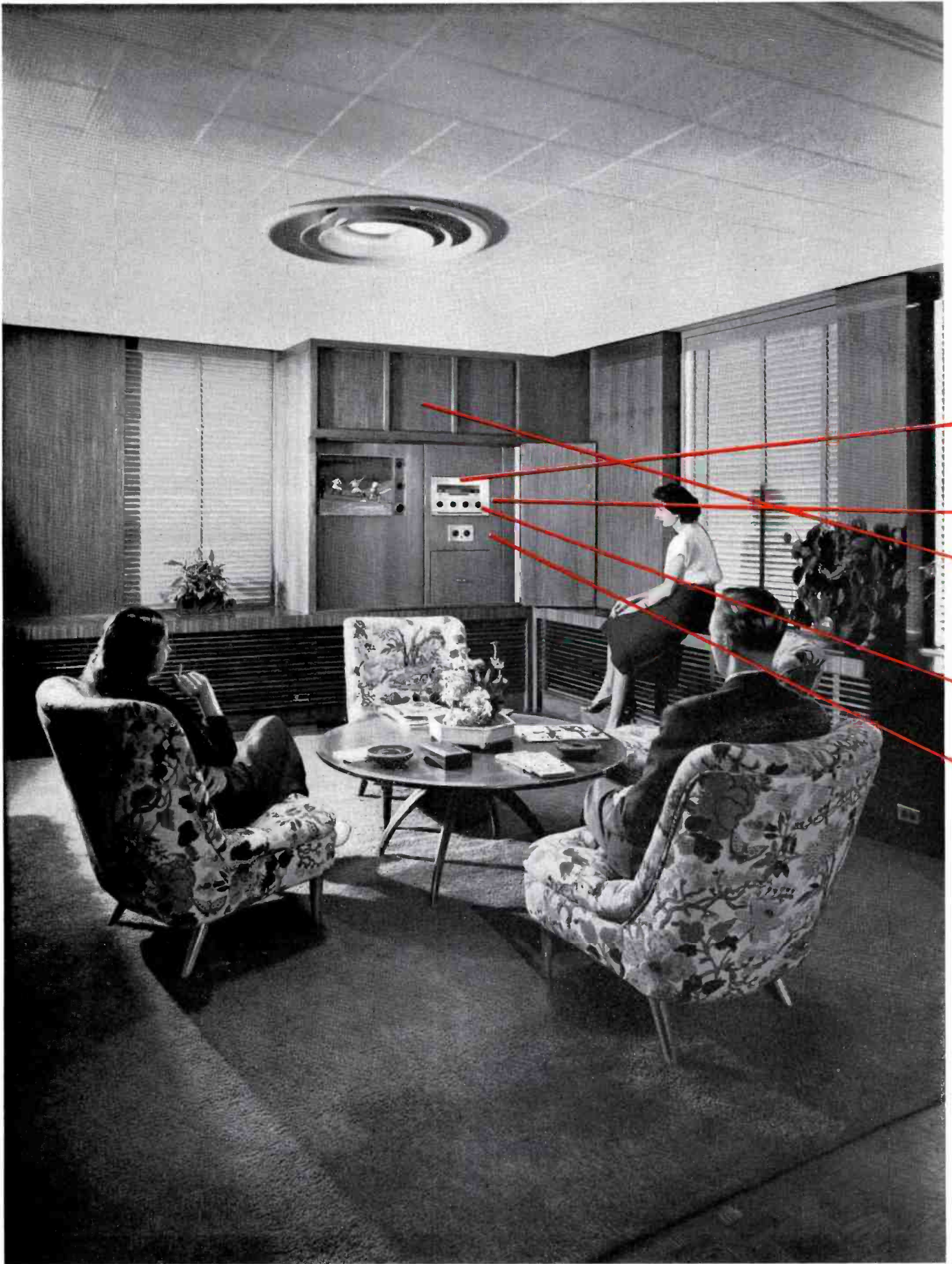

Highest Fidelity from Components of the

RCA VICTOR

Berkshire
SERIES

Aside from the tested and proved excellence of the AM tuning system—basically that of the famous AR-88 Communications Receiver—many new improved technical components appear in the Berkshire Series for the first time. Among them, the RCA Olson speaker, offering smooth frequency response throughout the entire range of from 30 to 15,000 cycles; the amplifier which is more comparable to high fidelity equipment constructed for broadcasting studios than to ordinary home instruments; the noise suppressor providing marked advantages in the suppression of noise, needle scratch and other spurious sounds. Behind the control panel, in the tuner chassis—the autotune unit, permeability tuning system and the tone control gear assembly operate with magnificent precision to deliver the unique performance characteristic of the instruments of the RCA Victor Berkshire Series.

OPPOSITE PAGE: RCA VICTOR BERKSHIRE AND CLUBMAN—large screen custom television—in the office of David Searl, Publisher of Esquire. In this one unit all facilities of the RCA Victor Berkshire Series television, radio, phonograph equipment have been combined. G. McStay Jackson, designer.

BELOW: Closeup of installation shown opposite.

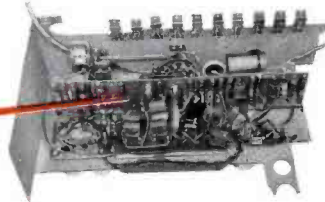
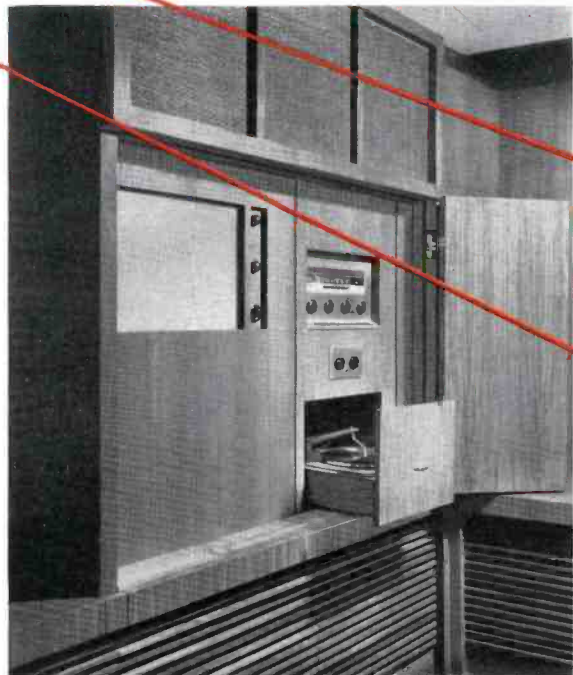

RCA NOISE SUPPRESSOR—effective in elimination of surface noise, needle scratch and other spurious sounds.

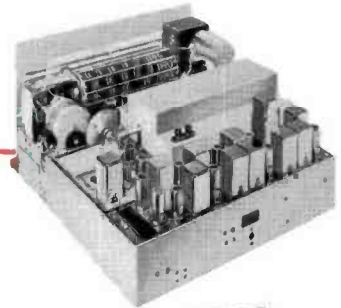

TUNER CHASSIS—meticulously engineered to guarantee superb reception on all services—AM, FM and short-wave.



RCA DUO-CONE DIRECT RADIATOR LOUDSPEAKER—for smooth frequency response throughout entire range of 30 to 15,000 cycles.

CONTROL PANEL—provides complete and automatic control of all functions of the powerful mechanism behind it.

AMPLIFIER—its undistorted output of 35-40 watts provides reserves of power for more faithful operation at all volume levels.

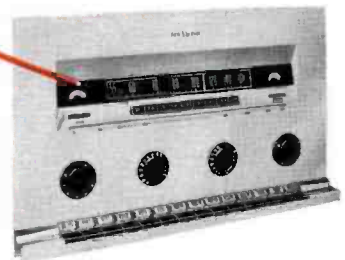

FOR INFORMATION REGARDING CUSTOM EQUIPMENT WRITE:

RCA VICTOR

CONSUMER CUSTOM PRODUCTS DEPT.
745 FIFTH AVENUE, NEW YORK 22, N. Y.

This 250-watt



**From 250 watts
to 1 KW in
one easy step**

**Use the BTA-250L as your
250-watt Transmitter now ...**

READY TO SHIP—America's favorite
250-watt AM transmitter, type BTA-250L

With operating features as familiar to
broadcast engineers as station calls, RCA
250-watt AM transmitters—more than 300
of them—have been making friends with
station men since 1940.

Type BTA-250L includes all of the latest
developments in low-power AM broad-
cast transmitters. It provides economical,
reliable, high-fidelity operation and is
completely self-contained. The BTA-250L
includes a harmonic filter and antenna
matching circuit *built right into the final
stage*. No trouble here with dust in the
tuning circuits—because this transmitter
uses no air capacitors.

AM transmitter can be stepped up to 1 KW

... *simply*



WITH this 250-watt AM transmitter you can go to 500 or 1000 watts... simply by adding on an RCA 1-kw r-f power amplifier. Your BTA-250L then becomes your driver. Not a penny of your original transmitter investment is lost... because in this conversion there are no power tubes to discard or obsolete equipment left on your hands.

How quick and easy is it to convert? *You can make the change to higher power between "sign-off" and "sign-on"!*

This is one reason why the BTA-250L is a "natural" for stations planning a future power increase... or replacement of old equipment.

And there are many other reasons, too. Here is a transmitter that is *bushed* for quiet operation—uses no fans, blowers, or noisy a-c contact controls. It is designed with all controls and switches grouped on one central panel—and within handy reach. It provides an accurate means for logging... because it uses precision-type vernier tuning indicators. And all meters are located at eye-level for convenience of the operator.

For complete information about the BTA-250L... and how you can add an RCA 1-kw power amplifier to it *inexpensively*... call your RCA Broadcast Sales Engineer. Or write Dept. 19LA, RCA Engineering Products, Camden, New Jersey.

... add on this 1-kw Power Amplifier type BTA-1L for high power later

Completely self-contained, this business-like r-f power amplifier makes it practical to go to 500 or 1000 watts—using a BTA-250L as the driver. The center section houses the power equipment. The right section houses the modulator and r-f power amplifier. Ample space makes it easy to reach all components. Type BTA-1L features fewer r-f stages and simpler operations—your assurance of maximum on-air time.



BROADCAST EQUIPMENT

RADIO CORPORATION of AMERICA

ENGINEERING PRODUCTS DEPARTMENT, CAMDEN, N.J.

In Canada: RCA VICTOR Company Limited, Montreal



RCA Velocity
Microphone
Type 44-BX
Effective Output Level, -55 dbm
Hum Pick-up Level, -112 dbm



RCA Polydirectional
Microphone
Type 77-D
Effective Output Level, -57 dbm
Hum Pick-up Level, -126 dbm

Broadcasting's Best...

—now available from stock

These are the network favorites.

Year after year they serve more broadcast and television audiences than any other microphone. Yet, despite their overwhelming popularity, RCA's engineering continues to make both even better than before.

The 44-BX is the bi-directional type—designed for AM, FM, and TV studios where highest quality reproduction is desired. It provides high-fidelity output over the entire audio range—and is free from cavity or diaphragm resonance and pressure doubling.

The 77-D is the polydirectional type . . . quickly adjustable to *any* pick-up pattern you want. A 3-position voice-music switch enables you to select the best operating characteristic for voice and music. *Hum pick-up level, -126 dbm!*

RCA 44-BX and 77-D microphones are yours for immediate delivery. Simply call your RCA Broadcast Sales Engineer. Or write Dept. 19 JB, RCA Engineering Products, Camden, New Jersey.



BROADCAST EQUIPMENT
RADIO CORPORATION of AMERICA
ENGINEERING PRODUCTS DEPARTMENT, CAMDEN, N.J.

In Canada: RCA VICTOR Company Limited, Montreal

RCA Type WX-2B
540-1600 kc.



The new *Portable Field-Intensity Meter*,
RCA Type WX-2—shown one-third actual
size. A loop antenna is built right into the lid!

a truly portable Field-Intensity Meter

• Weighing only 12½ pounds—including batteries, here's a small, compact field-intensity meter of high accuracy that carries around like a portable radio . . . and operates almost as simply. You tune in a signal, adjust a *built-in* calibrating oscillator and receiver gain . . . and read signal intensity directly in *microvolts-per-meter*. No charts, curves, or correction factors to worry about. No computations to make.

Designed with a wide sensitivity range of 10 microvolts/meter to 10 volts/meter, Type WX-2B enables you to make field-strength readings anywhere—from the very shadow of your transmitter, to the toughest location “down-in-the-

noise.” Plenty of front-end selectivity, too. Loop antenna Q is approximately 100 at one megacycle; An r-f amplifier stage provides a very high order of image rejection.

Power supply; Ordinary flashlight dry cells for the quick-heating tube filaments—and a 67-volt battery of the size used in camera-type radios for the B supply.

A lot easier now to get the facts on your coverage, service area, and antenna efficiency . . . with RCA's new portable WX-2B. Ask your RCA Broadcast Sales Engineer for the facts. Or write Department 19-H, RCA Engineering Products, Camden, New Jersey.



BROADCAST EQUIPMENT
RADIO CORPORATION of AMERICA
ENGINEERING PRODUCTS DEPARTMENT, CAMDEN, N. J.

In Canada: RCA VICTOR Company Limited, Montreal

Television's King Pin...



The RCA-8D21 Push-Pull Power Tetrode
used in the famous RCA TT-5A 5-KW Television Transmitter

... an important contribution to television broadcasting

AS REVOLUTIONARY as television itself, the RCA-8D21 push-pull tetrode has set new records for stability, gain per stage, low grid current, linearity, and bandwidth in *more than 50* RCA TT-5A 5-KW Television Transmitters. Used in both picture and sound power amplifiers, the RCA-8D21 employs advanced principles of screening, cooling, and electron optics to offer you these important benefits:

1. Low grid current results in simple, inexpensive modulator.

2. Requires fewer, lower-powered, r-f driver stages.

3. Allows modulation in the output stage.

4. Requires only one broad-band r-f circuit in entire transmitter (between tube and antenna transmission line).

5. No critical linear amplifier stages are required.

6. Better picture quality—output-stage

modulation results in low distortion and phase shift.

7. Efficiency of tube permits use of simplified, economical power supply.

For your convenience, RCA tubes are available from your local RCA Tube Distributor or directly from RCA. For information on any RCA tube, write RCA, Commercial Engineering, Section 36-BP, Harrison, New Jersey.



The world's most modern tube plant...

RCA, LANCASTER, PA.

THE FOUNTAINHEAD OF MODERN TUBE DEVELOPMENT IS RCA



TUBE DEPARTMENT

RADIO CORPORATION of AMERICA

HARRISON, N. J.