

# BROADCAST NEWS

KAKE



VOL. No. 102 OCTOBER 1958



# new RCA magnetic disc recorder

combines advantages  
of tape and disc!

A great new tool for broadcasters... makes  
possible fast recording  
and playback of  
commercials  
and announcements



**The Magnetic Disc—**  
extremely rugged, not easily damaged, and with a life expectancy equal to or greater than tape. Information already recorded can be erased easily, permitting re-use of disc.

Type BQ-51A/BA-51A  
Magnetic Disc Recorder and  
Recording Amplifier

This new Disc Recorder, a completely self-contained unit, meets the broadcaster's requirements for fast recording and playback of commercials and announcements. Extremely simple in operation, it minimizes the skill required to produce a professional recording. Grooves for recording are molded into the blank disc. No cutting mechanisms, optical devices and heated styli are needed; the same equipment serves for recording and playback. All of the advantages of magnetic tape recording are retained in the magnetic discs, yet winding, splicing, cuing and other tape handling problems are eliminated.

A recording time of 70 seconds is obtained from each side of the magnetic disc, which includes 10 seconds for "cue-in" and "trip-out" cue tones. The magnetic discs are recorded at 33 1/2 rpm.

The magnetic head used in the system consists of two C-shaped laminations made of a material that is extremely hard physically, but with very high permeability. A newly designed tone arm which accommodates standard MI-11874-4 (1 mil) and 11874-5 (2.5 mil) pickups also can be handled by means of a plug-in socket arrangement. It can be used for reproducing standard transcriptions and phonograph records up to 12 inches in diameter at 33 1/2 or 45 rpm.

**Magnetic Recording Head.**  
The magnetic pole pieces which do the recording protrude through the narrow slot (see arrow).



*The Magnetic Disc Recorder can be the first of the building blocks in preparing for automatic programming. For complete information on the Disc Recorder and companion units call your RCA Broadcast Representative. In Canada: RCA VICTOR Company Limited, Montreal.*



**RADIO CORPORATION of AMERICA**

BROADCAST AND TELEVISION EQUIPMENT

CAMDEN, NEW JERSEY

Vol. No. 102

October, 1958

# BROADCAST NEWS

*published by*

**RADIO CORPORATION OF AMERICA**  
BROADCAST & TELEVISION EQUIPMENT DIVISION  
CAMDEN, NEW JERSEY

*issued quarterly*

**PRICE** *in U.S.A. - - - - \$4.00 for 4 issues*  
*outside U.S.A. - - - \$5.00 for 4 issues*

## C O N T E N T S

|  | Page |
|--|------|
| WBTV REPORTS ON RCA COLOR VIDEO TAPE RECORDER . . . . .  | 2    |
| UNIQUE AUDIO INSTALLATIONS AT WCSH AND WCSH-TV . . . . .   | 4    |
| THE DAY THEY MADE ALASKA A STATE . . . . .   | 8    |
| KAKE-TV EMPHASIZES FUNCTIONAL ARRANGEMENTS<br>FOR BROADCASTING . . . . .   | 12   |
| U. S. ARMY SOUTHEASTERN SIGNAL SCHOOL FINDS EDUCATIONAL<br>TV HAS IMPORTANT PLACE IN MILITARY TRAINING . . . . . | 24   |
| C. H. COLLEDGE APPOINTED GENERAL MANAGER,<br>BROADCAST AND TELEVISION EQUIPMENT DIVISION . . . . .               | 27   |
| 500-WATT TV TRANSMITTER AMPLIFIER, TYPE TTL-500AL/AH . . . . .   | 28   |
| ADAPTING RCA 16-MM TELEVISION FILM PROJECTORS<br>FOR MAGNETIC REPRODUCTION OF SOUND . . . . .                    | 30   |
| REMOTE CONTROL OF THE 50-KW AM "AMPLIPHASE" TRANSMITTER . . . . .  | 34   |
| NEW FM AND MULTIPLEX EQUIPMENT . . . . .   | 38   |
| INTRODUCTION TO JUNCTION TRANSISTORS, PART I . . . . .   | 45   |
| THE RCA TEST FACILITIES FOR TV ANTENNAS . . . . .  | 54   |
| UNIVERSITY OF MICHIGAN BEGINS MEDICAL INSTRUCTION<br>WITH RCA EQUIPMENT . . . . .                                | 60   |



FIG. 1. Recording the "Betty Feezor Show," first full color program to be recorded and played back by a television station. Engineer at controls is Dallas Townsend.



## WBTV REPORTS ON RCA COLOR VIDEO TAPE RECORDER

*Finds New Features Make Possible New Operating Convenience, Save Time and Expense*

On September 5, 1958, WBTV became the first television station to record and air a full color video tape recording. Since that time the station has gathered considerable operating experience in using the RCA color video tape recorder. In a recent letter (the text of which follows) Tom Howard, WBTV Vice-President of Engineering and General Services, reports on the operational success of the equipment.

"The color video tape recorder was assembled and installed by WBTV technicians. Installation and the wiring of the unit into the station's power, video and audio systems began on the morning of September 1 and was completed on September 2. Jerry Lindner, the RCA engineer, arrived on the morning of September 3 to check out the system; and the first monochrome pictures were recorded and played back that same day. On September 4 the color system was checked out and successful test color recordings were made and played back. At 11 A.M., the following morning (September 5) a local live production, the 'Betty Feezor Show,' was taped in color from Studio 2 and played back on-the-air at 1:00 P.M., to establish another WBTV first.

### Time Saving Features

"Monochrome and color pictures as recorded and reproduced by the RCA color video tape recorder are superb and we are impressed by the conveniences and versatility designed into the equipment. It is evident that RCA's design engineers did not limit their efforts to just getting video and audio signals on tape—they remembered that their customers had to maintain and operate the gear day-in and day-out. We like the rack mounted design because it is convenient to install and because components are visible and accessible from the front or back at all times—even when the recorder is in use. We like the master erase head. It eliminates the necessity for bulk-erasing, assures a *clean* tape at all times and allows for *selective* erasing and re-recording of spots or other program material without destroying the other contents of the reel. It is a time-saver. For instance, if there has been a false start or a fluff in a spot or in the early part of a recording, it is only necessary to back the tape up and start over again. There is no need to remove the reel, bulk erase, replace the reel and start over again.

### Built-in Facilities Simplify Operation

"We commend the decision of the RCA design engineers that *necessary* operational equipment should be *built-in* the recorder instead of being made available as 'accessories.' We appreciate their facing the facts of 'operational-life' by incorporating the master erase head, the built-in audio monitoring speaker for cuing and continuity, the built-in picture monitor, the built-in CRO, the built-in switcher for picture monitor and CRO input signal selection, the elapsed time meter for slip rings and brushes, the built-in head degausser for video heads, the metering of individual video head recording currents, the provision of continuously adjustable tape wind and rewind speeds for rapid and accurate cuing of tape, and the built-in test signal channel for rapid check and trimming of color processing equipment, even while a color signal is being recorded.

### Cue Track a "Must"

"Most of all, we love that cue track—in our opinion it is destined to be a 'must' in every tape operation. While the value of the cue track seems to be limited only by the imagination and ingenuity of the

user, we decided to learn to 'walk' with it before we attempted to 'run.'

#### How Cue Track Is Used

"When a program is to be recorded, a microphone feeding directly to the cue track is used to put the program identification, spot name and number, and recording date plus a count-down from 10 to 1 on the tape, and ending up with the word 'cue.' The tape is rewound to the original starting point and then started in playback. The machine is stopped immediately upon hearing the word 'cue' and is set up for recording a program. Exactly 30 seconds before the program is to begin, the machine is rolled, taking black picture and no sound from the studio. At program time the director comes up from black and the program is started and run to completion, at which time the director goes to black, kills sound, and we continue to record black picture for 30 seconds longer to provide a 'pad.' During the recording of the program the cue track is bridged across the director's inter-com and all of the cues and comment during the program are recorded.

"On playback, it is only necessary to monitor the cue track on fast forward or reverse to find the characteristic sound of count-down. The tape is stopped and then played back at normal speed while it identifies itself—counts down and tells us to stop. Exactly 30 seconds before air time, the machine is started and black picture comes up allowing the operator 30 seconds time in which to check tracking

and adjust video head penetration before the video is switched to air. During the time the program is on the air, the director, the video switcher, the video operator and the recorder operator hear all of the director's cues and instructions (recorded during the live show) from the cue track. This feature has allowed us to salvage some 'fluffed' spots in the program or to insert new spots—live or on film—in a program that has already been recorded.

#### Plans for Automation

"We are now experimenting with other and more intriguing uses of the cue track, planning to investigate the feasibility of incorporating a 'search and control' system to find and cue any predetermined location on the tape. RCA's pioneering in incorporating the cue track in video tape recorders is a valuable contribution to smoother tape operation and definitely opens another avenue to automation."



FIG. 2. Frank Bateman, Technical Operations Manager (right), points out the cue track recording head to WBTV executives—l. to r.: Charles H. Crutchfield, Executive Vice-President, Jefferson Standard Broadcasting Company; Kenneth Tredwell, Vice-President and Managing Director WBTV; and Tom Howard, Vice-President, Engineering and General Services, Jefferson Standard Broadcasting Co.

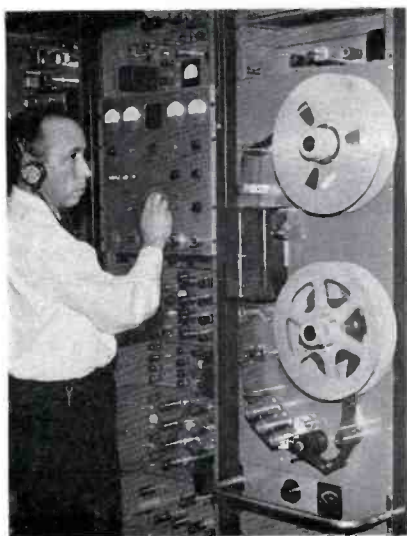

FIG. 3. Robert L. Dycus, Maintenance Crew Chief, monitors the recorder cue track.

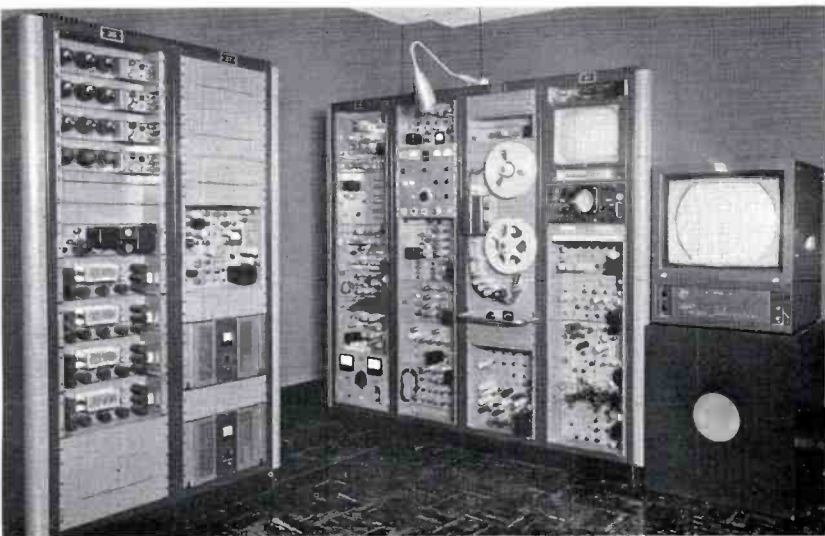

FIG. 4. The RCA Color Video Tape Recorder is shown in a corner of the WBTV telecine room. This area was reserved for video tape as a part of the station's plans for full color operation.



# UNIQUE AUDIO INSTALLATIONS AT WCSH AND WCSH-TV

*Skillful Use of Standard Equipment Items and Design of Novel Remote Audio Unit Enables These Stations to Keep Abreast of Today's Program Requirements with Despatch and Efficiency*

by C. R. BROWN,\* *Technical Director, Stations WCSH and WCSH-TV, Portland, Maine*

Station WCSH, Portland, Maine, has made its audio operations in both AM and TV more flexible by *customizing* standard equipment to meet specific programming needs. For its AM operations, WCSH built a unique remote unit that provides control facilities equal to those of a studio at any remote location. Furthermore, audio control at WCSH-TV has been combined into one central location, achieving one-man operation during network and film periods.

## Portable Remote Unit Makes Radio Broadcasts a Professional Presentation

Like most stations, WCSH has realized the promotional value of remote broadcasts. Equipment for remote broadcasts, however, can grow out of proportion, and many unnecessary problems can be introduced. The average remote requires the following equipment: remote amplifier, public-address amplifier, portable turn-

table, microphones, cables, loudspeakers, headphones, ac cords and tools. Transporting all of this cumbersome equipment is an annoyance for personnel. There are times when portions of a remote broadcast, such as records, can be played at the studio; however, with disc-jockey shows this becomes very complicated, thus impractical. Troubles often develop from hurriedly assembling all of this remote equipment—hum and even complete failure are not uncommon. These factors all contribute to make general remote performance unsatisfactory; therefore, something had to be done at WCSH.

### One "Box" for Remotes

The first step was to determine what constituted the practical size and weight for a single unit remote setup. Announcers and engineers discussed this with the following results: A single unit that could easily be carried by two men and placed in a car was the general size agreed upon. Other physical limits were left up to the engineers building the unit. It was further decided to use separate loudspeaker enclosures, in order to get good reproduction quality, which meant, two additional enclosures (see Fig. 1).

### Equipment for Remotes

One "box" contains all remote equipment (see Fig. 2). A 50-watt public-address amplifier is mounted under the two turntables, and the input of the p.a. amplifier is bridged across the output of the BN-6A Remote Amplifier. In the bottom of the "box" a drawer was built to carry microphones, cables, headphones, and tools commonly needed. Permanent connection of equipment eliminates haywire setup that occurs when equipments are separate.

\* The author wishes to thank and to acknowledge the assistance of Roland Desjardins, studio supervisor, and Vincent Chandler, transmitter supervisor, for their contributions in planning and construction of both units.

FIG. 1. This is the remote setup used by WCSH. The BN-6A Remote Amplifier, two turntables, and a public-address amplifier are in the large "box," on wheels which also serves as console desk for d-j. Two separate speaker enclosures are shown at the right.



### The Remote Amplifier

Size, weight, and versatility were the major determining factors in selecting a remote amplifier. Considering all of these factors WCSH chose the BN-6A Transistorized Remote Amplifier. It met the exact requirements of this setup. Two channels are required for the turntables, the third channel for the announcer's microphone, and the fourth channel for a roving microphone (or other input such as a tape recorder). Channel switching and audible cuing were not required, thus the BN-6A required no modifications.

The BN-6A Amplifier is mounted on a drop leaf (see Figs. 3 and 3A) which also serves as the announcer's desk. When moving the "box", the leaf can be lowered out of the way. Clips screwed into the hinged leaf are used to mount the BN-6A, so that it can be easily removed for other uses. A station banner was attached to the front edge of the drop leaf, and it is used to conceal the operator's legs while at the same time decorating the installation (see Fig. 2).

FIG. 3. The BN-6A Remote Amplifier is easily dropped into this position when moving the remote setup.



FIG. 2. Here is a typical WCSH remote setup. Utility and appearance of this setup enhance the station's prestige.

### Easy to Set Up

The WCSH remote unit is not only portable, but very easy to put into operation. Connection to the telephone lines requires only a screw driver; all other connections are made with plugs. One ac connection serves the entire unit. Loudspeakers are connected with Jones plugs. This type of simple connection permits rapid set up; all wiring is permanent, thus hay-wire connections are completely eliminated.

### Practical Portability

The WCSH remote unit has not been restricted to air work. Many of the WCSH disc jockeys conduct record hops which get just as complicated as a d-j show, and they have been using this remote amplifier with great success. The remote unit can also be used by the studio for recording purposes. The many possible uses for this unit makes it an attractive investment, moreover it combines utility with good appearance to enhance a station's prestige.

FIG. 3A. The BN-6A is raised into this position and supported by a pipe leg when the remote is set up.

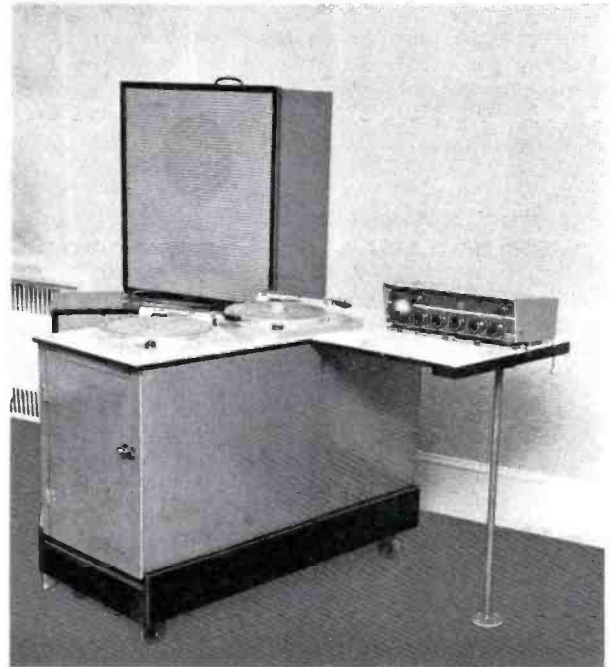





FIG. 4. Three consolettes are shown at the single operating position in the WCSH-TV control room. The BC-6A Consolette controls network, film and tape facilities, in addition to controlling the outputs of the two BC-5B Consolettes.



FIG. 5. One-man operation is illustrated here. During network and film periods the necessary audio and video controls are all within the reach of one operator.

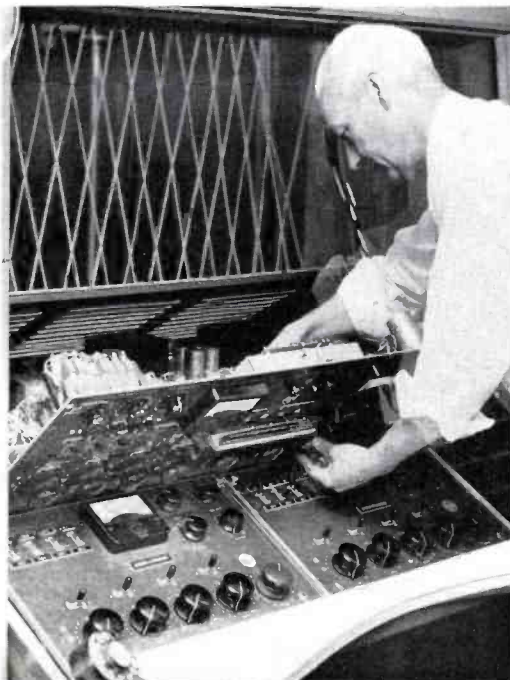

FIG. 6. The front panel of the BC-6A is tilted out for ease of tube replacement and maintenance. This can be done while unit is on air provided the proper precautions are taken.

## Customized Audio Control During TV Network

Two studios and one announce booth at WCSH-TV are controlled from one central location by combining a BC-6A Consolette with two BC-5B Consolettes (see Fig 4). All network and film audio controls have been placed within easy reach of the video operator, thus during network and film periods one man is able to control both audio and video (see Fig. 5).

### The Announce Booth

Two turntables and a microphone in the booth are controlled by the announcer. The output of the announce booth consists of one audio pair which is fed directly into the BC-6A Consolette. The output level of this booth can be preset before air time, and this can reduce the audio operator's chores during live studio originations.

### Two Live Studios

A separate BC-5B Consolette is used for each of the two live studios, with eight microphone inputs on each consolette. The output of each BC-5B is separately fed into the BC-6A Consolette. The BC-6A controls the output level of each BC-5B, and this permits a high degree of preset microphone operation.

### Other Audio Facilities

Network and remote lines, two film projectors, and two tape recorders are fed directly into the BC-6A Consolette. Since these controls would be used more during network and film operations, they were brought out on the right side of the BC-6A, within easy reach of the video operator. This makes a one-man operation feasible (see Fig. 5).

### Servicing of Audio Console

The BC-6A is tilted up, as usual, for maintenance; however, the top lid of the mounting board is also hinged so that it swings up with the consolette to simplify servicing and tube replacement (see Fig. 6).

Wiring on the BC-5B Consolettes was made long enough to permit sliding the units up and out of the audio table for easy servicing (see Figs. 7 and 8). Holes bored in the sides and back of the table provide adequate cooling without using blowers.



## Permits One-Man Operation and Film Broadcasts

### Central Control

At WCSH-TV all audio control is grouped in one convenient location (see Fig. 9). This aids operators during live and remote operations by making all controls easy to reach. If WCSH-TV were to add an additional studio in the future, another BC-5B Consolelette would simply be added to the present system, and the same could hold true if film operations were expanded.

### Customizing Standard Equipment

Today's fast pace radio and TV programming demands the most of equipment as well as ingenuity of engineers. Most stations have applications where special equipment is desirable, but if cost prohibits this, the techniques used by WCSH could well be imitated.

FIG. 8. Wiring of the BC-5B was made long enough to permit lifting the consolettes onto the table, as shown here, for greater accessibility.

FIG. 9. This is an over-all view of the WCSH-TV control room. Audio facilities are conveniently grouped on the left.

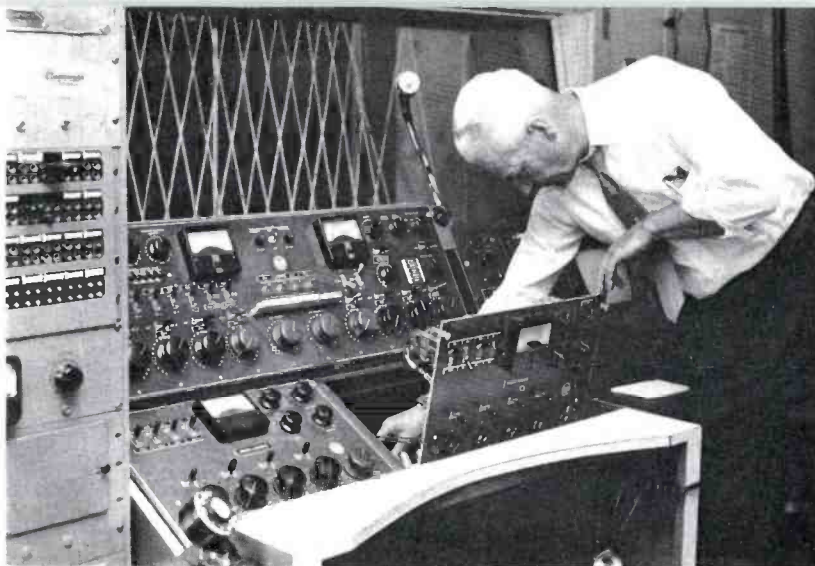
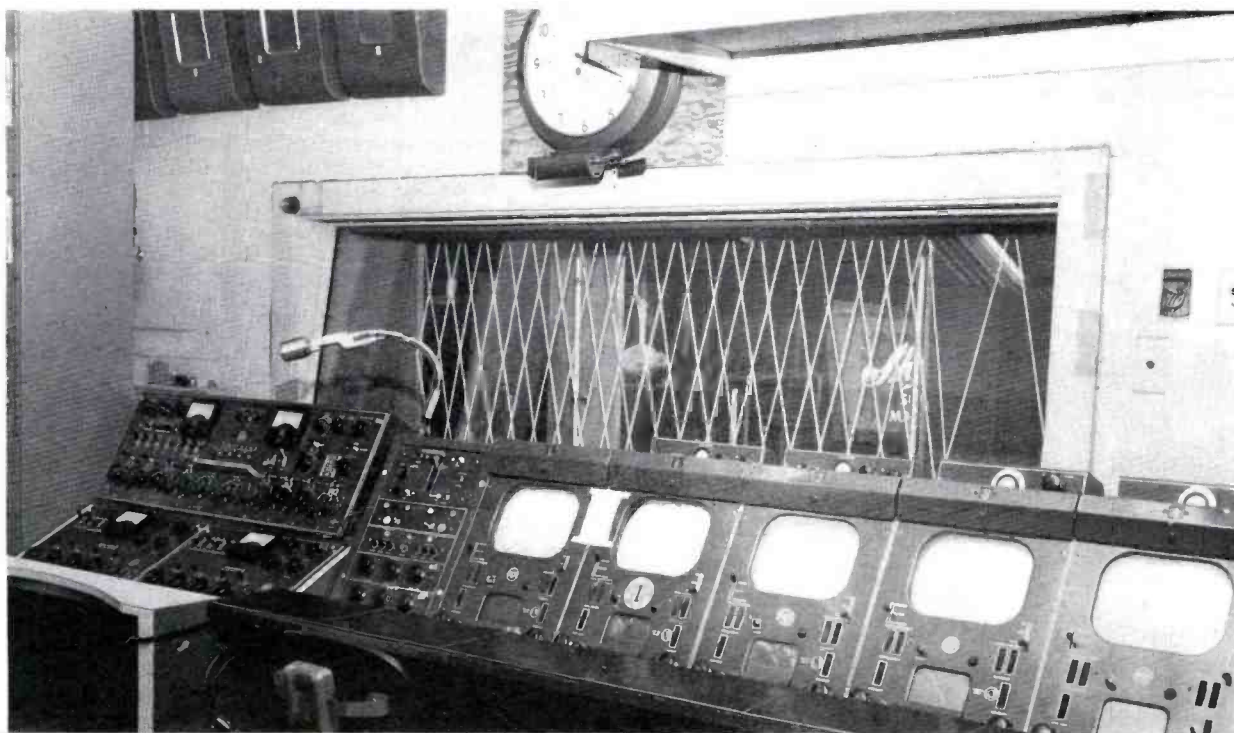

FIG. 7. The BC-5B Consolettes can be serviced by lifting up the front panel as shown here (or as shown in Fig. 8).





# The day they made

Midnight Sun Broadcasting Company Uses RCA Television Equipment

by LAURA HENDRICKS, Commentator and Engineer, Station KENI-TV, Anchorage, Alaska



FIG. 1. All the exciting events that took place in Anchorage, Alaska, on that historic day of statehood, were put on air, live and through film, by KENI-TV on Channel 2.

The plans of the Midnight Sun Broadcasting Company had all been set. Each member of the staff knew exactly what they'd do if and when it was announced that Alaska had been voted the 49th State.

As the NBC outlet in Anchorage, Alaska's biggest city, we realized that when the news became known we'd be right in the center of the year's hottest story. The only trouble was that none of us really believed that it would happen.

For years the area residents, those in town and in the "bush," have relied on KENI radio for fast, accurate reporting of the news. Operating on 5000 watts, on 550 kc, our radio station reaches many places that are not inaccessible by road. In fact, the operation of our "Mukluk Telegraph" is an exciting story in itself.

The Midnight Sun Broadcasting Company was born of Alaska's bounty and

maintains itself as a service to Alaskans everywhere. So, in anticipation of covering Alaska's biggest story the facilities of our radio and television stations were geared for instant action. We called it OPERATION 49.

As the days wore on, and while they argued in Congress, we listened to each newscast with increasing interest and hope. The statehood fever seemed to erupt all over Anchorage, and old-time statehooders who had so often been bitterly disappointed, were suddenly confident that this would be remembered as the year in which Alaska gained its full stature as the country's largest state.

In our setup, radio station KENI, is located on the fourth floor of the Lathrop Building. The studios are grand in the original manner of radio stations. The lobby is paneled with mahogany and with

ceiling-to-floor mirrors. Studio A, a "floating" studio, is also paneled with the same fine wood. It is acoustically beautiful, has an elevated stage, and is directly under the eye of the upstairs control room.

Our television equipment is in the basement of the Lathrop Building—which, incidentally, is surprisingly spacious. Our equipment is RCA throughout. We operate with one studio camera. Behind it we have the best photographer in Alaska. James Balog covers us pictorially for both news and studio work. Jim has photographed stories all over the world and has found in Alaska the type of living and excitement that he desires.

Excitement lay just under the surface the morning of June 30th. I went about my work in the film library during the morning, one ear cocked for our early bird, Scotty McCulloch. He mentioned several times that a definite answer to the



# ALASKA a STATE!

to Cover Anything from Statehood to the Annual 3-Day Dog Races



FIG. 2. The gigantic fire in which 49 tons of wood went up in smoke was a signal to the world that Alaska has been granted statehood.

obstacles that stood in the way of statehood would not be forthcoming for two days.

Well, that suited me fine. Though I work on my first-class ticket two hours each day, the main body of work involves handling the vast amount of film which we use in our programming each week. On Mondays, I'm busy enough as it is just taking care of the shipping and editing.

However, during the past week, as our anticipation of the impending story rose, I had been turning on the transmitter each morning, though our regular sign-on is not until 3:30 p.m. But, just in case the story broke, I wanted to be ready.

Suddenly at 2 p.m., our afternoon announcer, Allen Walters, cut into a record with "The Senate has called for a vote on the third and only remaining obstacle in the way of statehood."

I reacted as though I had been buzzed by one of our speedy Air Force Sabers. First, I ran into the control room and turned on the filaments and other transmitting equipment. Then I ran into my boss' office and before I could utter a word, Allen announced that a vote had been taken . . . and we were in!

I cannot tell you the impact this news had. All Alaska shuddered as though awakening from a long dream. Reality was almost unbelievable after all of these years. Within five seconds, we were on OPERATION 49.

I, as the only engineering staff member present in the studio at the time of the announcement, turned on the plates; took a careful, fast look at the meters. As usual, our RCA equipment operated in normal fashion. Our Chief Engineer, Charles Gray, was in Ketchikan setting

up a new radio station for Midnight Sun. So, I put in a fast call to David Washburn, an electronics technician. David is studying the RCA correspondence course in electronics, and under the guidance of Mr. Gray is developing into a fine engineer.

Though David and I both have our first-class tickets, David does 90 percent of the engineering during our joint tour of duty each day.

"David," I cried. "Come on." and he did. No questions asked. He knew that a big story had broken and that we were operating on 49.

I was lucky to have gotten my call through to him, for the phones were immediately swamped. My phone cut out as I tried to call our part-time engineers from Elmendorf Air Force Base. They have a special prefix to their numbers and even



FIG. 3. James Balog, KENI-TV cameraman, trains the camera on Laura Hendricks, commentator and engineer, during KENI-TV's exciting live coverage of the Alaska statehood celebration.



FIG. 4. Al Bramstedt, General Manager of Midnight Sun Broadcasting Company, and Bill Stewart, Sales Manager for KENI-TV at Fourth Avenue in crowded Anchorage, the day that statehood was announced.

under normal circumstances, it is difficult to reach them. Now, impossible. Then every one of us had our jobs, as we moved into OPERATION 49. Gerry Hinchee, Program Director, stayed on her phone to contact all needed crew members. Pat Uecker, got together all the commercial material needed for our planned broadcast.

The show had been sold by Bill Stewart, our Sales Manager (in anticipation of there ever being a show). Neil Harmon, general assistant and propman, gathered up necessary martial music for us to use in television as we bridged the gap from going on the air to having our cameras in position on Fourth Avenue.

General Manager, Alvin O. Bramstedt, came in with a sheath of AP news in his hand. We were on the air with music and slides. I faded the beautiful words of The Alaskan Flag, threw him a cue, and he made the momentous announcement, that Alaska had just been made a state.

Mr. Bramstedt, who started his career with the Midnight Sun Broadcasting Company as a newscaster in Alaska's first radio station, KFAR, was visibly impressed with the portentous quality of the news he was reading now. He remained in the announce booth reading releases that began to pour in on the wire. We cut away to patriotic music whenever the supply of news failed to keep up with him. There was a constant stream of staff members running up to the fourth floor to get the news from our AP machine.

In the meantime, James Balog, our photographer, arrived at full speed. He and David wrestled our camera and equipment up onto Fourth Avenue. We are located right across from the Federal Building, and by the time the camera was in place, the Elk's flag, 40 by 60 feet,

had been lowered from the upper window and draped the entire front of the building.

While all this was going on in television, KENI radio also went into OPERATION 49. They had two mobile units out in the streets talking to people representing every facet of Alaskan life. Scotty McCulloch and the radio station manager, James Lawson, manned the remote radios. Allen Walters stayed in the control room switching from one remote to another.

Within 20 minutes after the initial announcement that Alaska was "In" KENI-TV was on the air, live, from Fourth Avenue. And Fourth Avenue was the scene and focal point for the entire afternoon's festivities.

Al Bramstedt and our News Director, Ty Clark, handled many of the interviews of the day. They talked to many Alaskans, all seemingly in favor of statehood. Our regular programming was due to start at 4:45 p.m. with one of my own shows, Living Alaska. Early that morning I had called Colonel "Muktuk" Marston and asked him to be a guest. He is one of the spearheads of the statehood movement, so I felt that I had a real scoop in having him for my show on the day that statehood was achieved. We did all of our programming from the street. Bill Stewart who had done hours of interviewing himself, rounded up various other dignitaries for me to talk to during my show segment.

Fourth Avenue was crowded with excited citizens, there were parades, shouting, firecrackers (some right under our feet during the broadcasts) and a wild anticipation of the night's celebration. This was D-Day, VJ-Day, the end of the war and New Year's Eve all rolled into one excited mass of humanity. The activity behind the scene was gigantic. Al Bram-

stedt and Ty Clark were suddenly in demand from New York, California and points east, south and west! They made 15 feeds to the networks and to large independent stations who suddenly realized that things were hotter in Alaska than they were in Cuba!

We stayed live in the street, cutting away to filmed programs whenever necessary. That night, the long-planned fire of 49 tons of wood was put to the torch. This inspiring scene was filmed and on the air two hours after the event took place.

This film showed the crowd of 10 to 12 thousand people who converged on Anchorage to see the fire and to share in the excitement of the celebration. There were mounted horsemen and women who rode round and round the fire; bands from various military installations; prayers were offered and speeches made by the happy workers for statehood. The mood was exultant. The sober realization to the magnitude of the statehood task was yet to come.

When the camera was finally brought back into the studio, and tired crew members went home, Anchorage was still celebrating. But all of us at KENI and KENI-TV were awed with the realization that we had been in the center of the nation's top story. Yesterday we had been part of a network in the "Frozen North." We were very far away and probably lived in igloos. But today, the world knew that this vast and beautiful land of Alaska was important enough to have been made a state. In fact, all of a sudden, we worked for the biggest radio and TV network in the biggest state in the Union. We had been lucky enough to see it happen and it had been our glorious duty not only to tell the people of Alaska the good news, but to tell the world about Alaska, the 49th State!



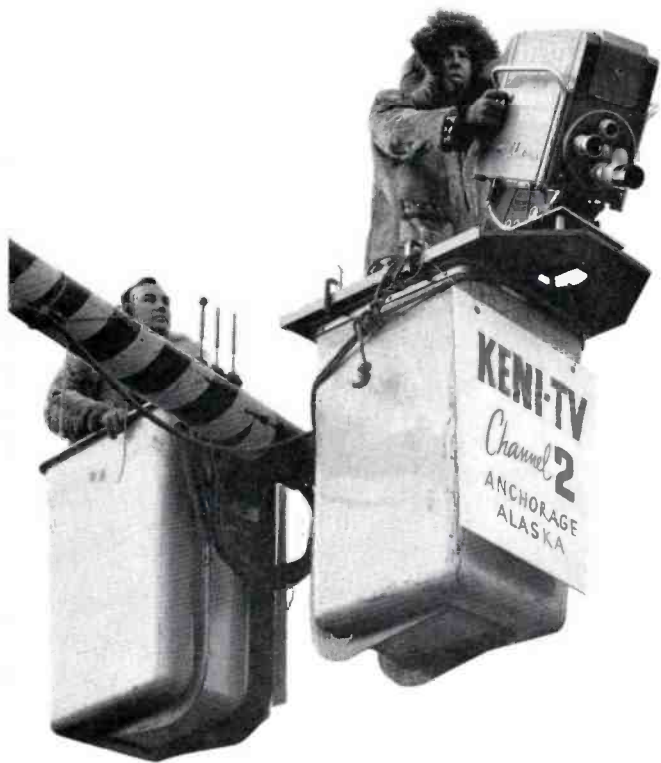

## Annual 3-Day Dog Race

Each year, in February, we have the annual Fur Rendezvous which involves a big 3-day dog race with 20 or more teams starting a 20-mile heat each of 3 days from in front of City Hall in our town. Our TV and radio facilities cover this event with two television cameras and also on radio with five or six check points along the trail.

*(Cameraman in bucket, at left, is Charles Gray, Chief Engineer, KENI-TV)*



# KAKE-TV EMPHASIZES FUNCTIONAL ARRANGEMENTS FOR BROADCASTING

*Station Combines Latest Advances in TV Building Design with Excellent Equipment Arrangements to Provide Top Production Facilities*

by HAROLD H. NEWBY\* *Vice-President in Charge of Engineering KAKE-TV, Inc., Wichita, Kansas*



FIG. 1. Attractive trilevel building houses studios and business offices of KAKE.

Although KAKE-TV was the third television station to go on the air in the Wichita, Kansas, area we have been able to establish a unique position in our market. There are several reasons for this and these form the core of our story. In the words of our vice-president and general manager, Martin Umansky, it goes like this: "As a result of competition, networks tend to equalize one another, therefore, the station that does the best job locally

will have the best chance for success." To us this means not only having a talented staff, full of local programming ideas but, of equal importance, having the facilities with which to do the best job.

#### Unique Features of KAKE-TV

Our physical plant consists of an attractive and functional trilevel building, featuring outdoor as well as indoor studios. Situated on a small knoll, the building

permits ground level loading at a dock leading directly to storage room and studios. All TV equipment is RCA, which we believe is the finest available.

We have designed our facilities to include such features as: three TV switching centers, kine recording, 8-mm film projection, and our own processing of movie film. Switching facilities are extensive because our very heavy schedule of local-live, back-to-back programming requires opportunity for rehearsal during "On-Air" time; also because we do some network origination and switching, in addition to producing some local kinescope recordings. Often these various and independent program switching requirements are simultaneous.

#### On-Air, October, 1954

KAKE-TV is principally owned by local Wichita men with diversified business interests. The station, an ABC affiliate, operates on Channel 10 with 316-kw of visual power and 219-kw aural power. From "scratch" to "On-Air" with completed permanent transmitter building, 1079-foot antenna-tower, and maximum 316-kw power was accomplished in 100 days.



FIG. 2. Leonard H. Goldenson, President American Broadcasting-Paramount Theatres, Inc., (second from left) seen with KAKE-TV executives during a tour of Channel 10's new studios. Left to right in photo are: Ted Gore, KAKE-TV vice-president; Leonard H. Goldenson; Mark Adams, president; Charles Jones, assistant secretary-treasurer; and Martin Umansky, general manager.

\* Assisting in the preparation of this manuscript were the following staff members of KAKE: Keith Griggs, TV Studio Engineering Supervisor; Paul Threlfall, Manager of Radio-TV News and Photo; Claude Clevenger, TV Transmitter Engineering Supervisor; and Gene Courtney, Chief Engineer for KAKE Radio.



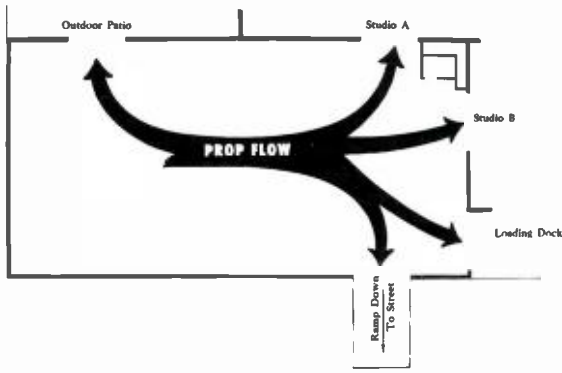

FIG. 3. Diagram showing prop flow chart.



FIG. 4. Basic layout of KAKE building.

Since it was impossible to build a permanent studio building of the magnitude that we envisioned, in the time at our disposal, we procured a temporary prefab metal structure which was used from October of 1954 until May of 1955.

#### Choosing Studio Location

An 8-acre tract of land away from downtown was chosen for the permanent studio site. Only ten minutes from the central business district and twelve from our municipal airport, it is near a paved highway running to the transmitter location, 12 miles away. The area has a bountiful supply of good water, a prerequisite to photo and film processing, adequate air conditioning, and landscaping.

We avoided the congestion, high noise level, and parking problems of a downtown location and have unlimited space for expansion. This location also allowed a shorter and better microwave program path to the transmitter, across relatively flat rural farming country with no tall buildings or other obstacles to impair our program transmission. The location is ideal for microwave paths to and from the local telephone company and the A.T.&T. for remote and network circuits.

#### Precast Construction

The building is of concrete and masonry construction with steel framework and colored porcelain panels for the facade. French glass, together with open stairs, gives a bright and airy feeling. Native stone enhances the appearance in appropriate places.

Walls, both inner and outer, are nonload bearing. The supporting structure consists of steel "I" beams, positioned vertically.



FIG. 5. Building is constructed of precast cement panels.

FIG. 6. Shell of KAKE building showing use of "tilt-up" construction.

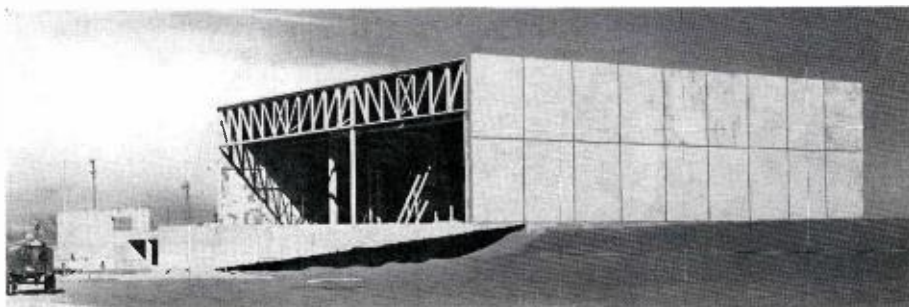

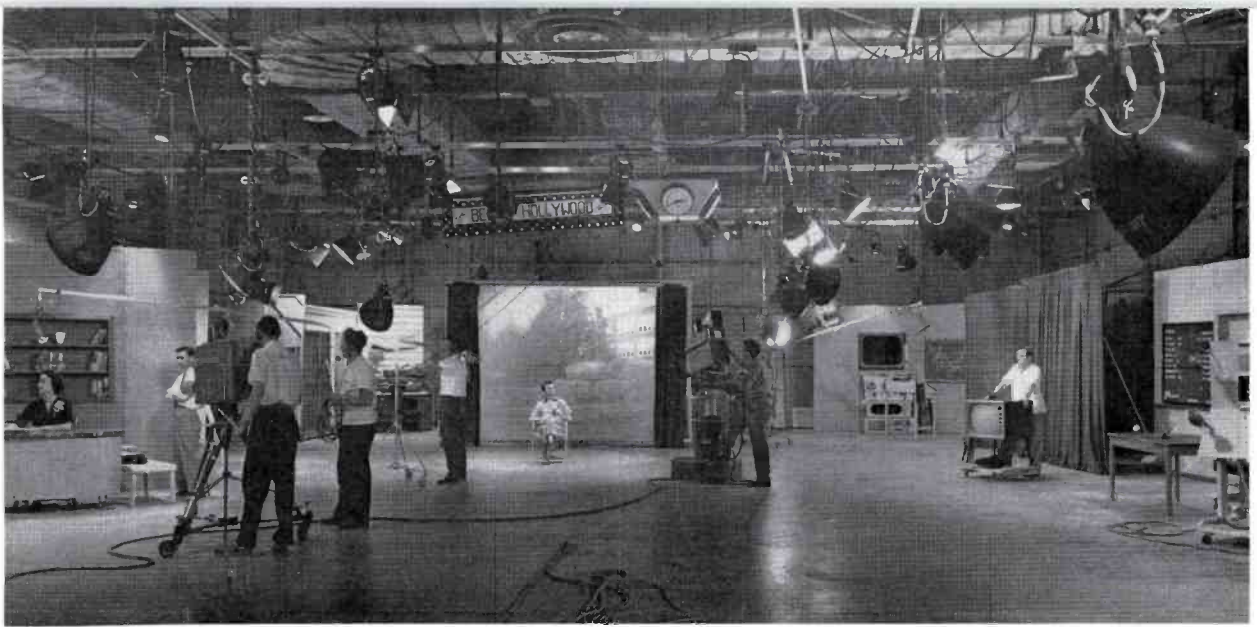

FIG. 7. Studio A, 80 by 60 feet, has drive-in door leading to prop room, to loading dock, and to drive-in ramp. Note complete and modern broadcast facilities.

This type construction makes it practical to remove wall panels for expansion of the building.

The architect and contractor used "tilt-up" construction of precast cement sandwich panels. These sections are 10 by 12 feet, by 10 inches thick. The sandwich construction consists of one 5-inch concrete slab (outer) and one 3-inch concrete slab (inner) with a 2-inch layer of Foamglas in between—all poured in one operation to form a precast unit. Foamglas was used primarily for acoustical reasons, however, thermal insulation benefits were also derived from this construction. "Tilt-up" construction not only makes expansion of a concrete structure quite practical but also materially shortened over-all construction time, since it was possible to pour the "tilt-up" panels while the "foundation and

steel" work was in progress. When the steel frame of the building was completed, it required only a few days for a crane operator to set the "tilt-up" panels into place and close in the building.

Sandwich-type panels are also used for the roof of the studio, however, the 3-inch part of the sandwich is of lightweight concrete rather than the regular concrete used in wall sections. Studio floors are of sandwich construction consisting of a bottom (base) slab of concrete covered with a ½-inch thick layer of Corktite, upon which was poured a top layer of concrete. Expansion joints were then cut into the top layer of concrete with a saw while the floor was still "green." This resulted in a smoother floor surface for camera work than the usual troweled expansion joint, and has proved extremely satisfactory.

### TV Studios

Our station is enhanced with very good studio space consisting of Studio A, 60 by 80 feet, and Studio B, 30 by 40 feet. Studio A has a drive-in door leading to the prop and scenery storage room, thence to the loading dock or drive-in ramp for passage of anything up to the size of a small truck. There is an exit door large enough to quickly pass the cameras to the outdoor studio. The latter is located on a cement patio, 40 by 60 feet, which has the same smooth type concrete floor as the studios. An immediately adjacent area has partial walls of various kinds of masonry and California redwood. This enclosed area has been landscaped, sodded with lawn grass, includes a fish pond and picnic tables. This has proven a nice addition to our facilities with excellent commercial

FIG. 8. Typical use of outdoor studio.







FIG. 9. Lighting control panel located in control room.

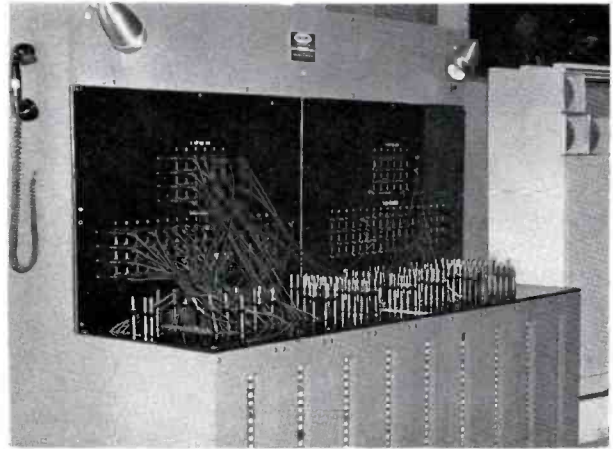

FIG. 10. Patch panel of lighting system has 240-circuit capacity.

possibilities as a setting for the display and demonstration of lawn and garden furniture, nursery stock and sporting goods.

Studio B is on the same level as Studio A. It too has a drive-in door leading to the prop and scenery storage. This storage room is common to both studios. Studios A and B are connected by an oversize door to allow quick passage of camera. Both studios have 24-foot ceilings and are adequately air conditioned (200 tons for the building).

We have two TK-31 Field Cameras, one on a field tripod and dolly, the other on a studio pedestal. These cameras are used in both indoor studios, the outdoor studio and also for remotes. A Bodde dual (5000 watts per side) rear screen projector and an 8 by 10-foot screen is used in Studio A. Other equipment includes two Century

microphone booms as well as an abundant supply of 77-D, BK-1, BK-6A and BK-6B Microphones with one RCA Star-Maker.

Camera cables for studio work come from the center of Studio A, through an opening in the floor. Working from the center reduces cable drag to a minimum. These cables can reach into Studio B and outdoors to the patio studio. Microphone outlets, intercom and lighting cables are all overhead to provide a "clean" floor for best camera work.

#### Studio Lighting

Our lighting consists of a Century-Izenour lighting system. Switching and dimming controls are located in TV control room. This is an electronic control dimmer system using very small voltages to control thyratron tubes, which handle the light

loads. The thyratron tube dimmer bank and booster transformer assembly is in a room just below the control room while the interplug and jack unit is on the control end of the Studio A floor. This system has six 5-kw dimmer circuits and eighteen 5-kw nondim circuits.

The system includes a preset panel which is designed to handle the complete 18 dimmer circuits in as many as 5 different preset combinations. Any of the 18 circuits may be dimmed individually or all may be dimmed simultaneously by a master dimmer control. The lights are hung on Century Monorail and consist of numerous 16-inch scoops, 8-inch spots, 6-inch spots and leko pattern lights. There are a total of 200 twenty-amp and 40 fifty-amp circuits available on the interplug board.

FIG. 11. Master control, at left, showing two operators. Studio control at right showing three operators, has following arrangement (left to right): tape recorder and microphone patch panel; two BQ-2B Turntables; audio control; director's position; video control, lighting.



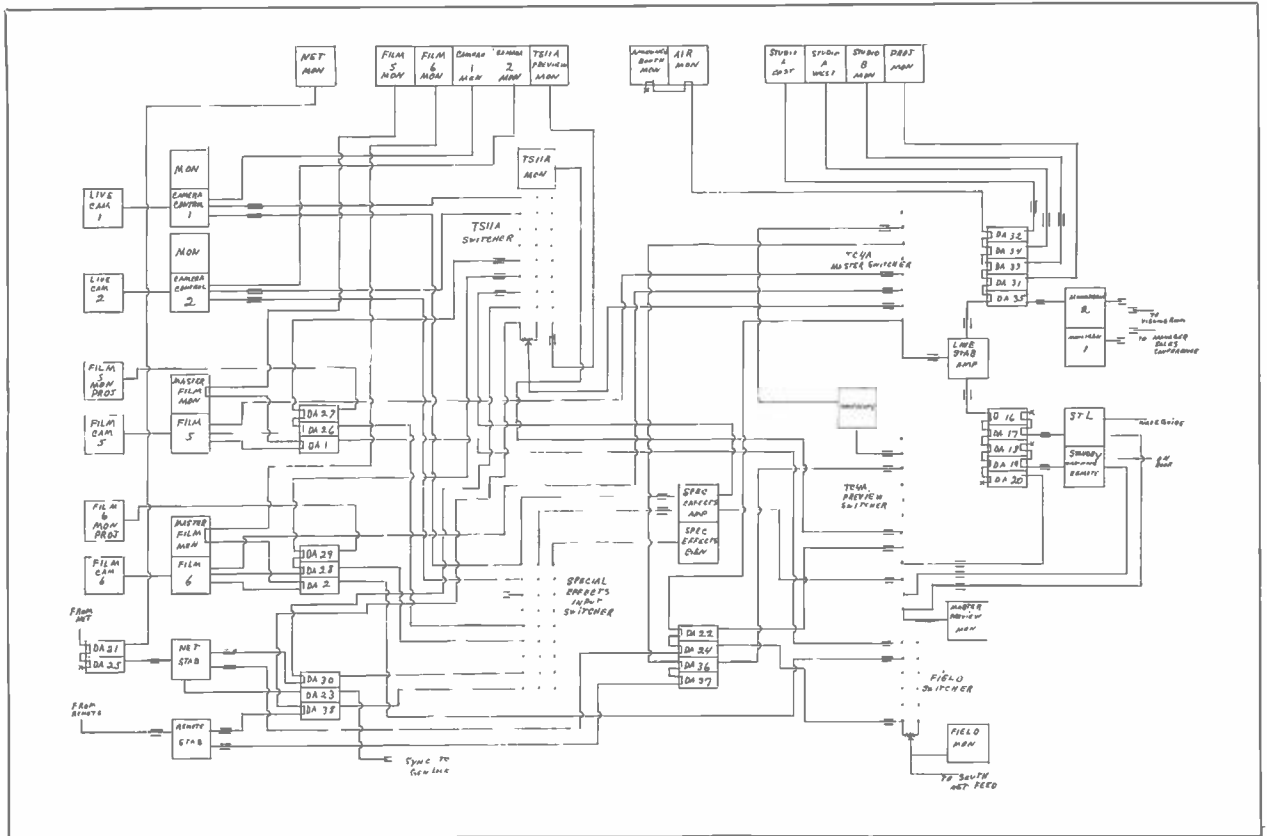

FIG. 12. Video block diagram.

FIG. 13. Modification of BC-2B Audio Console by KAKE engineers to accomplish feed of "air" turntables to "on air" studio without any feedback problems.

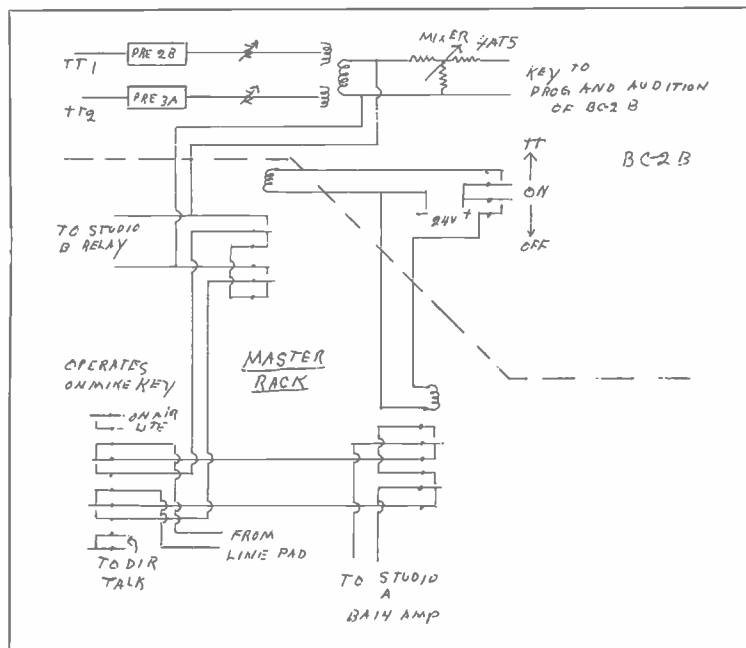
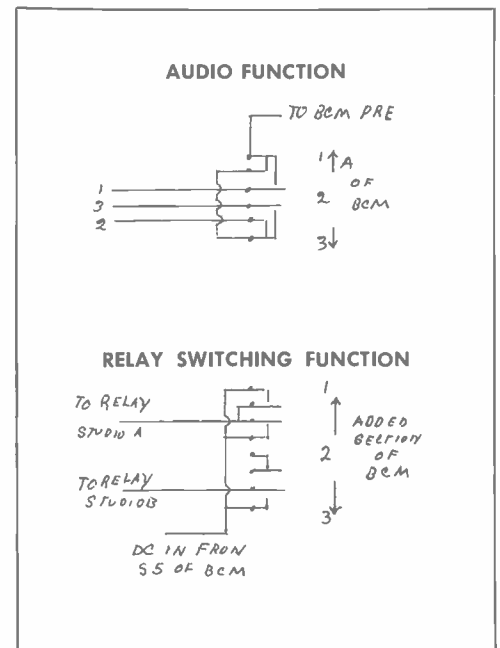

FIG. 14. Modification made in BCM Auxiliary Mixer to accomplish relay switching with mike selector key using new switch: stock number 94139.





## Control Room

In our control room we have three audio-video switching centers. One is at the studio control position and two are at the master control position. Each can be operated independently of the others, providing complete rehearsal facilities while on air. This also provides us with good standby switching facilities in the event of "technical difficulties."

## Studio Control

The audio (see Fig. 11) at the studio control position consists of a BC-2B Console, BCM Auxiliary Mixer, two turntables, aural tape recorder and mike patching system. To keep this position as simple as possible, we have set up the BCM so that the No. 1 and No. 2 mike input switch positions of all four mixers are for Studio A and the No. 3 position is for Studio B. This required changing the switches in the unit to accommodate the necessary relay switching (see Fig. 13). We installed fader cue pots on the turntables and they are mixed before going to a master pot on the BC-2B. This permits a simple feed of the turntable audio onto the studio floor when necessary without danger of feedback when a mike is open.

Next is the director's table (see Fig. 11) and switches for a director's paging system are located here for his convenience. He can talk to all the working positions, studios, patio, master control, projection, announce booth, storage, and dressing rooms by "press-to-talk" switches. The special effects controls are also at this position and consist of three video switchers. (MI-26277). Two are for the special effects amplifier inputs and the third for the external keying input of the generator. The usual interphones to the cameras and floor are also used here.

The studio video position (see Fig. 11) is normally operated by one person, and is made up of a TS-11A Switcher and two field camera controls. At the right of the video operator is the Century-Izenour lighting control board. If a live studio program involves too much light switching for the video operator to handle, then the operator at master control is available to assist.

For the convenience of all personnel in the studio control position, a row of seven RCA utility monitors are mounted just above eye level to show all video signal sources as well as the outgoing signal to the transmitter and an "off-the-air" receiver. The TS-11A Preview Monitor used for "matching cameras" and previewing spe-



FIG. 15. Rack equipment behind master control: terminal equipment for audio and video; stabilizing and distribution amplifiers; and power supplies.

cial effects or other video signals is included in this line up. The seven monitors (left to right) are as follows: Network, On Air, Film 6, Film 5, Live Camera 1, Live Camera 2. Preview of Special Effects.

## Master Control

This position from left to right consists of: First, a TM-6 Master Monitor with monitor switcher for previewing all video input signals as well as other critical monitoring positions, including the detector outputs of the microwave transmitters.

Second, is the master switcher, a TC-4A Audio/Video Switcher which handles all available signal sources as separate or interlocked audio and video (except studio microphones and live cameras). The TC-4A, of course, includes an audio monitor system with separate speaker.

Third, are remote controls for three stabilizing amplifiers, to which have been added local/remote switches and relays (on stabilizing amps) for use in sync selection when using the genlock system. Below this in the console housing is the sync generator change-over switch panel, intercom speakers, and press-to-talk switches. These switches are connected with the director's paging system to allow master to talk to all critical operating positions. Fourth and fifth are the two vidicon film camera controls and monitors installed in a normal manner.

A turntable is located at the extreme left end of master control and an "on-air" speaker at right. MC is normally operated by one person, however, two or more engineers are used when we are engaged in network switching.

Sixth, to the right of the film camera controls we have set up our field switcher, remote audio unit, and remote TM-6 Master Monitor. This is used in conjunction with requests from the ABC network for inserting commercials in various programs fed on a loop through KAKE-TV to stations south of Kansas. (This also gives us a standby for either studio or master position switcher.)

## Rack Equipment

Located behind master control are the necessary racks of terminal equipment. Here are the vidicon camera units, distribution amplifiers, stabilizing amplifiers, microwave controls, special effects equipment and monoscope camera. Also studio and field synchronizing generators, with change-over switch, video patching, and two monitran units. Finally, all necessary power supplies, master audio patching and amplifier systems. Above these racks is a plenum chamber from which three exhaust fans draw off the hot air, enabling the air-conditioning system to operate at higher efficiency.



FIG. 16. KAKE-TV film room. There are two vidicon film chains, two TP-6 16-mm Projectors, two TP-11 Multiplexers, a telop, two TP-3C 35-mm Projectors. At far right, note 8-mm movie projector.

#### Film Room

The projection room is set up so there is convenient full vision to and from the master and studio control positions, also the announce booth.

The room is approximately 17 by 30 feet with an adjacent area 11 by 30 feet available if needed by simple removal of a temporary nonload-bearing partition.

The equipment here consists of two TK-21 Vidicon Film Cameras, each mounted on a TP-11 Multiplexer. One camera has three picture sources: No. 1, Gray 2B telejector, No. 2, Gray telop with both vertical and horizontal crawl, and No. 3, an RCA TP-6 Film Projector. The other vidicon camera has four optical sources: No. 1, Gray 2B telejector, No. 2, RCA TP-6

16-mm Projector, No. 3, an 8-mm film projector, and No. 4, a special station-built opaque projector.

The 8-mm movie projector was designed for proper television synchronizing by KAKE personnel for news use. The special opaque projector is a unit added in the full mirror position of the TP-11 Multiplexer which can show anything opaque from 4 by 5, to 15 by 20 inches. We use this primarily for showing news pictures from the photofax machine and flip cards during times when live cameras are not available; also to show our IBM clock for time-of-day.

A film-cleaning machine and the necessary tables for doing occasional film work are also located here, however, the film splicing, editing, receiving and shipping are done elsewhere in the building.

There is a utility monitor for each camera, plus an "on-air" monitor in this room. Tally lights are used at these monitor positions for convenience. The projector controls are located so all units can be operated from one common position and a microphone is mounted here so the projectionist can talk to the master and director positions.

Under our philosophy, controls for film-room operation are located in the film room rather than at the master control. There is a projectionist on duty at all times. He starts and stops the projectors, changes slides and loads film. Only the video switching and shading of the signal is done at the master control.

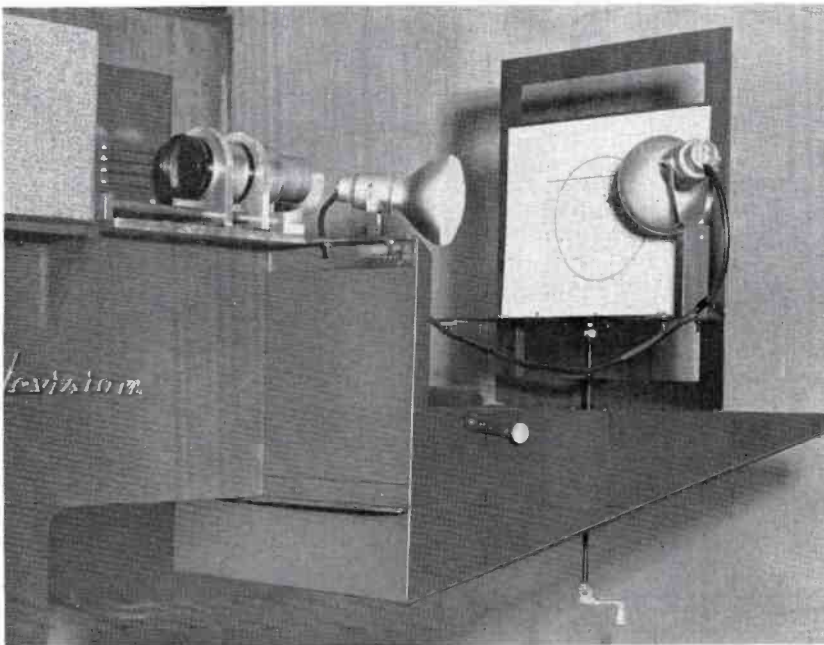

FIG. 17. Station-built opaque projector. Also used for live commercials, flip cards and time signals.



### News Operation

The KAKE Newsroom is a combined facility to supply information to both television and radio audiences. Behind the scenes is an adequate facility to provide visual news and a camera correspondent force of 85 persons supplying picture coverage of the Kansas and Oklahoma area. The internal facility at KAKE-TV includes a direct weather wire, radio wire, AP Photofax, and a staff of 12 to film, edit, write and deliver the news on air.

Mobile radio cars manned by camera-reporters film "on-the-spot" news events, and protect KAKE Radio News with on-the-spot reporting. TV News also uses the mobile radio on late-breaking stories and several visuals are used in such cases. A stock of telops is prepared in blank for street intersections and railroad crossings. These can be quickly completed for one type of visual. Maps and file pictures are also used.

### 8-MM Conversion

We quite often have had 8-mm amateurs come in with film they have taken on the spot of a fire, accident and even twisters (Kansas has its share). This, of course, never hits the news since 16-mm was all we could handle. We did get to thinking of 8-mm and how we might make use of it. We made a survey of our camera correspondents and discovered that a considerable number had 8-mm movie cameras.

This resulted in turning the challenge over to Paul Elder of our Projection Department. He came up with an 8-mm conversion that would synchronize with the video system. It took some time to work out the modification but now we can handle 8-mm film. The 8-mm adaption is set for use of film exposed at 16 frames a second, which is what most amateurs use for a standard speed.

Problem: movies brought in by amateurs are often exposed on Kodachrome film. We have solved this problem after experimentation. We advise that color in the film will be lost and then we process it as black and white. Results are satisfactory.

### Equipment for News

As for equipment, KAKE-TV has an Auricon Pro-200 equipped with a TVT shutter and modified for a capacity of 1200 feet. This makes it possible to kine shows and commercials. A second Auricon Cine Voice equipped with a transistor amplifier attached to the camera is used for spot news sound coverage. Silent hand cameras include three Bell & Howell, one Bolex, Cine Special, and Keystone.

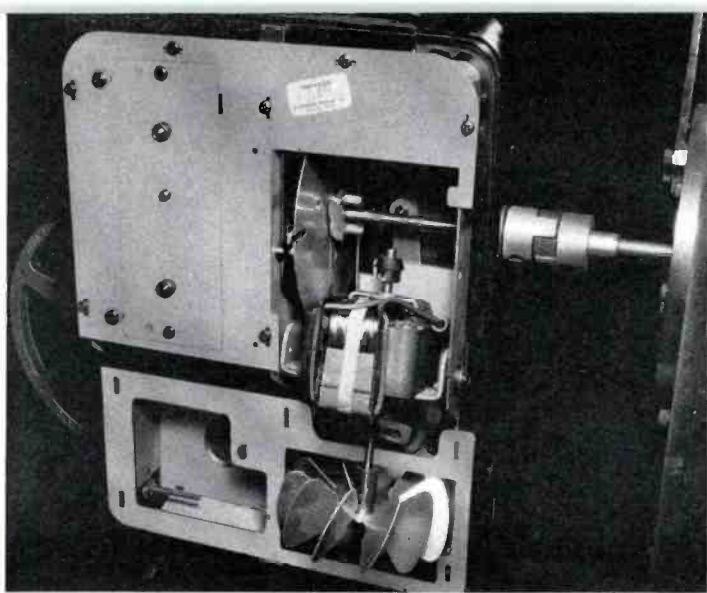

FIG. 18. Modification of 8-mm projector in order to synchronize film shot at 16 fps with the TV video system.

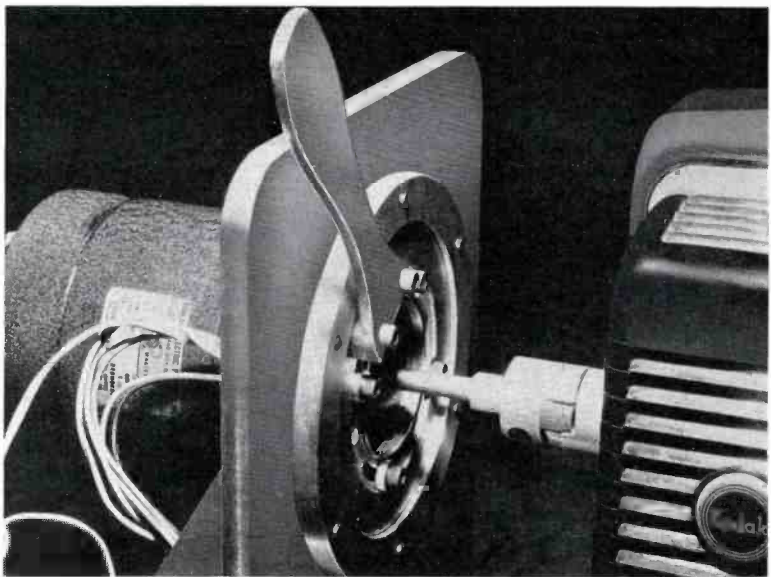

FIG. 19. Handle to control phasing of special 8-mm shutter.

FIG. 20. Modified shutter for 8-mm movie projector, shown at left. Regular shutter is at right.

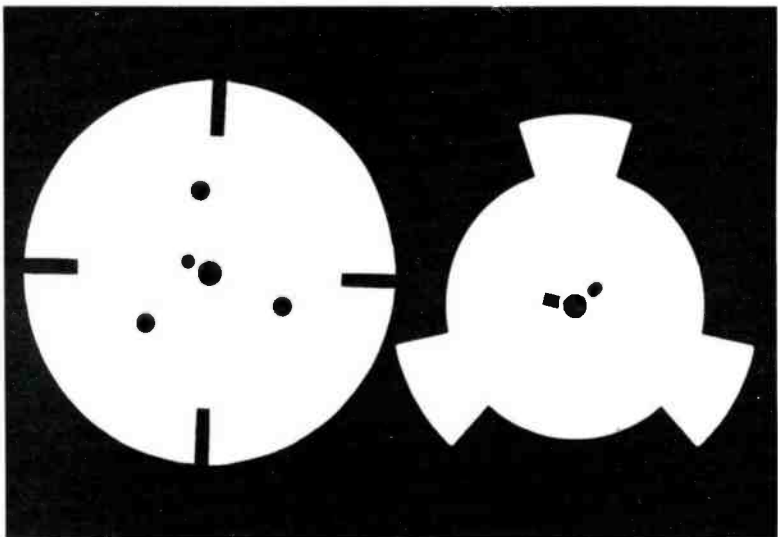



FIG. 21. Control room No. 1 for KAKE radio. Seated at controls is Warren Rashleigh.

In the newsroom we have a monitor desk on which are located receivers tuned to police, sheriff, fire, highway patrol and turnpike frequencies. This is also the desk for contact with mobile units to set up news remotes. Radio newscasts also originate from this same room.

#### KAKE Radio†

Planning for the new AM radio, studies were begun several months before the new combined radio and TV building reached the construction stage.

Before the actual layout work began, considerable time was devoted to a study of changes which have occurred in radio programming techniques and requirements.

We were aware of the combined announcer-control room engineer-type operation and the main on-air control room was designed with the announcer in mind, so technical equipment was kept to a minimum in this room. The operating tables were made large and everything can be accomplished from a sitting position. The tape recorders, patch panel and remote

control units are placed at the back edge of one of the long operating tables. The other table, placed to form an L shape, contains the BC-2B Console and two BQ-1A Fine Groove Turntables. A third turntable, BQ-70F, used primarily for commercials, is at the announcer's right hand.

The second control room which has the same proportions as the on-air control room, is used for recording. Here we have the speech racks for monitors, Conelrad receiver, recording amplifiers and tape recorders. One rack also contains a patch panel which parallels the patch panel in the on-air control room.

All microphones in both studios, network lines (MBS and ABC), remote lines and monitoring lines are common to both control rooms. This is accomplished by using divider pads. On-air studio lights and monitor speakers are controlled by either or both consoles.

Studio soundproofing was accomplished by using floating construction. Studio A, on-air control room, Studio B, and the recording room are each a room within a room, completely isolated acoustically from each other and the rest of the building.

#### Transmitter Location

The KAKE-TV transmitter building is located on a 43-acre tract of farm land, in a rural area 14 miles northwest of the business district of Wichita, and 12 miles northwest of the studio site. There is excellent accessibility to the transmitter site via paved Kansas State Highway 96. This location was chosen in order to build a taller TV antenna tower than was possible in the city proper since KAKE-TV desired to build a maximum power, maximum coverage station.

The 1079-foot antenna-tower installation is the highest man-made structure in the state. The studio to transmitter program path is a nine-mile microwave hop. An eight by ten-foot passive reflector is mounted 297 feet above ground on the TV antenna tower to reflect the signals into the four-foot microwave dishes mounted on the transmitter building roof (immediately above the video terminal equipment racks in the transmitter control area).

† The complete story of KAKE AM radio operation (before construction of new combined radio and TV building) was published in *Broadcast News*, Vol. 56, Sept., 1949.



FIG. 22. Control room No. 2 for KAKE radio. Seated at controls is David Dunn. Standing is Radio Chief Engineer, Gene Courtney.





FIG. 23. KAKE-TV transmitter building (includes apartment of resident engineer).

### Transmitter Equipment

The 50-kw TV Transmitter, Type TT-50AH, floor layout is typical RCA with the exception that all blowers are located in one room. We removed the two driver blowers from the transmitter and set them in the one common blower room with the P.A. blowers. We have an 11 by 34-foot work area behind the transmitter equipment and a 13 by 34-foot control area. Video and microwave equipment is located in three terminal racks to the right of the control console, which is centered in front of the transmitter cubicles. The audio terminal equipment, frequency and modulation monitors are in two racks to the left of the control console.

The transmitter driver section is set flush into a cemento panel wall, thus providing a control room separated from the area containing the work shop, blowers, dehydrator, heavy transmitter equipment, storage, etc. This allows good lighting in the shop area with subdued lighting in the control room at the same time, and also serves to reduce blower noise level considerably in the control area for better aural monitoring. The sideband filter is ceiling mounted to conserve floor and wall space and also to protect it from any possible physical damage.

The driver and power amplifier blowers are located in one common blower room and supply air through ducts under the floor to their respective cubicles. Air from the top of the transmitter cubicles is drawn off by a 2½-horsepower exhaust fan. A thermostat in the blower room controls motor-operated louvers to either exhaust the return air outside, or mix it with incoming fresh air to maintain a given temperature in the plenum chamber. One end of the blower room opens to the outside



FIG. 24. (Left) STL link waveguide feeds directly through roof into video racks beneath. (Right) Remote pick-up microwave unit, placed on roof as STL standby when not in use for remote work.

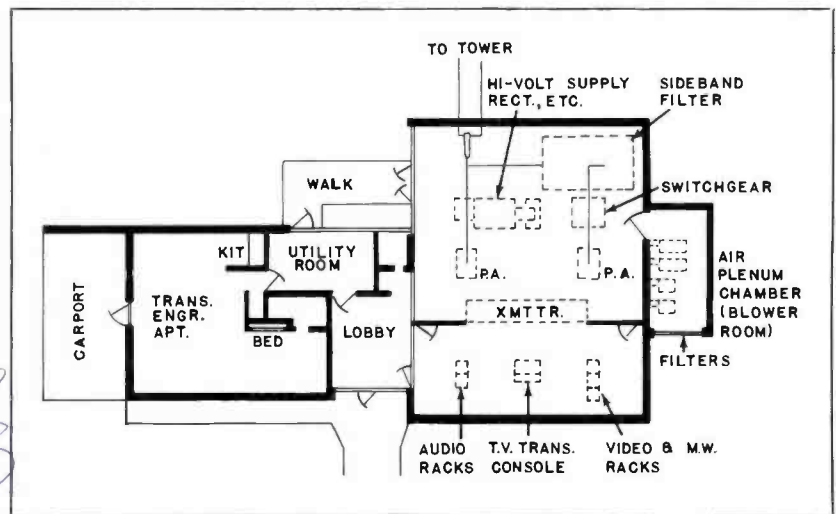

FIG. 25. Floor plan of transmitter building.

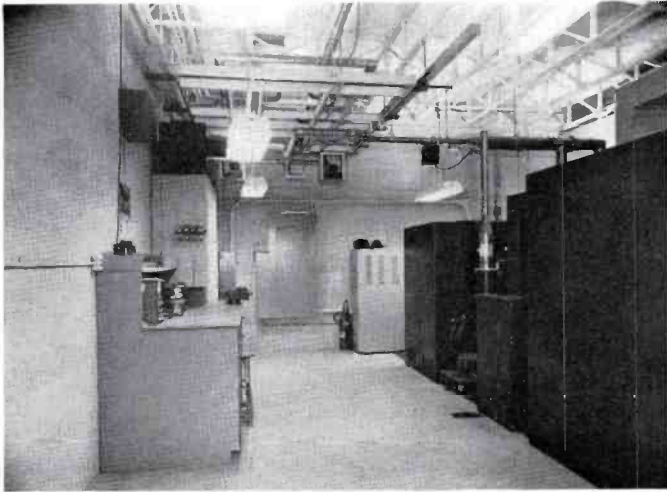

FIG. 26. There is a large area behind transmitter gear for workbench and parts storage. Note ceiling-mounted sideband filter.

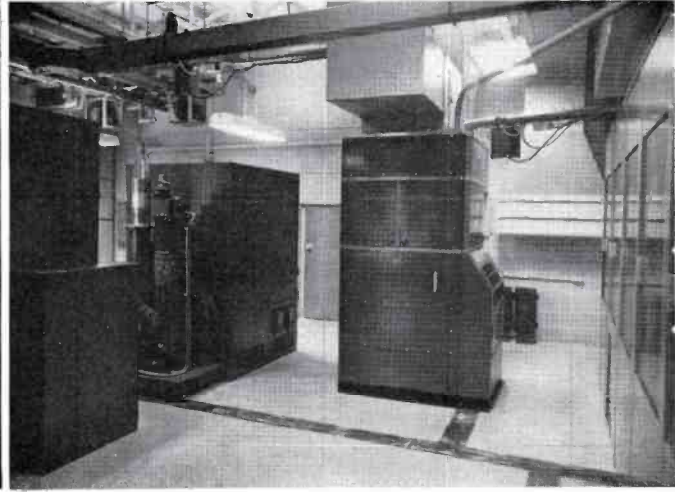
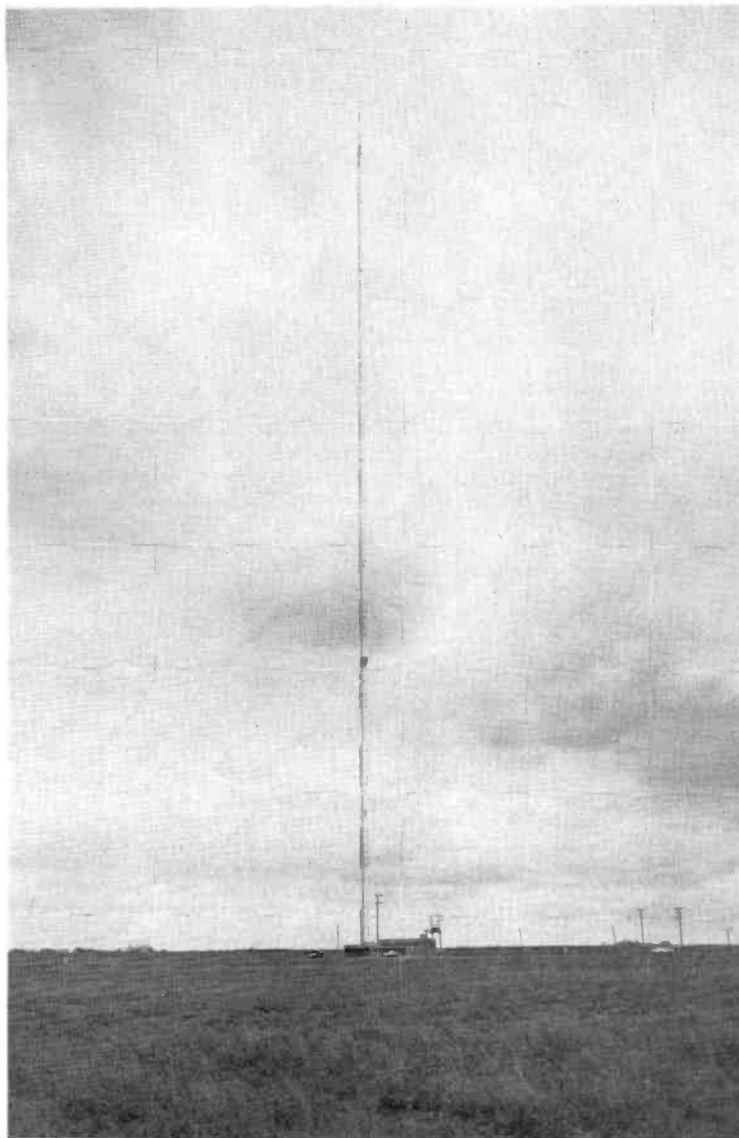

FIG. 27. Note 50-kw amplifier, switchgear and power equipment behind transmitter. In rear is door to air plenum chamber.

FIG. 28. KAKE-TV transmitter site. Terrain is flat. The 1000-ft. guyed tower supports a TF-12AH Antenna.



through 12 RCA Air Maze Filters which are weather protected on the outside by metal louvers. Additional filtering and cooling of the plenum chamber air supply, during hot and dusty days, is achieved by drawing the air through a secondary filter of cellulose wood fiber—kept moist with a fine water spray. This filter is mounted outside the blower room, in the air-intake opening ahead of the regular RCA Air Maze Filters.

This double filtering is effective in reducing in-drawn dust and also serves to lower the plenum chamber temperature by several degrees during our very hot summer days. Moisture or dampness from this secondary filtering has not been a problem.

#### Antenna System

KAKE-TV has a TF-12AH Antenna mounted atop a 1000-foot guyed tower giving a total over-all height of 1079 feet, with the center of radiation being 1032 above average terrain. A 50/50 power division combining network for the antenna was selected instead of the normal 70/30 network, in order to get the additional 4 percent power gain. We had no null filling problem to consider because of our rural transmitter location.

Two 40-foot lengths of  $3\frac{1}{8}$ -inch Teflon line are used from the diplexer to the base of the  $6\frac{1}{8}$ -inch steatite co-ax vertical runs inside the tower. Horizontal run is protected from falling ice by use of 4 by 4-inch redwood timbers on top of 4 inverted "L"-shaped steel supporting columns. This supporting structure is also used to anchor spring-loaded vertical rods which





FIG. 29. Rear view of transmitter cubicles. At left, are 50-kw power amplifiers. Note generous aisle area.

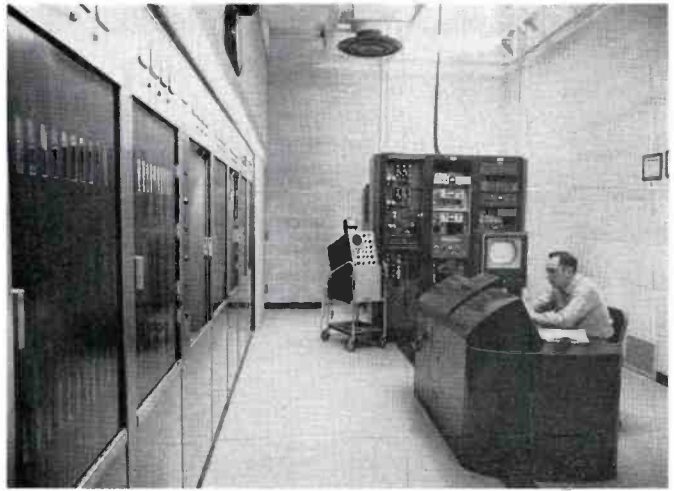

FIG. 30. Transmitter control area. Video and microwave racks are at rear. TV 50-kw Transmitter, Type TT-50AH appears at left. Shown at transmitter console is Paul Hinderliter.

support the horizontal transmission lines. A double-elbow arrangement is used to reduce the spacing between the two  $3\frac{1}{8}$ -inch lines coming from the building and this connects to the  $6\frac{1}{8}$ -inch reducers on the vertical runs. Double elbows are also used at the top of the vertical runs for spacing and alignment with 16-foot sections of  $3\frac{1}{8}$ -inch line used between these elbows and the combining network. Inter-communication and utility power outlets are spaced approximately 120 feet apart throughout the height of the tower. These facilities have been most helpful during times of antenna-tower maintenance.

#### Station Success

We have found our building design and layout to be very functional in actual operation. Equipment choice and arrangements have also worked out well. Furthermore, our studio control room and studios are so designed that color can be added with a minimum of change. We also have space (in our present control area) for video tape recording equipment.

Our experience with building design proves that it pays for a station and architect to work hand in hand. In our case, both technical and programming people in the station as well as the architect surveyed existing TV stations before proceeding. This pooling of knowledge has resulted in our excellent production facilities. To this, as well as our staff and our choice of equipment, we owe our success as a TV station in Wichita.



FIG. 31. Harold Newby, vice-president in charge of engineering, KAKE-TV and AM.



FIG. 32. Keith Griggs, studio engineering supervisor, KAKE-TV.



FIG. 33. Claude Clevenger, transmitter engineering supervisor, KAKE-TV.



FIG. 34. Paul Threlfall, manager TV and radio news, KAKE.

# U. S. ARMY SOUTHEASTERN SIGNAL HAS IMPORTANT

Photos by Edward J. Gibson, *U.S. Army, Specialist Third Class*



FIG. 1. Studio A in production, showing Pfc William B. Barth, audio technician; Pfc Jack W. Bremer, instructor; Pfc Joseph G. McMahon, cameraman; Cpl. Alfred C. Frothingham, cameraman.

## *Five-Channel System at Fort Gordon, Using 11 Camera Chains, Programs 175 to 200 Hours of Instruction Weekly*

*by JOHN C. MOFFITT, U. S. Army, Specialist Third Class*

Television in military education has become an important reality at the Army's largest signal school, the Southeastern Signal School, Fort Gordon, Georgia.

After several years of experimentation in studios not much larger than closets, with a minimum of equipment and a maximum of research by specialists such as George Washington University's Human Resources Research Office, results were so favorable that the Signal Corps decided educational TV was an important plus in military training. Last year it was decided that the time had come to expand. By October 1957, the Army was

ready to open, at Fort Gordon, one of the best equipped educational television operations in the country.

On October 16, 1957, the Undersecretary of the Army, Charles C. Finucane, officially opened the doors of USASESCS-TV's largely RCA-equipped operations center. The operations center, one of the buildings belonging to the Signal School's television studio, contains two studios and control rooms, a master control, telecine, kinescope recording room, maintenance shop, and prop room.

Flanking the operations center are an administration building with film depart-



# SCHOOL FINDS EDUCATIONAL TV PLACE IN MILITARY TRAINING

ment and viewing room, a supply building, and a combined production center and art department building. Chief of the television facility is Lt. Col. Hamilton T. Crowell.

The chief technical advisers to Col. Crowell are Field Representatives of the RCA Service Company whose responsibility it is to supervise the installation, operation and maintenance of all equipment used. This is no slight job when that equipment includes 11 camera chains now in operation and 2 more on order, film projectors, microwave links, coaxial distribution system, several dozen receivers, racks full of control and transmission equipment, audio consoles, microphones, mike boom and perambulator and—that cinemascope of television—an RCA PT 100A Large Screen Television Projector.

Under their guidance, two pedestal-mounted TK-31 Image Orthicon Chains have been installed and are in use in the 2400-foot workhorse Studio "A." A TK-15 tripod-mounted studio vidicon is included in the studio's camera complement for flip-card use. This type of camera was found to be extremely useful due to its quality of not burning in on cards on which it may be held for some time. Flip cards are very often used in classroom instructional kinescopes.

For multiple-set productions such as the recent Christmas Safety Show—a post-wide presentation to dramatically emphasize safety over the Christmas holidays—a third image orthicon chain is added.

The audio technician has his choice of three types of RCA microphones: the versatile 77-DX, most frequently used for boom work; the BK-6A, where a boom is impractical and a narrator must move about; and the BK-1A for desk work in conference presentations and short VIP orientations. The control unit is an audio console BC-2B.

Studio "B," though smaller, is equipped with the same camera and microphone complement as its sister studio, but is without boom and perambulator. Further, it is lighted by fluorescent banks instead of the scoops and fresnel of Studio "A." The smaller studio, now the laboratory domain of RCA Field Representatives, will eventually be geared to short live and slide presentations such as the often-



FIG. 2. Fort Gordon, Georgia, TV Studio Chief, Lt. Col. Hamilton T. Crowell.

FIG. 3. Control racks at master control showing Sgt. Ronald D. Bean, chief of master control and RCA Field Engineer, Charles F. Tarver, trouble-shooting a stabilizing amplifier.

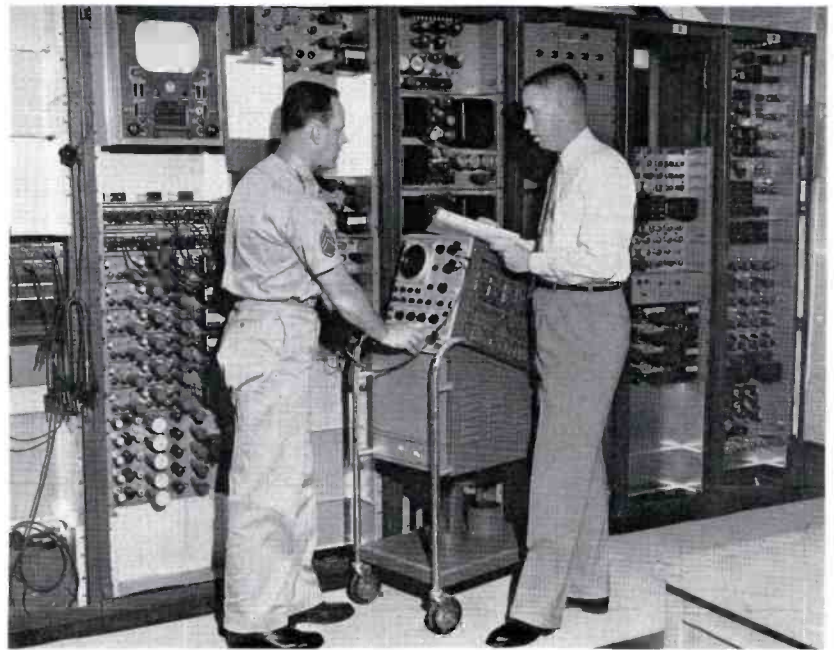

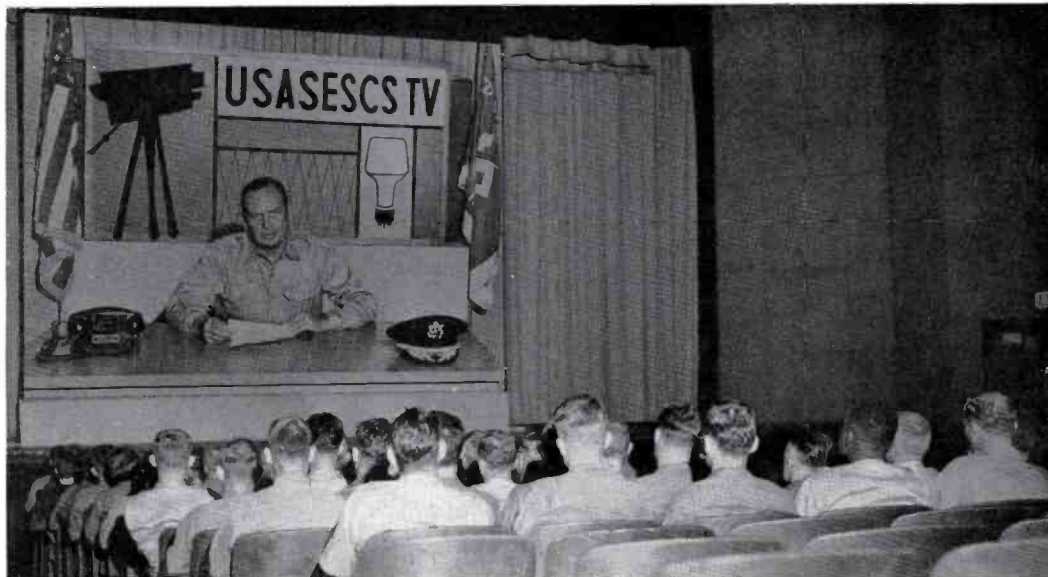

FIG. 4. Members of the Fort Gordon TV Branch gather at Theater No. 3 to view an educational TV presentation.

recurring television "cook's tour" of the Signal Center for VIPs, and a planned, ten-minute, between classes news, weather, announcement "daily bulletin" program.

The bulk of the output here at USA-SESCS-TV is in the form of thirty to forty-five minute kinescoped class periods for use in one or more of the school's 18 courses. These range from imaginative treatments of abstract subjects such as "The Electron Theory" and "Magnetism"

to dramatized procedures for "Trouble-shooting Radio Teletypewriter Receiving Circuits."

The kinescopes are projected on four TP-16F Film Projectors and picked up by four TK-21 Vidicon Chains, mounted on the projectors. One additional projector and vidicon chain are on order and will be set up with a multiplexer, enabling both a 16-mm projector and 35-mm slide projector to be used with it.

The signals then go through master control where they are patched into one of the transmitters and fed into either the coaxial or microwave distribution system.

USASESCS-TV is able to telecast simultaneously, at present, over a maximum of five VHF channels. With the acquisition of an additional projector, soon to arrive, this number will be raised to six.

Students see and hear the televised periods in the classrooms on standard r-f receivers, or in a thousand-seat auditorium by means of the PT-100A Large Screen Theatre Television Projector. The entire ROTC Summer Camp receives television instruction here each year, and, in a few showings, the annual Christmas Safety Shows reach the entire post. Special demonstrations of new equipment in close-up are presented in this manner as well as conferences, officers' calls and other official meetings.

The backbone of the equipment, upon which the whole operation is based, has been supplied by RCA; as well as the technical advice through their representatives, insuring proper installation, operation and maintenance. It is the Army specialists who are doing the job, but the important reality is that television in military education has been speeded by the helping hand of RCA.

The use of television at the U. S. Army Southeastern Signal School has skyrocketed in the past few months. Between 175 and 200 hours of instructional programs are televised each week, and all 18 courses are adjusting to make maximum use of the new educational medium.

FIG. 5. Telecine with RCA film vidicon cameras and 16-mm projectors showing RCA Field Engineer, William G. Bedsole, and Pfc David H. Chute, telecine operator, adjusting projector.

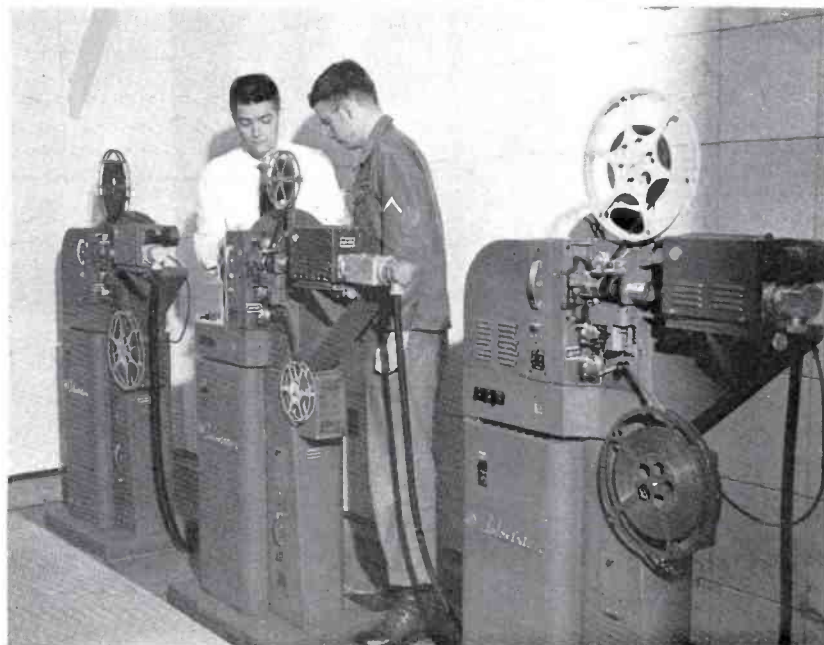



# CHARLES H. COLLEDGE APPOINTED GENERAL MANAGER, RCA BROADCAST AND TELEVISION EQUIPMENT DIVISION

The formation of a new sales division within RCA Industrial Electronic Products was recently announced by Theodore A. Smith, its Executive Vice-President. Named as the first occupant of the post of General Manager, RCA Broadcast and Television Equipment Division, is Charles H. Colledge, one of the country's best-versed men in broadcasting operations. In the job he relinquished, NBC Vice-President of Facilities Operations, Mr. Colledge was in charge of operations for all NBC radio network, television network, and owned and operated stations. His staff was responsible for the supervision of 2600 people in such varied activities as technical operations, film operations and production, kinescope, video tape and radio recording, television and radio operations control and planning, network radio and television traffic and communications, design art and scenic production, studio and theatre plants and their maintenance, and the many other activities that take place behind the scenes in television and radio production.

Mr. Colledge is credited with introducing many advanced operational concepts in the broadcasting industry. Automation and equipment centralization are practices he advocated to limit error possibilities and to reduce maintenance and operating costs. His constant search for improved methods kept him in close touch with the RCA engineers and led to the incorporation of many of his suggestions in equipment designs. He has been identified with the present RCA compatible color television system from its earliest days through his assignment at RCA Laboratories between 1949 and 1951, when he headed Operations for Color Television, and through an earlier tour of duty as Television Operation Supervisor and Engineer in Charge of WRC and WRC-TV, NBC's stations, which gave him on-the-spot responsibility for early color demonstrations before the FCC.

In assuming his present function, Mr. Colledge feels a strong responsibility for providing the broadcaster with equipment that is at once reliable, competitively priced and designed in a manner calculated to keep operating costs low. Moreover, he believes that equipment innovations should always have capabilities of attracting new business to the station.



Charles H. Colledge joined NBC in November 1933 as an engineer and during the next nine years worked in all technical aspects of broadcasting. He took a military leave of absence during World War II to serve in the Navy as Officer in Charge of several radar projects in the Design Branch of the Bureau of Ships, Electronics Division. He was instrumental in developing many wartime equipments that were employed in combat, and his last assignment was on the staff of Admiral Blandy during the first atomic bomb test at Bikini Atoll in 1946. The Navy awarded him two commendation medals and he returned to civilian life in November 1946 as a lieutenant commander.

Mr. Colledge resumed his duties at NBC immediately and was transferred to Washington in charge of Television Studio and Field Engineering and soon thereafter was promoted to Television Operations Supervisor and Engineer in Charge of WRC and WRC-TV.

After the two-year term at RCA Laboratories, Colledge returned to New York in 1952 as Manager of NBC Network Public Affairs, Sports, Special Events and News

Production Operations. One year later he was promoted to Director of Operations and Engineering for NBC's owned and operated radio and television stations. In October 1956, he was promoted to Vice-President, Facilities Operations.

Mr. Colledge is a registered Professional Electrical and Electronics Engineer. He received his education at Columbia University, Newark College of Engineering, and Massachusetts Institute of Technology. His hobbies are golf and boating and he is a member of the National Society of Professional Engineers, Manasquan, N. J., River Golf Club, and the Mantoloking, N. J. Yacht Club. He married Margaret Whittaker of Short Hills, N. J., and they have two children, Charles E., 25, and William A., 22.

In addition to serving broadcast stations, the Broadcast and Television Equipment Division contains sales groups handling Closed-Circuit Television and High Power Radio Frequency Equipments.

Mr. E. C. Tracy continues as Manager of Station Equipment Marketing on Mr. Colledge's staff.

# 500-WATT TV TRANSMITTER AMPLIFIER

## TYPE TTL-500AL/AH

*Designed for Color and Monochrome, This Low-Power Unit Can be Used for Local Origination or Satellite Operation*

*by R. S. JOSE, Broadcast and Television Engineering*

The Type TTL-500AL/AH Amplifier has been designed for use as an amplifier following a TTL-100AL/AH Transmitter to produce a peak visual power output of 500 watts and an aural output of 300 watts. All VHF channels are covered: the TTL-500AL covers channels 2 to 6, while the TTL-500AH, channels 7 to 13. The amplifier is contained in a cabinet identical to that of a 100-watt Driver, Type TTL-100. For example, the view in Fig. 1 illustrates how the two racks (amplifier and driver), installed side by side, produce an attractively integrated installation. The 500-watt amplifier can be added to an existing TTL-100 Driver quite easily. The high and low channel amplifiers are the same except for the rf enclosure.

FIG. 1. When TTL-500AL/AH Transmitter doors are opened they reveal vertical chassis construction. Left cabinet contains 500-watt amplifier, modulator, and power supplies. At right the TTL-100AL/AH Driver is shown; note aural-visual exciter mounted at bottom of cabinet.

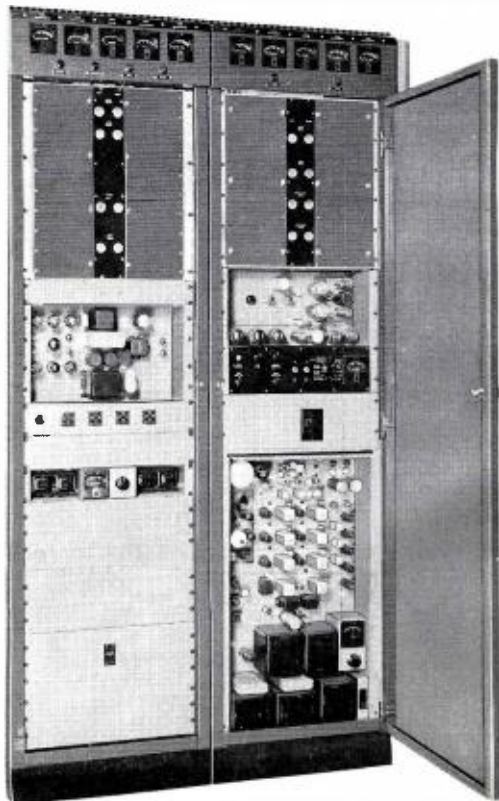

### Amplifier Circuits

The respective aural and visual amplifiers each utilize a 4X500A tube in a grounded grid, grounded screen circuit. The visual 4X500A tube is operated as a class "B" linear amplifier, and in the aural section another is operated as a class "C" amplifier. The two stages are mounted side by side in an enclosure similar to that used for the driver.

Figure 2, which is an interior view of the high-channel amplifier enclosure, shows some of the constructional details. The air sleeve, visible above the 4X500A tube, telescopes upward to allow rapid tube replacement. This air sleeve is seated on the anode to make dc and rf connections to the 4X500A plate circuit. An interlock switch, actuated when the air sleeve is in its proper position, is provided to prevent accidental application of screen voltage before plate voltage is applied.

The broadband visual plate circuits in both high and low band versions are double-tuned with mutual inductance coupling. The link and vacuum variable capacitor for secondary tuning are visible in Fig. 2. It will be noted in Fig. 2 that the aural and visual sides are very similar. Except where there is a left or right hand requirement on a part, they are otherwise identical.

The low-channel rf enclosure follows the pattern of the high-channel unit with regard to tube type, modes of operation, general circuitry and external physical size and appearance. The internal changes are those associated with the rf circuitry to accommodate the lower frequency range, which chiefly involves larger inductances.

### Compact, Efficient Power Supply

The high voltage power supply is common to both aural and visual amplifiers. It utilizes four germanium rectifiers in a bridge rectifier circuit. Since each of the four rectifiers in the bridge is the same, spares can be held to one type. The

rectifiers have an extremely long life expectancy, and with no deterioration of performance during their life. Consequently, no gradual loss of high voltage can be expected. The high conversion efficiency and compactness of the rectifiers are substantial factors in achieving the relatively small over-all physical size of the amplifier, while at the same time keeping the cabinet temperature low.

### Overload Protection

Adequate interruption speed for germanium rectifier protection is available in newly developed panel circuit breakers used in the ac primary leads. Since germanium rectifiers are destroyed by short duration excessive currents, the breakers

FIG. 2. Close-up of 500-watt amplifier and modulator sections. Air cooling sleeves are placed over 4X500A tubes. These sleeves telescope upward to make tube replacement easier. Both aural (left) and visual (right) amplifiers are very similar in construction.

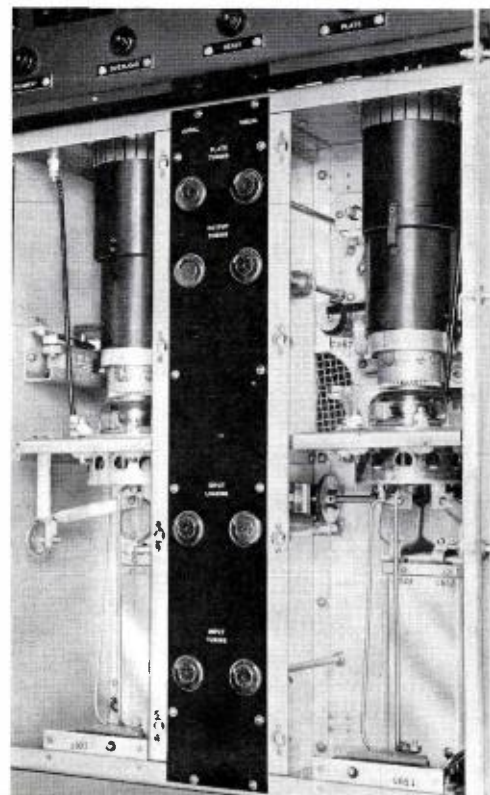





FIG. 3. Aural-visual exciter section of TTL-100AL/AH is easily tilted forward for servicing. Exciter is same type being used in many other RCA TV Transmitters, such as the TT-2BH, TT-6AL, and TT-25CL.

protective ability allow the advantages of the rectifiers to be realized without the necessity of using a more elaborate high-speed breaker. The filaments, blower, and low voltage are also protected in their respective ac lines by the same type of breaker.

Overload protection is provided in the negative dc power supply lead and the individual plates and screens of each 4X500A. The circuitry used is similar to that used in larger RCA television trans-

mitters of recent design. In this type of circuit a resistor is placed in series with the circuit to be protected, the value of the resistor being chosen so that one volt of drop is developed with nominal element current. The coil of a sensitive relay is connected across this resistor and adjusted to close when the coil voltage goes above one volt. The contacts of the relay, when closed, actuate the overload circuit which then must be manually reset to restore power. This protection is also high speed in operation.

#### Provisions for Remote Control

This overload circuitry is compatible with the RCA system of remote control. The necessary connections are brought out to terminal boards to facilitate remote control in case this alternative is permissible and desirable. Also if desired, an indicator panel assembly can be obtained for remote control use that will identify the circuit in which a dc overload occurs, by means of pilot lamps.

The screen voltage for aural and visual amplifiers, and bias voltage for the visual, are electronically regulated (see Fig. 4). The bathtub chassis below the rf box contains both supplies and their regulators which can be remotely controlled.

#### Cooling Provisions

The blower is contained in the bottom of the rack and the air filter is mounted in the rear door. The blower is floor rather than rack mounted to reduce the amount

of vibration transmitted to the racks. An air interlock is provided to protect the 4X500A tubes in case of blower failure.

#### Output Measurements

The separate aural and visual rf outputs appear at the top of the rack in standard 1 1/4-inch coaxial line termination. Standard RCA reflectometers are provided in each output line. By manual rotation, either the incident wave in the line or the reflected wave can be observed on a panel instrument. The calibrating potentiometers for these units appear just below the rf enclosure.

#### Driver Section

A standard TTL-100AL/AH Transmitter is used to drive the TTL-500AL/AH Amplifier. This 100-watt driver incorporates the new RCA Aural and Visual TV Exciter Unit\* (see Fig. 3). The TTL-500AL/AH is available as a complete transmitter, including the driver; or as a separate amplifier to increase power of TTL-100AL/AH Transmitters now in use (see Fig. 2).

#### Designed for Color

With the addition of the requisite input terminal gear and output filters, the transmitters will meet all color performance standards and are capable of producing the high quality color or monochrome picture reached by the present state of the art.

\* "A New Aural and Visual TV Exciter," *Broadcast News*, Vol. No. 99, Feb., 1958.

FIG. 4. This is the block diagram of the TTL-500AL/AH Transmitter. The sections shown in gray make up the power amplifier section, and the other sections are part of the TTL-100AL/AH Driver.

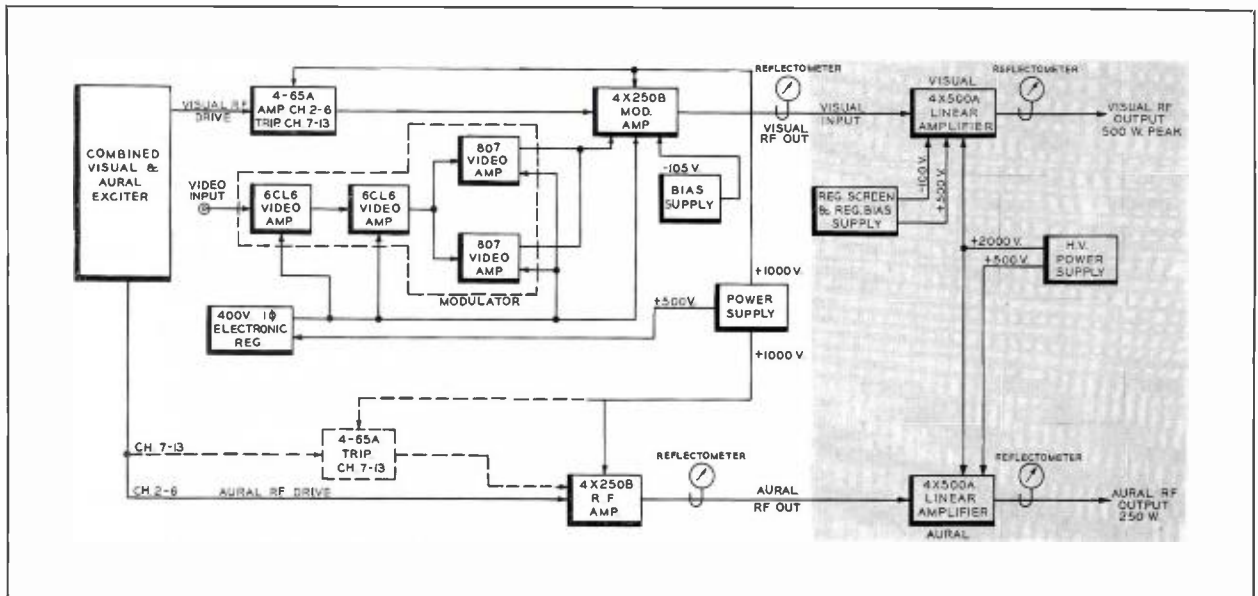

# ADAPTING RCA 16-MM TELEVISION FILM PROJECTORS FOR MAGNETIC REPRODUCTION OF SOUND

*Magnetic Sound Kits Now Available for Installation on  
TP-6 and TP-16 Series Film Projectors*

*by W. F. FISHER and R. E. MAINE, Broadcast and Television Engineering*

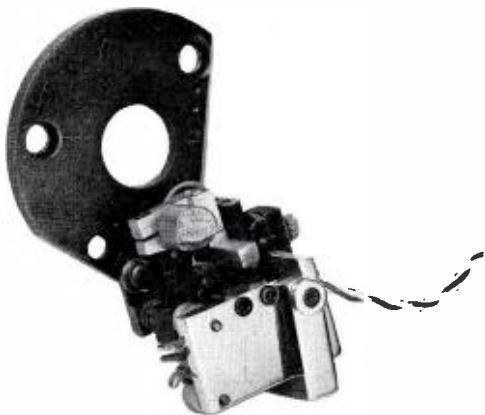

FIG. 1. Head-mount assembly with head in place. This unit is installed in the projector film path to pick up audio signal from striped film.

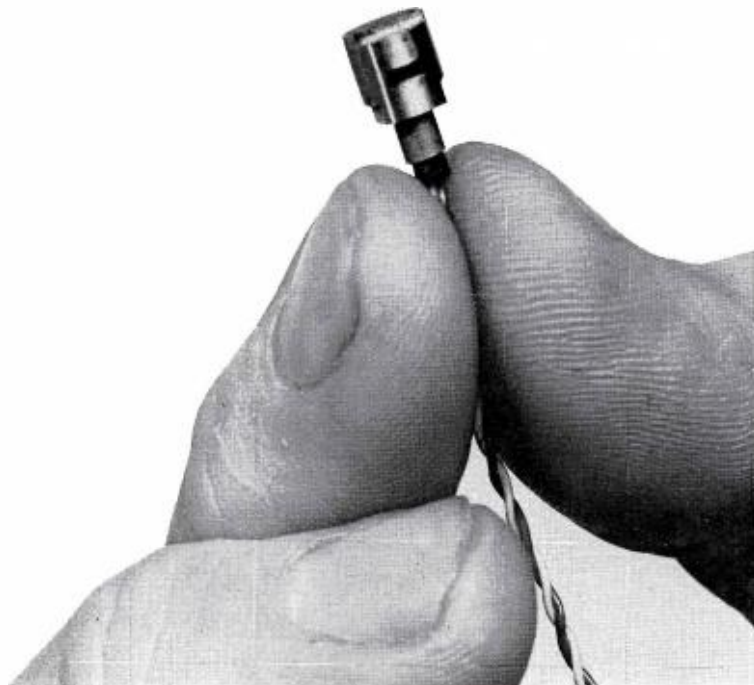

FIG. 2. Sound head removed from head mount. Enlargement reveals head size.

In many broadcast and closed-circuit television applications there has been increased interest in the reproduction of sound from 16-mm magnetic striped film. Broadcast stations have been able to speed the preparation of news films by reducing the processing time required between coverage and actual airing of the news event. Prestriped film also provides an easy means of applying commentary, music and sound effects on station produced film programs and commercials.

Closed-circuit television offers other possibilities for the advantageous use of magnetic sound. Flexibility of programming is provided when background music is applied or commentary is dubbed directly

on striped films. The facility for converting language on educational and training films increases its potential use and encourages the exchange of such films among various countries. This is one of the applications for which magnetic sound reproduction is intended, for example, in the closed-circuit installation at the Walter Reed Army Medical Center.

## Adapter Kits for RCA Projectors

Two adapter kits are presently available for TP-6 and TP-16 Series Film Projectors. Each kit consists essentially of a magnetic head, a group of parts for mounting and shielding the head, a magnetic sound preamplifier and a power supply providing filament and plate voltages for

both optical and magnetic sound preamplifiers. The nature of the modification is such that the kits may be installed by station personnel with a minimum of rework and without disturbing the alignment between the projector and film camera. The procedures discussed here are for TP-6 Projectors; however, they are substantially the same for the TP-16 Series.

## Mechanical Details

Two of the most important factors in reproducing quality sound from a magnetic medium are precise alignment of the gap with the sound track and good head contact. A head mount was designed which fits into the available space, places the head gap in the proper position, and pro-



vides accessible adjustments for tangency, facing, and azimuth. Figure 1 is a photograph of the head mount with the head in place. The head alone is shown in Fig. 2.

Contact between the head and the film is obtained by suspending the clamp block for the head in a cantilever arrangement through a leaf spring. The head normally rests about ten mils below the smooth surface of the sound drum when the projector is not running. As film moves through the projector, it is wrapped tightly around the sound drum and deflects the clamp block holding the head. A reactive force of approximately 12 to 15 grams is exerted between the head and the sound track. A force of this order of magnitude gives good head contact, but does not put sufficient frictional drag on the film to cause erratic velocity changes (with resultant flutter). In addition, longer head life may be expected.

Figure 3 shows the head installed in a TP-6 Projector. In order to secure the head mount to the main frame, a tapped hole is required. Optical reproduction is unaffected; the reflecting mirror is mounted as shown on the head-mounting bracket.

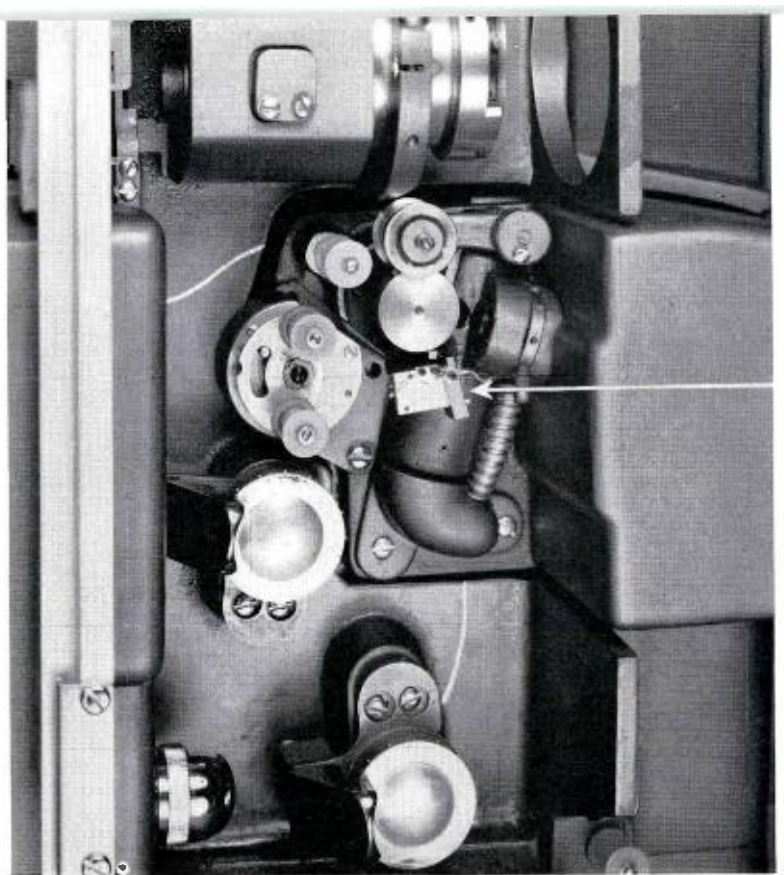
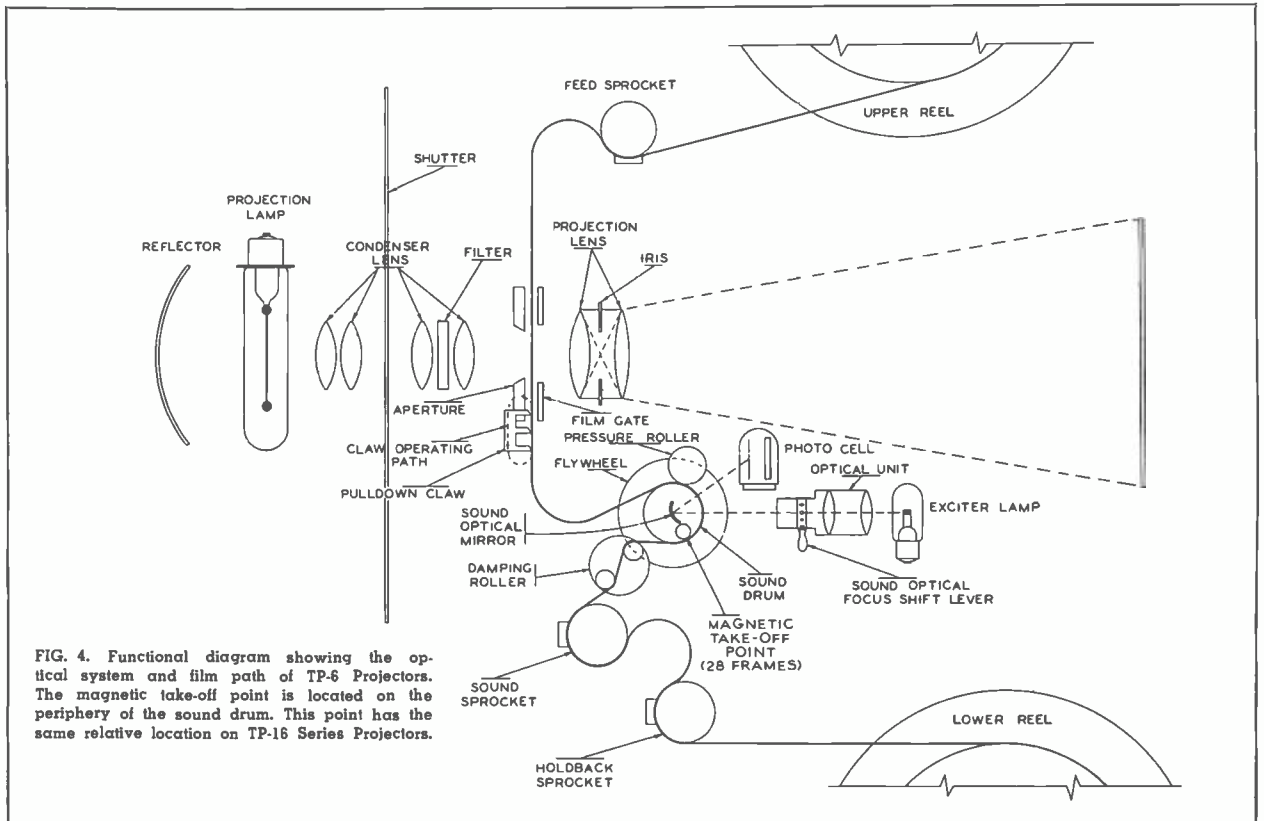

FIG. 3. Head mount installed in the film path of a TP-6 Projector (see arrow). This head mount may be similarly installed on TP-16 Projectors.



Power Supply

Pre-Amp.

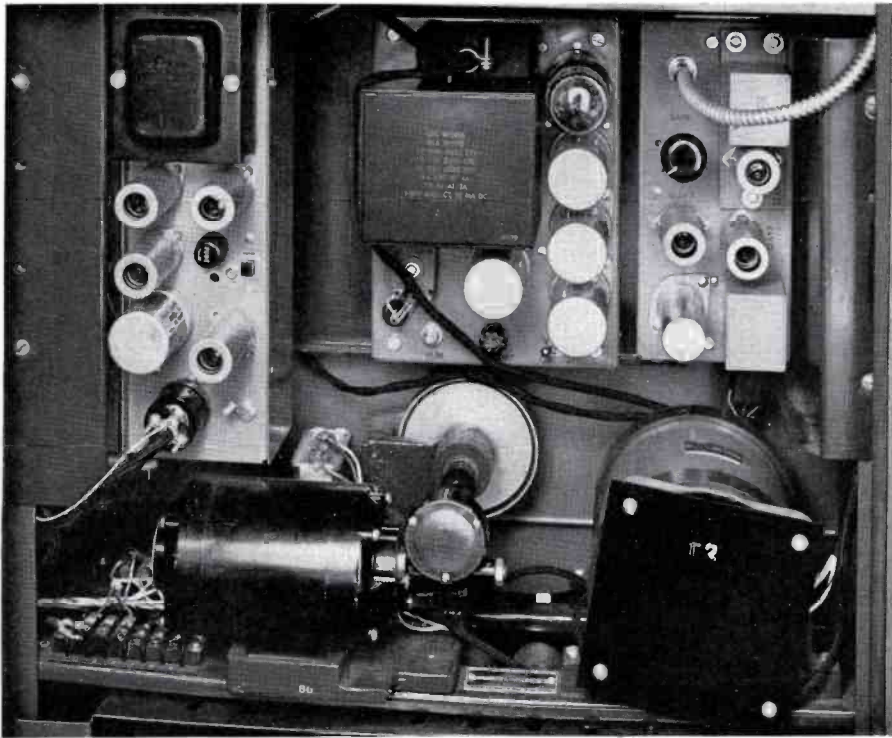

FIG. 5. A power supply and magnetic sound preamplifier are mounted as shown in the projector base. These equipments fit into the space formerly occupied by the power supply for the optical preamplifier alone. Power requirements for both optical and magnetic preamplifiers are accommodated by the new supply furnished with the conversion kit.

The film path of the projector as it is designed for optical reproduction is shown in Fig. 4. Here the film leaves the sound drum at nearly the point at which magnetic take-off occurs. With the use of magnetic stripe film it was found necessary to obtain additional wrap around the sound drum in order to insure maximum output and good head contact with curled film. The additional wrap of approximately one and one-half frames was obtained by redesigning the casting for the damping roller assembly. Two tapped holes are used to attach the new casting to the projector; one is existing and one is added.

The leads from the magnetic head are attached to a tightly twisted pair which carries the output to the magnetic preamplifier, located in the pedestal of the projector. The preamplifier and a power supply are mounted on a chassis which fits into the space formerly occupied by the power supply for the optical preamplifier (see Fig. 5). The power supply in the conversion kit will accommodate both the optical and the magnetic preamplifiers. When the main circuit breaker is on, both preamplifiers receive power. A rotary switch, mounted with two screws beneath the control panel, as shown in Fig. 6, selects the output from either the magnetic or optical preamplifier to feed the program line.

The total mechanical rework to install the magnetic sound reproducer consists of tapping four holes—one for the head mount, one for the damping roller casting and two for switch mounting.

A positive, detented, lever action lifts the magnetic head from contact with the film when optical sound is being reproduced. This extends the life of the head and prevents scratching of the photographic sound track.



FIG. 6. A rotary switch is mounted below the projector control panel as shown here. By means of the switch the output from either the magnetic or optical preamplifier may be selected to feed the program line.



### Equipment Performance

The flutter specification to which the TP-6 Projector is tested for photographic reproduction averages 0.15 percent. Tests were conducted to determine what effect the alteration of the filter system, and the frictional drag imposed on the film by the reproducing head had on the percentage of flutter. Flutter readings were made using 3000-cycle test film with the film path

altered for magnetic reproduction. The reproducing head was out of contact with the film. Results showed that the slight change in location of the damping roller assembly did not change the flutter reading. Measurements made using magnetic test film indicated a total flutter content of 0.2 percent—a slight but insignificant increase, which results from the drag of the head on the film.

The SMPTE multifrequency test film was played through the system and the output was essentially flat ( $\pm 2$ db) from 50 cycles to 7000 cps (see Fig. 7). The limitations on the response at both ends of the frequency spectrum are due to the geometry of the magnetic pickup head. The small size causes some limitation on the low-frequency response for two reasons: one, the width of the core structure becomes small compared to the recorded wavelengths; and two, there is a secondary gap formed between the mumetal shield and the pole pieces which causes a lowering of the sensitivity of the head in the region of 100 cps. At the other end of the frequency spectrum, the response is somewhat limited by the effective gap width of the head.

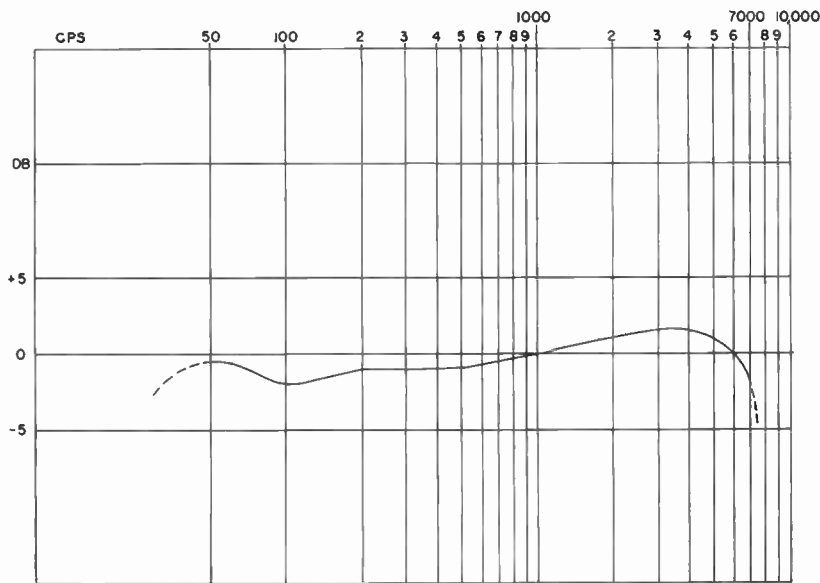

FIG. 7. Frequency response curve of the system determined using SMPTE multifrequency test film.

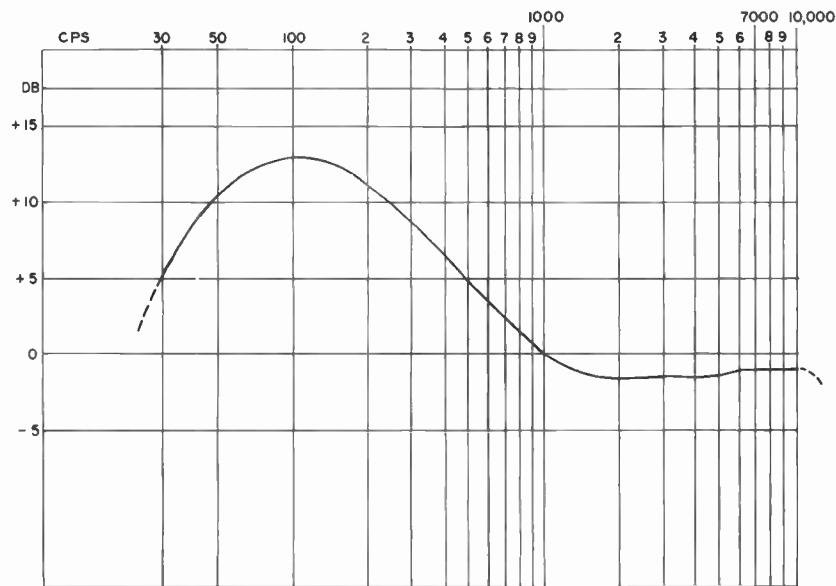

FIG. 8. Frequency response curve of magnetic sound preamp required for recording equalization.

The frequency response required of the preamplifier in order to equalize for the recording characteristic, head losses, etc., is shown in Fig. 8. In order to obtain good signal-to-noise ratio in the system, hum pickup in the leads from the head to the amplifier was eliminated by housing them in a ferro-magnetic conduit. Direct-current filaments are used in the first stage of the amplifier and a hum adjusting circuit is used for the succeeding ac filaments in the remaining stages. Other standard precautions against hum and microphonic pickup are also used. The result of these efforts is that a signal-to-noise ratio of better than 50 db has been obtained in the system.

The over-all maximum gain of the amplifier at 400 cps is 95 db which is sufficient to obtain an output level of +18 dbm from SMPTE 400-cycle level set film. An interstage gain control is provided for operation at a lower output level although (as in all interstage gain controlled amplifiers) operation at too low an output level will result in degradation of the signal-to-noise ratio. The power required, which is normally supplied by an associated power supply, is 5 volts dc at 0.3 amperes, 6.3 volts ac at 0.6 amperes and 230 volts dc at 10 milliamperes.

### Increase Program Versatility

The availability of the new kits to modify TP-6 and TP-16 Series Projectors encourages more extensive use of magnetic sound on film in the television industry. Reproducing facilities can now be installed in operating film chains with a minimum interruption of service. Together with new designs recently introduced in magnetic sound cameras these kits provide the basic elements of a high-quality-sound system which will evoke many new programming ideas.



FIG. 1. This is the RCA Type BTA-50G "Ampliphase" Transmitter. Remote control system described in the article is ideal for this transmitter.

## REMOTE CONTROL OF THE 50-KW AM "AMPLIPHASE" TRANSMITTER

*Special Consideration of Reliability, Stability, Duplication of Exciters, Meter Repeating, Local/Remote Transfer, and Building Requirements Are Necessary for 50-KW Remote Control Operation*

*by C. J. STARNER, Broadcast and Television Engineering*

During the design of the "Ampliphase" Transmitter unattended operation\* was thought to be a definite possibility in the near future, consequently emphasis was placed on the features listed below, considered of prime importance for unattended operation:

1. Utmost reliability;
2. Duplication of relatively inexpensive low-level equipment;
3. Maximum circuit stability;
4. Adequate meter repeating;
5. Provision for easy local/remote transfer; and
6. Reduced building requirements.

### Utmost Reliability

Reliability was considered a prime requirement in the BTA-50G, since the absence of immediately available remedial measures makes any malfunction a matter

\* Recent FCC rule changes permit remote control operation of 50-kw AM transmitters.

of serious concern. One way of minimizing outages is to minimize the number of components subject to failure. If a component such as a transformer is bulky and expensive, a standby duplicate becomes equally expensive and space consuming. One approach then is to use a system wherein a large number of components are small and can economically be provided with standby components. It was felt that 60-cycle equipment, such as contractors and relays, had sufficient inherent reliability that proper selection and adequate factors of safety would result in an absolute maximum of reliability in this area.

The "Ampliphase" System of modulation, with its absence of bulky components, is well suited to this approach to reliability. Figure 2 shows that when the modulator section is duplicated, the system reduces to only three straightforward rf amplifiers, plus a small driver regulator unit. System operation is such that normal and even

heavy overmodulation does not impose higher than carrier voltage duty on high-power tank components and tubes.

### Duplicate Modulator Exciters

The output power level of the BTA-50G Exciter Modulator is of the order of three watts and all components are small and relatively inexpensive. Therefore, duplication becomes economically feasible and allows the inclusion of a standby modulator unit as a basic part of the transmitter.

Figure 3 illustrates an exciter modulator unit of the BTA-50G. This is a completely self-contained unit, including all dc supplies. Functionally, it provides a phase-modulated signal for the following rf stages. Thus, the use of duplicate units provides replacement of the entire low-level section of the transmitter in the event of any malfunction of the operating unit.

Figure 4 illustrates, in functional form, the cross switching provided to permit



either push-button or remote transfer from operating to standby unit. The transfer, when initiated, is automatically sequenced, and results in only a momentary loss of carrier. During the transfer, dc power remains on the transmitter.

### Maximum Circuit Stability

Extreme circuit stability was considered a must in the BTA-50G. To a great extent this is a function of an adequate safety factor and the considered selection of components. In addition to this rather fundamental fact, stability is a function of careful attention to circuit bandwidths, and to avoidance of critical adjustments. Stability is provided by a combination of low kva. to kw ratios in all circuits, and by the use of broadly tuned band-pass coupling techniques. Neutralization of the final amplifiers is made completely broadband by the use of a special transformer type of neutralizing circuit illustrated in Fig. 5. Neutralization is effective over the entire broadcast band, and also up to approximately 2.5 mc.

### Adequate Meter Repeating

Provision is made in the Type BTA-50G for repeating all necessary meter readings at the remote operation point. Sufficient information is available from these repeat indications to comply with FCC regulations, to check operation, and to a limited extent, to anticipate and diagnose possible transmitter troubles.

Provision was made to repeat the total plate current, output plate voltage, driver plate voltage, carrier level, and both output cathode currents. The latter two readings can be used to indicate to the remote point what remedial measures should be initiated, that is: transfer of exciter modulators, transfer of crystals, reduction of power, or dispatch of maintenance personnel.

### Remote to Local Bus Transfer

The "Ampliphase" Transmitter may be operated either locally or remotely. Operation of a single transfer switch, located in the rear of the power cubicle, serves to transfer necessary operational functions such as transmitter start, plate power, etc., from a local control bus to a remote control bus. Figure 6 illustrates the remote control bus ladder diagram.

It can be seen that when the transfer switch is in the *remote* position the normal daily operational control functions are brought out to terminals for connection to the remote operating point, permitting the remote operator to have full control of the transmitter. When the transfer switch is in the *local* position, however, control of

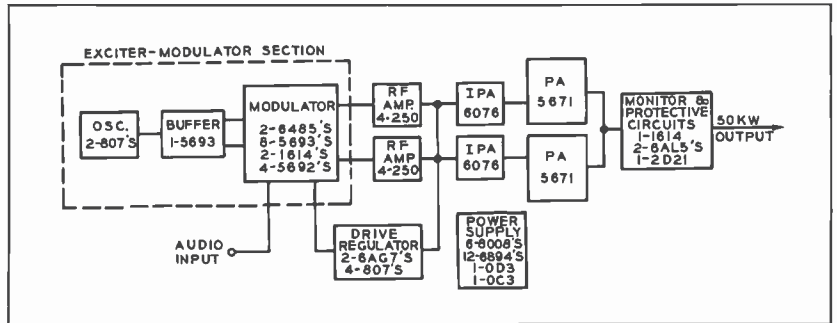

FIG. 2. An over-all block diagram of the "Ampliphase" Transmitter is shown here. Note that high-power modulation components are not needed in the "Ampliphase" system of modulation.

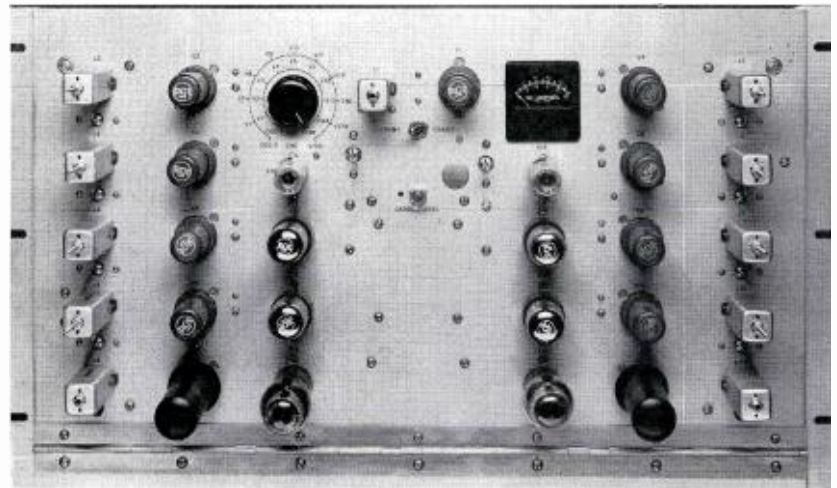

FIG. 3. The self-contained exciter-modulator section of the "Ampliphase" Transmitter is shown here. Each BTA-50G comes equipped with two of these units, thus one is always on standby.

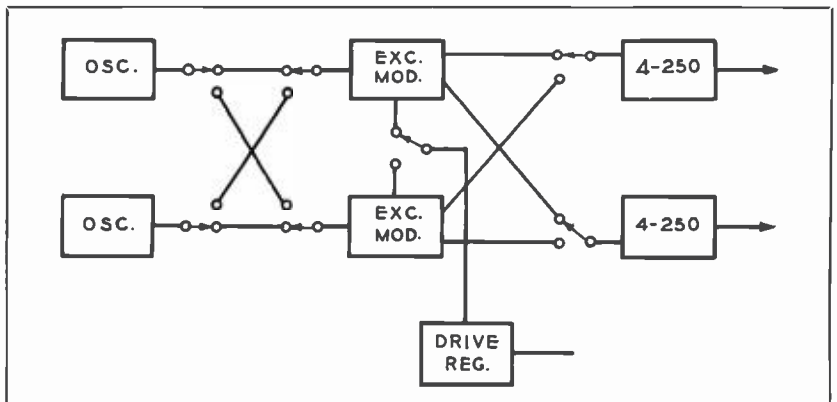

FIG. 4. Cross switching of exciter-modulator units is provided to permit either push button or remote transfer from one unit to the other. DC power remains on transmitter during switching, and automatically sequenced transfer results in only momentary loss of carrier.

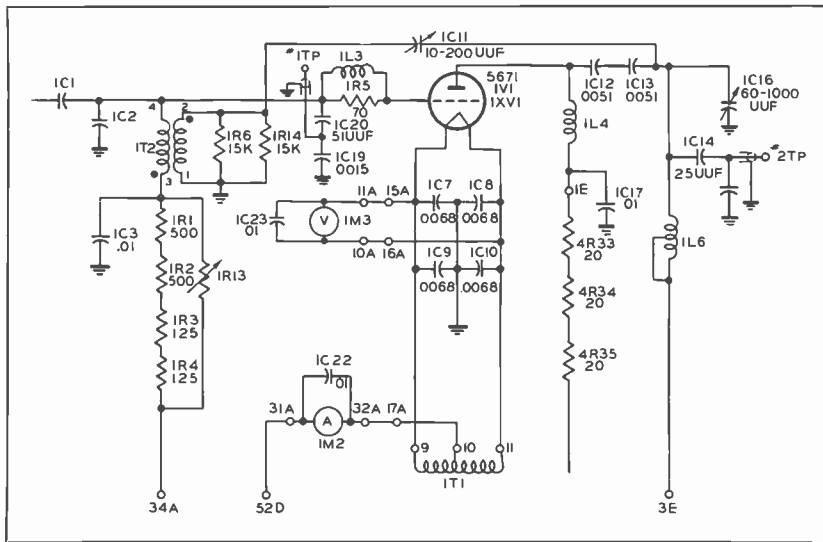

FIG. 5. This is the final amplifier circuit showing the special broad-band neutralizing transformers. Neutralization is effective over entire broadcast band and up to approximately 2.5 mc.

the transmitter reverts to the local operator, and the remote operating point cannot initiate operation or countermand the local operator. This permits local check-out, maintenance, or trouble shooting without endangering personnel by inadvertent operation from the remote point.

### Control of Power Output

Carrier level power output in the "Ampliphase" System is controlled at the exciter modulator level by changing the phase angle between the two channels. Each exciter modulator has its own carrier level control and each is adjustable from the remote operating point, thus supplying standby for this operation. Figure 7 shows a BTA-50G Exciter Modulator equipped for remote control. The front-panel-mounted motor operates (through a friction clutch) a potentiometer which changes the phase angle between the two channels, varying the carrier level power. Positive mechanical stops limit this power variation to a value of approximately plus and minus ten percent.

### Reduced Building Requirements

For unattended operation a 1-story structure with a floor area of 300 square feet would be sufficient to house the "Ampliphase" Transmitter. This provides space for station spares and a small work area. A simple concrete block structure on a concrete slab would fulfill these simple requirements.

The main plate transformers are located outside the building, eliminating any possible fire hazard. These are oil-insulated units requiring only an overhead rain shield and an intruderproof fence. Since all necessary air filters are integral to the equipment, small louvered openings are sufficient for intake and exhaust air.

The transmitter is designed to operate in an ambient temperature ranging from plus or minus 5 degrees to 45 degrees; consequently, in most locations no heating or cooling equipment is required, other than that necessary for maintenance of personnel comfort.

### Transmitter Control

All necessary operational and transfer functions can be controlled from a suitable 10-function remote control equipment. Figure 8 illustrates the use of the RCA remote equipment in conjunction with the transmitter. The terminals, shown at the left, are those of the remote control unit (located at the transmitter) and the terminals at the right are those of the transmitting equipment. The remote equipment signal which initiates the transmitter func-

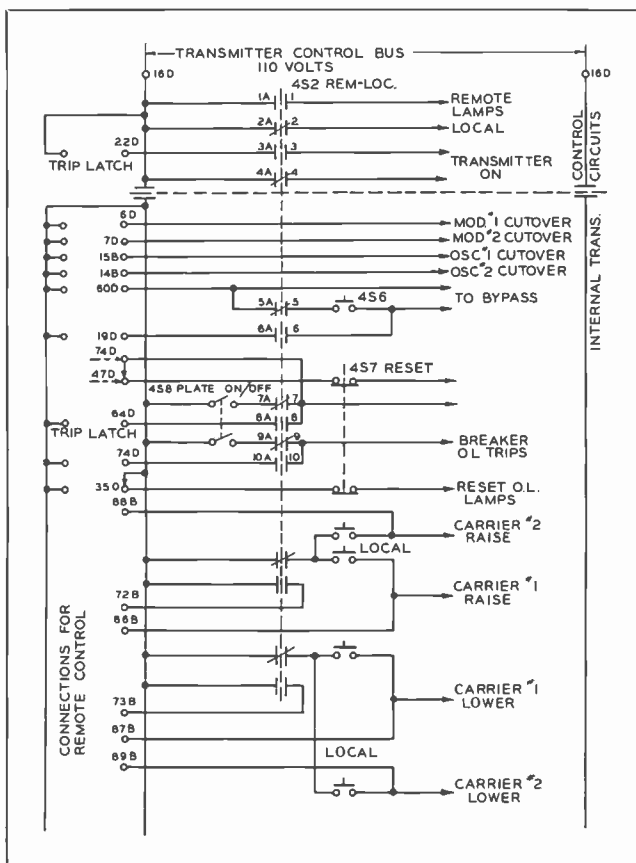

FIG. 6. Built-in remote control provisions of the BTA-50G are shown in this diagram of the internal remote control ladder bus. Operational functions are easily transferred to this remote control bus by a single transfer switch.



tions are momentary impulses (not maintained) whereas certain transmitter functions require maintained contact circuits for proper operation and auxiliary relays are used to perform these functions. These auxiliary relays are of the trip-latch type whose status can be determined by an impulse signal. A momentary signal applied to either the raise or lower terminals of position No. 1 will reverse the status of the auxiliary trip-latch switch, causing the contacts across the transmitter terminals 17D and 22D to reverse their status. These contacts are in parallel with the transmitter "START" Switch and will thus start and stop the transmitter.

Positions No. 2 and No. 3 will, in a like manner, allow choosing either the duplicate modulator exciters or duplicate crystal oscillators. No auxiliary relays are required since these require only momentary signals for operation.

Position No. 4 controls two functions, Plate TD and Overload Reset. Both of these functions are performed by a momentary signal, with relay 7K1 performing in turn two functions associated with the overload reset. These are: (1) reset of overload indicator locating lamps and (2) release of the overload lockout relay.

Position No. 5 controls application of plate power to the transmitter through a trip-latch relay, 7K1, required for maintained contact operation.

Positions No. 6 and No. 7 provide carrier level control of the transmitter. The selection of position 6 or 7 is determined by the exciter modulator that has been selected at positions 2 and 3.

Position No. 8 provides a means for remotely switching to a lower power for either 50/10-kw operation, or to 20 kw (approximately) for emergency use. This is an optional feature with this transmitting equipment, which can be accommodated in an 11-function remote equipment.

Positions No. 9 and No. 10 are additional control functions available as desired by the customer.

#### Remote Control for Any Transmitter

Inclusion of standby components, circuit stability, repeat metering, and easy local-to-remote transfer are all inherent characteristics of the "Ampliphase" Transmitter which facilitate remote control operation. In fact, provisions for remote control are now a practical requirement for all types of AM transmitters.

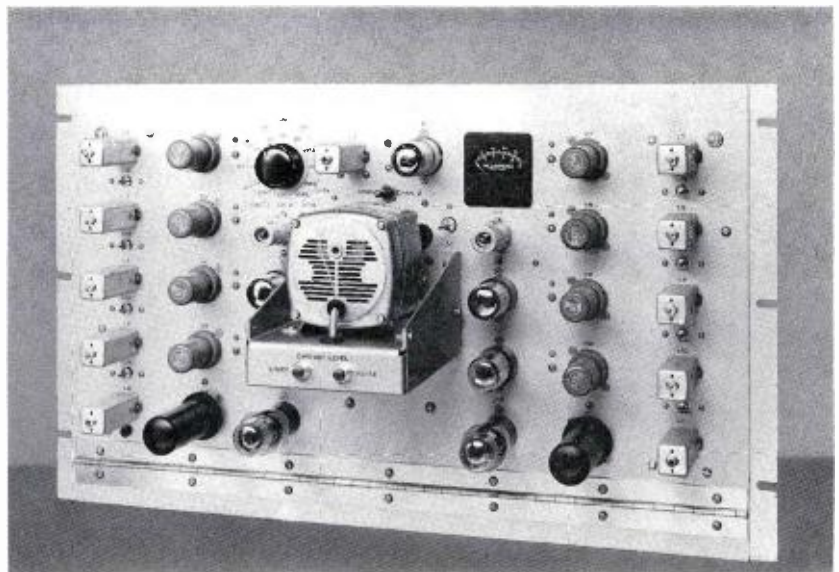

FIG. 7. Carrier level (power output control) is varied from a remote position with a friction clutch motor mounted on the exciter-modulator as shown here. Power variations are limited to  $\pm 10$  percent by positive mechanical stops on the motor.

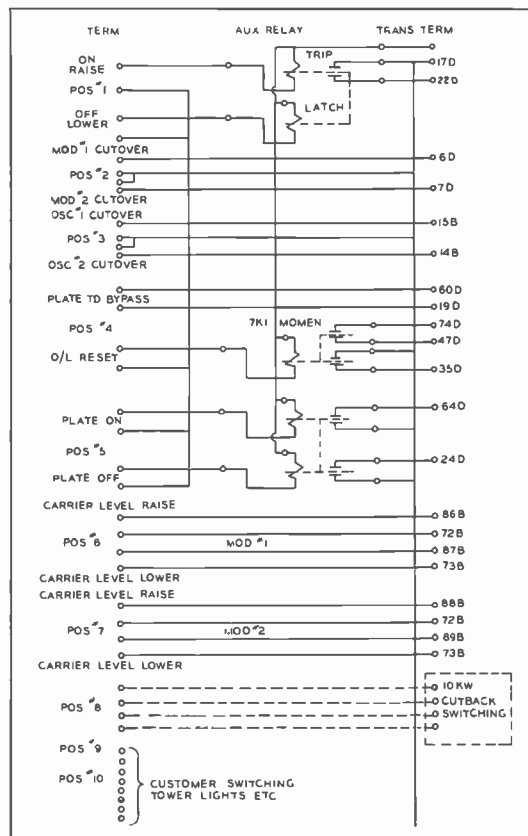

FIG. 8. This is a typical remote control system diagram for use with the BTA-50G Transmitter. The right side of the drawing shows control functions at the transmitter while control functions from the remote location are shown at the left.

# NEW FM TRANSMITTER AND MULTIPLEX EQUIPMENT

**5-KW FM Transmitter, Type BTF-5B, Designed for Multiplex and Conventional FM Operation; Exciter and Subcarrier Generator Designed for Converting Existing Transmitters to Multiplex Operation**

by A. H. BOTT, Broadcast and Television Engineering

FIG. 1. Front view of the BTF-5B FM Transmitter. Cabinet on the left houses the PA stage. Cabinet on the right houses the IPA, the BTE-10B Exciter, and enough space is provided for mounting the BTX-1A Subcarrier Generator.



Over 500 FM stations are now on the air and more are applying. Background music service has become a very profitable programming concept for many stations, and now stereophonic programming may enter the picture. Multiplexing offers a station added sources of revenue by enabling it to offer several different types of programs.

In order to fill the broadcasters need for economical, easy to operate multiplex equipment, RCA has developed a new FM equipment line. New installations can be equipped from microphone to antenna, and existing installations can be converted to multiplex operation by adding individual units. For new installations, the Type BTF-5B FM Transmitter is a complete unit which, with the simple addition of a Type BTX-1A Subcarrier Generator, becomes a multiplex transmitter. For existing installations, the BTE-10B Multiplex Exciter and the BTX-1A Subcarrier Generator are ideal for converting most existing transmitters for multiplex operation.

## A 5-KW FM Transmitter

To assure outstanding multiplex performance RCA offers the Type BTF-5B FM Transmitter. This 5-kw unit has been designed for multiplexing, and it will also offer outstanding conventional FM performance. The BTE-10B Exciter is used to drive the IPA stage, where a single 7034 tube produces 250 watts (see Fig. 2). The PA stage is composed of a single 4CX5000A tube which produces the 5000-watt output. Only two tubes are used beyond the exciter to produce the 5000-watt FM signal.

Dry disc rectifiers are used in the variable screen grid power supply for both IPA and PA. The high-voltage supply is made up of six 8008 mercury vapor tubes, which also feeds both stages. The exciter and subcarrier generators both have self-contained power supplies.

The subcarrier generator is not supplied with the transmitter; however, space is provided in the exciter cabinet for mount-

ing the unit. The BTF-5B cabinet has been designed along the same lines as the BTA-500R/1R AM Transmitters. Colored doors are available on the BTF-5B. The exciter cabinet is attached to the PA cubicle, and another cabinet can be added to house input and monitoring equipment.

## Multiplex Transmission

Multiplexing is the simultaneous transmission of two or more separate program channels on the same rf carrier. One program will frequency modulate the rf carrier in the conventional manner; this constitutes the main program channel which broadcasts programs intended for the general public. The main channel can be received on conventional FM broadcast receivers.

An additional program channel can also be modulated on the same rf carrier; however, this second channel is selected so that it does not interfere with the main program channel. To prevent interference with



the main channel, it is necessary to transfer the subchannel program into the supersonic frequency range, and this is accomplished by frequency modulating the subchannel program on to a 30-67 kc subcarrier. This frequency modulated supersonic carrier is then used to modulate the rf carrier; thus, the main carrier contains two separate programs. As many as two subcarriers can be inserted on a single main rf carrier, and the new RCA multiplex equipment is capable of transmitting a main and two subchannels.

### Multiplex Standards

No standard subcarrier frequencies have been set at this time, however, a number of frequencies are being used. The new RCA Type BTE-10B Multiplex Exciter and the Type BTX-1A Subcarrier Generator will operate on the popular subcarrier frequencies now in use (as well as others). Frequencies now in common use are 32.5, 42, 58 and 67 kc. One hundred percent modulation of the subcarrier has been set at a frequency deviation of  $\pm 7.5$  kc. It is possible to transmit several subchannels along with the main channel, if the sum of the frequency deviations for sub and main channels does not exceed the maximum FCC limit of  $\pm 75$  kc.

Subsidiary Communication Authorization is the FCC terminology for multiplex operation, and these SCA rules limit the instantaneous frequency of the subcarrier (including frequency deviations of the subcarrier due to modulation) to a range from 20 to 75 kc. Furthermore, the modulation of the (main) rf carrier by the subcarrier, or the subcarriers shall not be more than 30 percent of the maximum deviation allowed on the rf carrier, which is  $\pm 75$  kc. In other words, the maximum subcarrier swing of the main rf carrier cannot exceed  $\pm 22.5$  kc. These rules are not considered final, and may be changed in the future.<sup>1</sup>

### Receiving Equipment

The FM receivers used by the general public will, as mentioned before, not be noticeably affected by the presence of the supersonic subcarriers or their modulation. To receive the subchannel, or the subchannels, special receiving equipment that incorporates provisions for detecting the subcarrier will have to be used. RCA carries a line of these special multiplex receivers and thus provides a complete system.

### How Multiplexing Is Used

The program modulated onto the subcarrier will often consist of background music; however, speech or other intelligence may be used subject to FCC approval. Tests are being conducted that may provide the answer to the feasibility of FM stereophonic broadcasting. Care has

been taken in the design of the RCA equipment to make this application possible.

### System Performance

FM broadcast multiplexing is a completely new technique to many FM broadcasters. While no new phenomena are encountered, multiplexing has a definite

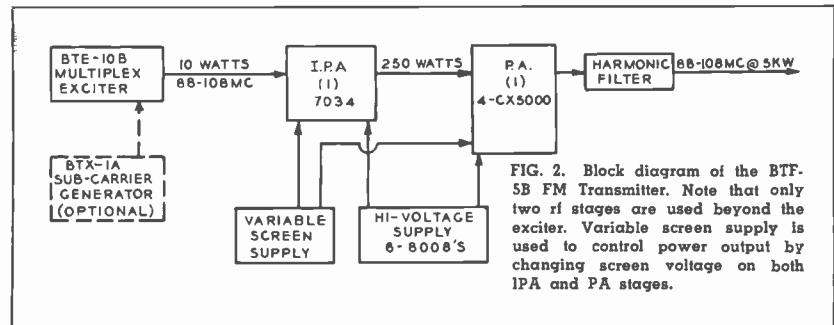
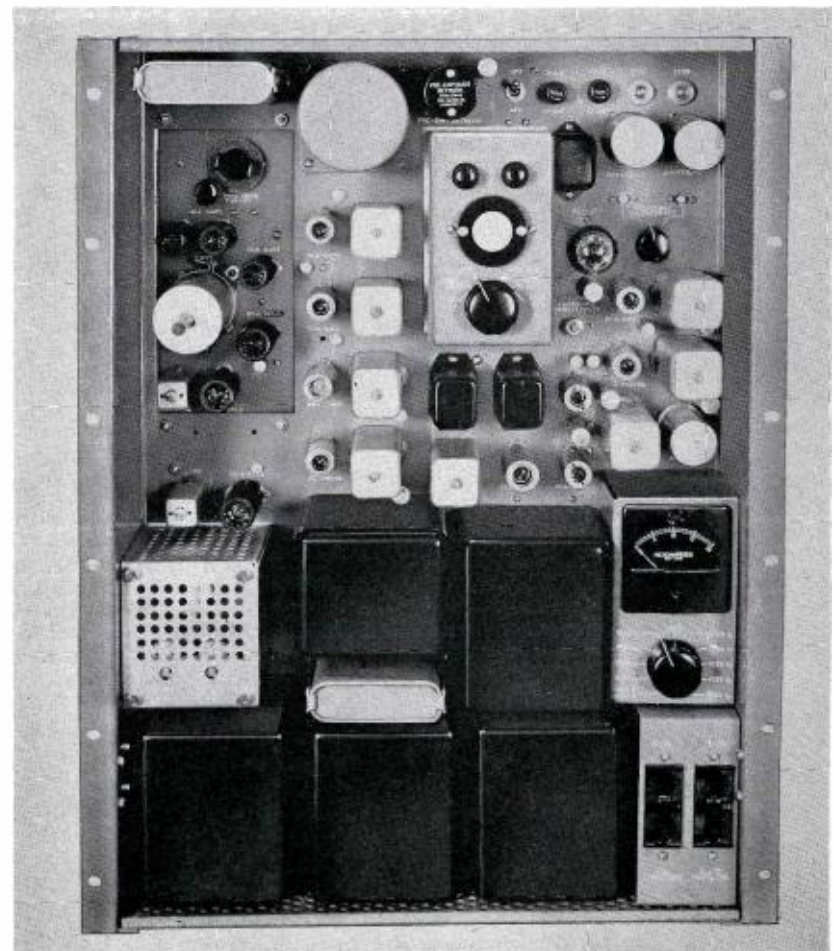
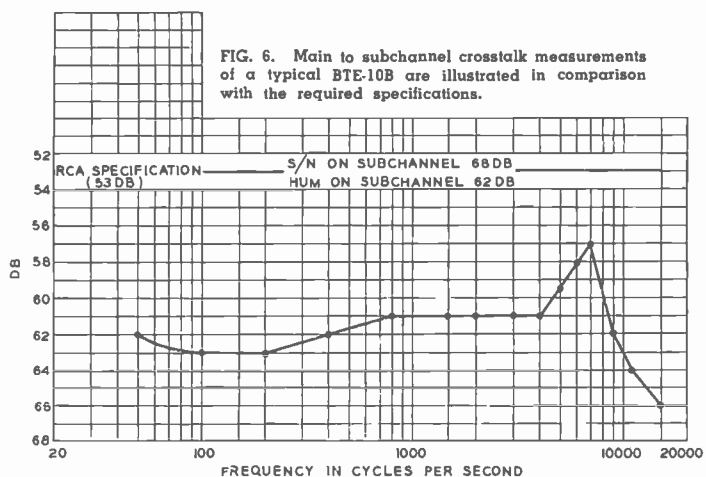
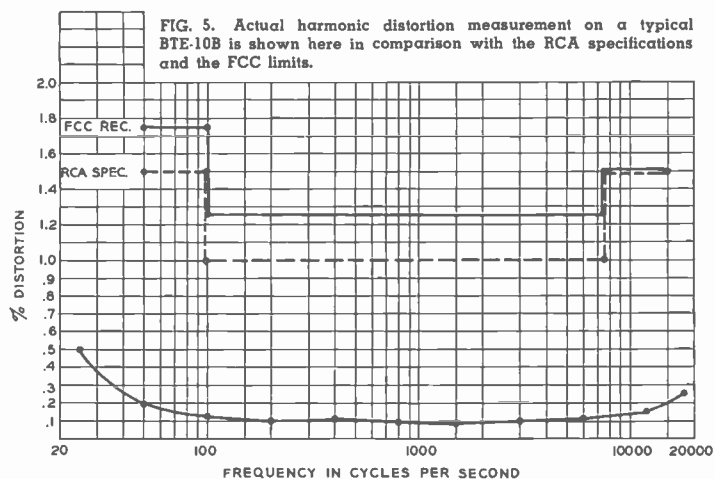
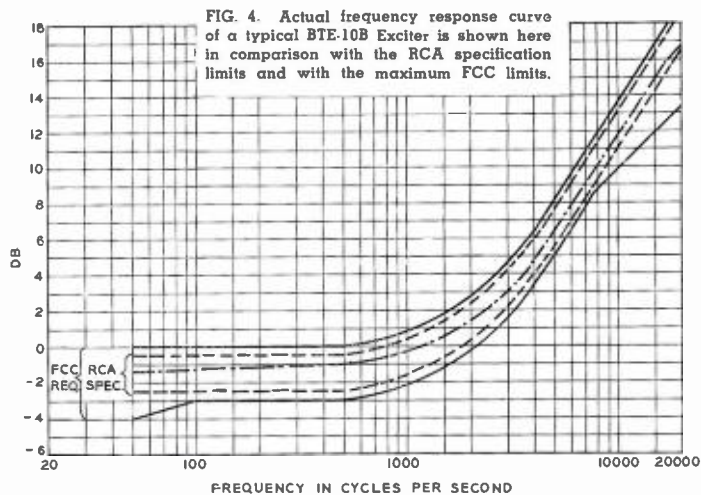

FIG. 2. Block diagram of the BTF-5B FM Transmitter. Note that only two rf stages are used beyond the exciter. Variable screen supply is used to control power output by changing screen voltage on both IPA and PA stages.

FIG. 3. Here the vertical chassis of the BTE-10B Exciter is shown. The built-in scope permits constant observation of the AFC circuits. The meter, in the lower right side, is used to check all important circuit constants.



<sup>1</sup> See Federal Communications Commission Notice of Inquiry, Docket No. 12517. Released July 8, 1958.



effect on the over-all system performance that requires a little more attention.

In conventional FM service (meaning the transmission of only one program on the rf carrier and no subchannels) there are mainly three transmitter design considerations which affect performance: (1) frequency response, (2) harmonic distortion and (3) the ratio of the wanted signal to the unwanted noise (signal-to-noise ratio, or S/N). In addition to these considerations, crosstalk between channels must be added when considering a multiplex system.

### Frequency Response

Typical performance data for frequency response is given in Fig. 4. The curve shown should be compared with RCA specifications and also with FCC requirements both of which are included in Fig. 4. It should be noted that performance is measured from 50 to 18,000 cps. Frequency response of the exciter is mainly determined by the quality of the audio frequency components used in the modulator section of the exciter. The rf circuits following the reactance tube modulator and the master oscillator have no appreciable effect on frequency response; therefore, it cannot be upset by improper tuning of the rf section. This would not have been so if very narrow bandwidth rf coils had been used. Furthermore, the exciter needs only three tuned stages to get up to the final output frequency in the FM broadcast band.

### Harmonic Distortion Measurements

Harmonic distortion is a more intricate problem. Nonlinearities of the phase vs frequency curve of the tuned circuits in connection with nonlinearities of the voltage vs current curves of the tubes creates harmonic distortion. The degree of distortion depends on the degree of nonlinearities. The distortion can differ greatly at different audio frequencies; and it is, of course, dependent on the percentage of modulation. To a lesser degree distortion is also created by improper amplitude response of the tuned circuits, but under practical conditions this may be disregarded. Many times in addition to harmonic distortion, figures are given for intermodulation distortion. While both types are not directly interrelated they can be attributed to the same shortcoming of the components used and one is representative of the other, meaning low harmonic distortion will indicate low intermodulation distortion and vice versa. It should be



remembered that in order to get the ultimate of low distortion output from any FM transmitter (or receiver) all tuned stages should be tuned for minimum distortion employing a distortion analyzer as indicating device.

Figure 5 gives typical performance data of a BTE-10B Exciter for harmonic distortion together with the limits called for in the specifications. It must be noted that the distortion is so low that the limit of accuracy of the measuring device is in the same order as the exciter distortion.

**S/N Ratio**

The type of modulator used will determine to a large extent the signal-to-noise ratio, and S/N is practically unaffected by the rf circuits following the master oscillator. For practical reasons, noise and ac hum should be read separately using an appropriate filter to separate both components. Many times -50 db hum level is less objectionable than -60 db noise level, yet reading both with a peak VTVM would indicate -48 db signal-to-noise ratio.

FCC requirements on the signal-to-noise ratio are -60 db, and RCA specifications call for -65 db while figures for the new exciter approach -78 db noise and -75 db hum. In addition to the FM noise level an AM noise level is specified. These are not related, the latter just indicates the "cleanness" of the carrier with respect to any unwanted amplitude modulation. RCA specifications call for -50 db and figures for the exciter can be as low as -70 db.

**Crosstalk and Multiplexing**

A multiplex system will require some additional information to describe the performance of a transmitter. First, all of the above data should be obtained for the one or more subchannels. In the RCA system, subchannel performance in areas such as frequency response, distortion and signal-to-noise ratio are maintained as nearly comparable to the performance of the main channel exciter as possible.

**Reduced Crosstalk**

Finally, another consideration has to be added—intermodulation between the different channels. This is by far the most difficult problem. There are three types of intermodulation, also referred to as crosstalk: from main-to-subchannel, from sub-to-main channel, and from one subchannel to another subchannel. Intermodulation stems from the same transmitter shortcomings that cause harmonic distortion. It may easily develop because of improper

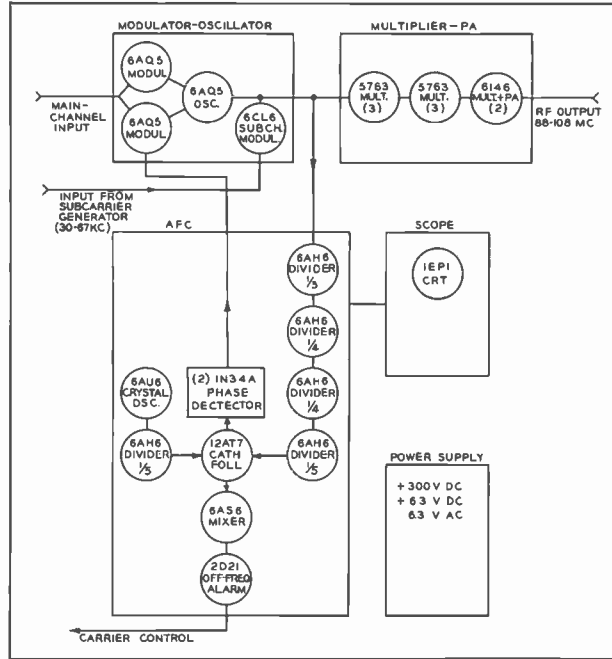
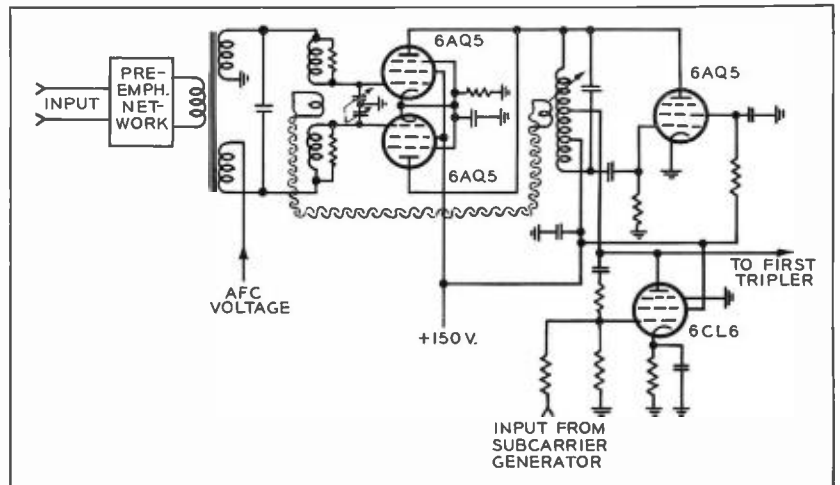

FIG. 7. Simplified block diagram of a BTE-10B Exciter. The modulator-oscillator is shown with provisions for inserting one subcarrier.

FIG. 8. Simplified schematic of the BTE-10B modulator-oscillator. The 6AQ5 balanced modulators act as variable reactances on the 6AQ5 oscillator. Subcarrier modulator (6CL6) acts in the same manner as main channel modulator.



tuning of the rf multipliers. The increased harmonic distortion might very well go unnoticed by the average listener; however, a 15 db increase of crosstalk from the same cause can be much more easily detected. In multiplex operation the transmitter has to be of excellent quality and it must be kept in better condition to work satisfactorily, and this requires better measuring equipment and test techniques.

The degree of perfection required de-

pends on the type of service to be used. In a background-music installation crosstalk from the main channel into the subchannel is highly undesirable. While in a stereophonic application this, because of the similar nature of the program in the two channels, is not as important. On the other hand background music requires only frequencies up to 6 kc, while stereophonic applications will probably require better frequency response. Typical performance

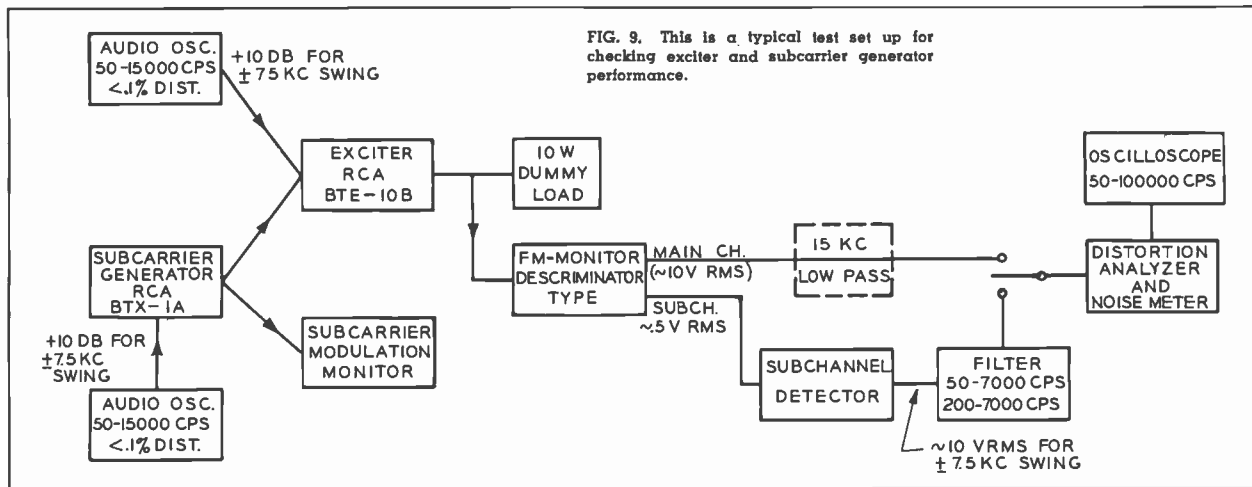

FIG. 9. This is a typical test set up for checking exciter and subcarrier generator performance.

data of main-to-subchannel intermodulation is given in Fig. 6. These figures are not exciter data but system data, covering exciter, monitoring, and detection devices. There are indications that the exciter alone is a few db better than indicated in Fig. 6.

Crosstalk from the subchannel into the main channel shows the same slight increase toward the higher audio modulating frequencies and is about 10 db better than the main-to-subchannel crosstalk. Sub-to-main channel crosstalk is almost independent of rf multiplier tuning.

#### Exciter Circuit Advantages

The Type BTE-10B Exciter in conjunction with the 250-watt IPA is used to drive a single 4CX5000 tube in the BTF-5B FM Transmitter for ordinary FM service or multiplex operation.

A block diagram of the exciter is given in Fig. 7. A simplified schematic of the modulator-master oscillator portion is shown in Fig. 8. A Hartley-type oscillator is used in conjunction with two reactance tubes for the main channel and a third reactance tube for the modulation of the subcarrier on the (main) rf carrier. This method has several marked advantages.

The push-pull modulator is highly linear resulting in very low harmonic distortion. The coupling circuit is such that each tube is almost a pure reactance, one inductive, the other capacitive. In this way, loading of the oscillator is greatly reduced giving better AFC action. Furthermore, the push-pull modulator will balance out temperature and supply-voltage changes automatically. The low AFC control voltages required assure proper operation even if the uncontrolled oscillator is off-frequency.

The subcarrier reactance tube is coupled only to a small part of the oscillator coil, since the deviation of the rf carrier by the subcarrier is rather small.

Both modulating circuits are very effectively decoupled thus minimizing the possibility of crosstalk between the two channels.

#### Automatic Frequency Control

The AFC circuit with associate off-frequency detector has recently been described.<sup>2</sup> The circuit used in this exciter is essentially the same except for a simpler (due to simpler circuit requirements) divider arrangement and the use of miniature tubes throughout.

The circuit used has a long record of very reliable operation. Since a phase detector is used to develop a control voltage the system is, strictly speaking, an automatic phase control system that tries to establish and maintain a phase lock between the reference and the derived signal. Therefore the stability achieved is the same as the stability of the reference source.

The precise control achieved this way is normally traded against a very limited range of control. This limitation is overcome by the use of the off-frequency circuit which extends the pull-in range of the control circuit to  $\pm 300$  kc (at the final frequency) and at the same time provides a safeguard against uncontrolled and possible off-frequency operation.

In order to simplify adjustment and maintenance of the AFC dividers a monitor oscilloscope is permanently incorpo-

<sup>2</sup> "A New Visual and Aural TV Exciter." *Broadcast News*, Vol. No. 99, February, 1958.

rated into the exciter. A switch permits instantaneous checking and adjustment of all five dividers and a check of the control action of the phase detector. All waveform displays are in form of Lissajous figures with the advantage that lock-in of the dividers can very easily be observed. Furthermore, this type of display needs no synchronization or any other adjustment. All checks can be made during operation without upsetting the AFC circuit in any way.

A built-in meter can be switched to read the following voltages, currents and power: modulator cathode current, second and third multiplier grids, PA cathode and plate current, AFC control voltage and plate voltage. The rf multiplier and PA use single tuned circuits, thus making adjustment simple. The final amplifier of the exciter is a doubler.

#### Exciter Power Supply

Semiconductor rectifiers are employed throughout the exciter power supply. One bridge-type germanium rectifier is used for the high-voltage supply and a full-wave silicon rectifier for the modulator oscillator filament. The exciter can be operated from any single-phase source having a voltage of 197 to 251 volts, or 106 to 128 volts ac at 50/60 cps.

One circuit breaker is provided in the high-voltage supply and one in the ac input. They both serve at the same time as master and stand-by switches. There is a separate connection for the 117-volt crystal oven heater supply. The oven heater should be energized continuously. Each circuit (one operational and one spare crystal) is protected by  $\frac{1}{4}$ -amp fuses.



### Monitoring Multiplex Signals

The method of measuring several multiplex parameters will now be discussed. The measuring arrangement is shown in Fig. 9. Care should be taken to select the test equipment to suit this application. Both audio generators should be of low initial distortion, preferably 0.1 percent or less.

To monitor the subchannel a multiplex monitor can be used with the subchannel signal fed directly in the subcarrier adapter section of the monitor. The FM monitor and subcarrier detector will be contained in the FM multiplex monitor. However, should this unit not be on hand a standard FM monitor of the discriminator type may be used together with an adapter from the multiplex receiver.

The filter shown in Fig. 9 is not absolutely required, but is very useful in eliminating unwanted components, such as hum. As waveform monitor, any oscilloscope good to 100 kc may be used. Frequency response and distortion as well as signal-to-noise on the main channel can be measured the usual way. Similarly, these parameters can be measured for the subchannel.

To measure signal-to-noise ratio on the main channel with subcarrier modulation present, the filter must be used to eliminate the subcarrier. An electronic filter is very suitable for this purpose.

### Crosstalk Measurements

Main-to-subchannel crosstalk is where the measurement of special multiplex parameters should begin. To set the reference the subchannel should be modulated 100 percent ( $\pm 7.5$  kc deviation) with a 400-cps tone. Set the distortion analyzer for noise measurement, and adjust the meter deflection to 0 db. The filter should be set to pass a band from 50 to 15,000 cps (see Fig. 9).

Now remove the subcarrier modulation and apply modulation to the main channel using a number of frequencies from 50 to 15,000 cps, adjusting each frequency to 85 percent modulation if one subchannel is used. (If two subchannels are used, the main channel should be modulated 70 percent instead.) Read the crosstalk for all frequencies on the distortion analyzer.

Next, modulate again 400 cps at 85 percent to the main channel, and carefully adjust all multiplier stages of the BTE-10B exciter to give a minimum crosstalk reading. Make sure not to detune the tuned circuits too much. Also *touch up* the monitor tuning (rf and i-f coils, and dis-



FIG. 10. All operating adjustments on the BTX-1A Subcarrier Generator are accessible from the front of the unit as shown here. Again the convenient built-in oscilloscope can be used to observe operation of AFC circuits. The author is shown checking divider circuits.



FIG. 11. When used with two subcarrier generators, the BTF-5B is housed in three cabinets as shown above. (Normally the BTF-5B is housed in two cabinets, see Fig. 1.) All cabinets for this transmitter are available in a choice of red, blue, green, or umber-gray doors.

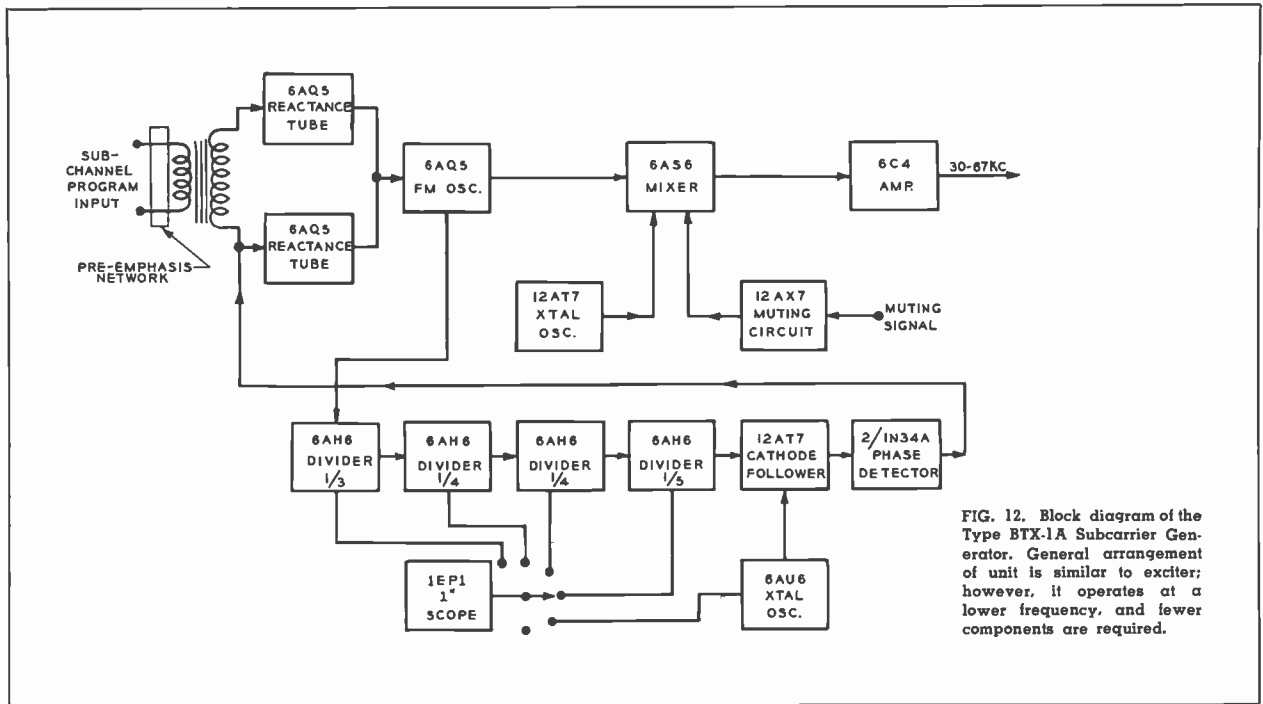

FIG. 12. Block diagram of the Type BTX-1A Subcarrier Generator. General arrangement of unit is similar to exciter; however, it operates at a lower frequency, and fewer components are required.

criminator), and make sure that the monitor and separate subcarrier adapter, if used, are fed with the right amplitudes and not overdriven.

If necessary, repeat the steps indicated above, however, slight adjustment of the first tripler coil should correct any possible excessive crosstalk on 6 kc. Make sure by observing the waveform oscilloscope that the meter indication on the distortion analyzer represents the components required. Certain beat frequencies generated in the monitor may give a false impression. It should be noted that the above adjustment is greatly simplified because only three tuned circuits may contribute to crosstalk. In some instances it may be advantageous to slightly shift the modulator grid tuning capacitor to give 2 to 3 db better crosstalk reduction. The subcarrier modulator itself requires no tuning.

In a similar way sub-to-main channel crosstalk will be measured. This time the 0 db reference is 100 percent modulation ( $\pm 75$  kc deviation) by a 400-cps tone on the main channel. This modulation then is removed and tones from 50 to 6000 cps applied to the subcarrier generator, giving 100 percent ( $\pm 7.5$  kc) modulation on the subchannel. Slight crosstalk may result from improper balancing of the main channel modulator tubes. Therefore, the modulator grid tuning, after initial setting for

maximum swing should ultimately be tuned for minimum sub-to-main channel crosstalk. This setting requires only a very slight change. The exciter multiplier tuning has practically no effect on sub-to-main channel crosstalk.

From the above, the last measurement has become quite obvious. To measure possible intersubcarrier crosstalk one proceeds in the same way, setting a reference level for the channel in which crosstalk is being measured by first modulating it with a 400-cps tone at 100 percent modulation ( $\pm 7.5$  kc).

### The Subcarrier Generator

Although the Type BTX-1A Subcarrier Generator has already been discussed in conjunction with the exciter, it deserves some separate description. Basically, the exciter and subcarrier generator are of similar design (compare Fig. 7 with Fig. 12); however, due to the lower frequencies encountered in the subcarrier generator fewer components are required.

Operation is similar to the exciter. Exact frequency of the subcarrier is determined by beating the FM exciter master oscillator frequency with that of a crystal oscillator, the resultant signal will be at the subcarrier frequency selected in the 30 to 67 kc range (see Fig. 12).

Background-music operations often use supersonic control tones. Interference between main and subchannel occurs when the control tones are transmitted. To prevent this interference, a muting circuit is used in the subcarrier generator which will cut off the subcarrier when control tones are being transmitted.

The Type BTX-1A Subcarrier Generator, when combined with the BTE-10B Multiplex Exciter, can be used to convert existing transmitters to multiplex operation; however, the type of transmitter used will have a great effect on the final signal. All exciter and subcarrier generator specifications will only hold true to the output of the exciter, except when used to drive the RCA Type BTF-5B FM Transmitter, then the over-all transmitter performance will meet specifications.

### Conventional FM Operation

Since this new transmitter and exciter have been designed to meet the more stringent requirements of multiplex operation, they will obviously offer superior performance for single channel operation. Stations now in operation can use this equipment for the present, and later if multiplex operation becomes desirable all they need to do is add the subcarrier generator.



# INTRODUCTION TO JUNCTION TRANSISTORS

## PART I—Basic Transistor Action, and the Common-Base Amplifier

by R. N. HURST,<sup>1</sup> Broadcast and Television Engineering

As transistorized equipment comes into use, the broadcast engineer will find that a new dimension must be added to his field of knowledge. Transistors—resembling tubes in some ways, differing from them in others—will put new demands on the skill and ability of the men who install, maintain, and repair broadcast equipment. To help broadcast engineers acquire this new skill, we present here the first of a series of articles to explain the fundamental behavior of junction transistors in familiar terms. In these articles, the physicists' point of view of a transistor is intentionally avoided in order to permit the reader to approach this new subject through the concepts of well-known electronic circuits.

This year marks the tenth anniversary of the invention of the transistor, which during this time has developed from an unpredictable device with sharply limited applications to a stable and reproducible element, which can be employed in a wide variety of circuits. During these years of development, RCA broadcast engineers have kept a watchful eye on this promising device. Circuits using transistors were regularly evaluated, and those meeting broadcast standards of quality were incorporated into products. Until recently, however, these products were limited to audio devices because no commercially available transistors were capable of acceptable high-frequency operation. Recently, there has been an accelerated development of new devices and techniques which promise to put the transistor into all types of broadcast equipment. Even as this is written, the forerunners of many kinds of broadcast equipment using transistors are taking shape.

Hence it is important for the broadcast engineer to know something of the characteristics of transistors: how they operate; what their limitations are; what their advantages are; and, ultimately, to become as familiar with transistor circuitry as he is with vacuum tube circuitry.

### Basic Transistor Action

A transistor may be considered as an extension of an ordinary junction diode, which consists of two pieces of semiconductor

material of slightly different composition, joined together with wire leads provided for connection to each piece. Although the difference in the chemical compositions of the two pieces is slight, the difference in their electrical characteristics is very great. To identify these different materials, one is called *P-type material*, and the other, *N-type material*. The physics of these differences is not discussed here, it is sufficient to say that a junction diode will conduct heavily if a voltage is placed across it with the P-type material positive and the N-type negative,



but will conduct only slightly if the polarity is reversed:

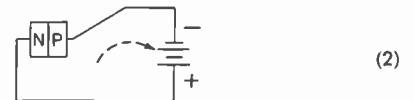

When the diode is conducting heavily, it is said to be *forward biased*; when it is conducting slightly, it is *reverse biased*.

If this diode structure is extended to include another junction, leaving the original junction reverse-biased as above, and providing a *forward bias* for the new junction diode which was formed by adding the left-most P-region, the circuit will appear as follows:

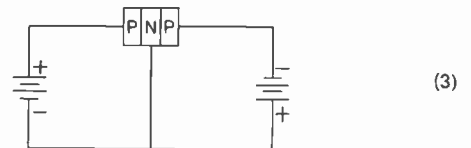

One might expect (*wrongly*) that a heavy current would flow in the forward-biased diode, a small current would flow in the reverse-biased diode, and there would be no interaction between the two diodes:

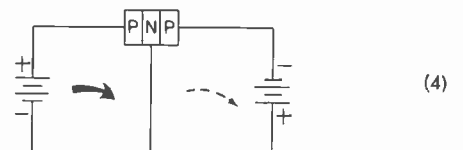

*This is not the case, however.* For the circuit shown, the forward-bias current of the left-hand diode would flow com-

<sup>1</sup>This series of articles is abstracted from a group of transistor lectures given jointly by the author and Mr. A. C. Luther. The author wishes to acknowledge the fact that many of Mr. Luther's valuable contributions to the lectures have been retained in these articles.

pletely through both junctions, except for a small current which would flow as shown in this sketch:

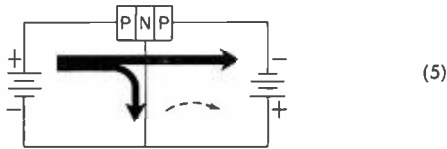

This unexpected behavior, which is observed only if the center region is thin, is the basis for transistor action.

Since the left-hand P-region emits current into the transistor, it is called the *emitter*. The middle region (the N-region here) through which the emitter current passes is called the *base*. The right-hand P-region, which collects the current emitted by the emitter, is called the *collector*.

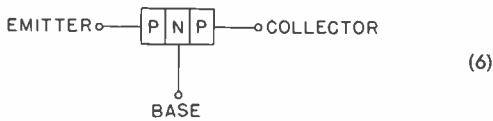

A transistor constructed in this manner (as a "sandwich" of N-type "meat" and P-type "bread") is called a *PNP Transistor*. By reversing the "meat" and the "bread," another arrangement is possible:

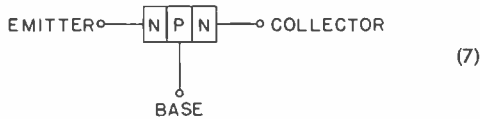

This arrangement is called an *NPN Transistor*. The major difference between the two is that the various voltages applied to a PNP transistor must be reversed for an NPN transistor.

In schematic diagrams, a PNP transistor is symbolized in this way:

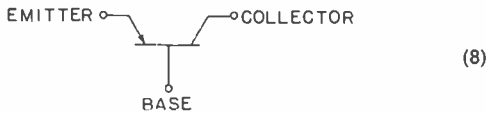

and an NPN transistor this way:

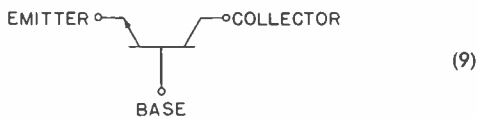

You will notice that both NPN and PNP transistors exhibit left-to-right symmetry: that is, the emitter and collector of a given transistor are both made of the same material, and apparently connected to the base in the same way. It is reasonable to ask whether it makes any difference which of the outer regions is the emitter and which the collector. In some transistors, called *symmetrical* transistors, it makes no difference.

In most transistors, however, the emitter and collector regions are manufactured differently. It is this difference which determines the proper naming of these regions. Regardless of this difference, a typical small transistor may usually be made to operate in a very limited manner with emitter and collector leads interchanged.

### Transistor vs Vacuum Tube

The transistor, being an amplifying device, bears a resemblance to a vacuum tube in that the three "elements" of a transistor correspond (approximately) to the three elements of a triode tube:

| Transistor | Vacuum Tube |      |
|------------|-------------|------|
| Emitter    | Cathode     | (10) |
| Base       | Grid        |      |
| Collector  | Plate       |      |

This correspondence between transistor and vacuum tube can be used to produce the following equivalent symbols:



One should not infer, however, that these equivalences are anything but approximate. For example, consider the difference between a grid and a base. A grid, in normal negative-biased operation, draws no current. The total cathode current flows in the plate circuit:

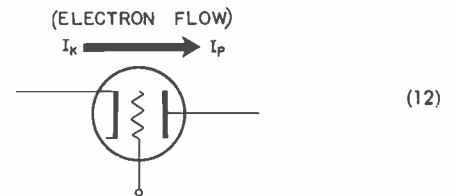

It was stated above, however, that the emitter current in a transistor divides between the collector and the base, so that the base has an appreciable current flowing in it:

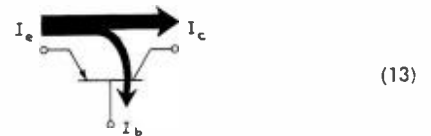

Since the current that flows (for a given voltage) is an indication of the impedance of a circuit, the fact that the base draws current while a grid does not leads to the conclusion that the impedance seen looking into a base would be very much smaller than the impedance seen looking into a grid. The conclusion is correct; a typical vacuum tube, it is well known, has a grid impedance of several megohms,

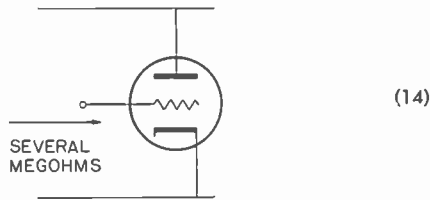

while a typical transistor may have a base impedance less than 2000 ohms:

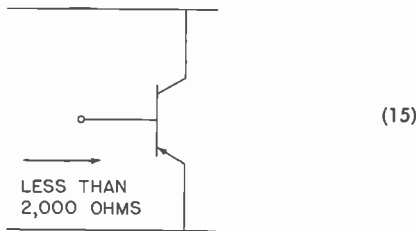

### Definition of Alpha and Beta

Although sufficient current flows in the base circuit to make the base appear as a low impedance, this base current represents only a small portion of the emitter current—approximately two percent in a typical transistor. Remaining 98 percent appears in the collector circuit. This current division is used to define an important transistor parameter called *alpha*. If 98 percent of the emitter current of a certain transistor flows in its collector, the transistor has an alpha of 0.98. Mathematically, it is stated:

$$\alpha_{DC} = \frac{I_c}{I_e} \quad (16)$$

Since  $I_c$  (dc collector current) and  $I_e$  (dc emitter current) are bias currents, their ratio is called *dc alpha*, hence the dc subscript. The more frequent use of the word alpha refers to a ratio of signal currents (where  $i_c$  and  $i_e$  are signal currents in the collector and emitter, respectively):

$$\alpha_{AC} = \frac{i_c}{i_e} \quad (17)$$

The word alpha as used herein always refers to the ratio of signal currents, unless there is a statement to the contrary. It is interesting to note, in passing, that both definitions give almost the same value for alpha.

Since the collector current is always a little less than the emitter current, alpha will always be a little less than one. Therefore, a transistor will offer loss instead of gain for a *current* signal impressed on the emitter and observed at the collector:

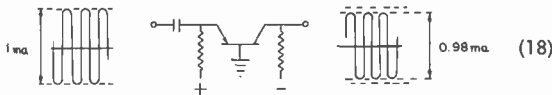

Nonetheless, useful arrangements can be made using this circuit, even though it does not give us a *current* gain. Some of the ways of using this configuration, which is called the *grounded-base configuration*, are discussed later in this article.

How, then, is current gain obtained? It is obtained by controlling the base current (two percent in the foregoing example) by applying a signal to the base. The base current, when controlled by a small fluctuating (signal) current, causes a corresponding fluctuation in the much larger emitter current, thereby causing the same fluctuation in the collector current:

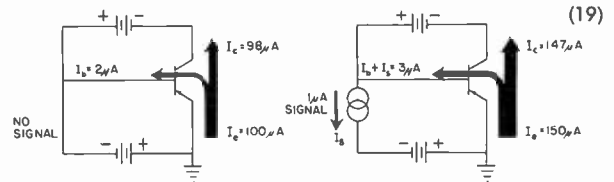

Since the small signal-current introduced in the base circuit causes a larger signal-current to appear in the collector circuit, we say that a *current gain* has taken place.

The current gain obtained here is clearly the ratio between the collector current and the base current. This current ratio is another important transistor parameter, and is called *beta*. Mathematically, it is stated:

$$\beta_{DC} = \frac{I_c}{I_b} \quad (20)$$

This ratio is called *dc beta*, for reasons similar to those given for dc alpha. More frequently, the word beta refers to a ratio of *signal* currents:

$$\beta_{AC} = \frac{i_c}{i_b} \quad (21)$$

This definition of beta is the one which is used in this article unless there is a statement to the contrary.

In sketch 19, a signal current of 1  $\mu$ A in the base caused a change of 49  $\mu$ A (147  $\mu$ A — 98  $\mu$ A) in the collector current. The beta of this transistor would be:

$$\beta = \frac{49}{1} = 49 \quad (22)$$

This is a fairly typical value.

Note that in the configuration employed to give current gain, the ground point was moved from the base to the emitter. This circuit is therefore called the *grounded-emitter configuration*, or *common-emitter<sup>2</sup> configuration*. It is roughly equivalent to the grounded-cathode configuration of a vacuum tube, but the analogy should be employed with caution. For example, it has already been pointed out that the impedance, looking into the base, is typically 2000 ohms, instead of the high impedance usual for a vacuum-tube grid.

Note also that signals and biases in transistors are described as currents, not as voltages, as is common in vacuum tubes. The gain (beta) which roughly corresponds to mu in a vacuum tube, is a *current* ratio, whereas mu is a *voltage* ratio. It is usually much more convenient, for transistor work, to describe the circuits in terms of currents, rather than in terms of voltages.

<sup>2</sup>In these articles, the prefix "common-" will be used in preference to "grounded-," since it is more general. For example, it is not unusual to have a common-emitter amplifier in which the emitter is not connected to ground.



### Characteristic Curves of Transistors

In the introduction to this subject, the transistor was presented as an extension of an ordinary junction diode. This same approach can be used to derive the characteristic curves of a typical transistor, which show very clearly the behavior that can be expected.

If we set up a laboratory experiment in which we apply several different reverse-biasing voltages to a junction diode, and measure the resulting currents,

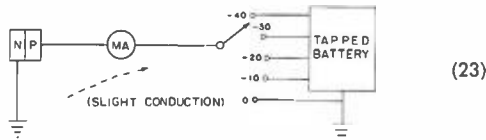

we can plot from the resulting data a curve showing the reverse-bias characteristic of a junction diode:

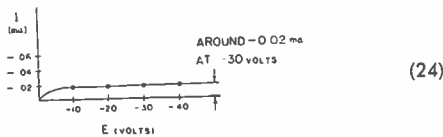

Simply extending this reverse-biased diode (to make it into a transistor) will not change the curve,

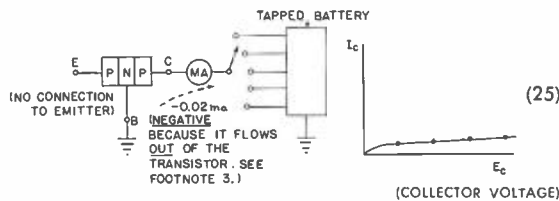

but forward-biasing the *new* junction (which is the way we establish transistor action) will cause a definite change in the curve, since the forward-bias current will flow through both junctions and appear in the circuit containing the milliammeter:

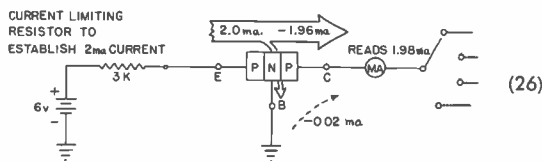

This additional current will displace the entire curve upward:

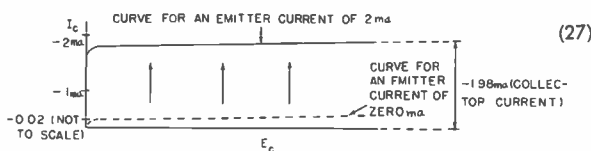

<sup>3</sup> Conventional network theory states, arbitrarily, that current flowing *into* a network is positive; current flowing *out*, negative. This convention is followed in these articles. It is also used in transistor data sheets.

If we choose a different value of emitter current—say 3.0 ma instead of 2.0 ma—the curve will be displaced upward even farther:

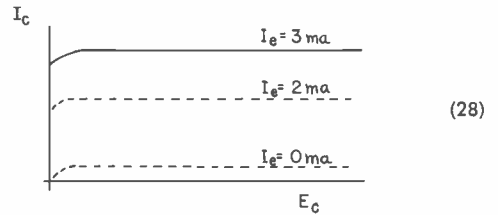

By selecting several different values of emitter current and showing a curve for each one, we can generate an entire family of curves:

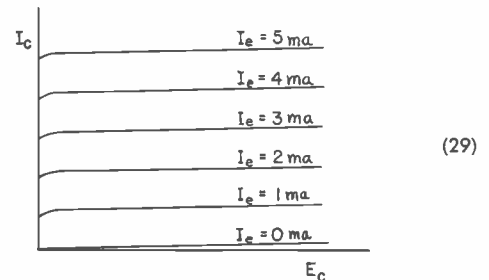

This family is typical of the curves found in data sheets.

You will note that these curves are drawn for a transistor operating with its base grounded:

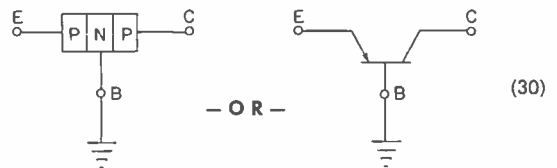

Therefore, these curves are called *common-base curves*, and an amplifier built using a transistor connected in this manner is called a *common-base amplifier*. These curves can be used to show the behavior of a common-base amplifier.

### Transistor Amplifier

Let us suppose that a piece of broadcast equipment contains this common-base transistor amplifier (using a PNP transistor):

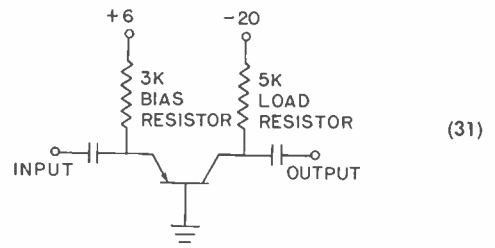

We wish to know how this amplifier is operating—what the bias is, how much collector current flows, how much power is

dissipated in the collector, and how much gain it will offer. All these facts may be ascertained by a simple construction on the common-base characteristics.

Start by drawing a load line on the characteristics. This construction is exactly the same as the corresponding construction on vacuum-tube characteristics. You will remember that a typical pentode in this circuit;

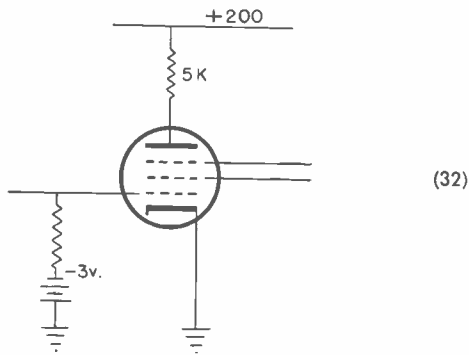

will have a load line connecting the 200-volt point and the 40-ma point, (the 40-ma point is obtained by dividing 200 volts by 5,000 ohms):

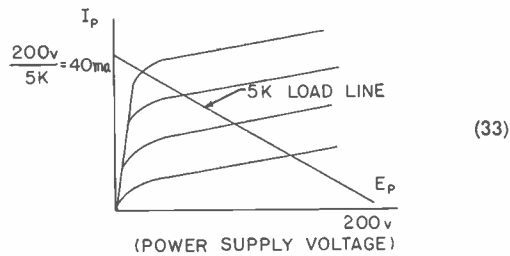

In an exactly similar manner, the load line for the common-base amplifier will be a straight line connecting the -20-volt point and the -4-ma point:

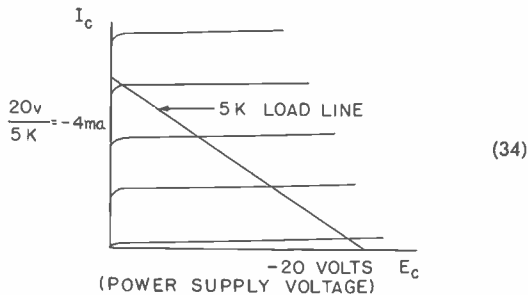

Just as for vacuum tubes, the operating point of the transistor amplifier must lie somewhere on its load line. For the pentode, the operating point lies at the intersection of the load line and the curve representing the particular bias chosen by the design engineer:

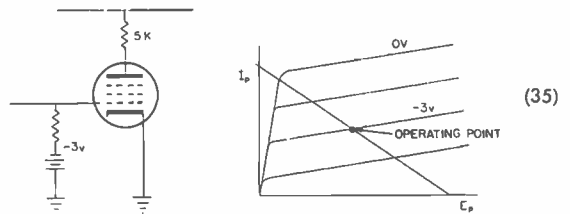

The bias for this transistor amplifier, however, is a *current*, not a voltage. The bias current is that current which the 6-volt supply can cause to flow in the series combination of the 3K resistor and the forward-biased emitter<sup>4</sup> junction:

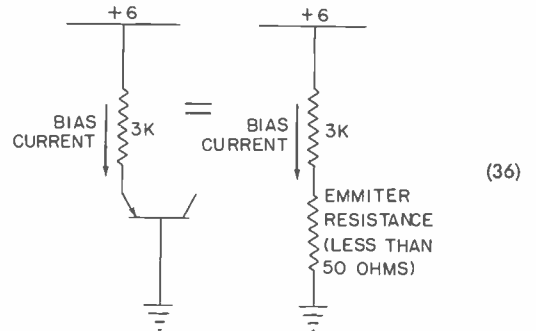

Since the emitter resistance is usually very small (less than 50 ohms), its resistance may be neglected in computing the bias current. The current is therefore:

$$I_b = \frac{6 \text{ volts}}{3,000 \text{ ohms}} = 2 \text{ ma} \quad (37)$$

which will put the operating point at the intersection of the load line and the 2-ma curve:

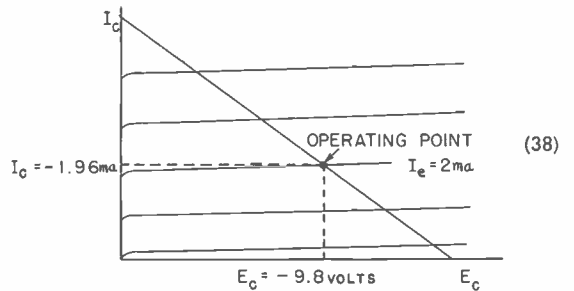

This transistor amplifier therefore operates with a bias current of 2 ma, a collector current of -1.96 ma, and a voltage at the collector of -9.8 volts:

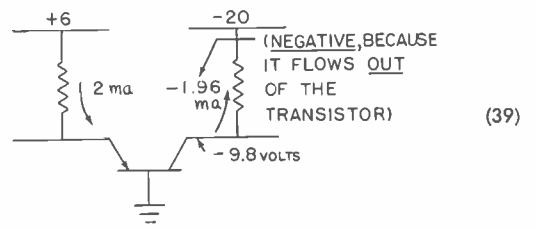

<sup>4</sup> The comparison of *grid* bias and *emitter* bias could confuse the reader into thinking the *grid* and *emitter* are equivalent. They are not; the comparison is used merely because the graphical constructions are similar. The *grid* corresponds to the *base*.

The power dissipated at the collector is given by the formula:

$$P = IE = (-1.96 \text{ ma}) (-9.8 \text{ volts}) = 19.2 \text{ milliwatts}$$

The gain of this amplifier depends upon whether it is being used to obtain voltage gain or current gain. Its voltage gain can be large; its current gain is always less than unity, that is, this amplifier produces current loss instead of gain. Its actual current gain is equal to alpha, about 0.98 for a typical transistor:

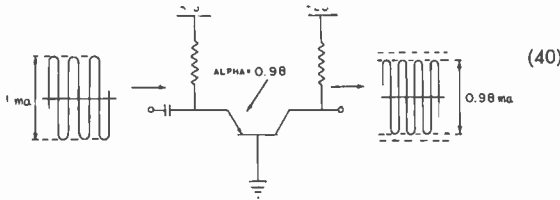

The *voltage* gain (the ratio of output to input voltages) can be calculated from the output and input impedances. The output impedance, in this case, is known to be a 5000-ohm resistor, but the input impedance was stated vaguely to be "less than 50 ohms." Fortunately, there is a simple way to calculate the input impedance (emitter resistance). It is given by the formula<sup>5</sup>:

$$R_e = \frac{25.6}{I_e} \quad (41)$$

In this formula  $R_e$  is the emitter resistance in ohms, and  $I_e$  is the emitter current in milliamperes. For the transistor amplifier in this example, the emitter is biased with 2 ma, so the emitter resistance is:

$$R_e = \frac{25.6}{2 \text{ ma}} = 12.8 \text{ ohms} \quad (42)$$

Now, knowing both input and output impedances, we can calculate the voltage gains. If a 1-ma signal flows into this amplifier, it will produce a 12.8 millivolt swing across the 12.8-ohm emitter resistance:

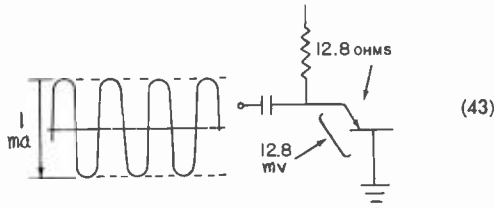

Almost all of the 1-ma signal current (98 percent of it) flows in the 5000-ohm load resistor, producing a 5-volt drop across it:

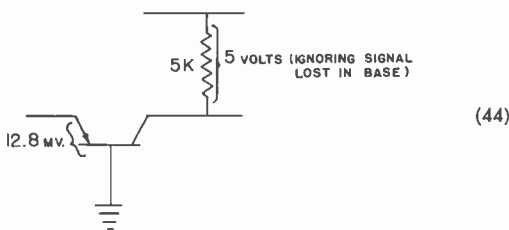

<sup>5</sup> This expression is derived from basic semiconductor physics. It can be shown that  $R_e = (kT/e)/I_e$ , where  $k$  is boltzman's constant,  $T$  is the absolute temperature, and  $e$  is the charge on an electron. Inserting proper values gives a value of 25.6 for  $kT/e$ , at 25 degrees C. This is a theoretical value subject to appreciable variation in practical transistors.

The voltage gain in this case is:

$$G_v = \frac{5 \text{ v}}{12.8 \text{ mv}} = \frac{5}{0.0128} = 391 \quad (45)$$

The same answer can be obtained by taking the ratio of the output and input resistances:

$$G_v = \frac{5,000 \text{ ohms}}{12.8 \text{ ohms}} = 391 \quad (46)$$

The same common-base amplifier, then, can provide a *voltage* gain of 391, but can give a *current* gain of less than 1. It is clearly to our advantage to use this type of amplifier as a voltage-gain device. But what makes the difference between a voltage amplifier and a current amplifier?

### Voltage vs Current Amplifier

The distinction between a voltage amplifier and a current amplifier is mainly one of convenience. A voltage amplifier is one whose input signal comes from a *constant-voltage source* (note, this term is defined below). When an amplifier is driven from a constant-voltage source, its input voltage is known or easily determined. If the output voltage is also known or easily determined (as it usually is), it is easy to take the output-to-input ratio, which gives the voltage gain. Under these circumstances, it is *convenient* to consider the amplifier as a *voltage* amplifier.

Similarly, if an amplifier's signal source is a *constant-current source* it is *convenient* to consider it as a *current amplifier*, for the ratio of input-to-output currents may be easily determined. This ratio gives its current gain.

### Constant-Voltage vs Constant-Current Sources

Practical approximations to constant voltage sources are familiar to almost everyone. A battery is a good example of a dc constant-voltage source. Consider this circuit:

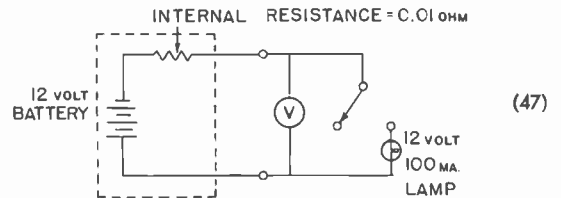

Note that a 12-volt storage battery lights a lamp when the switch is thrown. When the switch is open, the voltmeter reads 12 volts. When switch is closed and the lamp is connected, the voltmeter shows no perceptible change in voltage. Therefore, the storage battery is a constant-voltage source, for its output voltage does not change when the load is connected.

Constant-current sources are less common, but one can be synthesized for the purpose of explanation. Consider the following circuit:

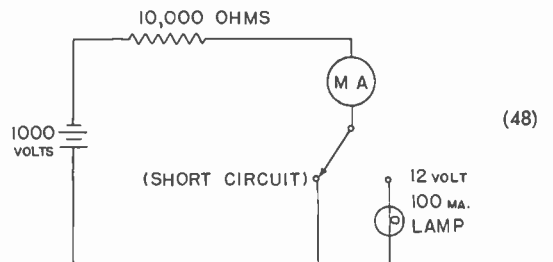



Note that a 1000-volt battery supplies current to a lamp when the switch is thrown.

When the switch is in the short-circuit position, the milliammeter indicates that 100 ma flows in the circuit. When the lamp is lit, the milliammeter shows no perceptible change in the 100-ma current. We therefore say that the battery-plus-resistor combination is a constant-current source, for its output current does not change when the short circuit is replaced by the load.

One can easily see that these "constant" sources are only *approximately* constant. How nearly constant they remain depends upon the relationship between their internal impedances and their respective load impedances. In practical cases, a source is called a *constant-voltage source* when its internal impedance is much less than the impedance of the load it feeds. Likewise a *constant-current source* is a source whose internal impedance is much *greater* than the impedance of the load it feeds. Inspect the two dc examples above, to verify these statements. (The 12-volt lamp has an impedance of 120 ohms.)

### Voltage vs Current Amplifiers

Through vacuum-tube experience, it has become the custom to think of *all* amplifiers as voltage amplifiers, since the grid of a vacuum tube makes almost any source look like a low-impedance (constant-voltage) source, by comparison:

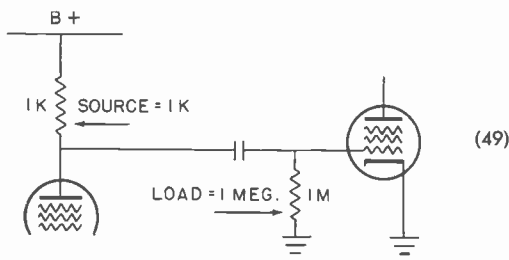

With transistors it is not always thus. If a common-base (CB) amplifier has an input impedance of 12.8 ohms:

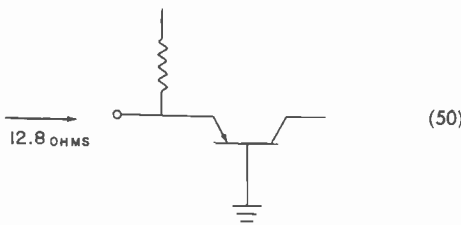

it must be fed from a source of even *lower* impedance in order to be conveniently classed as a voltage amplifier:

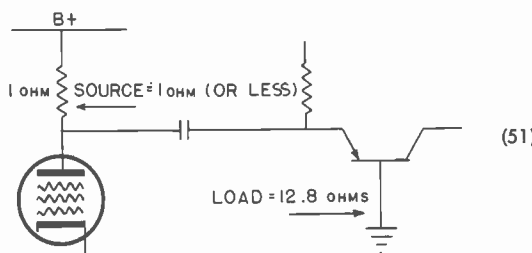

This is not always practical. Transformers may be used to obtain such low impedances in narrow-band or tuned amplifiers,

but wide-band amplifiers usually cannot make practical use of such an arrangement.

On the other hand, transistors are particularly well-suited for operation as current amplifiers. A transistor—especially in the common-base configuration—has such a low-impedance input that many sources are higher-impedance in comparison, and therefore are treated as current sources. Consider, as an example, the dc current source used as an example above, but with an ac signal in place of the battery:

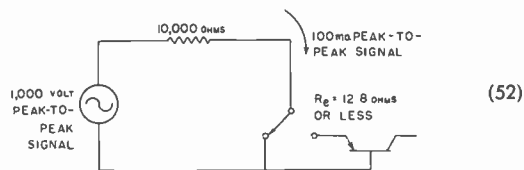

The impedance of the source—10,000 ohms—is certainly much greater than the impedance of the emitter.<sup>6</sup> A constant signal-current of 100 ma, peak-to-peak, will flow, without regard for the position of the switch. Driven thus from a constant-current source, the transistor may most easily be regarded as a current amplifier.

Unfortunately, this particular configuration does not give a useful current gain. With a 100-ma signal flowing into the emitter, only a 98-ma signal will flow from the collector (if  $\alpha = 0.98$ ). The common-base amplifier actually gives a current *loss* instead of a current gain.

We may summarize the behavior of a common-base amplifier thus: If a very low-impedance source is available, it will operate as a voltage amplifier, giving large voltage gains. Such sources are rather uncommon, however, particularly for wide-band amplifiers. If a moderately-high-impedance source is available, it will operate as a current amplifier, but will give a current gain of less than one, and hence is not useful.

In spite of such stringent restrictions, the common-base configuration is frequently used in a large variety of circuits. It will be seen acting as an impedance transformer, as a capacity isolator, or as a means of obtaining non-inverted gain from a tube. Examples of these three applications are given below.

### Transistor Application as Impedance Transformer

The CB configuration can be put to practical use in improving the gain obtainable from a delay-line driver. This application is an example of its use as an impedance transforming device. Consider the following circuit:

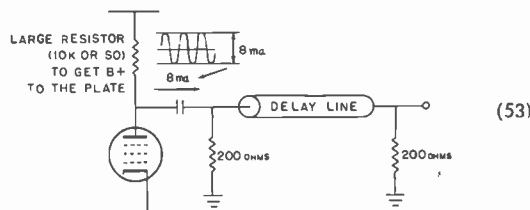

In this circuit a pentode drives an 8-ma peak-to-peak signal into a delay line which *must* be terminated in its characteristic

<sup>6</sup> The emitter resistance of 12.8 ohms was calculated for a bias current of 2 ma. To operate linearly with a signal swing of 100 ma, bias current would have to be at least 50 ma, which would give, by (40),  $R_e = 0.51$  ohms.

impedance of 200 ohms. The 8 ma will divide equally between the input termination and the output termination:

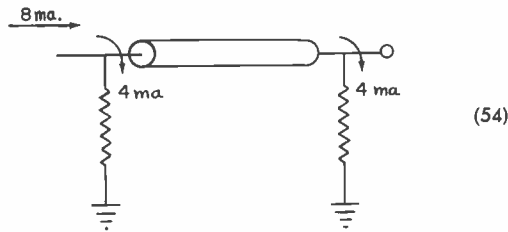

The 4 ma that flows at the output will result in an output signal of:

$$e_o = iR = (4 \text{ ma}) (200 \text{ ohms}) = 0.8 \text{ volts} \quad (55)$$

A considerable improvement in the output level can be made by inserting a transistor in this manner:

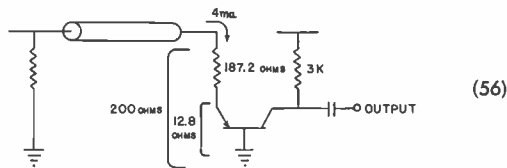

(Means of biasing are ignored to keep the picture uncluttered). In this case, the 4-ma signal flows through the transistor and appears (except for the two percent lost in the base, which we ignore here) in the collector circuit. The voltage output from this circuit is:

$$e_o = iR = (4 \text{ ma}) (3,000 \text{ ohms}) = 12 \text{ volts} \quad (57)$$

This is an *effective* gain of 15 over the first circuit.

#### Transistor Application as Capacity Isolator

A common-base amplifier as a capacity isolator, can also give an effective gain. Consider the following circuit:

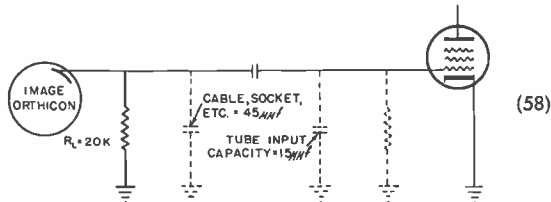

In this circuit a total of 60  $\mu\text{mf}$  of stray capacity shunts  $R_L$ , the 20K load resistor. If the stray capacitance were less, a larger load resistor could be used. The signal voltage available at the grid of the tube would then be greater, in direct proportion to the size of the load resistor. As the circuit now stands, however, 20K is about the largest practical value of load resistor.

Now, modify the circuit in this manner:

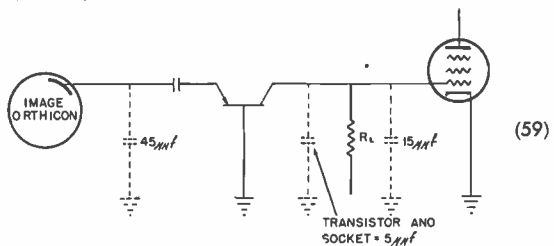

Note that only  $15 + 5 = 20 \mu\text{mf}$  appears across the load resistor. Since this is only  $1/3$  of the 60  $\mu\text{mf}$  of the first circuit,  $R_L$  can be 3 times as big, or 60K. The result is an *effective* gain of three.

#### Transistor Application for Preserving Signal Polarity

A common-base amplifier can also be used to preserve the polarity of a signal, whenever necessary. If a tube giving a gain of ten is required to amplify a pulse, the following circuit might be employed if an output signal of inverted polarity could be used:

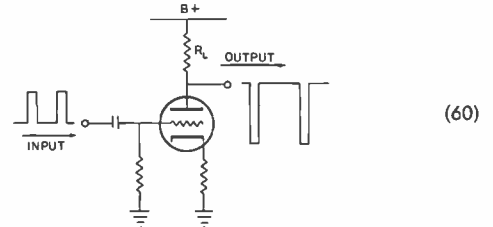

However, if a noninverted pulse is required, the above circuit cannot be used. (A noninverted pulse can be obtained at the cathode, but not at the required level.) To obtain a noninverted pulse of the required amplitude, a common-base transistor amplifier could be added in this manner:

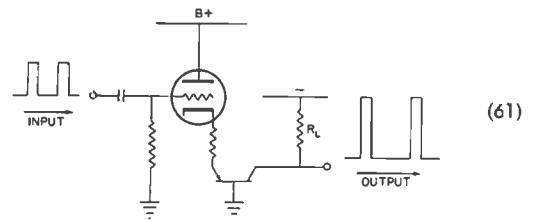

This circuit gives almost the same gain as the first circuit, and does not invert the signal.

#### Power Gain

A common-base transistor resembles a transformer in its ability to give voltage gain, but with an important difference. The difference lies in the transistor's ability to give a *power gain* as well. For example, consider a 10-to-1 step-up transformer in which the primary signal voltage and signal current are 0.2 volt and 10 ma, respectively:

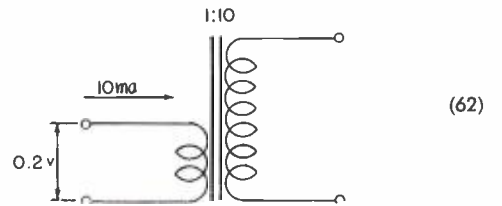

Then, the secondary voltage will be 10 times as great (2 volts) and the secondary current 1/10th as great (1 ma):

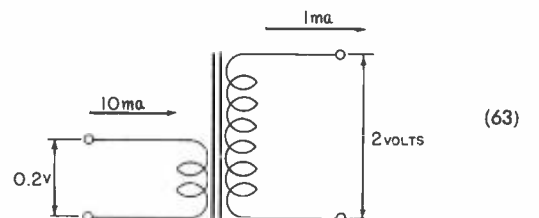

The power at the output, (neglecting losses) is the same as the power at the input:

$$P_{in} = E_{in} I_{in} = (0.2 \text{ volts}) (10 \text{ ma}) = 2 \text{ milliwatts} \quad (64)$$

$$P_{out} = E_{out} I_{out} = (2 \text{ volts}) (1 \text{ ma}) = 2 \text{ milliwatts}$$

Now, compare a transistor with similar input conditions as the 10-to-1 step-up transformer:

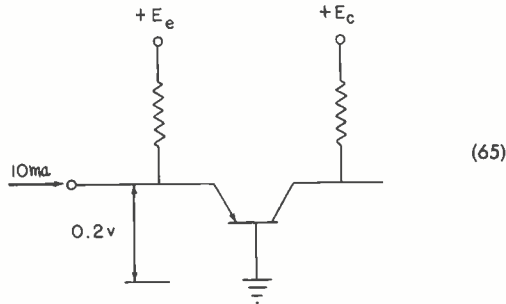

The transistor can be given a collector load which will give the same signal voltage gain as the 10-to-1 step-up transformer:

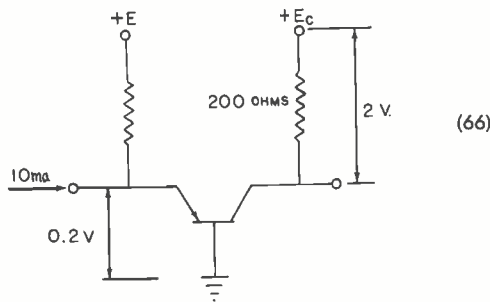

The signal current, however, at the output is not reduced proportionally, but instead is virtually the same as the input current:

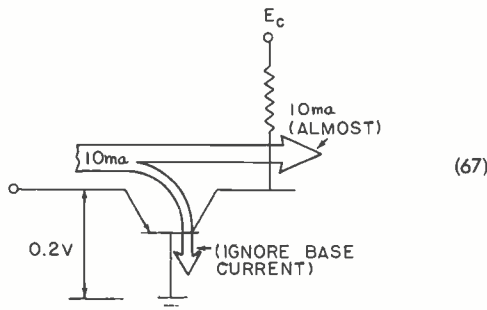

Therefore, the signal power at the output is ten times greater than at the input:

$$P_{in} = e_{in} i_{in} = (0.2 \text{ volts}) (10 \text{ ma}) = 2 \text{ milliwatts} \quad (68)$$

$$P_{out} = e_{out} i_{out} = (2 \text{ volts}) (10 \text{ ma}) = 20 \text{ milliwatts}$$

This power gain is a better indication of a transistor's gain capabilities than is *voltage gain* or *current gain*. Voltage or cur-

rent gain can be obtained from an ordinary transformer; power gain cannot.

### Maximum Voltages and Currents

The maximum collector voltage that can be applied to a transistor is limited by a phenomenon called *breakdown*. Consider this example in which the collector voltage is increased beyond a certain limit:

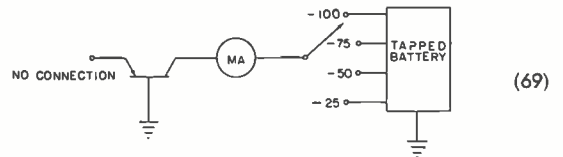

Then the collector junction will begin to pass an abnormally large current:

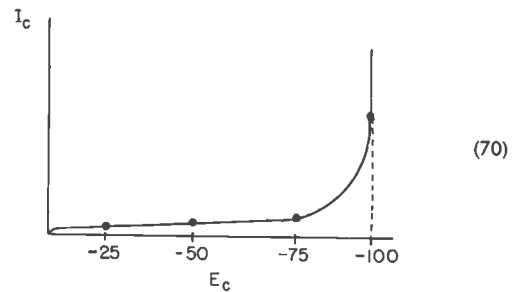

The voltage at which the curve breaks sharply upward is called the *breakdown voltage*. In this region, a transistor does not behave normally. To insure proper transistor action, the operating point must be well removed from the breakdown region.

A transistor will not *necessarily* be destroyed by breakdown. If a transistor rated at 200 milliwatts breaks down from over-voltage and, while in the breakdown region, dissipates 500 milliwatts, it will very likely be destroyed or at least damaged. On the other hand, a transistor may go into breakdown without being damaged at all if the circuit includes a series resistance to limit the maximum power to a safe value.

Breakdown defines the maximum allowable voltage. However, the maximum *current*, which bears no relation to the breakdown voltage, is not so well defined. At higher and higher currents, progressively smaller portions of the emitter current appear in the collector, with the result that alpha, which is around 0.98 at small currents, may become 0.6 or 0.5 or even less. The practical limit on high currents is reached when alpha falls below some arbitrary limit, set by the designer to fit the particular requirements of the circuit at hand.

Thus far the transistor has been introduced and its characteristics and uses as a common-base amplifier have been described. It has been pointed out that there are many restrictions on the common-base configuration which limit its usefulness. The next part in this series will describe a configuration which is not so limited—the common-emitter configuration. It will be shown how a common-emitter amplifier can provide both voltage gain *and* current gain, simultaneously, but at the expense of an inherently narrower bandwidth.



FIG. 1. An ultra-gain TV antenna is shown on a 15-ton turntable at the RCA Antenna Testsite.

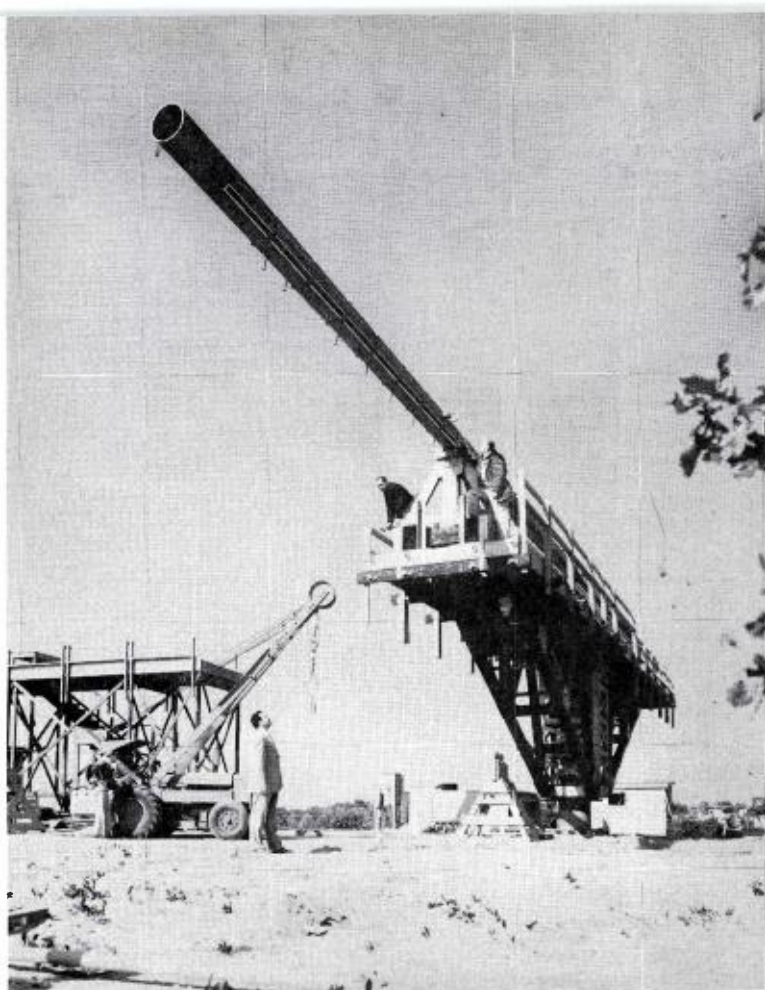

## THE RCA TEST FACILITIES FOR TV ANTENNAS

*Assure Accurate Measurement of Antenna Gain,  
Vertical Pattern, and SWR—Prior to Installation*

*by H. E. GIHRING, Manager, Antenna Engineering*

Accurate measurements on TV transmitting antennas are desirable in order to confirm antenna gain, circularity of pattern, vertical patterns and other important characteristics. Measurements made on full-scale antennas under the proper conditions yield the greatest accuracy. For this reason, full-scale antenna test facilities for making these measurements were developed by RCA several years ago. A pattern test site, near Gibbsboro, N. J., was chosen after numerous tests to determine its suitability.

Three turntables were installed to handle antennas up to 1, 3, and 15 tons.

These test facilities constitute an invaluable tool for the design of new antennas and for the testing of production antennas. Because of the ease with which patterns can be obtained, a great number can be taken in a single day, yielding a wealth of information for development purposes, assuring optimum designs. Furthermore, production tests are made on antennas

before shipment when requirements indicate that tests are desirable.

### **Antenna Theory**

An antenna radiates energy over the communities it is designed to serve just as the light rays radiate from a lighthouse. In a lighthouse a specially designed lens focuses the beam to prevent too much light from being radiated in upward or downward directions. This would be a waste

of energy, and it would detract from the light intensity in the main beam.

Similarly, in a television or FM antenna the beam is focused by stacking radiating elements. Slots can be cut in a pipe, above each other, to focus the beam into a desired pattern. If a vertical plane is passed through the vertical axis of the antenna and the intensity of radiation is represented by the length of the vector at each vertical angle, then the plot would be a vertical pattern. Similarly, a horizontal plane which passes through the center of radiation would delineate a horizontal pattern.

### Vertical Pattern

The radiating elements of an antenna can be fed with equal or different amounts of power. When the amount fed to each radiator is the same, the antenna is said to have "uniform amplitude illumination" or simply "uniform illumination." The phase of each radiating element can also be varied. For example, an antenna which has uniform amplitude illumination and all sources in phase will have a theoretical vertical pattern in which zero nulls occur. If the main beam of such an antenna with a gain of 6 is pointed toward the horizon, the first null will be located 9.6 degrees below the horizon. If the antenna were

placed on a 1000-foot tower over flat earth, the null will be located 1.1 miles from the base of the tower. Actually, the null never quite goes to the theoretical zero because of mechanical dissymmetries in the antenna. Experience has shown this filling to be of the order of several per cent which will usually produce an acceptable field strength at this close distance. Hence, antennas with a gain of 6 usually have uniform amplitude illumination and sources in phase unless the conditions are unusual.

For antennas having a higher gain, some positive means of eliminating pattern nulls are necessary. Consider, for instance, a calculated vertical pattern of an antenna with a gain of 36, shown in Fig. 3. If this antenna were placed on a tower 1000 feet above flat earth, low-field-intensity areas would occur about every  $1\frac{1}{2}$  miles up to 7.4 miles from the base of the tower. These low-field-intensity areas will be highly detrimental to coverage since the amount of fill which provides an adequate field intensity at one mile will usually not provide an adequate field intensity much beyond this point. If the null occurs in terrain where buildings or hills beyond the null are illuminated with a higher-field intensity, the reflected energy from these buildings or hills into the null area will cause echoes or ghosts in the picture.



FIG. 2. Author, H. E. Gihring, Manager Broadcast Antenna Engineering Group, alongside section of a UHF Antenna.

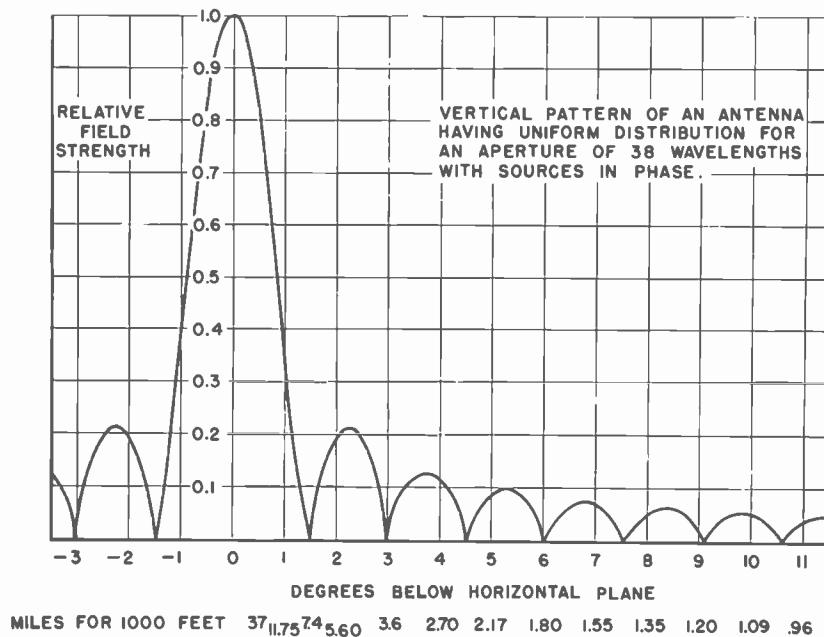

FIG. 3. This shows the vertical pattern for an antenna having uniform distribution and all sources in phase for an aperture of 38 wavelengths.

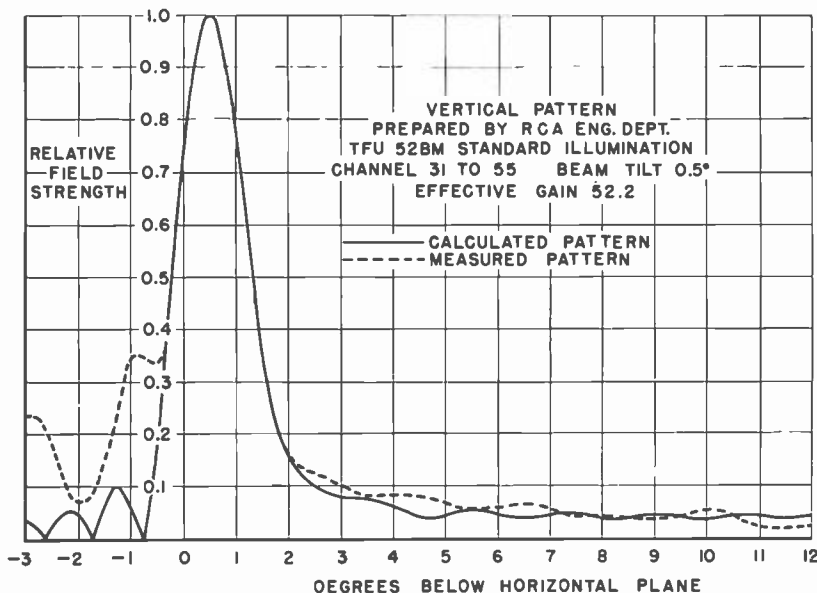

Fig. 4. The TFU-52BM antenna's calculated and measured patterns are shown here.

#### Antenna Gain

The general trend in antenna gain has been upward. The reason for this is primarily an economic one, since in general the cost of the transmitter plus the antenna to achieve a given effective radiated power is less when a higher-gain antenna is used. There are other factors such as terrain and ratio of transmitter power to antenna gain that must enter into this choice. As can be seen from Fig. 3, some special means must be used in a high-gain antenna so that it will produce a substantially uniform field strength over the service area. Some of these means are:

1. Varying the amplitude illumination in several steps. For example, the upper six sections of a twelve-section antenna may receive 30 per cent of the power, while the lower six sections receive 70 per cent of the power. This method is used in the twelve-section Superturnstile antenna<sup>1</sup> for channels 7-13 (TF-12AH), and in the medium-gain UHF antennas<sup>2</sup> (TFU-24D series).

<sup>1</sup> "New 50-kw VHF Superturnstiles," *Broadcast News*, Vol. No. 74, May-June, 1953.

<sup>2</sup> "A New UHF Television Antenna, TFU-24B," *Ibid.*, Vol. No. 68, March-April, 1952.

2. Varying the amplitude continuously over the aperture as in the RCA Traveling Wave Antenna<sup>3</sup>. A continuous variation in a prescribed manner will provide a null-free vertical pattern.

3. Variations in the relative phase of the radiators. The TF-12BH antenna<sup>4</sup> uses this method. This antenna is a variation of the TF-12AH antenna above, and was designed specifically to provide a large amount of fill-in at steep angles.

4. Variation of both amplitude and phase in a continuous fashion over the aperture. This is the method used in the RCA ultra-gain series of UHF antennas<sup>5</sup> having a nominal gain of 50 (TFU-46BL, TFU-52BM). This method not only provides a vertical pattern which will give a high uniform field strength over average terrain, but also suppresses radiation above the horizontal which serves no useful purpose. The energy thus conserved increases the aperture efficiency of the antenna. Figure 4 is a calculated and measured pattern of one of the ultra-gain antennas.

#### Testing Patterns of VHF and UHF Antennas

As can be seen from Fig. 4, the pattern produced by the antenna is a very important factor in providing good coverage.

<sup>3</sup> "Traveling Wave Antenna," *Ibid.*, Vol. No. 94, April, 1957.

<sup>4</sup> "The New TF-12BH High Gain Antenna," *Ibid.*, Vol. No. 78, March-April, 1954.

<sup>5</sup> "The Ultra-Gain High Power UHF Antenna," *RCA Engineer*, June-July, 1955.

FIG. 5. The 15-ton antenna turntable is shown in the background of this over-all view of the RCA Antenna Testsite.





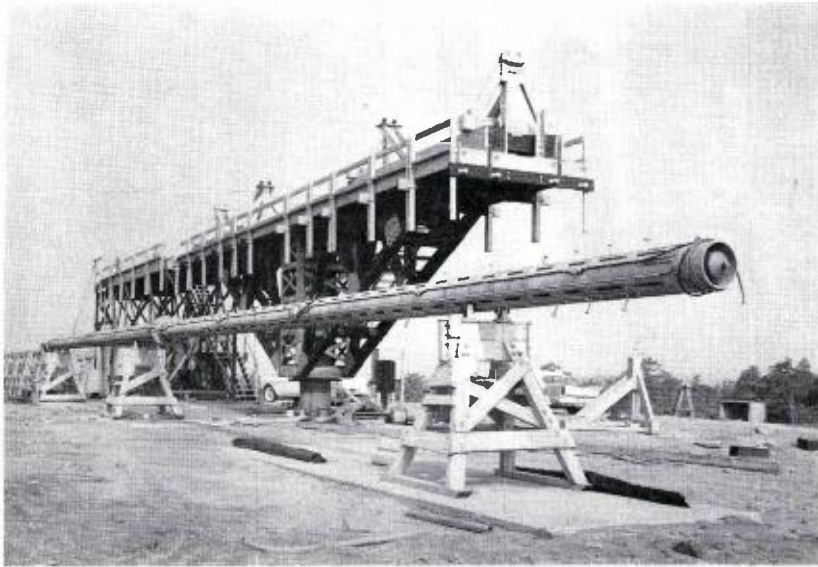

FIG. 6. A Type TFU-52BL UHF Antenna is shown next to the 15-ton turntable. This antenna has a gain of 52, and is 106.5 feet long.

RCA has built an antenna pattern test site near Gibbsboro, New Jersey,<sup>6</sup> in order to obtain assurance that antennas are performing in accordance with calculations.

Gains and the vertical patterns are determined by measuring the power flow through a sphere.<sup>7</sup> A close approximation is obtained by measuring the vertical pattern in eight planes and the horizontal pattern. The vertical pattern is measured

by placing the antenna in a horizontal position on a turntable. A signal is then transmitted from a point several miles away. The antenna under test is used as a receiving antenna, thus the antenna and the pattern recorder are at one location. By rotating the antenna in a horizontal plane, a vertical pattern is traced on the recorder. Since the antenna is at right angles to its usual transmitting position for this test, the transmitted signal must also be polarized at right angles.

Caution must be exercised in this type of measurement to avoid various errors due to reflections from objects, ground reflec-

tions, etc. Before the site was chosen tests were made to determine its suitability.<sup>8</sup>

The accuracy of the Gibbsboro site has been tested under varying conditions. After taking a 360-degree vertical pattern, the antenna is rotated 180 degrees on its long axis and the pattern repeated. Thus the energy from the transmitter to a given plane on the lower end of the antenna, for instance, travels over a different path for the two conditions. This will reveal the existence of reflections or other anomalies. Good pattern correlation has been obtained when this is done. Patterns have also been repeated when taken under wet and dry conditions.



FIG. 7. Here two halves of a high-gain antenna are being assembled at the test site. Note crane which is part of normal equipment complement.



FIG. 8. This transmitting tower at Union Mills, located 2.4 miles from the turntables, emits the test signals.

#### Antenna Handling Equipment

Three turntables were constructed to handle antennas of 15 tons, 3 tons and 1 ton respectively. The first one was located on the southernmost hill (see Fig. 5) and the other two on the northernmost hill 800 feet removed. Figure 6 is a close-up view of the 15-ton turntable on which antennas up to 130 feet long are tested. A crane for handling the antennas (see Fig. 7) is kept on the site at all times. The antennas are rotated at speeds up to one rpm by a thyatron-controlled d-c motor and a gear-reduction drive. Signals at required frequencies are transmitted from an 80-foot tower at Union Mills, 2.4 miles away. This distance was chosen so that for the longest antenna in the UHF band, the rays would be substantially parallel. Measurements taken at shorter distances could give a false picture of the fill-in achieved. Figure 8 shows this tower on which various transmitting dishes and corner reflectors are located for both VHF and UHF. The shack below contains oscillators which can be turned on and off and varied in

FIG. 9. As patterns of the antennas are measured they are continuously recorded as shown here. The speed and rotation of the turntables are also controlled from this location.



frequency by remote control from the turntable location.

Figure 9 shows the recording equipment in which the chart is driven by means of selsyns to produce a continuous recording. All three of the turntables are similarly equipped.

In the valley between the two hills there is a building which is used as headquarters for the operation. Most of the assembly and impedance work is done in this area (see Fig. 11). The building also contains a small machine shop and office.

The scrub pine and vegetation in the transmission path acts as a fairly good absorber for energy that would normally be reflected from the ground. This condition aids in the accuracy of measurements.

These facilities are the most extensive of this type in this country and probably in the world and represent a major step forward in furnishing the broadcast industry with antennas which are carefully engineered and tested to render the best service that can be achieved.



FIG. 10. Scale model of a Multiple Antenna arrangement, employing three superturnstile, undergoing test.

FIG. 11. This shows impedance tests being made on a high-gain antenna. The building is located in the valley between the two hills on which the turntables are placed.

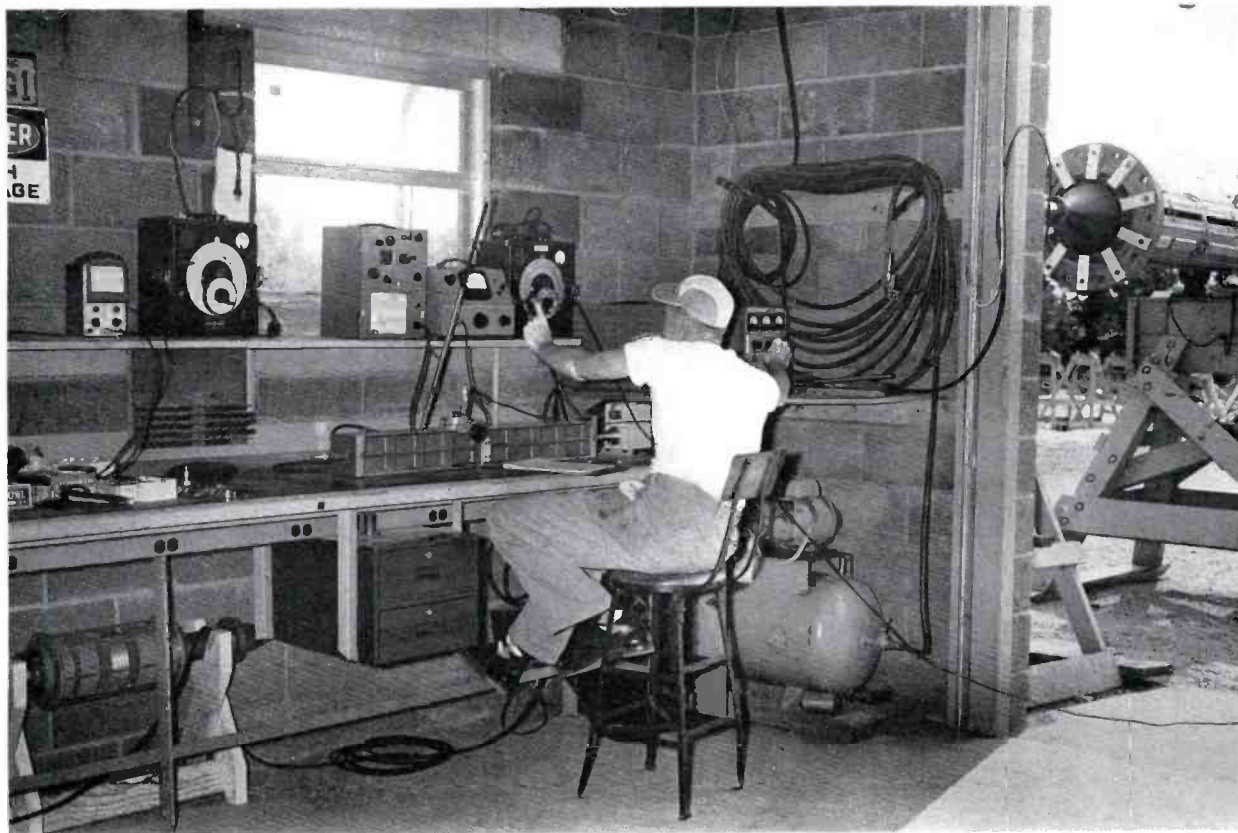



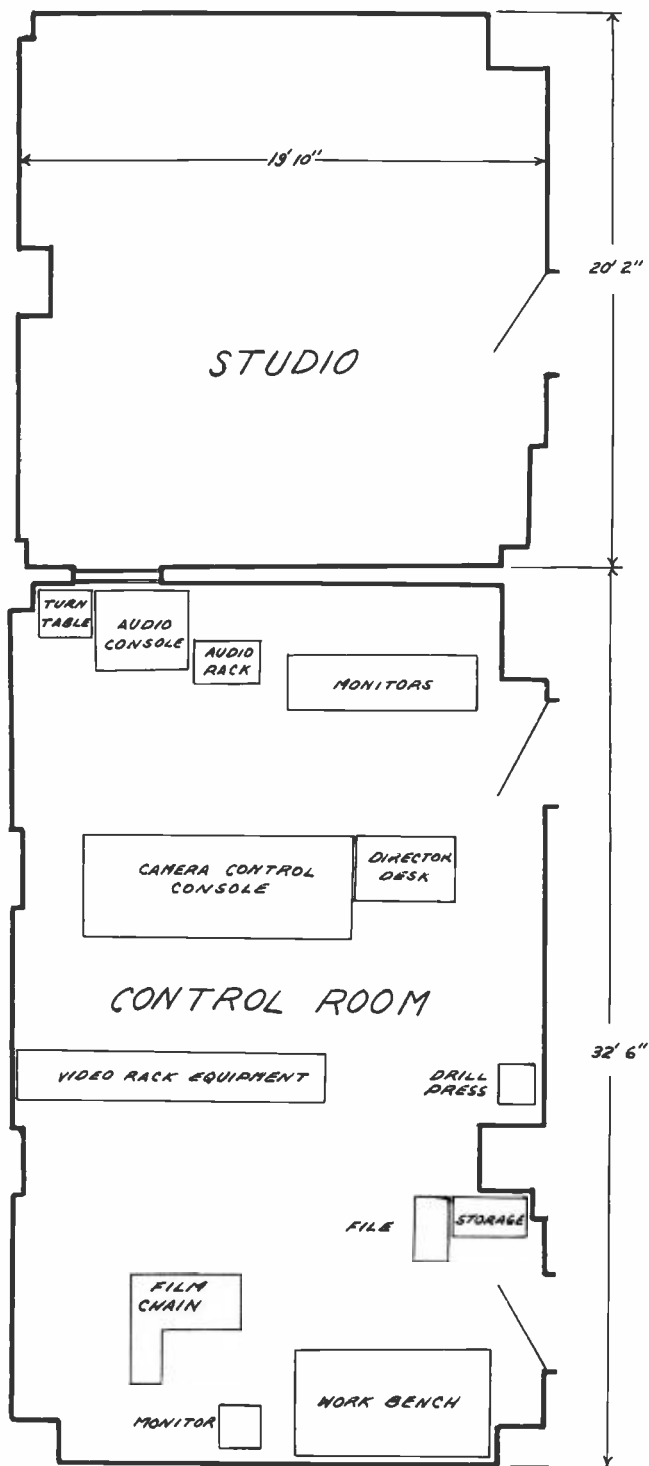

FIG. 1. Floor plan of studio and control room at University of Michigan Hospital, Ann Arbor, Michigan.



FIG. 2. Dirk Freeman and Warren Happel, engineers, and Lawrence Griewski, studio technical supervisor, examine TK-45 Color TV Camera before final installation.

## UNIVERSITY OF INSTRUCTION

*Closed-Circuit Compatible Color TV System'*

An RCA color TV system, housed at University of Michigan Hospital on the Ann Arbor campus, is being operated by the Medical Center and the University Television Office. Michigan has already had considerable teaching experience with monochrome TV and has now begun limited demonstrations with its color system. The new TV setup will be used for teaching surgical and clinical procedures to undergraduate, graduate and postgraduate students in the Medical Center.

The installation involves approximately \$170,000 of RCA equipment and was made possible by a grant from the Herbert H. and Grace A. Dow Foundation, Midland, Michigan.

### Television Equipment

The initial installation of television equipment consists of three color television cameras (TK-41, TK-45 and TK-26) and

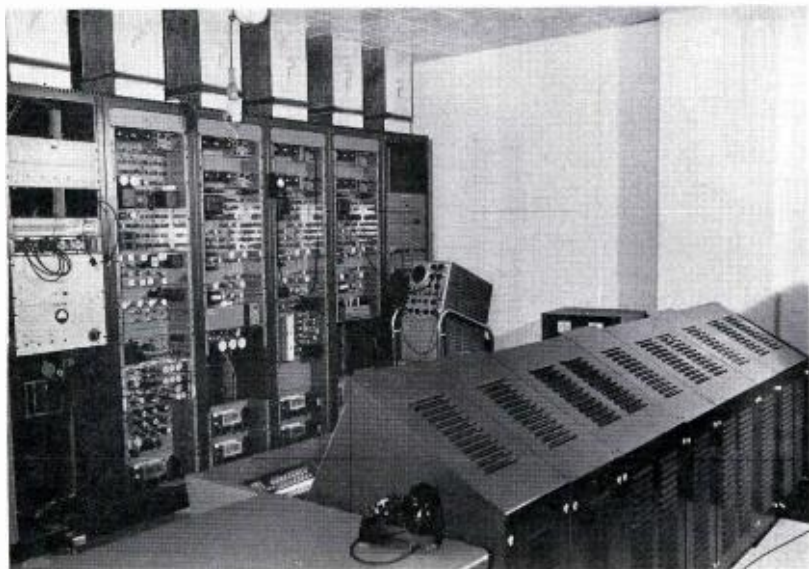

FIG. 3. Control room rack equipment showing (left to right): (1) video and audio patching and distribution; (2) synchronizing equipment and pulse distribution; (3) TK-41 rack equipment; (4) TK-45 rack equipment; (5) TK-26 rack equipment and (6) test equipment rack.



FIG. 4. Warren Happel, University of Michigan television engineer, inserts slides in TP-3 Projector. Also visible is the TK-26 Camera, TP-6 Projector and TP-15 Multiplexer.

# MICHIGAN BEGINS MEDICAL WITH RCA EQUIPMENT

*Gift of Dow Foundation, Is Installed in Medical Center*

one portable black-and-white television camera (TK-35). One color camera (TK-41) usually will remain in the studio for use in nonsterile demonstrations of various types. The studio has been equipped with lights and microphone boom, and is air conditioned.

The second color camera (TK-45) is being installed permanently in an operating room (on the floor above the studio and control room). This camera is mounted on the ceiling and is completely remote controlled. It has been designed to be as inconspicuous as possible so that it will not interfere with normal surgical techniques. Live pickups of surgical procedures and demonstrations are thus possible direct from the operating room.

## Color Film Camera

The third color camera (TK-26) is being used to reproduce motion-picture

films, color slides and other forms of graphic materials. These can be integrated into demonstrations involving the other cameras.

The portable black-and-white camera (TK-35) is being used for microscopic demonstrations and X-ray evaluations, where color is not required.

## Receiving Locations

A large amphitheater and two classrooms are being equipped as viewing rooms. Five RCA Victor 21-inch, compatible color, home-television receivers are installed. Five other similar receivers are located in the control room.

## Color TV Benefits

Dr. Albert C. Furstenberg, Dean of the Medical School, said that compatible color television will enable the University of Michigan Medical School to provide stu-

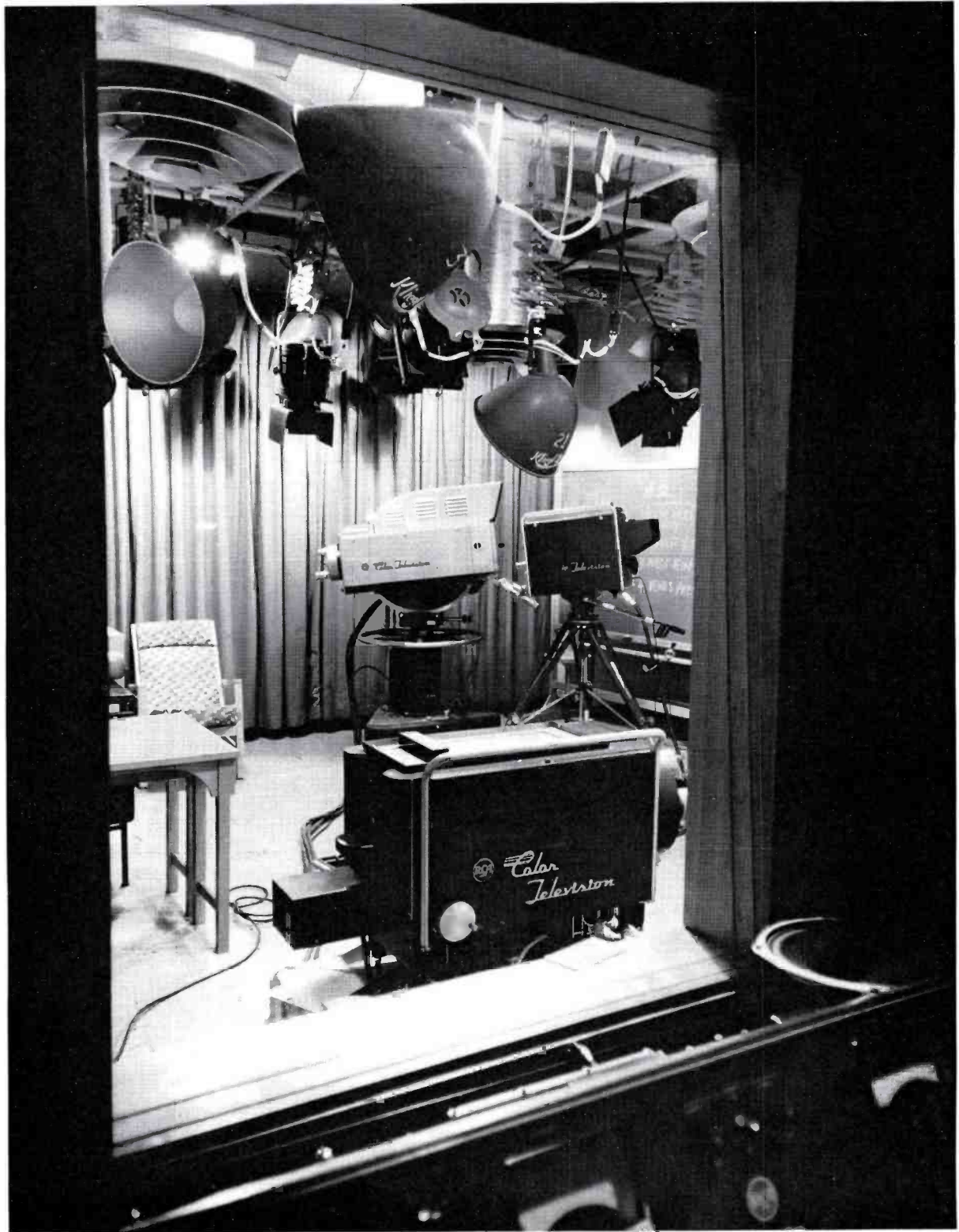

FIG. 5. View into studio from control room window with audio console visible in foreground. Through window is the TK-45 3-V Live Color Cameras which will be installed in a ceiling fixture in one of the operating rooms of the Medical Center. At center background is the TK-41 Color Camera while the TK-35 Camera is at the right.



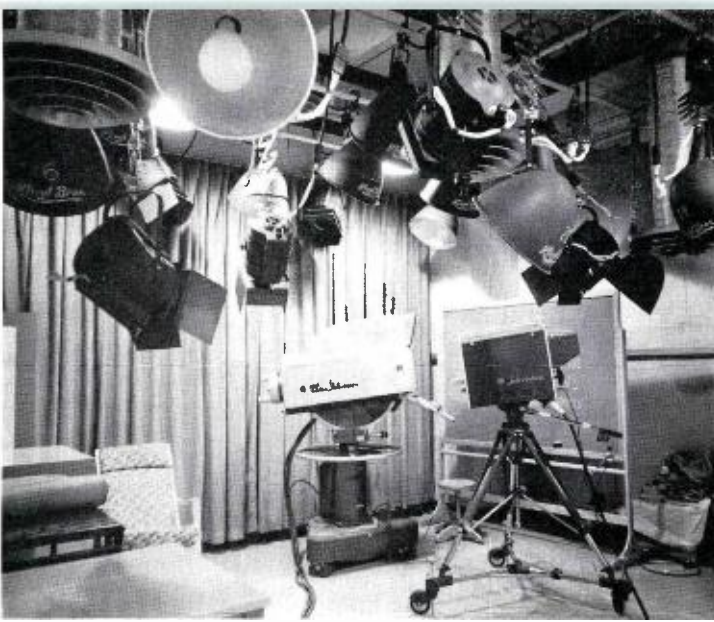

FIG. 6. General view of studio with the TK-41 at left and the TK-35 at right.



FIG. 7. View of front of control room showing camera controls and switching equipment, (left to right): (1 and 2) TK-26; (3 and 4) TK-45; (5 and 6) TK-41; and (7) TS-11 Switcher. Director's table is at right. Audio equipment is in left background and five color receivers used by directors are at right.

dents with new levels of realism, detail, and immediacy in visualization of surgical and clinical procedures.

"The application of closed-circuit color television to surgical instruction will enable large numbers of students to 'stand' at the surgeon's shoulder: to see what he sees, to observe each precise movement of hands, fingers and surgical instruments." continued Dr. Furstenberg.

Installation and technical operation of the cameras are being handled by engineers from the University Television Office, supervised by Frederick M. Remley, Jr., technical director, and Professor Garnet R. Garrison, director of broadcasting.

#### Previous TV Experience

The University of Michigan was among the nation's first educational centers to install black and white broadcast-type TV equipment, which is being utilized for production of kinescope films. The University is currently using an RCA closed-circuit monochrome system with four studio cameras. Its productions are used by stations throughout Michigan and across the nation.

Dean Furstenberg pointed out that the University's successful application of its initial monochrome system established the validity and effectiveness of closed-circuit television as an educational medium.

#### The Future

Dr. Harry A. Towsley, associate director of the Department of Postgraduate Medicine and chairman of the Medical School's TV Committee, foresees that the color TV installation can be employed for a number of purposes in addition to the closed-circuit sessions at the hospital. Since the system is a compatible one, surgical operations conducted on the closed-circuit for medical students could be broadcast from the hospital and ultimately viewed far outside of Ann Arbor. Dr. Towsley also feels that it might be possible to organize a medical circuit on a state-wide basis or even expand this to include viewing by national groups.

# Planning a Radio Station ?

*To be "in the know" about equipment installation and maintenance... enlist the know-how of professionals!*

Equipment for a radio station often represents a substantial and long-term investment. Proper installation and regular maintenance can lengthen equipment life, and assure a greater return on this investment. Hence, the importance of this new brochure, which outlines procedures suggested by experienced engineers for installing and servicing of radio broadcast stations.

Typical installation and maintenance practices for transmitters, towers, transmission lines, ground systems and studio equipment are covered in detail.

It shows you how to install directional and non-directional antenna systems; ground systems; how to check delivery and install the transmitter and the control room equipment. Regardless of the type or size of installation you will find this brochure very helpful.

Get your free copy of "Suggested Installation and Maintenance Procedures for a Radio Station." Write to RCA, Department K-22, Building 15-1, Camden, N. J. In Canada, RCA VICTOR Company Limited, Montreal.

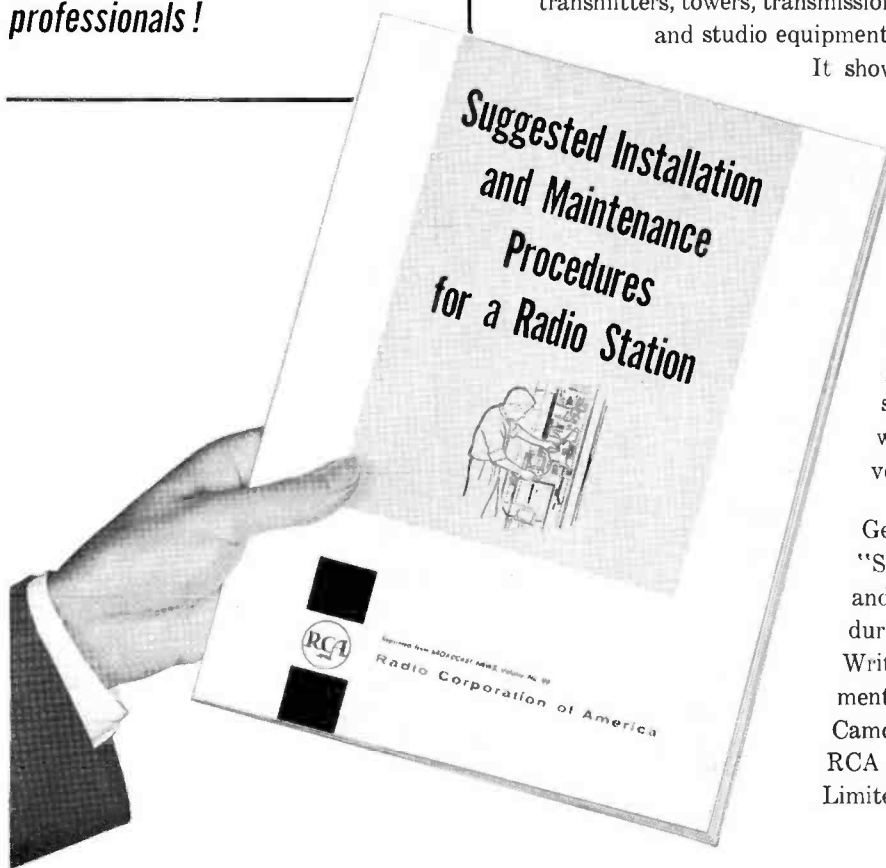

**RCA** ... your first source of help in station planning



Tmk(s) ®

**RADIO CORPORATION of AMERICA**

BROADCAST AND TELEVISION EQUIPMENT

CAMDEN, N. J.

# NEW

## RCA 500- AND 1000-WATT AM TRANSMITTERS pace the latest trends!



New BTA-500R/1R 500- and 1000-watt transmitters in a choice of colors: red, blue, green, and dark umber gray.

The design philosophy behind these new broadcast transmitters is based on years of experience in developing the most reliable of broadcast transmitters, but the features are radically new. Simplified tuning, reduced installation time, and built-in provision for remote control are some of the improvements. Also included in the design are provisions for remote Conelrad switching.

### NO NEUTRALIZATION REQUIRED

Tetrodes throughout simplify the tuning.

### BUILT-IN PROVISION FOR REMOTE CONTROL

Terminal strips are provided in the transmitter for connection of a remote-control unit.

### BI-LEVEL MODULATION

The very low order of distortion results in improved soundability.

### FEWER TUBES

Smaller tube inventory means reduced cost of operation.

### ACCESSIBILITY

Vertical construction permits easy access for maintenance.

### SIMPLIFIED TUNING

Only one tuning control—on the front panel. All operating controls are conveniently located on front, at both sides of door.

### FUNCTIONAL COLOR STYLING

Fits into any surroundings through choice of color for doors—blue, green, red or gray.

### EASE OF ACCESS

All tubes can be reached from the front by merely opening the door. Access to the rear is provided through two interlocked panels behind the transmitter. These panels are easily removed with thumbscrew fasteners. Typical RCA vertical construction permits easy access and maintenance. Removable base makes the transmitter easy to move.

### NEW OSCILLATOR

Three switchable temperature controlled crystal units, a spare on the main frequency, plus one for automatic Conelrad switching are incorporated in the new crystal oscillator of both transmitters. Six thumbscrews hold the etched oscillator-buffer circuit board to the exciter subassembly. All oscillator and buffer connections are made through a plug type terminal strip. Frequency stability is  $\pm 5$  cycles for the new RCA crystal units.

### SIMPLIFIED POWER INCREASE

The exciter unit is the nucleus of the basic transmitter; all low-level rf and audio stages are built into a single unit used in both 500- and 1000-watt transmitters. Thus, power increase is made easier.

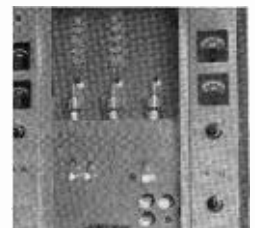

Tmk(s) ©

For further information about these and other transmitters, call the nearest RCA Broadcast Representative. In Canada call: RCA VICTOR Company Limited, Montreal.

## RADIO CORPORATION of AMERICA

BROADCAST AND TELEVISION EQUIPMENT  
CAMDEN, N.J.





## FOR QUALITY CONTROL OF COLOR PROGRAMMING

... TV Stations Rely on the TM-21 Color Monitor

Watchdog of color quality and performance, this RCA Color Monitor has become the *reference standard* for evaluating the quality of color television pictures from any source.

Easy to align, and stable over long periods of time, the TM-21 offers the following important advantages:

- Accurately reproduces the scene as the camera sees it.
- Shows the most precise and brilliant color pictures available.
- Provides extra stability in brightness, contrast, decoder, convergence, and linearity circuits.
- Basic instrument for checking registration, shading and deflection linearity . . . color fidelity of the entire TV system . . . chroma to monochrome ratio . . . color phase or hue adjustments.

To keep close watch on color television pictures, you'll find many uses for the RCA TM-21 Color Monitor. Call your RCA Broadcast Representative for full technical details.



**RADIO CORPORATION OF AMERICA**  
 BROADCAST AND TELEVISION EQUIPMENT  
 CAMDEN, N. J.